



**THE DATASHEET OF  
JZ030**



CONFIGURATION TABLE (SEE NOTE 6.1)						
PART NUMBER	C MIN [pF]	C MAX [pF]	TC [PPM/°C]	Q MIN. @ 1 MHz	MARKING COLOR	ALTERNATE COLOR
JZ030	1.5	3.0 +50% / -0%	0 ± 200	500	BLACK	BLACK & GREEN
JZ060	2.0	6.0 +50% / -0%	0 ± 300	500	BLUE	BLUE & GREEN
JZ100	2.0	10.0 +100% / -0%	0 ± 300	500	WHITE	WHITE & GREEN
JZ150	3.0	15.0 +100% / -0%	0 ± 500	500	PINK	PINK & GREEN
JZ200	4.5	20.0 +100% / -0%	0 ± 500	500	RED	RED & GREEN
JZ300	5.5	30.0 +100% / -0%	-1500 ± 1000	200	ORANGE	ORANGE & GREEN
JZ400	8.0	40.0 +100% / -0%	-1500 ± 1000	200	YELLOW	GREEN OR YELLOW & GREEN
JZ500	8.0	50.0 +100% / -0%	-1500 ± 1000	200	GREEN	GREEN & GREEN

**NOTES:**

- INTERPRET DRAWING PER ANSI Y14.5M-1994.
- [ALTERNATE DIMENSIONS]** ARE IN MILLIMETERS.
- ELECTRICAL SPECIFICATIONS:
  - CAPACITANCE RANGE: *SEE CONFIGURATION TABLE.*
  - DC WORKING VOLTAGE AT MAX. RATED CAPACITANCE: 125 [VOLTS].
  - DC WITHSTANDING VOLTAGE AT MAX RATED CAPACITANCE: 220 [VOLTS].
  - Q FACTOR AT 1 [MHz] AND MAX RATED CAPACITANCE: *SEE CONFIGURATION TABLE.*
  - INSULATION RESISTANCE: 10<sup>4</sup> [MEGAOHMS] AT 25°C.
  - TEMPERATURE COEFFICIENT: *SEE CONFIGURATION TABLE.*
  - SELF RESONANT FREQUENCY MEASURED AT MAX RATED CAPACITANCE
- MECHANICAL SPECIFICATIONS:
  - TUNING TORQUE: 0.14 [in·oz] TO 1.00 [in·oz].
  - ALL PARTS FURNISHED ON 12 [mm] TAPE AND REEL; 1000 PIECES PER REEL.
- ENVIRONMENTAL:
  - OPERATING TEMPERATURE: -40°C TO +85°C.
  - RoHS COMPLIANT.
- MISCELLANEOUS:
  - IN ORDER TO PROVIDE THE HIGHEST LEVELS OF SERVICE, KNOWLES RESERVES THE RIGHT TO SUPPLY EQUIVALENT PRODUCTS WHERE SPECIFICATIONS ARE EQUIVALENT OR ENHANCED. THIS INCLUDES SUBSTITUTION OF JZ500 TO JZ400 AND HV SUFFIX FOR STANDARDS PARTS.

REVISION HISTORY				DRAWN	APPROVED
ECO#	ZONE	REV	DESCRIPTION	ASJ09/17/09	AG
			REDRAWN		
1392	ALL	D	JZ500 ADDED; UPDATED TO CURRENT STANDARDS AND LATEST SPECIFICATIONS	ECJ11/26/14	TDJ12/04/14
1474	TAG	E	NOTE 6.1 ADDED. SUBSTITUTIONS OPTIONS DETAILED	ECJ12/09/15	TDJ11/02/16
1607	TAG	F	SPECS MATCHED TO CURRENT SALES BROCHURES (NOTES 3.2 & 5.1)	ECJ05/12/17	
	ALL	G	REMOVED JZ080	MIJ03/23/22	MIJ03/23/22

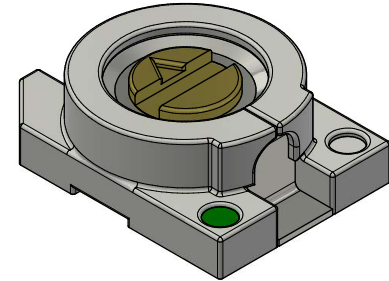

ISO VIEW  
SCALE 20 : 1

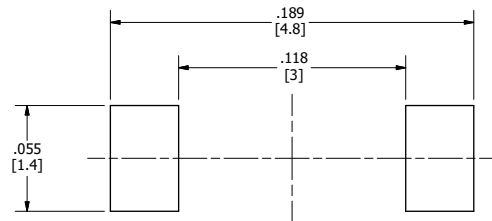
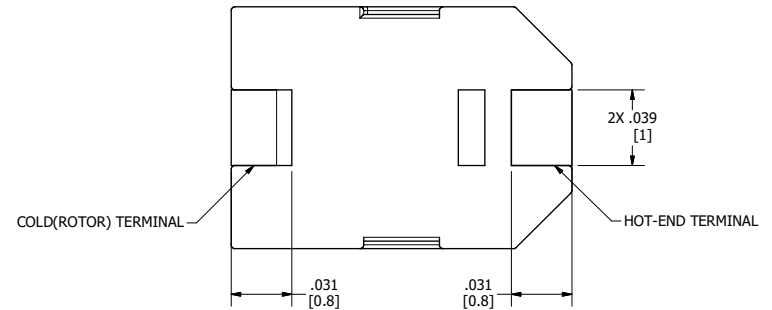
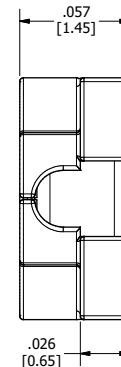
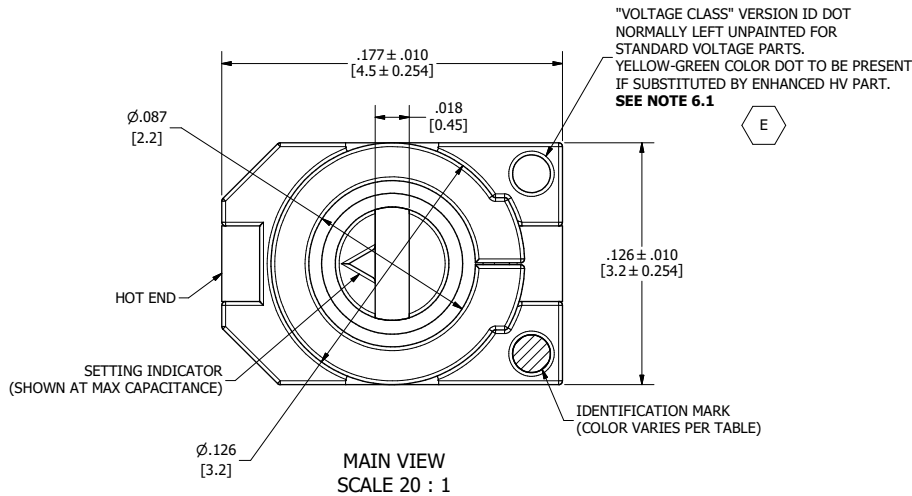

**SUGGESTED FOOTPRINT**  
SOLDER PASTE THICKNESS OF 0.15 [mm] RECOMMENDED  
SCALE 20 : 1

MATERIAL	N/A	DRAWN	E. CONTRERAS	11/26/2013	 VOLTRONICS THE TRIMMER CAPACITOR COMPANY 2250 NORTHWOOD DRIVE SALISBURY, MARYLAND 21801	
FINISH	N/A	CHECKED	T. BYRNE	12/10/2014		
TOLERANCES	XX ± XXX ±.008 XXXX ± X° ± 1° X.X° ± 0.1°	SURFACE FINISH	32	QUALITY ASSURANCE	G. SATTERFIELD	12/12/2014
3RD ANGLE PROJECTION		ENGINEERING	F. KHALIFEH	12/1/2014	MANUFACTURING	
		ENGINEERING	T. DOLAN	12/4/2014	CUSTOMER PART NUMBER	
		INVENTOR 2013 GENERATED DWG			SIZE	C
					CAGE CODE	55153
					PART NUMBER	JZxxx
					REV	G
					SCALE	PER VIEW
					DWG NO.	V-7531
						SHEET 1 OF 2

4

3

2

1

SECTION A-A  
SCALE 8: 1

$.012 \pm .005$   
[ $0.3 \pm 0.127$ ]

$.091 \pm .005$   
- $.000$   
[ $2.3 \pm 0.127$ ]  
- $0.000$ ]

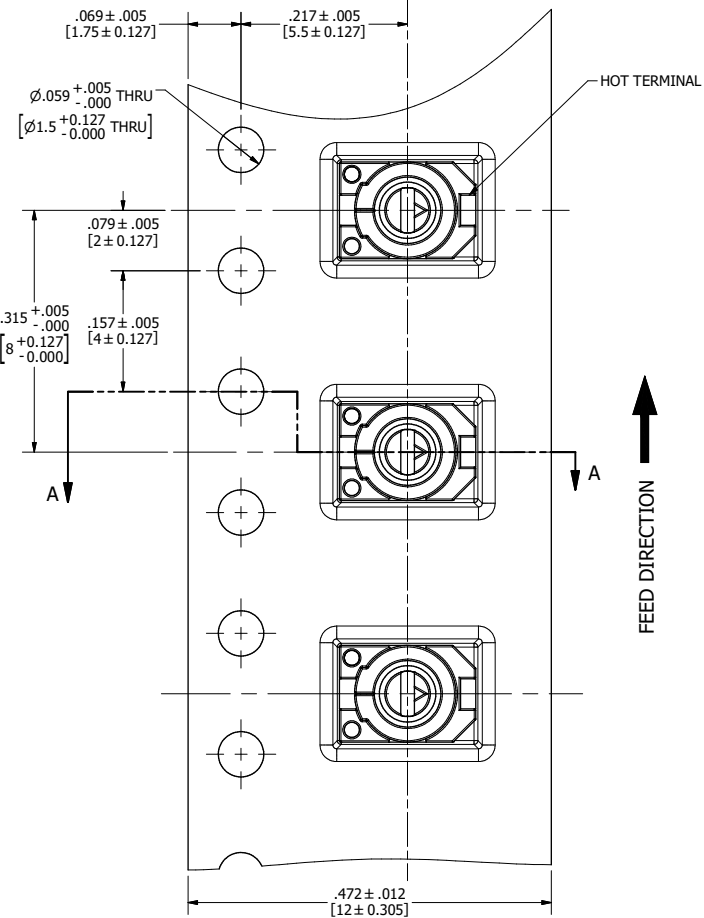
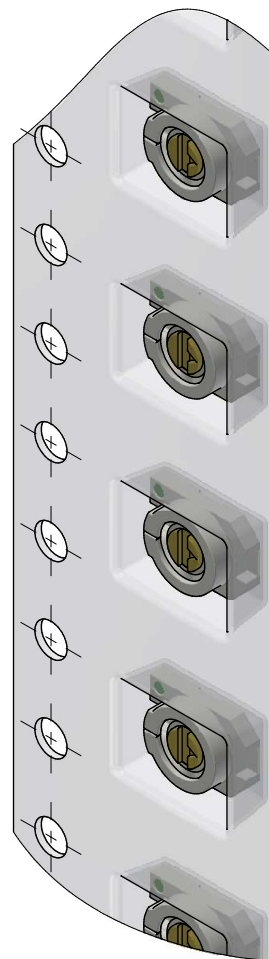
CARRIER TAPE DETAIL  
SCALE 8: 1CARRIER TAPE  
ISO VIEW  
SCALE 8: 1

## HANDLING/STORAGE PRECAUTIONS:

- i.- DO NOT USE FLOW SOLDERING.
- ii.- DO NOT APPLY SOLDER OR FLUX TO ANY PARTS BUT TERMINAL
- iii.- WHEN USING SOLDERING IRON, THE SOLDERING IRON SHOULD NOT COME IN CONTACT WITH THE HOUSING OF THE CAPACITOR.
- iv.- PLEASE REFER TO SOLDER RECOMMENDATIONS CHART.
- v.- NO-CLEAN METHOD IS PREFERRED OVER SOLVENT WASHING. EXPERIMENT WITH SAMPLES BEFORE WASHING BY SOLVENTS.
- v.- DO NOT APPLY LOCKING SPRAY OR PAINT TO TRIMMER. ELECTRIC SPECIFICATIONS MAY BE AFFECTED ADVERSELY.
- vi.- PRODUCT CONTAINS LUBRICATION OIL. LUBRICATION LEAKS WILL NOT AFFECT PRODUCT SOLDERABILITY.
- vii.- USE OF CERAMIC SCREWDRIVERS IS RECOMMENDED FOR TUNING.
- viii.- DO NOT APPLY AXIAL LOAD DURING TUNING IN EXCESS OF  $0.3[\text{lb}f]/1.5[\text{N}]$ .
- ix.- KEEP PARTS OUT OF DIRECT SUNLIGHT EXPOSURE. STORE PARTS IN DUST-FREE ENVIRONMENT.

## SOLDERING RECOMMENDATIONS

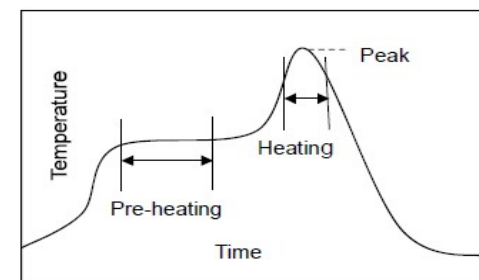



## STANDARD LEAD-FREE SOLDERING PROFILE

STAGE	SAC305 SOLDER	EUTECTIC SOLDER
	PRE-HEATING	TEMPERATURE: 150[°C] - 180[°C] TIME: 60 - 120 SECONDS
HEATING	TEMPERATURE: 220[°C] MIN. TIME: 30 - 60 SECONDS	TEMPERATURE: 183[°C] MIN. TIME: 30 - 60 SECONDS
PEAK HEAT	TEMPERATURE: 265[°C] TIME: 3 SECONDS MAX	TEMPERATURE: 265[°C] TIME: 3 SECONDS MAX
REFLOW CYCLES	2 TIMES MAX	2 TIMES MAX
SOLDERING IRON		
SPEC	TEMPERATURE 400[°C] MAX TIME: 3 SECONDS MAX	

		VOLTRONICS		
		THE TRIMMER CAPACITOR COMPANY 2250 NORTHWOOD DRIVE SALISBURY, MARYLAND 21801		
DL1 • Novacap • Syfer • Voltronics	SIZE	CAGE CODE	PART NUMBER	REV
	C	55153	JZxxx	G
SCALE	PER VIEW	DWG NO.	V-7531	SHEET 2 OF 2

## Looking for pricing, stock, or lifecycle information?

Click below to explore more details on WIN SOURCE:

-  [View JZ030 on WIN SOURCE](#)
-  [Knowles Voltronics Information](#)

## Optimize Your Supply Chain with WIN SOURCE Solutions

-  Global Sourcing Solution
-  Obsolete Management
-  Cost Control Management
-  Shortage Management
-  Alternative Solution
-  Excess Inventory Management