



**THE DATASHEET OF
DE2E3SA222MN3AX02F**



Reference Specification

Safety Standard Certified Lead Type Disc Ceramic Capacitors for
Consumer Electronics & Industrial Equipment /Type SA

Product specifications in this catalog are as of May. 2024, and are subject to change or obsolescence without notice.
Please consult the approval sheet before ordering. Please read rating and Cautions first.

<Reference> Please kindly use our website.

Please refer to the product information page for more information on ceramic capacitors. → [Ceramic capacitor product information](#)

Various data can be obtained directly from the product search. → [Product search \(SMD\)](#) / [Product search \(Lead Type\)](#)

⚠ CAUTION**1. OPERATING VOLTAGE**

Do not apply a voltage to a safety standard certified product that exceeds the rated voltage as called out in the specifications. Applied voltage between the terminals of a safety standard certified product shall be less than or equal to the rated voltage (+10 %). When a safety standard certified product is used as a DC voltage product, the AC rated voltage value becomes the DC rated voltage value.

(Example: AC250 V (r.m.s.) rated product can be used as DC250 V (+10 %) rated product.)

If both AC rated voltage and DC rated voltage are specified, apply the voltage lower than the respective rated voltage.

1-1. When a safety standard certified product is used in a circuit connected to a commercial power supply, ensure that the applied commercial power supply voltage including fluctuation should be less than 10 % above its rated voltage.

1-2. When using a safety standard certified product as a DC rated product in circuits other than those connected to a commercial power supply.

When AC voltage is superimposed on DC voltage, the zero-to-peak voltage shall not exceed the rated DC voltage. When AC voltage or pulse voltage is applied, the peak-to-peak voltage shall not exceed the rated DC voltage.

Typical Voltage Applied to the DC Capacitor

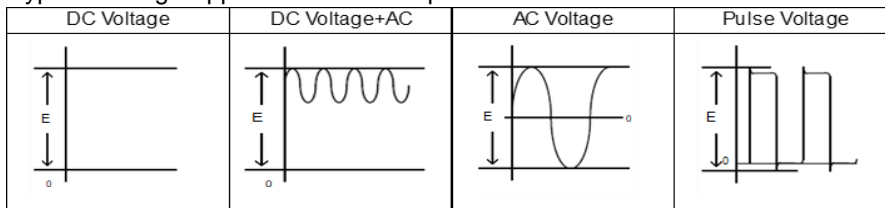

(E: Maximum possible applied voltage.)

1-3. Influence of over voltage

Over voltage that is applied to the capacitor may result in an electrical short circuit caused by the breakdown of the internal dielectric layers. The time duration until breakdown depends on the applied voltage and the ambient temperature.

2. OPERATING TEMPERATURE AND SELF-GENERATED HEAT

Keep the surface temperature of a capacitor below the upper limit of its rated operating temperature range. Be sure to take into account the heat generated by the capacitor itself.

When the capacitor is used in a high-frequency current, pulse current or the like, it may have the self-generated heat due to dielectric-loss.

In case of Class 2 capacitors (Temp.Char.: B,E,F, etc.), applied voltage should be the load such as self-generated heat is within 20 °C on the condition of atmosphere temperature 25 °C.

Since the self-heating is low in the Class 1 capacitors (Temp.Char.: SL etc.), the allowable power becomes extremely high compared to the Class 2 capacitors.

However, when a load with self-heating of 20 °C is applied at the rated voltage, the allowable power may be exceeded. Please confirm that there is no rising trend of the capacitor's surface temperature and that the surface temperature of the capacitor does not exceed the maximum operating temperature.

Excessive generation of heat may cause deterioration of the characteristics and reliability of the capacitor.

When measuring the self-heating temperature, be aware that accurate measurement may not be possible due to the following effects.

- The heat generated by other parts
- Air flow such as convection and cooling fans
- Temperature sensor used for measuring surface temperature of capacitor

In the case using a thermocouple, it is recommended that use a K thermocouple of $\Phi 0.1$ mm with less heat capacity.

3. TEST CONDITION FOR WITHSTANDING VOLTAGE

3-1. TEST EQUIPMENT

Test equipment for AC withstanding voltage should be used with the performance of the wave similar to 50/60 Hz sine wave.

If the distorted sine wave or over load exceeding the specified voltage value is applied, the defective may be caused.

3-2. VOLTAGE APPLIED METHOD

When the withstanding voltage is applied, capacitor's lead or terminal should be firmly connected to the out-put of the withstanding voltage test equipment, and then the voltage should be raised from near zero to the test voltage.

If the test voltage without the raise from near zero voltage would be applied directly to capacitor, test voltage should be applied with the *zero cross. At the end of the test time, the test voltage should be reduced to near zero, and then capacitor's lead or terminal should be taken off the out-put of the withstanding voltage test equipment.

If the test voltage without the raise from near zero voltage would be applied directly to capacitor, the surge voltage may arise, and therefore, the defective may be caused.

*ZERO CROSS is the point where voltage sine wave pass 0 V.

- See the right figure -

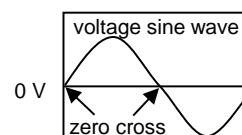

4. FAIL-SAFE

Capacitors that are cracked by dropping or bending of the board may cause deterioration of the insulation resistance, and result in a short.

If the circuit being used may cause an electrical shock, smoke or fire when a capacitor is shorted, be sure to install fail-safe functions, such as a fuse, to prevent secondary accidents.

5. OPERATING AND STORAGE ENVIRONMENT

The insulating coating of capacitors does not form a perfect seal; therefore, do not use or store capacitors in a corrosive atmosphere, especially where chloride gas, sulfide gas, acid, alkali, salt or the like are present. And avoid exposure to moisture. Before cleaning, bonding, or molding this product, verify that these processes do not affect product quality by testing the performance of a cleaned, bonded or molded product in the intended equipment. Store the capacitors where the temperature and relative humidity do not exceed -10 to 40 °C and 15 to 85 %.

Use capacitors within 6 months after delivered. Check the solderability after 6 months or more.

6. VIBRATION AND IMPACT

Do not expose a capacitor or its leads to excessive shock or vibration during use.

- 6-1. Mechanical shock due to being dropped may cause damage or a crack in the dielectric material of the capacitor.

Do not use a dropped capacitor because the quality and reliability may be deteriorated.

- 6-2. Excessive shock or vibration may cause to fatigue destruction of lead wires mounted on the circuit board.

If necessary, take measures to hold a capacitor on the circuit boards by adhesive, molding resin or coating and other.

Please confirm there is no influence of holding measures on the product with an intended equipment.

7. SOLDERING

When soldering this product to a PCB/PWB, do not exceed the solder heat resistance specification of the capacitor. Subjecting this product to excessive heating could melt the internal junction solder and may result in thermal shocks that can crack the ceramic element.

Please verify that the soldering process does not affect the quality of capacitors.

7-1. Flow Soldering

Soldering temperature : 260 °C max.

Soldering time : 7.5 s max.

Preheating temperature : 120 °C max.

Preheating time : 60 s max.

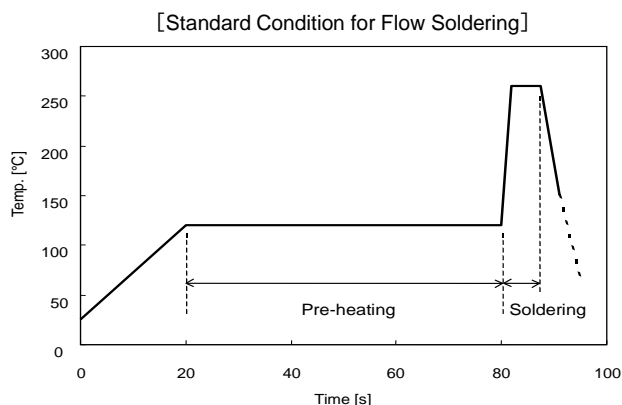

7-2. Reflow Soldering

Do not apply reflow soldering.

7-3. Soldering Iron

Temperature of iron-tip : 400 °C max.

Soldering iron wattage : 50 W max.

Soldering time : 3.5 s max.

8. BONDING, RESIN MOLDING AND COATING

Before bonding, molding or coating this product, verify that these processes do not affect the quality of capacitor by testing the performance of the bonded, molded or coated product in the intended equipment.

In case of the amount of applications, dryness / hardening conditions of adhesives and molding resins containing organic solvents (ethyl acetate, methyl ethyl ketone, toluene, etc.) are unsuitable, the outer coating resin of a capacitor is damaged by the organic solvents and it may result, worst case, in a short circuit.

The variation in thickness of adhesive, molding resin or coating may cause a outer coating resin cracking and/or ceramic element cracking of a capacitor in a temperature cycling.

9. TREATMENT AFTER BONDING, RESIN MOLDING AND COATING

When the outer coating is hot (over 100 °C) after soldering, it becomes soft and fragile.

So please be careful not to give it mechanical stress.

Failure to follow the above cautions may result, worst case, in a short circuit and cause fuming or partial dispersion when the product is used.

10. LIMITATION OF APPLICATIONS

The products listed in the specification (hereinafter the product(s) is called as the "Product(s)") are designed and manufactured for applications specified in the specification. (hereinafter called as the "Specific Application")

We shall not warrant anything in connection with the Products including fitness, performance, adequateness, safety, or quality, in the case of applications listed in from (1) to (11) written at the end of this precautions, which may generally require high performance, function, quality, management of production or safety.

Therefore, the Product shall be applied in compliance with the specific application.

WE DISCLAIM ANY LOSS AND DAMAGES ARISING FROM OR IN CONNECTION WITH THE PRODUCTS INCLUDING BUT NOT LIMITED TO THE CASE SUCH LOSS AND DAMAGES CAUSED BY THE UNEXPECTED ACCIDENT, IN EVENT THAT (i) THE PRODUCT IS APPLIED FOR THE PURPOSE WHICH IS NOT SPECIFIED AS THE SPECIFIC APPLICATION FOR THE PRODUCT, AND/OR (ii) THE PRODUCT IS APPLIED FOR ANY FOLLOWING APPLICATION PURPOSES FROM (1) TO (11) (EXCEPT THAT SUCH APPLICATION PURPOSE IS UNAMBIGUOUSLY SPECIFIED AS SPECIFIC APPLICATION FOR THE PRODUCT IN OUR CATALOG SPECIFICATION FORMS, DATASHEETS, OR OTHER DOCUMENTS OFFICIALLY ISSUED BY US*)

1. Aircraft equipment
2. Aerospace equipment
3. Undersea equipment
4. Power plant control equipment
5. Medical equipment
6. Transportation equipment
7. Traffic control equipment
8. Disaster prevention/security equipment
9. Industrial data-processing equipment
10. Combustion/explosion control equipment
11. Equipment with complexity and/or required reliability equivalent to the applications listed in the above.

For exploring information of the Products which will be compatible with the particular purpose other than those specified in the specification, please contact our sales offices, distribution agents, or trading companies with which you make a deal, or via our web contact form.

Contact form: <https://www.murata.com/contactform>

*We may design and manufacture particular Products for applications listed in (1) to (11). Provided that, in such case we shall unambiguously specify such Specific Application in the specification without any exception.

Therefore, any other documents and/or performances, whether exist or non-exist, shall not be deemed as the evidence to imply that we accept the applications listed in (1) to (11).

NOTICE**1. CLEANING (ULTRASONIC CLEANING)**

- 1-1. Please evaluate the capacitor using actual cleaning equipment and conditions to confirm the quality, and select the solvent for cleaning.
- 1-2. Unsuitable cleaning may leave residual flux or other foreign substances, causing deterioration of electrical characteristics and the reliability of the capacitors.
- 1-3. To perform ultrasonic cleaning, observe the following conditions.
 - Rinse bath capacity : Output of 20 watts per liter or less.
 - Rinsing time : 5 min maximum.
 - Do not vibrate the PCB/PWB directly.
 - Excessive ultrasonic cleaning may lead to fatigue destruction of the terminals.

2. SOLDERING AND MOUNTING

2-1. Insert the lead wire into the PCB with a distance appropriate to the lead space.

If the lead wires are inserted into different spacing holes, cracks may occur in the outer resin or the internal element.

2-2. When bending the lead wire, excessive force applied to the capacitor body may cause cracks in the outer resin or the internal element. Hold the lead wire closer to the capacitor body than the lead wire bending position with the fixture, then bend it.

(See the right figure)

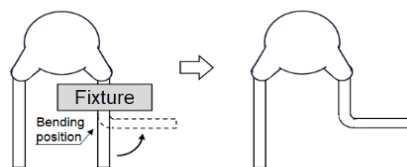

2-3. When cutting and clinching the lead wire, do not apply excessive force to the capacitor body.

2-4. When soldering, insert the lead wire into the PCB without mechanically stressing the lead wire.

3. CAPACITANCE CHANGE OF CAPACITORS

- Class 1 capacitors

Capacitance might change a little depending on a surrounding temperature or an applied voltage.

Please contact us if you use for the strict time constant circuit.

- Class 2 capacitors

Class 2 capacitors like temperature characteristic B, E and F have an aging characteristic, whereby the capacitor continually decreases its capacitance slightly if the capacitor leaves for a long time. Moreover, capacitance might change greatly depending on a surrounding temperature or an applied voltage. So, it is not likely to be able to use for the time constant circuit.

Please contact us if you need a detail information.

4. CHARACTERISTICS EVALUATION IN THE ACTUAL SYSTEM

4-1. Evaluate the capacitor in the actual system, to confirm that there is no problem with the performance and specification values in a finished product before using.

4-2. Since a voltage dependency and temperature dependency exists in the capacitance of Class 2 ceramic capacitors, the capacitance may change depending on the operating conditions in the actual system. Therefore, be sure to evaluate the various characteristics, such as the leakage current and noise absorptivity, which will affect the capacitance value of the capacitor.

4-3. In addition, voltages exceeding the predetermined surge may be applied to the capacitor by the inductance in the actual system.

Evaluate the surge resistance in the actual system as required.

4-4. When using Class 2 ceramic capacitors in AC or pulse circuits, the capacitor itself vibrates at specific frequencies and noise may be generated. Moreover, when the mechanical vibration or shock is added to capacitor, noise may occur.

⚠ NOTE

1. Please make sure that your product has been evaluated in view of your specifications with our product being mounted to your product.
2. You are requested not to use our product deviating from this specification.

1.Application

This product specification is applied to Safety Standard Certified Lead Type Disc Ceramic Capacitors Type SA.

The safety standard certification is obtained as Class X1, Y2.

1. Specific applications:

- Consumer Equipment: Products that can be used in consumer equipment such as home appliances, audio/visual equipment, communication equipment, information equipment, office equipment, and household robotics, and whose functions are not directly related to the protection of human life and property.
- Industrial Equipment: Products that can be used in industrial equipment such as base stations, manufacturing equipment, industrial robotics equipment, and measurement equipment, and whose functions do not directly relate to the protection of human life and property.
- Medial Equipment [GHTF A/B/C] except for Implant Equipment: Products suitable for use in medical devices designated under the GHTF international classifications as Class A or Class B (the functions of which are not directly involved in protection of human life or property) or in medical devices other than implants designated under the GHTF international classifications as Class C (the malfunctioning of which is considered to pose a comparatively high risk to the human body).
- Automotive infotainment/comfort equipment: Products that can be used for automotive equipment such as car navigation systems and car audio systems that do not directly relate to human life and whose structure, equipment, and performance are not specifically required by law to meet technical standards for safety assurance or environmental protection.

2. Unsuitable Application: Applications listed in "Limitation of applications" in this product specification.

Approval standard and certified number

	Standard number	*Certified number	Rated voltage
ENEC (VDE)	EN60384-14	40042990	X1: AC300 V(r.m.s.) / DC1,500 V Y2: AC300 V(r.m.s.) / DC1,500 V
UL/cUL	UL60384-14/CSA E60384-14	E37921	X1: AC300 V(r.m.s.)
CQC	IEC60384-14	CQC15001137840	Y2: AC300 V(r.m.s.)

*Above Certified number may be changed on account of the revision of standards and the renewal of certification.

2. Rating

2-1. Operating temperature range

-40 ~ 125°C

2-2. Rated Voltage

X1: AC300 V(r.m.s.)
Y2: AC300 V(r.m.s.)
DC1,500 V

2-3. Part number configuration

ex.)

<u>DE2</u>	<u>F3</u>	<u>SA</u>	<u>103</u>	<u>M</u>	<u>A3</u>	<u>B</u>	<u>X02F</u>
Series	Temperature Characteristics	Certified Type	Capacitance	Capacitance Tolerance	Lead Style	Package	Individual Specification

• Series

DE2 denotes class X1, Y2.

Reference only

3. Marking

- Certified type : SA
Capacitance : Actual value(under 100 pF)
3 digit system(100 pF and over)
Capacitance tolerance : Code
Class code and Rated voltage mark : **X1 300~**
Y2 300~
Manufacturing year : Letter code(The last digit of A.D. year.)
Manufacturing month : Code
(Feb./Mar. → 2 Aug./Sep. → 8)
(Apr./May → 4 Oct./Nov. → O)
(Jun./Jul. → 6 Dec./Jan. → D)
Company name code : **CM15** (Made in Thailand)

(Example)

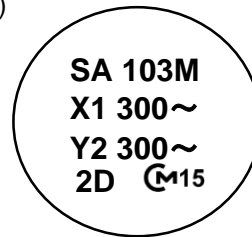

4. Part number list

Vertical crimp long type
(Lead Style: A*)

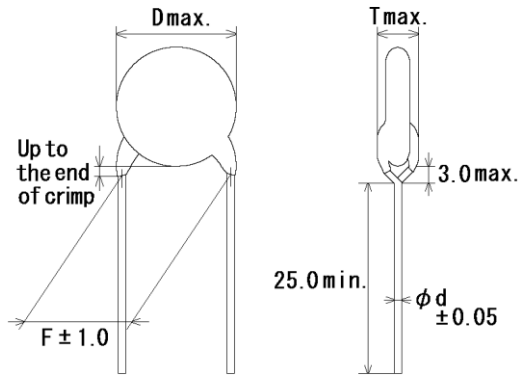

Note) The mark '*' of Lead Style differ from lead spacing (F) and lead diameter (d).
Please see the following list about details.

Unit : mm

Customer Part Number	Murata Part Number	T.C.	Cap. (pF)	Cap. tol.	Dimension (mm)				Lead Style	Pack qty. (pcs)
					D	T	F	d		
	DE21XSA100KA3BX02F	SL	10	±10%	7.0	4.0	7.5	0.6	A3	250
	DE21XSA150KA3BX02F	SL	15	±10%	6.0	5.0	7.5	0.6	A3	500
	DE21XSA220KA3BX02F	SL	22	±10%	6.0	4.0	7.5	0.6	A3	500
	DE21XSA330KA3BX02F	SL	33	±10%	7.0	4.0	7.5	0.6	A3	250
	DE21XSA470KA3BX02F	SL	47	±10%	7.0	4.0	7.5	0.6	A3	250
	DE21XSA680KA3BX02F	SL	68	±10%	8.0	4.0	7.5	0.6	A3	250
	DE2B3SA101KA3BX02F	B	100	±10%	6.0	4.0	7.5	0.6	A3	500
	DE2B3SA151KA3BX02F	B	150	±10%	6.0	4.0	7.5	0.6	A3	500
	DE2B3SA221KA3BX02F	B	220	±10%	6.0	5.0	7.5	0.6	A3	500
	DE2B3SA331KA3BX02F	B	330	±10%	6.0	4.0	7.5	0.6	A3	500
	DE2B3SA471KA3BX02F	B	470	±10%	7.0	4.0	7.5	0.6	A3	250
	DE2B3SA681KA3BX02F	B	680	±10%	7.0	4.0	7.5	0.6	A3	250
	DE2E3SA102MA3BX02F	E	1000	±20%	6.0	4.0	7.5	0.6	A3	500
	DE2E3SA152MA3BX02F	E	1500	±20%	7.0	4.0	7.5	0.6	A3	250
	DE2E3SA222MA3BX02F	E	2200	±20%	8.0	4.0	7.5	0.6	A3	250
	DE2E3SA332MA3BX02F	E	3300	±20%	9.0	4.0	7.5	0.6	A3	250
	DE2E3SA472MA3BX02F	E	4700	±20%	10.0	5.0	7.5	0.6	A3	250
	DE2F3SA103MA3BX02F	F	10000	±20%	14.0	5.0	7.5	0.6	A3	200

Reference only

-Vertical crimp short type
(Lead Style: J*)

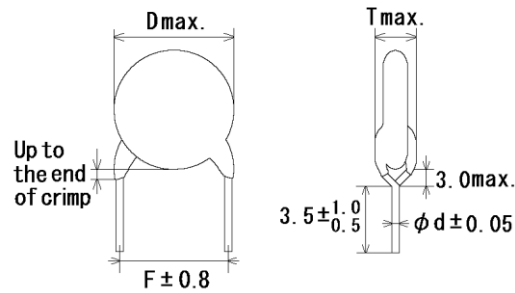

Note) The mark ' * ' of Lead Style differ from lead spacing (F) and lead diameter (d).
Please see the following list about details.

Unit : mm

Customer Part Number	Murata Part Number	T.C.	Cap. (pF)	Cap. tol.	Dimension (mm)				Lead Style	Pack qty. (pcs)
					D	T	F	d		
	DE21XSA100KJ3BX02F	SL	10	±10%	7.0	4.0	7.5	0.6	J3	500
	DE21XSA150KJ3BX02F	SL	15	±10%	6.0	5.0	7.5	0.6	J3	500
	DE21XSA220KJ3BX02F	SL	22	±10%	6.0	4.0	7.5	0.6	J3	500
	DE21XSA330KJ3BX02F	SL	33	±10%	7.0	4.0	7.5	0.6	J3	500
	DE21XSA470KJ3BX02F	SL	47	±10%	7.0	4.0	7.5	0.6	J3	500
	DE21XSA680KJ3BX02F	SL	68	±10%	8.0	4.0	7.5	0.6	J3	500
	DE2B3SA101KJ3BX02F	B	100	±10%	6.0	4.0	7.5	0.6	J3	500
	DE2B3SA151KJ3BX02F	B	150	±10%	6.0	4.0	7.5	0.6	J3	500
	DE2B3SA221KJ3BX02F	B	220	±10%	6.0	5.0	7.5	0.6	J3	500
	DE2B3SA331KJ3BX02F	B	330	±10%	6.0	4.0	7.5	0.6	J3	500
	DE2B3SA471KJ3BX02F	B	470	±10%	7.0	4.0	7.5	0.6	J3	500
	DE2B3SA681KJ3BX02F	B	680	±10%	7.0	4.0	7.5	0.6	J3	500
	DE2E3SA102MJ3BX02F	E	1000	±20%	6.0	4.0	7.5	0.6	J3	500
	DE2E3SA152MJ3BX02F	E	1500	±20%	7.0	4.0	7.5	0.6	J3	500
	DE2E3SA222MJ3BX02F	E	2200	±20%	8.0	4.0	7.5	0.6	J3	500
	DE2E3SA332MJ3BX02F	E	3300	±20%	9.0	4.0	7.5	0.6	J3	500
	DE2E3SA472MJ3BX02F	E	4700	±20%	10.0	5.0	7.5	0.6	J3	500
	DE2F3SA103MJ3BX02F	F	10000	±20%	14.0	5.0	7.5	0.6	J3	250

Reference only

·Vertical crimp tapping type
(Lead Style:N*)

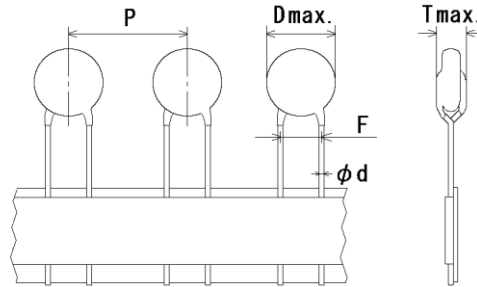

Note) The mark ' * ' of Lead Style differ from lead spacing (F) ,
lead diameter (d) and pitch of component (P).
Please see the following list or taping specification about details.

Unit : mm

Customer Part Number	Murata Part Number	T.C.	Cap. (pF)	Cap. tol.	Dimension (mm)					Lead Style	Pack qty. (pcs)
					D	T	F	d	P		
	DE21XSA100KN3AX02F	SL	10	±10%	7.0	4.0	7.5	0.6	15.0	N3	1000
	DE21XSA150KN3AX02F	SL	15	±10%	6.0	5.0	7.5	0.6	15.0	N3	1000
	DE21XSA220KN3AX02F	SL	22	±10%	6.0	4.0	7.5	0.6	15.0	N3	1000
	DE21XSA330KN3AX02F	SL	33	±10%	7.0	4.0	7.5	0.6	15.0	N3	1000
	DE21XSA470KN3AX02F	SL	47	±10%	7.0	4.0	7.5	0.6	15.0	N3	1000
	DE21XSA680KN3AX02F	SL	68	±10%	8.0	4.0	7.5	0.6	15.0	N3	1000
	DE2B3SA101KN3AX02F	B	100	±10%	6.0	4.0	7.5	0.6	15.0	N3	1000
	DE2B3SA151KN3AX02F	B	150	±10%	6.0	4.0	7.5	0.6	15.0	N3	1000
	DE2B3SA221KN3AX02F	B	220	±10%	6.0	5.0	7.5	0.6	15.0	N3	1000
	DE2B3SA331KN3AX02F	B	330	±10%	6.0	4.0	7.5	0.6	15.0	N3	1000
	DE2B3SA471KN3AX02F	B	470	±10%	7.0	4.0	7.5	0.6	15.0	N3	1000
	DE2B3SA681KN3AX02F	B	680	±10%	7.0	4.0	7.5	0.6	15.0	N3	1000
	DE2E3SA102MN3AX02F	E	1000	±20%	6.0	4.0	7.5	0.6	15.0	N3	1000
	DE2E3SA152MN3AX02F	E	1500	±20%	7.0	4.0	7.5	0.6	15.0	N3	1000
	DE2E3SA222MN3AX02F	E	2200	±20%	8.0	4.0	7.5	0.6	15.0	N3	1000
	DE2E3SA332MN3AX02F	E	3300	±20%	9.0	4.0	7.5	0.6	15.0	N3	1000
	DE2E3SA472MN3AX02F	E	4700	±20%	10.0	5.0	7.5	0.6	15.0	N3	1000
	DE2F3SA103MN3AX02F	F	10000	±20%	14.0	5.0	7.5	0.6	15.0	N3	900

Reference only

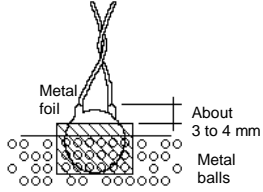
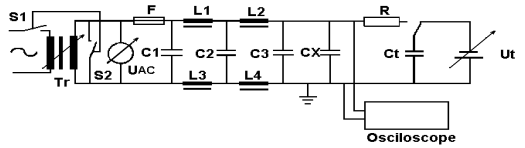
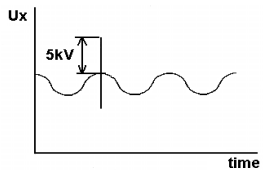
5. Specification												
No.	Test Item		Specification	Test Method (Ref. Standard:JIS C 5101(all parts), IEC60384(all parts))								
1	Appearance and dimensions		No marked defect on appearance form and dimensions. Please refer to [Part number list].	The capacitor should be inspected by naked eyes for visible evidence of defect. Dimensions should be measured with slide calipers.								
2	Marking		To be easily legible.	The capacitor should be inspected by naked eyes.								
3	Dielectric strength	Between lead wires	No failure.	The capacitor should not be damaged when AC2,600 V(r.m.s.) <50/60 Hz> and DC3,225 V is applied between the lead wires for 60 s. First, the terminals of the capacitor should be connected together. Then, a metal foil should be closely wrapped around the body of the capacitor to the distance of about 3 to 4 mm from each terminal. Then, the capacitor should be inserted into a container filled with metal balls of about 1 mm diameter. Finally, AC2,600 V(r.m.s.) <50/60 Hz> and DC3,225 V is applied for 60 s between the capacitor lead wires and metal balls.								
		Terminal To External Resin	No failure.									
												
4	Insulation Resistance (I.R.)		10,000 MΩ min.	The insulation resistance should be measured with DC500±50 V within 60±5 s of charging. The voltage should be applied to the capacitor through a resistor of 1 MΩ.								
5	Capacitance		Within specified tolerance.	The capacitance should be measured at 20 °C with 1±0.1 kHz and AC1±0.2 V(r.m.s.) max..								
6	Dissipation Factor (D.F.)		Char. B, E : DF ≤ 0.025 Char. F : DF ≤ 0.05	The dissipation factor should be measured at 20 °C with 1±0.1 kHz and AC1±0.2 V(r.m.s.) max..								
7	Temperature characteristic		Char. SL : +350 to -1,000 ppm/ °C (Temp. range : 20 to 85 °C) Char. B : Within ±10 % Char. E : Within +20/-55 % Char. F : Within +30/-80 % (Temp. range : -25 to 85 °C)	The capacitance measurement should be made at each step specified in Table.								
					<table border="1" data-bbox="782 1176 1444 1243"> <thead> <tr> <th>Step</th> <th>1</th> <th>2</th> <th>3</th> <th>4</th> <th>5</th> </tr> </thead> <tbody> <tr> <td>Temp.(°C)</td> <td>20±2</td> <td>-25±2</td> <td>20±2</td> <td>85±2</td> <td>20±2</td> </tr> </tbody> </table>	Step	1	2	3	4	5	Temp.(°C)
Step	1	2	3	4	5							
Temp.(°C)	20±2	-25±2	20±2	85±2	20±2							
8	Active flammability		The cheese-cloth should not be on fire.	<p>The capacitors should be individually wrapped in at least one but more than two complete layers of cheese-cloth. The capacitor should be subjected to 20 discharges. The interval between successive discharges should be 5 s. The UAc should be maintained for 2 min after the last discharge.</p>  <p> C1,2 : 1 μF±10 %, C3 : 0.033 μF±5 % 10 kV L1 to L4 : 1.5 mH±20 % 16 A Rod core choke R : 100 Ω±2 %, Ct : 3 μF±5 % 10 kV UAc : UR ±5 % UR : Rated working voltage Cx : Capacitor under test F : Fuse, Rated 10 A Ut : Voltage applied to Ct </p> 								

Reference only

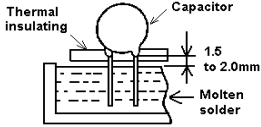
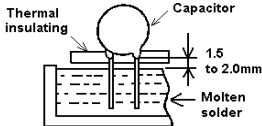
No.	Test Item	Specification	Test Method (Ref. Standard:JIS C 5101(all parts), IEC60384(all parts))		
9	Robustness of terminations	Tensile	Lead wire should not cut off. Capacitor should not be broken.	Fix the body of capacitor, apply a tensile weight gradually to each lead wire in the radial direction of capacitor up to 10 N and keep it for 10±1 s. With the termination in its normal position, the capacitor is held by its body in such a manner that the axis of the termination is vertical; a mass applying a force of 5 N is then suspended from the end of the termination. The body of the capacitor is then inclined, within a period of 2 to 3 s, through an angle of about 90 ° in the vertical plane and then returned to its initial position over the same period of time; this operation constitutes one bend. One bend immediately followed by a second bend in the opposite direction.	
		Bending			
10	Vibration resistance	Appearance	No marked defect.	The capacitor should be firmly soldered to the supporting lead wire and vibration which is 10 to 55 Hz in the vibration frequency range, 1.5 mm in total amplitude, and about 1 min in the rate of vibration change from 10 Hz to 55 Hz and back to 10 Hz is applied for a total of 6 h; 2 h each in 3 mutually perpendicular directions.	
		Capacitance			Within the specified tolerance.
		Dissipation Factor (D.F.)			Char. B, E : $DF \leq 0.025$ Char. F : $DF \leq 0.05$
11	Solderability of leads	Lead wire should be soldered with uniformly coated on the axial direction over 3/4 of the circumferential direction.	The lead wire of a capacitor should be dipped into a rosin ethanol (25 % rosin in weight proportion). Immerse in solder solution for 2±0.5 s. In both cases the depth of dipping is up to about 1.5 to 2.0 mm from the root of lead wires. Temp. of solder : 245±5 °C		
12	Soldering effect (Non-preheat)	Appearance	No marked defect.	Solder temperature : 350±10 °C or 260±5 °C Immersion time : 3.5±0.5 s (In case of 260±5 °C : 10±1 s) The depth of immersion is up to about 1.5 to 2.0 mm from the root of lead wires. 	
		Capacitance change			Within ±10 %
		I.R.			1,000 MΩ min.
		Dielectric strength			Per item 3
13	Soldering effect (On-preheat)	Appearance	No marked defect.	First the capacitor should be stored at 120+0/-5 °C for 60+0/-5 s. Then, as in figure, the lead wires should be immersed solder of 260+0/-5 °C up to 1.5 to 2.0 mm from the root of terminal for 7.5+0/-1 s. 	
		Capacitance change			Within ±10 %
		I.R.			1,000 MΩ min.
		Dielectric strength			Per item 3

* "room condition" Temperature : 15 to 35 °C, Relative humidity : 45 to 75 %, Atmospheric pressure : 86 to 106 kPa

Reference only

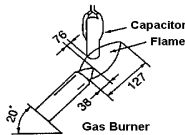
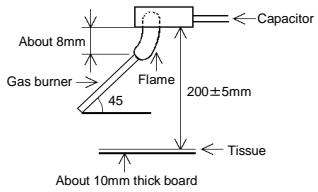
No.	Test Item	Specification	Test Method (Ref. Standard:JIS C 5101(all parts), IEC60384(all parts))						
14	Flame test	The capacitor flame discontinue as follows. <table border="1" style="margin-left: auto; margin-right: auto;"> <thead> <tr> <th>Cycle</th> <th>Time</th> </tr> </thead> <tbody> <tr> <td>1 to 4</td> <td>30 s max.</td> </tr> <tr> <td>5</td> <td>60 s max.</td> </tr> </tbody> </table>	Cycle	Time	1 to 4	30 s max.	5	60 s max.	The capacitor should be subjected to applied flame for 15 s. and then removed for 15 s until 5 cycles.  (in mm)
Cycle	Time								
1 to 4	30 s max.								
5	60 s max.								
15	Passive flammability	The burning time should not be exceeded the time 30 s. The tissue paper should not ignite.	The capacitor under test should be held in the flame in the position which best promotes burning. Time of exposure to flame is for 30 s. Length of flame : 12±1 mm Gas burner : Length 35 mm min. : Inside Dia. 0.5±0.1 mm : Outside Dia. 0.9 mm max. Gas : Butane gas Purity 95 % min. 						
16	Humidity (Under steady state)	Appearance	No marked defect.	Set the capacitor for 500±12 h at 40±2 °C in 90 to 95 % relative humidity. Pre-treatment : Capacitor should be stored at 125±2 °C for 1 h, and apply the AC2,000 V(r.m.s.) 60 s then placed at *room condition for 24±2 h before initial measurements. (Do not apply to Char. SL) Post-treatment : Capacitor should be stored for 1 to 2 h at *room condition.					
		Capacitance change	Char. SL : Within ±5 % Char. B : Within ±10 % Char. E, F : Within ±15 %						
		Dissipation Factor (D.F.)	Char. SL : DF≤0.025 Char. B, E : DF≤0.05 Char. F : DF≤0.075						
		I.R.	3,000 MΩ min.						
		Dielectric strength	Per item 3						
17-1	Humidity loading (AC)	Appearance	No marked defect.	Apply AC300 V(r.m.s.) for 500±12 h at 40±2 °C in 90 to 95 % relative humidity. Pre-treatment : Capacitor should be stored at 125±2 °C for 1 h, and apply the AC2,000 V(r.m.s.) 60 s then placed at *room condition for 24±2 h before initial measurements. (Do not apply to Char. SL) Post-treatment : Capacitor should be stored for 1 to 2 h at *room condition.					
		Capacitance change	Char. SL : Within ±5 % Char. B : Within ±10 % Char. E, F : Within ±15 %						
		Dissipation Factor (D.F.)	Char. SL : DF≤0.025 Char. B, E : DF≤0.05 Char. F : DF≤0.075						
		I.R.	3,000 MΩ min.						
		Dielectric strength	Per item 3						
17-2	Humidity loading (DC)	Appearance	No marked defect.	Apply DC1,500 V for 500±12 h at 40±2 °C in 90 to 95 % relative humidity. Pre-treatment : Capacitor should be stored at 125±2 °C for 1 h, and apply the AC2,000 V(r.m.s.) 60 s then placed at *room condition for 24±2 h before initial measurements. (Do not apply to Char. SL) Post-treatment : Capacitor should be stored for 1 to 2 h at *room condition.					
		Capacitance change	Char. SL : Within ±5 % Char. B : Within ±10 % Char. E, F : Within ±15 %						
		Dissipation Factor (D.F.)	Char. SL : DF≤0.025 Char. B, E : DF≤0.05 Char. F : DF≤0.075						
		I.R.	3,000 MΩ min.						
		Dielectric strength	Per item 3						

* "room condition" Temperature : 15 to 35 °C, Relative humidity : 45 to 75 %, Atmospheric pressure : 86 to 106 kPa

Reference only

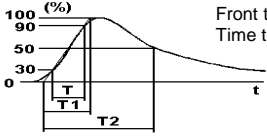
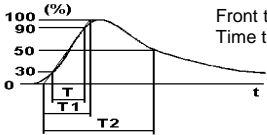
No.	Test Item	Specification	Test Method (Ref. Standard:JIS C 5101(all parts), IEC60384(all parts))														
18-1	Life (AC)	Appearance	No marked defect.														
	Capacitance change	Within $\pm 20\%$	Impulse voltage Each individual capacitor should be subjected to a 5 kV impulses for three times or more. Then the capacitors are applied to life test.  <p>Front time (T1) = 1.7 μs=1.67T Time to half-value (T2) = 50 μs</p>														
	I.R.	3,000 M Ω min.															
	Dielectric strength	Per item 3															
The capacitors are placed in a circulating air oven for a period of 1,000 h. The air in the oven is maintained at a temperature of 125+2/-0 °C, and relative humidity of 50 % max.. Throughout the test, the capacitors are subjected to a AC510 V(r.m.s.) <50/60 Hz> alternating voltage of mains frequency, except that once each hour the voltage is increased to AC1,000 V(r.m.s.) for 0.1 s. Pre-treatment : Capacitor should be stored at 125 \pm 2 °C for 1 h, and apply the AC2,000 V(r.m.s.) 60 s then placed at *room condition for 24 \pm 2 h before initial measurements. (Do not apply to Char. SL) Post-treatment : Capacitor should be stored for 24 \pm 2 h at *room condition.																	
18-2	Life (DC)	Appearance	No marked defect.														
	Capacitance change	Within $\pm 20\%$	Impulse voltage Each individual capacitor should be subjected to a 5 kV impulses for three times or more. Then the capacitors are applied to life test.  <p>Front time (T1) = 1.7 μs=1.67T Time to half-value (T2) = 50 μs</p>														
	I.R.	3,000 M Ω min.															
	Dielectric strength	Per item 3															
Apply DC2,550 V for 1,000 h at 125+2/-0 °C, relative humidity 50 % max. Pre-treatment : Capacitor should be stored at 125 \pm 2 °C for 1 h, and apply the AC2,000 V(r.m.s.) 60 s then placed at *room condition for 24 \pm 2 h before initial measurements. (Do not apply to Char. SL) Post-treatment : Capacitor should be stored for 24 \pm 2 h at *room condition.																	
19	Temperature Cycle	Appearance	No marked defect.														
		Capacitance change	Char. SL : Within $\pm 5\%$ Char. B : Within $\pm 10\%$ Char. E, F : Within $\pm 20\%$														
		Dissipation Factor (D.F.)	Char. SL : DF \leq 0.025 Char. B, E : DF \leq 0.05 Char. F : DF \leq 0.075														
		I.R.	3,000 M Ω min.														
		Dielectric strength	Per item 3														
<table border="1" data-bbox="874 1482 1279 1644"> <thead> <tr> <th>Step</th> <th>Temperature(°C)</th> <th>Time</th> </tr> </thead> <tbody> <tr> <td>1</td> <td>-40+0/-3</td> <td>30 min</td> </tr> <tr> <td>2</td> <td>Room temp.</td> <td>3 min</td> </tr> <tr> <td>3</td> <td>125+3/-0</td> <td>30 min</td> </tr> <tr> <td>4</td> <td>Room temp.</td> <td>3 min</td> </tr> </tbody> </table> <p style="text-align: center;">Cycle time : 5 cycles</p>			Step	Temperature(°C)	Time	1	-40+0/-3	30 min	2	Room temp.	3 min	3	125+3/-0	30 min	4	Room temp.	3 min
Step	Temperature(°C)	Time															
1	-40+0/-3	30 min															
2	Room temp.	3 min															
3	125+3/-0	30 min															
4	Room temp.	3 min															
Pre-treatment : Capacitor should be stored at 125 \pm 2 °C for 1 h, and apply the AC2,000 V(r.m.s.) 60 s then placed at *room condition for 24 \pm 2 h before initial measurements. (Do not apply to Char. SL) Post-treatment : Capacitor should be stored for 24 \pm 2 h at *room condition.																	

* "room condition" Temperature : 15 to 35 °C, Relative humidity : 45 to 75 %, Atmospheric pressure : 86 to 106 kPa

6. Packing specification

- Bulk type (Package : B)

The size of packing case and packing way

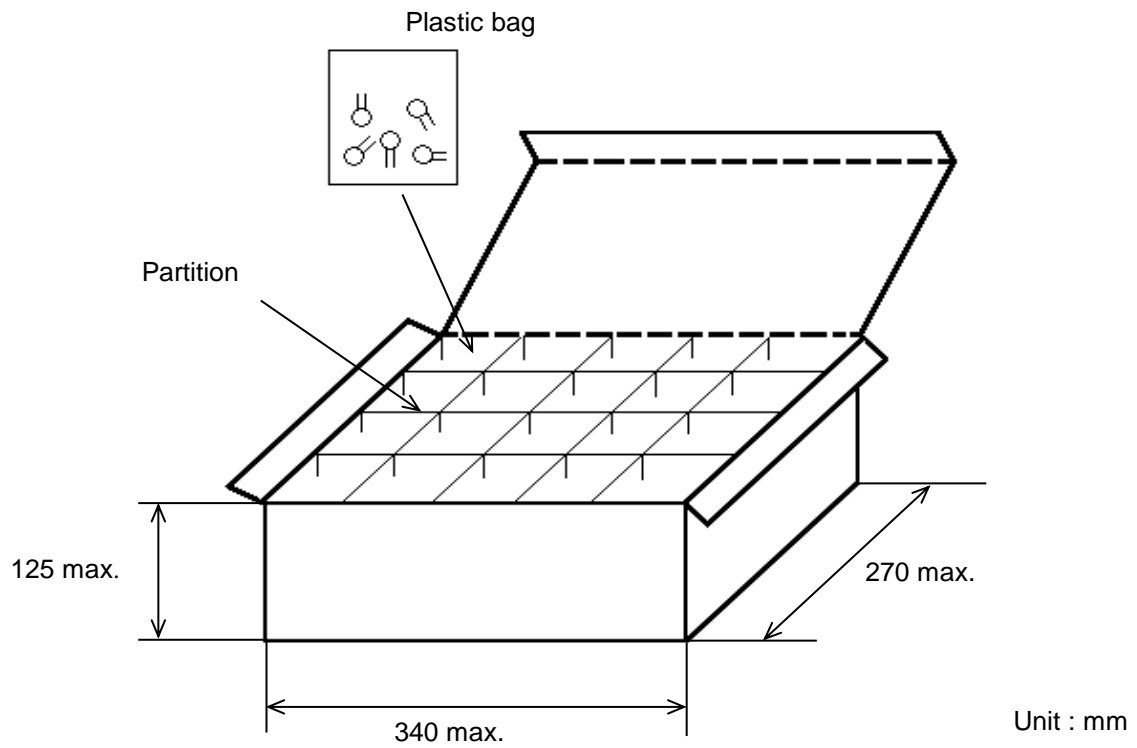

$$\text{The number of packing} = {}^{*1} \text{ Packing quantity} \times {}^{*2} n$$

*1 : Please refer to [Part number list].

*2 : Standard n = 20 (bag)

Note)

The outer package and the number of outer packing be changed by the order getting amount.

• Ammo pack taping type (Package : A)

- The tape with capacitors is packed zigzag into a case.
- When body of the capacitor is piled on other body under it.
- There should be 3 pitches and over without capacitors in leader and trailer.

The size of packing case and packing way

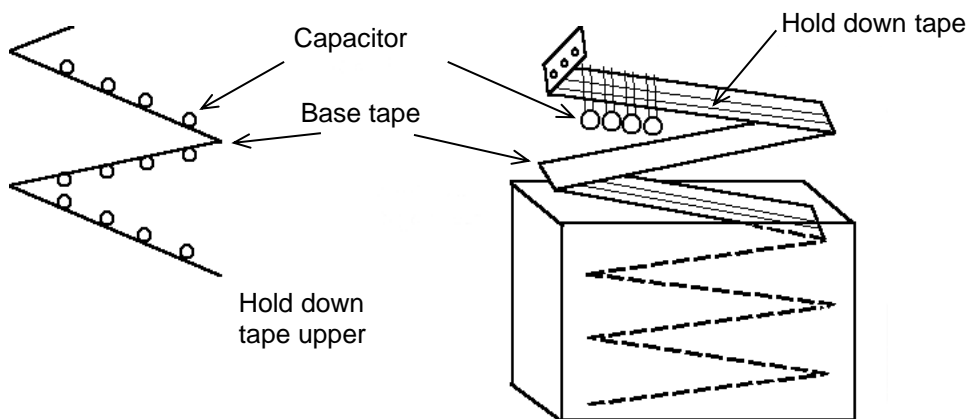
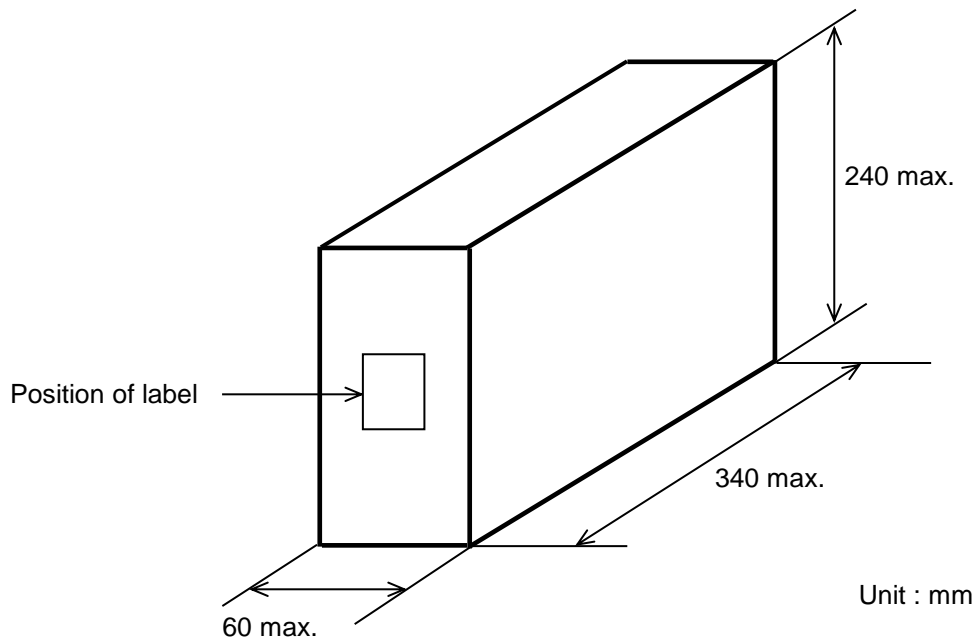

7. Taping specification

7-1. Dimension of capacitors on tape

Vertical crimp taping type < Lead Style : N3 >

Pitch of component 15.0 mm / Lead spacing 7.5 mm

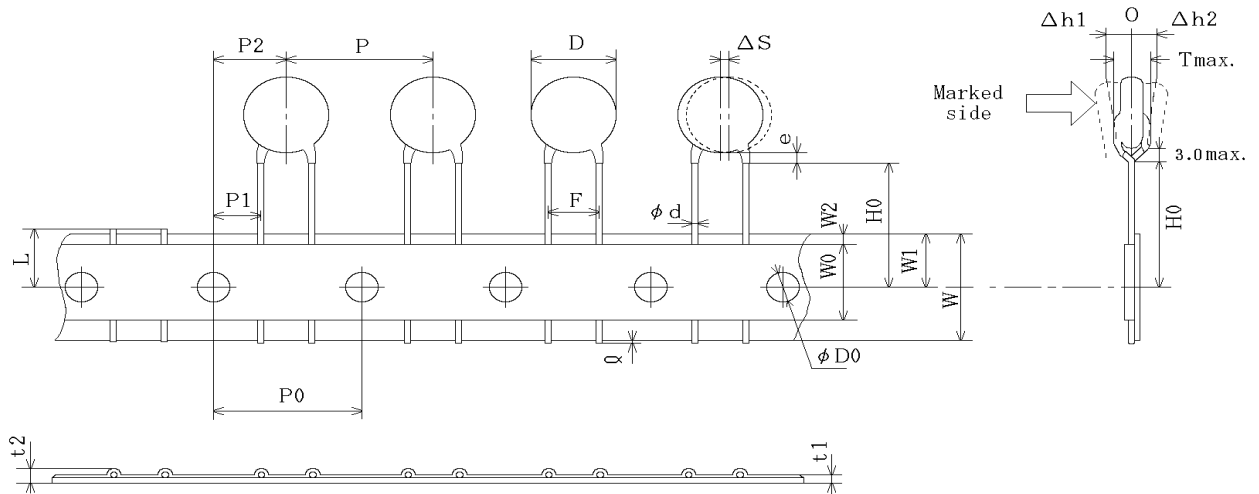

Unit : mm

Item	Code	Dimensions	Remarks
Pitch of component	P	15.0+/-2.0	
Pitch of sprocket hole	P0	15.0+/-0.3	
Lead spacing	F	7.5+/-1.0	
Length from hole center to component center	P2	7.5+/-1.5	Deviation of progress direction
Length from hole center to lead	P1	3.75+/-1.0	
Body diameter	D	Please refer to [Part number list].	
Deviation along tape, left or right	ΔS	0+/-2.0	They include deviation by lead bend.
Carrier tape width	W	18.0+/-0.5	
Position of sprocket hole	W1	9.0+/-0.5	Deviation of tape width direction
Lead distance between reference and bottom planes	H0	18.0+2.0/-0	
Protrusion length	ℓ	+0.5~-1.0	
Diameter of sprocket hole	ΦD0	4.0+/-0.1	
Lead diameter	Φd	0.60+/-0.05	
Total tape thickness	t1	0.6+/-0.3	They include hold down tape thickness.
Total thickness of tape and lead wire	t2	1.5 max.	
Deviation across tape, front	Δh1	2.0 max.	
Deviation across tape, rear	Δh2		
Portion to cut in case of defect	L	11.0+0/-1.0	
Hold down tape width	W0	11.5 min.	
Hold down tape position	W2	1.5+/-1.5	
Coating extension on lead	e	Up to the end of crimp	
Body thickness	T	Please refer to [Part number list].	

7-2. Splicing way of tape

1) Adhesive force of tape is over 3 N at test condition as below.

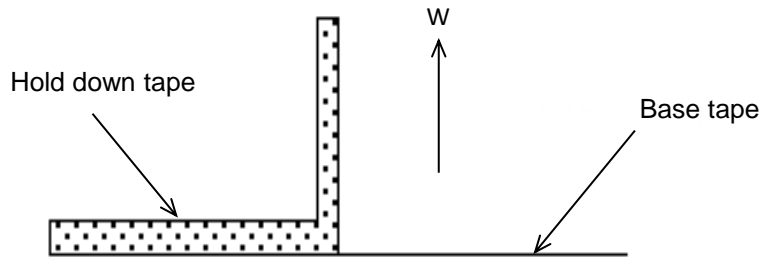

2) Splicing of tape

a) When base tape is spliced

- Base tape should be spliced by cellophane tape.
(Total tape thickness should be less than 1.05 mm.)

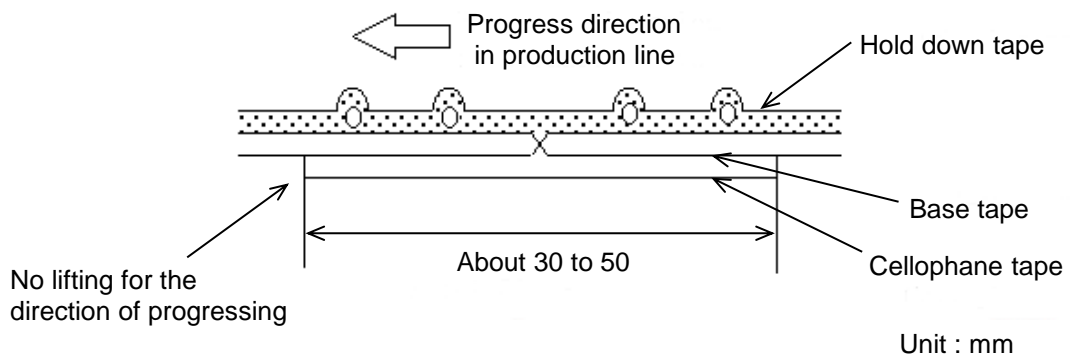

b) When hold down tape is spliced

- Hold down tape should be spliced with overlapping.
(Total tape thickness should be less than 1.05 mm.)

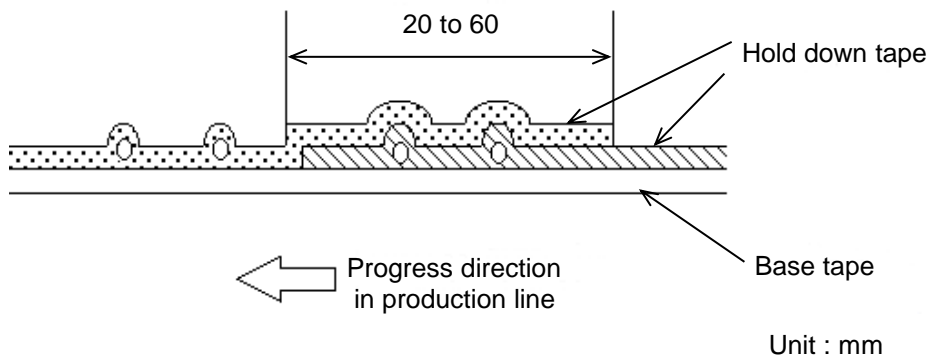

c) When both tape are spliced

- Base tape and hold down tape should be spliced with splicing tape.

3) Missing components







- There should be no consecutive missing of more than three components.
- The number of missing components should be not more than 0.5 % of total components that should be present in a Ammo pack.

Looking for pricing, stock, or lifecycle information?

Click below to explore more details on WIN SOURCE:

-  [View DE2E3SA222MN3AX02F on WIN SOURCE](#)
-  [Murata Electronics North America Information](#)

Optimize Your Supply Chain with WIN SOURCE Solutions

-  Global Sourcing Solution
-  Obsolete Management
-  Cost Control Management
-  Shortage Management
-  Alternative Solution
-  Excess Inventory Management