



**THE DATASHEET OF
UPW1V331MPD**



ALUMINUM ELECTROLYTIC CAPACITORS

UPW Miniature Sized, Low Impedance,
High Reliability For
Switching Power Supplies



- Smaller case size and lower impedance than UPM.
- Low impedance and high reliability withstanding 3000 hours to 8000 hours.
- Capacitance ranges available based on the numerical values in E12 series under JIS.
- Compliant to the RoHS directive (2011/65/EU,(EU)2015/863).
- AEC-Q200 Qualified. Please contact us for details.

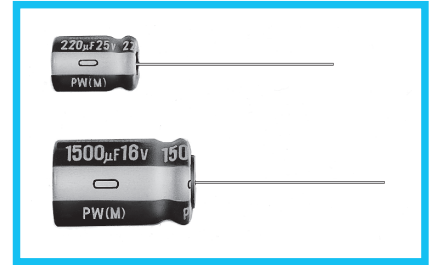
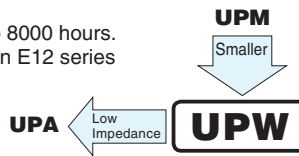

Specifications

Item	Performance Characteristics																		
Category Temperature Range	-55 to +105°C (6.3 to 100V)																		
Rated Voltage Range	6.3 to 100V																		
Rated Capacitance Range	15 to 15000µF																		
Capacitance Tolerance	±20% at 120Hz, 20°C																		
Leakage Current ※	After 1 minute's application of rated voltage at 20°C, leakage current is not more than 0.03CV(µA).																		
Tangent of loss angle (tan δ)	For capacitance of more than 1000µF, add 0.02 for every increase of 1000µF. Measurement frequency : 120Hz at 20°C <table border="1"> <tr> <td>Rated voltage (V)</td> <td>6.3</td> <td>10</td> <td>16</td> <td>25</td> <td>35</td> <td>50</td> <td>63</td> <td>100</td> </tr> <tr> <td>tan δ (max.)</td> <td>0.22</td> <td>0.19</td> <td>0.16</td> <td>0.14</td> <td>0.12</td> <td>0.10</td> <td>0.09</td> <td>0.08</td> </tr> </table>	Rated voltage (V)	6.3	10	16	25	35	50	63	100	tan δ (max.)	0.22	0.19	0.16	0.14	0.12	0.10	0.09	0.08
Rated voltage (V)	6.3	10	16	25	35	50	63	100											
tan δ (max.)	0.22	0.19	0.16	0.14	0.12	0.10	0.09	0.08											
Stability at Low Temperature	<table border="1"> <tr> <td colspan="2">120Hz</td> <td></td> <td></td> <td></td> <td></td> </tr> <tr> <td>Rated voltage (V)</td> <td>6.3 · 10</td> <td>16 · 25</td> <td>35 · 50</td> <td>63 · 100</td> <td></td> </tr> <tr> <td>Impedance ratio (max.)</td> <td>Z(-55°C) / Z(+20°C)</td> <td>3</td> <td>3</td> <td>3</td> <td>3</td> </tr> </table>	120Hz						Rated voltage (V)	6.3 · 10	16 · 25	35 · 50	63 · 100		Impedance ratio (max.)	Z(-55°C) / Z(+20°C)	3	3	3	3
120Hz																			
Rated voltage (V)	6.3 · 10	16 · 25	35 · 50	63 · 100															
Impedance ratio (max.)	Z(-55°C) / Z(+20°C)	3	3	3	3														
Endurance	<p>The specifications listed below shall be met when the capacitors are restored to 20°C after D.C. bias plus rated ripple current is applied at 105°C for the condition listed at right. The peak voltage shall not exceed the rated voltage.</p> <table border="1"> <tr> <td>Rated Voltage</td> <td>φD(mm)</td> <td>φ8</td> <td>φ10</td> <td>φ12.5</td> <td>≥φ16</td> </tr> <tr> <td>6.3~100V</td> <td></td> <td>3000hrs.</td> <td>5000hrs.</td> <td>7000hrs.</td> <td>8000hrs.</td> </tr> </table> <table border="1"> <tr> <td>Capacitance change</td> <td>Within ±20% of the initial capacitance value</td> </tr> <tr> <td>tan δ</td> <td>200% or less than the initial specified value</td> </tr> <tr> <td>Leakage current</td> <td>Less than or equal to the initial specified value</td> </tr> </table>	Rated Voltage	φD(mm)	φ8	φ10	φ12.5	≥φ16	6.3~100V		3000hrs.	5000hrs.	7000hrs.	8000hrs.	Capacitance change	Within ±20% of the initial capacitance value	tan δ	200% or less than the initial specified value	Leakage current	Less than or equal to the initial specified value
Rated Voltage	φD(mm)	φ8	φ10	φ12.5	≥φ16														
6.3~100V		3000hrs.	5000hrs.	7000hrs.	8000hrs.														
Capacitance change	Within ±20% of the initial capacitance value																		
tan δ	200% or less than the initial specified value																		
Leakage current	Less than or equal to the initial specified value																		
Shelf Life	After storing the capacitors under no load at 105°C for 1000 hours and then performing voltage treatment based on JIS C 5101-4 clause 4.1 at 20°C, they shall meet the specified values for the endurance characteristics listed above.																		
Marking	Printed with white color letter on dark brown sleeve.																		

※ I : Leakage Current (µA), C : Rated Capacitance (µF), V : Rated Voltage (V)

Radial Lead Type

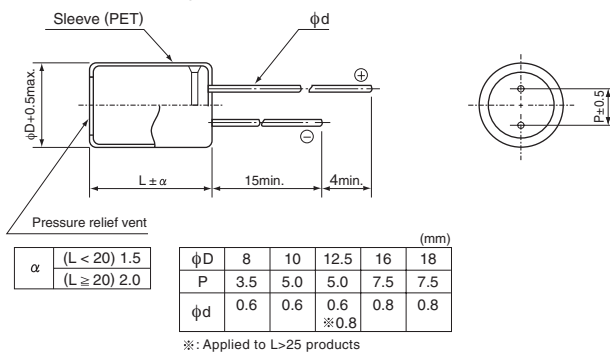

Type numbering system (Example : 10V 680µF)

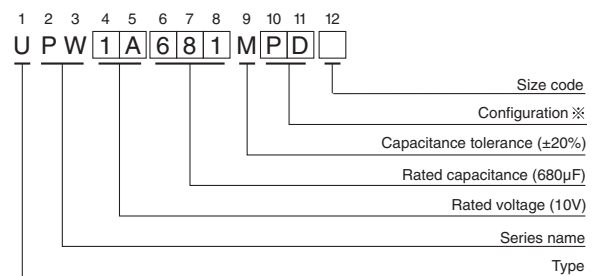

※ Configuration

φ D	Pb-free leadwire Pb-free PET sleeve
8 · 10	PD
12.5 to 18	HD

- Please refer to the Guidelines for Aluminum Electrolytic Capacitors for end seal configuration information.

Frequency coefficient of rated ripple current

Cap. (µF)	Frequency	50Hz	120Hz	300Hz	1kHz	10kHz or more
15 to 47		0.20	0.30	0.50	0.80	1.00
68 to 330		0.55	0.65	0.75	0.85	1.00
390 to 1000		0.70	0.75	0.80	0.90	1.00
1200 to 15000		0.80	0.85	0.90	0.95	1.00

• Dimension table in next page.

UPW

■ Dimensions

Rated Voltage (V) (code)	Rated Capacitance (μF)	Case Size φD×L (mm)	tan δ	Leakage Current (μA) (at 20°C after 1 minute)	Impedance (Ω) max.		Rated Ripple (mA _{rms}) (105°C/100kHz)	Part Number
					20°C/100kHz	-10°C/100kHz		
6.3 (0J)	470	8×11.5	0.22	88.83	0.117	0.234	555	UPW0J471MPD
	560	8×11.5	0.22	105.84	0.117	0.234	555	UPW0J561MPD
	680	10×12.5	0.22	128.52	0.090	0.18	755	UPW0J681MPD
	820	8×15	0.22	154.98	0.085	0.17	730	UPW0J821MPD
	820	10×12.5	0.22	154.98	0.090	0.18	755	UPW0J821MPD6
	1000	10×12.5	0.22	189	0.090	0.18	755	UPW0J102MPD
	1200	8×20	0.22	226.8	0.065	0.13	995	UPW0J122MPD
	1200	10×16	0.22	226.8	0.068	0.136	1050	UPW0J122MPD6
	1500	10×20	0.22	283.5	0.052	0.104	1220	UPW0J152MPD
	2200	12.5×20	0.24	415.8	0.038	0.076	1655	UPW0J222MHD
	2200	10×25	0.24	415.8	0.045	0.090	1440	UPW0J222MPD6
	2700	10×30.5	0.24	510.3	0.035	0.070	1815	UPW0J272MPD
	3300	12.5×20	0.26	623.7	0.038	0.076	1655	UPW0J332MHD
	3900	12.5×25	0.26	737.1	0.030	0.060	1945	UPW0J392MHD
	4700	16×25	0.28	888.3	0.022	0.044	2555	UPW0J472MHD
	4700	12.5×30.5	0.28	888.3	0.025	0.050	2310	UPW0J472MHD6
	5600	12.5×35.5	0.30	1058.4	0.022	0.044	2510	UPW0J562MHD
	5600	16×20	0.30	1058.4	0.029	0.058	2210	UPW0J562MHD6
	6800	16×25	0.32	1285.2	0.022	0.044	2560	UPW0J682MHD
	6800	18×20	0.32	1285.2	0.028	0.056	2490	UPW0J682MHD6
8200	16×30.5	0.36	1549.8	0.018	0.036	3010	UPW0J822MHD	
10000	16×30.5	0.40	1890	0.016	0.032	3150	UPW0J103MHD	
10000	18×25	0.40	1890	0.020	0.040	2740	UPW0J103MHD6	
12000	18×30.5	0.44	2268	0.016	0.032	3635	UPW0J123MHD	
15000	18×35.5	0.50	2835	0.015	0.030	3680	UPW0J153MHD	
10 (1A)	330	8×11.5	0.19	99	0.117	0.234	555	UPW1A331MPD
	470	8×11.5	0.19	141	0.117	0.234	555	UPW1A471MPD
	680	10×12.5	0.19	204	0.090	0.18	760	UPW1A681MPD
	680	8×15	0.19	204	0.085	0.17	730	UPW1A681MPD6
	1000	10×16	0.19	300	0.068	0.136	1050	UPW1A102MPD
	1000	8×20	0.19	300	0.065	0.13	995	UPW1A102MPD6
	1200	10×20	0.19	360	0.052	0.104	1220	UPW1A122MPD
	1500	10×20	0.19	450	0.052	0.104	1220	UPW1A152MPD
	1500	10×25	0.19	450	0.045	0.090	1440	UPW1A152MPD6
	2200	12.5×20	0.21	660	0.038	0.076	1655	UPW1A222MHD
	2200	10×30.5	0.21	660	0.035	0.070	1815	UPW1A222MPD6
	2700	12.5×25	0.21	810	0.030	0.060	1945	UPW1A272MHD
	3300	12.5×25	0.23	990	0.030	0.060	1950	UPW1A332MHD
	3300	12.5×30.5	0.23	990	0.025	0.050	2310	UPW1A332MHD6
	3900	12.5×35.5	0.23	1170	0.022	0.044	2510	UPW1A392MHD
	3900	16×20	0.23	1170	0.029	0.058	2210	UPW1A392MHD6
	4700	16×25	0.25	1410	0.022	0.044	2555	UPW1A472MHD
	5600	16×25	0.27	1680	0.022	0.044	2560	UPW1A562MHD
	5600	18×20	0.27	1680	0.028	0.056	2490	UPW1A562MHD6
	6800	16×30.5	0.29	2040	0.018	0.036	3010	UPW1A682MHD
	6800	18×25	0.29	2040	0.020	0.040	2740	UPW1A682MHD6
	8200	16×35.5	0.33	2460	0.016	0.032	3150	UPW1A822MHD
	8200	18×30.5	0.33	2460	0.016	0.032	3635	UPW1A822MHD6
	10000	18×35.5	0.37	3000	0.015	0.030	3680	UPW1A103MHD
	15000	18×40	0.47	4500	0.014	0.028	3800	UPW1A153MHD

For cut leads, formed leads or taped parts, please add the appropriate code after the size code (12th digit).
 If there is no size code in the part number, please add size code "1" and then add the appropriate code.

UPW

■ Dimensions

Rated Voltage (V) (code)	Rated Capacitance (μ F)	Case Size ϕ D×L (mm)	tan δ	Leakage Current (μ A) (at 20°C after 1 minute)	Impedance (Ω) max.		Rated Ripple (mA _{rms}) (105°C/100kHz)	Part Number
					20°C/ 100kHz	-10°C/ 100kHz		
16 (1C)	220	8×11.5	0.16	105.6	0.117	0.234	555	UPW1C221MPD
	330	8×11.5	0.16	158.4	0.117	0.234	555	UPW1C331MPD
	470	10×12.5	0.16	225.6	0.090	0.18	760	UPW1C471MPD
	470	8×15	0.16	225.6	0.085	0.17	730	UPW1C471MPD6
	680	10×16	0.16	326.4	0.068	0.136	1050	UPW1C681MPD
	680	8×20	0.16	326.4	0.065	0.13	995	UPW1C681MPD6
	820	10×20	0.16	393.6	0.052	0.104	1220	UPW1C821MPD
	1000	10×20	0.16	480	0.052	0.104	1220	UPW1C102MPD
	1200	10×25	0.16	576	0.045	0.090	1440	UPW1C122MPD
	1500	12.5×20	0.16	720	0.038	0.076	1655	UPW1C152MHD
	1500	10×30.5	0.16	720	0.035	0.070	1815	UPW1C152MPD6
	2200	12.5×25	0.18	1056	0.030	0.060	1945	UPW1C222MHD
	2700	12.5×30.5	0.18	1296	0.025	0.050	2310	UPW1C272MHD
	2700	16×20	0.18	1296	0.029	0.058	2210	UPW1C272MHD6
	3300	16×25	0.20	1584	0.022	0.044	2555	UPW1C332MHD
	3300	12.5×35.5	0.20	1584	0.022	0.044	2510	UPW1C332MHD6
	3900	16×25	0.20	1872	0.022	0.044	2560	UPW1C392MHD
	3900	18×20	0.20	1872	0.028	0.056	2490	UPW1C392MHD6
	4700	16×30.5	0.22	2256	0.018	0.036	3010	UPW1C472MHD
	4700	18×25	0.22	2256	0.020	0.040	2740	UPW1C472MHD6
5600	16×35.5	0.24	2688	0.016	0.032	3150	UPW1C562MHD	
5600	18×30.5	0.24	2688	0.016	0.032	3635	UPW1C562MHD6	
6800	18×35.5	0.26	3264	0.015	0.030	3680	UPW1C682MHD	
8200	18×35.5	0.30	3936	0.015	0.030	3680	UPW1C822MHD	
10000	18×40	0.34	4800	0.014	0.028	3800	UPW1C103MHD	
25 (1E)	150	8×11.5	0.14	112.5	0.117	0.234	555	UPW1E151MPD
	220	8×11.5	0.14	165	0.117	0.234	555	UPW1E221MPD
	330	10×12.5	0.14	247.5	0.090	0.18	760	UPW1E331MPD
	330	8×15	0.14	247.5	0.085	0.17	730	UPW1E331MPD6
	470	10×16	0.14	352.5	0.068	0.136	1050	UPW1E471MPD
	470	8×20	0.14	352.5	0.065	0.13	995	UPW1E471MPD6
	560	10×20	0.14	420	0.052	0.104	1220	UPW1E561MPD
	680	10×20	0.14	510	0.052	0.104	1220	UPW1E681MPD
	820	10×25	0.14	615	0.045	0.090	1440	UPW1E821MPD
	1000	12.5×20	0.14	750	0.038	0.076	1660	UPW1E102MHD
	1000	10×30.5	0.14	750	0.035	0.070	1815	UPW1E102MPD6
	1500	16×25	0.14	1125	0.022	0.044	2555	UPW1E152MHD
	1500	12.5×25	0.14	1125	0.030	0.060	1950	UPW1E152MHD6
	1800	12.5×30.5	0.14	1350	0.025	0.050	2310	UPW1E182MHD
	1800	16×20	0.14	1350	0.029	0.058	2210	UPW1E182MHD6
	2200	16×25	0.16	1650	0.022	0.044	2555	UPW1E222MHD
	2200	18×20	0.16	1650	0.028	0.056	2490	UPW1E222MHD6
	2200	12.5×35.5	0.16	1650	0.022	0.044	2510	UPW1E222MHD3
	2700	16×25	0.16	2025	0.022	0.044	2555	UPW1E272MHD
	3300	16×30.5	0.18	2475	0.018	0.036	3010	UPW1E332MHD
	3300	18×25	0.18	2475	0.020	0.040	2740	UPW1E332MHD6
	3900	16×35.5	0.18	2925	0.016	0.032	3150	UPW1E392MHD
	3900	18×30.5	0.18	2925	0.016	0.032	3635	UPW1E392MHD6
	4700	18×35.5	0.20	3525	0.015	0.030	3680	UPW1E472MHD
	6800	18×40	0.24	5100	0.014	0.028	3800	UPW1E682MHD

For cut leads, formed leads or taped parts, please add the appropriate code after the size code (12th digit).
If there is no size code in the part number, please add size code "1" and then add the appropriate code.

UPW

■ Dimensions

Rated Voltage (V) (code)	Rated Capacitance (μF)	Case Size φD×L (mm)	tan δ	Leakage Current (μA) (at 20°C after 1 minute)	Impedance (Ω) max.		Rated Ripple (mA _{rms}) (105°C/100kHz)	Part Number
					20°C/100kHz	-10°C/100kHz		
35 (1V)	100	8×11.5	0.12	105	0.117	0.234	555	UPW1V101MPD
	150	8×11.5	0.12	157.5	0.117	0.234	555	UPW1V151MPD
	220	10×12.5	0.12	231	0.090	0.18	760	UPW1V221MPD
	220	8×15	0.12	231	0.085	0.17	730	UPW1V221MPD6
	330	10×16	0.12	346.5	0.068	0.136	1050	UPW1V331MPD
	330	8×20	0.12	346.5	0.065	0.13	995	UPW1V331MPD6
	390	10×20	0.12	409.5	0.052	0.104	1220	UPW1V391MPD
	470	10×20	0.12	493.5	0.052	0.104	1220	UPW1V471MPD
	560	10×25	0.12	588	0.045	0.090	1440	UPW1V561MPD
	680	12.5×20	0.12	714	0.038	0.076	1660	UPW1V681MHD
	680	10×30.5	0.12	714	0.035	0.070	1815	UPW1V681MPD6
	1000	12.5×25	0.12	1050	0.030	0.060	1950	UPW1V102MHD
	1200	12.5×30.5	0.12	1260	0.025	0.050	2310	UPW1V122MHD
	1200	16×20	0.12	1260	0.029	0.058	2210	UPW1V122MHD6
	1500	16×25	0.12	1575	0.022	0.044	2555	UPW1V152MHD
	1500	12.5×35.5	0.12	1575	0.022	0.044	2510	UPW1V152MHD6
	1800	16×25	0.12	1890	0.022	0.044	2555	UPW1V182MHD
	1800	18×20	0.12	1890	0.028	0.056	2490	UPW1V182MHD6
	2200	16×30.5	0.14	2310	0.018	0.036	3010	UPW1V222MHD
	2200	18×25	0.14	2310	0.020	0.040	2740	UPW1V222MHD6
2700	16×35.5	0.14	2835	0.016	0.032	3150	UPW1V272MHD	
2700	18×30.5	0.14	2835	0.016	0.032	3635	UPW1V272MHD6	
3300	18×35.5	0.16	3465	0.015	0.030	3680	UPW1V332MHD	
4700	18×40	0.18	4935	0.014	0.028	3800	UPW1V472MHD	
50 (1H)	82	8×11.5	0.10	123	0.234	0.468	485	UPW1H820MPD
	100	8×11.5	0.10	150	0.234	0.468	485	UPW1H101MPD
	120	8×15	0.10	180	0.155	0.31	635	UPW1H121MPD
	120	10×12.5	0.10	180	0.162	0.324	620	UPW1H121MPD6
	150	10×12.5	0.10	225	0.162	0.324	615	UPW1H151MPD
	180	8×20	0.10	270	0.12	0.24	860	UPW1H181MPD
	180	10×16	0.10	270	0.119	0.238	850	UPW1H181MPD6
	220	10×16	0.10	330	0.119	0.238	850	UPW1H221MPD
	220	10×20	0.10	330	0.090	0.18	1030	UPW1H221MPD6
	270	10×25	0.10	405	0.082	0.164	1200	UPW1H271MPD
	330	10×20	0.10	495	0.090	0.18	1030	UPW1H331MPD
	330	10×30.5	0.10	495	0.060	0.12	1610	UPW1H331MPD6
	390	12.5×20	0.10	585	0.063	0.126	1480	UPW1H391MHD
	470	12.5×20	0.10	705	0.060	0.12	1500	UPW1H471MHD
	560	12.5×25	0.10	840	0.050	0.10	1832	UPW1H561MHD
	680	12.5×25	0.10	1020	0.050	0.10	1840	UPW1H681MHD
	680	16×20	0.10	1020	0.048	0.096	1840	UPW1H681MHD6
	820	12.5×35.5	0.10	1230	0.034	0.068	2290	UPW1H821MHD
	820	18×20	0.10	1230	0.042	0.084	2420	UPW1H821MHD6
	1000	16×25	0.10	1500	0.034	0.068	2235	UPW1H102MHD
	1200	16×30.5	0.10	1800	0.028	0.056	2700	UPW1H122MHD
	1200	18×25	0.10	1800	0.029	0.058	2610	UPW1H122MHD6
	1500	16×30.5	0.10	2250	0.028	0.056	2700	UPW1H152MHD
	1500	16×35.5	0.10	2250	0.025	0.050	2790	UPW1H152MHD6
1800	18×30.5	0.10	2700	0.025	0.050	3000	UPW1H182MHD	
2200	18×35.5	0.12	3300	0.023	0.046	3100	UPW1H222MHD	

For cut leads, formed leads or taped parts, please add the appropriate code after the size code (12th digit).
 If there is no size code in the part number, please add size code "1" and then add the appropriate code.

UPW

■ Dimensions



Rated Voltage (V) (code)	Rated Capacitance (μ F)	Case Size ϕ D×L (mm)	tan δ	Leakage Current (μ A) (at 20°C after 1 minute)	Impedance (Ω) max.		Rated Ripple (mArms) (105°C/100kHz)	Part Number
					20°C/ 100kHz	-10°C/ 100kHz		
63 (1J)	47	8×11.5	0.09	88.83	0.342	0.684	405	UPW1J470MPD
	68	8×11.5	0.09	128.52	0.342	0.684	405	UPW1J680MPD
	100	10×12.5	0.09	189	0.256	0.512	540	UPW1J101MPD
	100	8×15	0.09	189	0.23	0.46	535	UPW1J101MPD6
	120	10×16	0.09	226.8	0.194	0.388	600	UPW1J121MPD
	150	10×16	0.09	283.5	0.194	0.388	660	UPW1J151MPD
	180	10×20	0.09	340.2	0.147	0.294	890	UPW1J181MPD
	180	12.5×15	0.09	340.2	0.15	0.30	1020	UPW1J181MHD6
	220	10×20	0.09	415.8	0.147	0.294	885	UPW1J221MPD
	220	10×25	0.09	415.8	0.13	0.26	1050	UPW1J221MPD6
	270	16×15	0.09	510.3	0.090	0.18	1410	UPW1J271MHD
	330	12.5×20	0.09	623.7	0.085	0.17	1290	UPW1J331MHD
	390	12.5×25	0.09	737.1	0.070	0.14	1720	UPW1J391MHD
	390	18×15	0.09	737.1	0.086	0.172	1690	UPW1J391MHD6
	470	12.5×25	0.09	888.3	0.070	0.14	1720	UPW1J471MHD
	470	12.5×30.5	0.09	888.3	0.055	0.11	2090	UPW1J471MHD6
	470	16×20	0.09	888.3	0.059	0.118	1770	UPW1J471MHD3
	680	16×25	0.09	1285.2	0.050	0.10	2160	UPW1J681MHD
	680	12.5×35.5	0.09	1285.2	0.047	0.094	2270	UPW1J681MHD6
	680	18×20	0.09	1285.2	0.055	0.11	2290	UPW1J681MHD3
	820	16×30.5	0.09	1549.8	0.043	0.086	2670	UPW1J821MHD
	820	18×25	0.09	1549.8	0.043	0.086	2590	UPW1J821MHD6
1000	16×30.5	0.09	1890	0.043	0.086	2770	UPW1J102MHD	
1000	16×35.5	0.09	1890	0.036	0.072	2770	UPW1J102MHD6	
1200	18×30.5	0.09	2268	0.032	0.064	2950	UPW1J122MHD	
1500	18×35.5	0.09	2835	0.030	0.060	3100	UPW1J152MHD	
2200	18×40	0.11	4158	0.028	0.056	3200	UPW1J222MHD	
100 (2A)	15	8×11.5	0.08	45	0.83	1.66	180	UPW2A150MPD
	22	8×11.5	0.08	66	0.68	1.36	230	UPW2A220MPD
	33	10×12.5	0.08	99	0.46	0.92	320	UPW2A330MPD
	33	8×15	0.08	99	0.45	0.90	360	UPW2A330MPD6
	47	10×16	0.08	141	0.37	0.74	420	UPW2A470MPD
	47	8×20	0.08	141	0.37	0.74	420	UPW2A470MPD6
	68	10×20	0.08	204	0.30	0.60	490	UPW2A680MPD
	82	10×25	0.08	246	0.25	0.50	540	UPW2A820MPD
	100	12.5×20	0.08	300	0.18	0.36	580	UPW2A101MHD
	150	12.5×25	0.08	450	0.13	0.26	710	UPW2A151MHD
	180	12.5×30.5	0.08	540	0.12	0.24	790	UPW2A181MHD
	180	16×20	0.08	540	0.13	0.26	750	UPW2A181MHD6
	220	16×25	0.08	660	0.10	0.20	890	UPW2A221MHD
	220	18×20	0.08	660	0.11	0.22	850	UPW2A221MHD6
	330	16×25	0.08	990	0.090	0.18	1080	UPW2A331MHD
	390	18×25	0.08	1170	0.083	0.166	1260	UPW2A391MHD
	470	16×30.5	0.08	1410	0.076	0.152	1310	UPW2A471MHD
	560	18×30.5	0.08	1680	0.068	0.136	1370	UPW2A561MHD
	680	16×35.5	0.08	2040	0.064	0.128	1410	UPW2A681MHD
	1000	18×40	0.08	3000	0.047	0.094	1520	UPW2A102MHD

For cut leads, formed leads or taped parts, please add the appropriate code after the size code (12th digit).
If there is no size code in the part number, please add size code "1" and then add the appropriate code.







• For formed lead or taped product specifications and minimum order quantity, please refer to the Guidelines for Aluminum Electrolytic Capacitors.

Looking for pricing, stock, or lifecycle information?

Click below to explore more details on WIN SOURCE:

-  [View UPW1V331MPD on WIN SOURCE](#)
-  [Nichicon Information](#)

Optimize Your Supply Chain with WIN SOURCE Solutions

-  Global Sourcing Solution
-  Obsolete Management
-  Cost Control Management
-  Shortage Management
-  Alternative Solution
-  Excess Inventory Management