



**THE DATASHEET OF  
APX803L05-17SA-7**



## Description

The APX803L is brand new micro-power voltage detector series developed by Diodes Inc. with target to be used for microprocessor ( $\mu$ P) supervisory circuits to monitor the power supplies in  $\mu$ P and digital systems. It provides wide range of detection voltage level ranging from 1.2V to 5.0V with 0.1V per step options fixed internally from circuit design. As to supply current, APX803L series requires low supply current level of 1 $\mu$ A (typical) which gives no burden to power efficiency on systems requiring detection functions, such as smart phone, battery-powered devices, Internet equipments and so on.

These circuits perform the supervisory function by sending out a reset signal whenever it finds the monitored  $V_{CC}$  level falls below a chosen threshold voltage level and the reset signal will remain until  $V_{CC}$  recovers to a level higher than threshold voltage. The APX803L has an open-drain output with an active-low output pin and features several delay time options (0ms, 55ms, 220ms and 450ms) for system need.

The APX803L is available in two pin out variants of the 3-pin SOT23, SOT323, SC59 and SOT25 packages.

## Features

- Low Supply Current: 1.0 $\mu$ A (typ.), 2.5 $\mu$ A (max.)
- Internal Fixed 1.2V to 5.0V Threshold with 0.1V Step
- High Threshold Voltage Accuracy:  $\pm 1.5\%$
- Quick Reset within 20 $\mu$ s
- Built-in Recovery Delay Time Options: 0ms, 55ms, 220ms and 450ms
- Open-Drain Output: Active Low
- No External Components Required
- SOT23, SOT323, SC59 and SOT25 Packages
- **Totally Lead-Free & Fully RoHS Compliant (Notes 1 & 2)**
- **Halogen and Antimony Free. "Green" Device (Note 3)**

- Notes:
1. No purposely added lead. Fully EU Directive 2002/95/EC (RoHS) & 2011/65/EU (RoHS 2) compliant.
  2. See [http://www.diodes.com/quality/lead\\_free.html](http://www.diodes.com/quality/lead_free.html) for more information about Diodes Incorporated's definitions of Halogen- and Antimony-free, "Green" and Lead-free.
  3. Halogen- and Antimony-free "Green" products are defined as those which contain <900ppm bromine, <900ppm chlorine (<1500ppm total Br + Cl) and <1000ppm antimony compounds.

## Pin Assignments

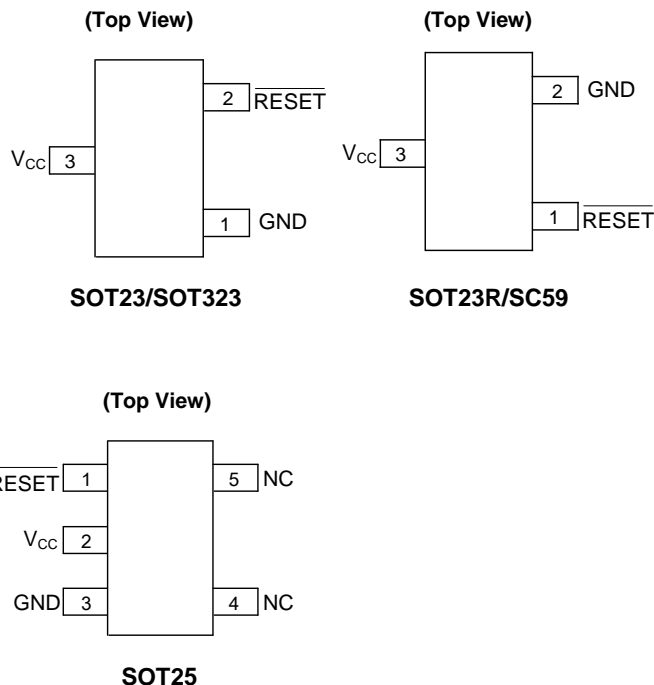

## Applications

- Computers
- Controllers
- Intelligent Instruments
- Critical  $\mu$ P and  $\mu$ C Power Monitoring
- Portable/Battery Powered Equipment

## Typical Applications Circuit



**Pin Descriptions**

Pin Number					Pin Name	Function
SOT23	SOT23R	SOT25	SOT323	SC59		
3	3	2	3	3	V <sub>CC</sub>	Operating Voltage Input
2	1	1	2	1	RESET	Reset Output Pin, Open Drain Output: Active Low
1	2	3	1	2	GND	Ground
-	-	4, 5	-	-	NC	No Connection

**Functional Block Diagram**



**Absolute Maximum Ratings** (@T<sub>A</sub> = +25°C, unless otherwise specified. Note 4)

Symbol	Parameter	Rating	Unit	
V <sub>CC</sub>	Supply Voltage	-0.3 to 6.0	V	
V <sub>RESET</sub>	RESET Voltage (Open Drain)	-0.3 to 6.0	V	
I <sub>CC</sub>	Input Current	20	mA	
I <sub>O</sub>	Output Current	20	mA	
θ <sub>JA</sub>	Thermal Resistance Junction-to-Ambient	SOT23, SOT23R, SC59	200	°C/W
		SOT25	200	
		SOT323	275	
θ <sub>JC</sub>	Thermal Resistance Junction-to-Case	SOT23, SOT23R, SC59	60	
		SOT25	60	
		SOT323	90	
ESD	HBM (Human Body Model)	±4000	V	
	MM (Machine Model)	±200		
T <sub>J</sub>	Junction Temperature Range	-40 to +150	°C	
T <sub>STG</sub>	Storage Temperature Range	-65 to +150	°C	

Note: 4. Stresses greater than those listed under "Absolute Maximum Ratings" may cause permanent damage to the device. These are stress ratings only, and functional operation of the device at these or any other conditions beyond those indicated under "Recommended Operating Conditions" is not implied. Exposure to "Absolute Maximum Ratings" for extended periods may affect device reliability.

**Recommended Operating Conditions** (@ $T_A = +25^\circ\text{C}$ , unless otherwise specified.)

Symbol	Parameter	Min	Max	Unit
$T_A$	Operating Ambient Temperature Range	-40	+85	$^\circ\text{C}$
$V_{CC}$	Supply Voltage	0.9	5.5	V
$V_{\text{RESET}}$	$\overline{\text{RESET}}$ Output Voltage	0	5.5	V

**Electrical Characteristics** (@ $T_A = +25^\circ\text{C}$ , unless otherwise specified.)

Symbol	Parameter	Test Conditions	Min	Typ	Max	Unit	
$I_{CC}$	Supply Current	$V_{TH} + 0.2\text{V}$	-	1	2.5	$\mu\text{A}$	
$V_{TH}$	Reset Threshold	$T_A = +25^\circ\text{C}$	-	1.2 to 5.0	-	V	
$\Delta V_{TH}$	Threshold Voltage Accuracy	$T_A = +25^\circ\text{C}$	-1.5	-	1.5	%	
$V_{HYS}$	Reset Threshold Hysteresis	$V_{TH,H} - V_{TH,L}$	-	$0.01V_{TH}$	$0.016V_{TH}$	mV	
$\frac{\Delta V_{TH}}{V_{TH} \times \Delta T}$	Reset Threshold Voltage Temperature Coefficient	$T_A = -40 \text{ to } +85^\circ\text{C}$	-	50	-	ppm/ $^\circ\text{C}$	
$t_s$	$V_{CC}$ Drop to $\overline{\text{RESET}}$ Delay	$V_{CC} = V_{TH}$ to $(V_{TH} - 100\text{mV})$	-	20	-	$\mu\text{s}$	
$t_{\text{DELAY}}$	Reset Active Timeout Period	APX803L-XX	$V_{CC} \geq 1.02 \times V_{TH}$	-	0	-	ms
		APX803L05-XX		35	55	75	
		APX803L20-XX		143	220	297	
		APX803L40-XX		292	450	608	
$V_{OL}$	$\overline{\text{RESET}}$ Output Voltage Low	$V_{CC} = V_{TH} - 0.2, I_{SINK} = 3.5\text{mA}$	-	-	0.4	V	

**Timing Diagram**

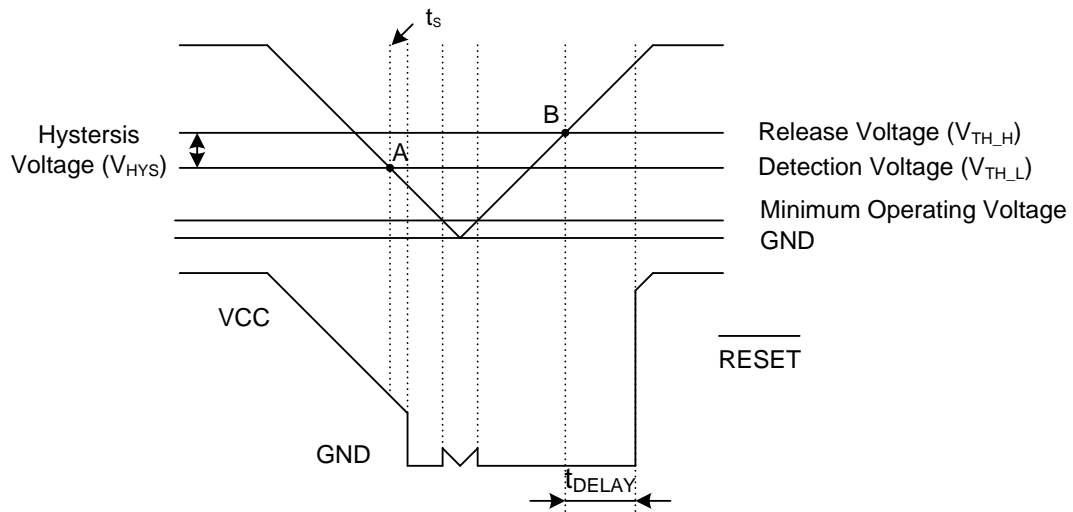

**Performance Characteristics**

NEW PRODUCT

**RESET Threshold Voltage vs. Temperature**



**RESET Threshold Voltage vs. Temperature**



**RESET Active Timeout Period vs. Temperature**



**RESET Active Timeout Period vs. Temperature**



**Supply Current vs. Temperature**



**Supply Current vs. Supply Voltage**

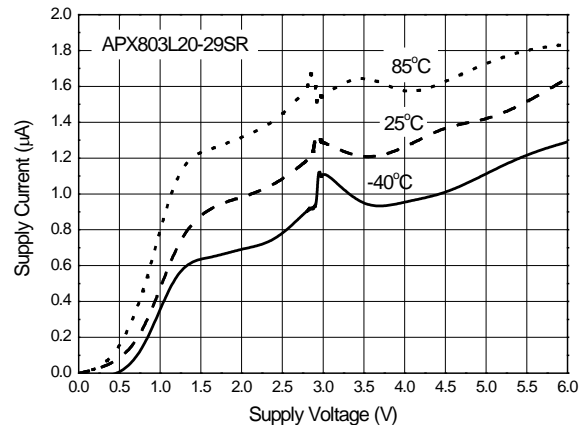

**Performance Characteristics (Cont.)**

**Output Voltage vs. Input Voltage**



**Output Voltage vs. Input Voltage**

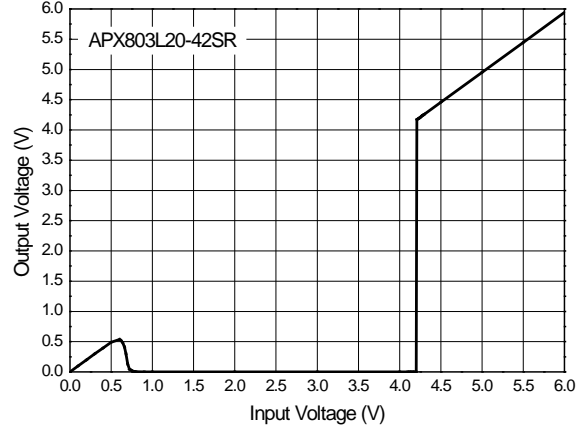

**Output Sink Current vs. Input Voltage**



**Output Sink Current vs. Input Voltage**



**Output Current vs. V<sub>DS</sub>**



**Output Current vs. V<sub>DS</sub>**

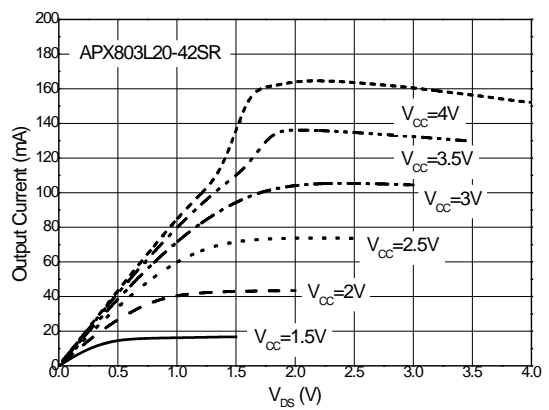

**Ordering Information**



NEW PRODUCT

Part Number	Package Code	Packaging	7" Tape and Reel	
			Quantity	Part Number Suffix
APX803L-XXSA-7	SA	SOT23	3000/Tape & Reel	-7
APX803L05-XXSA-7	SA	SOT23	3000/Tape & Reel	-7
APX803L20-XXSA-7	SA	SOT23	3000/Tape & Reel	-7
APX803L40-XXSA-7	SA	SOT23	3000/Tape & Reel	-7
APX803L-XXSR-7	SR	SOT23R	3000/Tape & Reel	-7
APX803L05-XXSR-7	SR	SOT23R	3000/Tape & Reel	-7
APX803L20-XXSR-7	SR	SOT23R	3000/Tape & Reel	-7
APX803L40-XXSR-7	SR	SOT23R	3000/Tape & Reel	-7
APX803L-XXW5-7	W5	SOT25	3000/Tape & Reel	-7
APX803L05-XXW5-7	W5	SOT25	3000/Tape & Reel	-7
APX803L20-XXW5-7	W5	SOT25	3000/Tape & Reel	-7
APX803L40-XXW5-7	W5	SOT25	3000/Tape & Reel	-7
APX803L-XXC3-7	C3	SOT323	3000/Tape & Reel	-7
APX803L05-XXC3-7	C3	SOT323	3000/Tape & Reel	-7
APX803L20-XXC3-7	C3	SOT323	3000/Tape & Reel	-7
APX803L40-XXC3-7	C3	SOT323	3000/Tape & Reel	-7
APX803L-XXW-7	W	SC59	3000/Tape & Reel	-7
APX803L05-XXW-7	W	SC59	3000/Tape & Reel	-7
APX803L20-XXW-7	W	SC59	3000/Tape & Reel	-7
APX803L40-XXW-7	W	SC59	3000/Tape & Reel	-7

**Marking Information**

1) SOT23/SOT23R/SC59

( Top View )



XXXX : Identification Code  
Y : Year 0 to 9  
W : Week : A to Z : 1 to 26 week;  
a to z : 27 to 52 week; z represents  
52 and 53 week  
X : Internal Code

2) SOT25

( Top View )

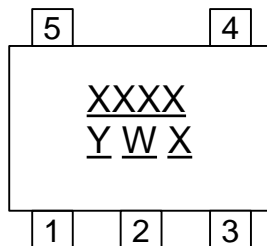

XXXX : Identification Code  
Y : Year 0 to 9  
W : Week : A to Z : 1 to 26 week;  
a to z : 27 to 52 week; z represents  
52 and 53 week  
X : Internal Code

3) SOT323

( Top View )

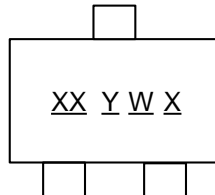

XX : Identification Code  
Y : Year 0 to 9  
W : Week : A to Z : 1 to 26 week;  
a to z : 27 to 52 week; z represents  
52 and 53 week  
X : Internal Code

### Marking Information (Cont.)

Device	Package	Identification Code	Device	Package	Identification Code
APX803L-12SA	SOT23	A212	APX803L05-12SA	SOT23	A312
APX803L-13SA	SOT23	A213	APX803L05-13SA	SOT23	A313
APX803L-14SA	SOT23	A214	APX803L05-14SA	SOT23	A314
APX803L-15SA	SOT23	A215	APX803L05-15SA	SOT23	A315
APX803L-16SA	SOT23	A216	APX803L05-16SA	SOT23	A316
APX803L-17SA	SOT23	A217	APX803L05-17SA	SOT23	A317
APX803L-18SA	SOT23	A218	APX803L05-18SA	SOT23	A318
APX803L-19SA	SOT23	A219	APX803L05-19SA	SOT23	A319
APX803L-20SA	SOT23	A220	APX803L05-20SA	SOT23	A320
APX803L-21SA	SOT23	A221	APX803L05-21SA	SOT23	A321
APX803L-22SA	SOT23	A222	APX803L05-22SA	SOT23	A322
APX803L-23SA	SOT23	A223	APX803L05-23SA	SOT23	A323
APX803L-24SA	SOT23	A224	APX803L05-24SA	SOT23	A324
APX803L-25SA	SOT23	A225	APX803L05-25SA	SOT23	A325
APX803L-26SA	SOT23	A226	APX803L05-26SA	SOT23	A326
APX803L-27SA	SOT23	A227	APX803L05-27SA	SOT23	A327
APX803L-28SA	SOT23	A228	APX803L05-28SA	SOT23	A328
APX803L-29SA	SOT23	A229	APX803L05-29SA	SOT23	A329
APX803L-30SA	SOT23	A230	APX803L05-30SA	SOT23	A330
APX803L-31SA	SOT23	A231	APX803L05-31SA	SOT23	A331
APX803L-32SA	SOT23	A232	APX803L05-32SA	SOT23	A332
APX803L-33SA	SOT23	A233	APX803L05-33SA	SOT23	A333
APX803L-34SA	SOT23	A234	APX803L05-34SA	SOT23	A334
APX803L-35SA	SOT23	A235	APX803L05-35SA	SOT23	A335
APX803L-36SA	SOT23	A236	APX803L05-36SA	SOT23	A336
APX803L-37SA	SOT23	A237	APX803L05-37SA	SOT23	A337
APX803L-38SA	SOT23	A238	APX803L05-38SA	SOT23	A338
APX803L-39SA	SOT23	A239	APX803L05-39SA	SOT23	A339
APX803L-40SA	SOT23	A240	APX803L05-40SA	SOT23	A340
APX803L-41SA	SOT23	A241	APX803L05-41SA	SOT23	A341
APX803L-42SA	SOT23	A242	APX803L05-42SA	SOT23	A342
APX803L-43SA	SOT23	A243	APX803L05-43SA	SOT23	A343
APX803L-44SA	SOT23	A244	APX803L05-44SA	SOT23	A344
APX803L-45SA	SOT23	A245	APX803L05-45SA	SOT23	A345
APX803L-46SA	SOT23	A246	APX803L05-46SA	SOT23	A346
APX803L-47SA	SOT23	A247	APX803L05-47SA	SOT23	A347
APX803L-48SA	SOT23	A248	APX803L05-48SA	SOT23	A348
APX803L-49SA	SOT23	A249	APX803L05-49SA	SOT23	A349
APX803L-50SA	SOT23	A250	APX803L05-50SA	SOT23	A350

### Marking Information (Cont.)

Device	Package	Identification Code	Device	Package	Identification Code
APX803L20-12SA	SOT23	A412	APX803L40-12SA	SOT23	A512
APX803L20-13SA	SOT23	A413	APX803L40-13SA	SOT23	A513
APX803L20-14SA	SOT23	A414	APX803L40-14SA	SOT23	A514
APX803L20-15SA	SOT23	A415	APX803L40-15SA	SOT23	A515
APX803L20-16SA	SOT23	A416	APX803L40-16SA	SOT23	A516
APX803L20-17SA	SOT23	A417	APX803L40-17SA	SOT23	A517
APX803L20-18SA	SOT23	A418	APX803L40-18SA	SOT23	A518
APX803L20-19SA	SOT23	A419	APX803L40-19SA	SOT23	A519
APX803L20-20SA	SOT23	A420	APX803L40-20SA	SOT23	A520
APX803L20-21SA	SOT23	A421	APX803L40-21SA	SOT23	A521
APX803L20-22SA	SOT23	A422	APX803L40-22SA	SOT23	A522
APX803L20-23SA	SOT23	A423	APX803L40-23SA	SOT23	A523
APX803L20-24SA	SOT23	A424	APX803L40-24SA	SOT23	A524
APX803L20-25SA	SOT23	A425	APX803L40-25SA	SOT23	A525
APX803L20-26SA	SOT23	A426	APX803L40-26SA	SOT23	A526
APX803L20-27SA	SOT23	A427	APX803L40-27SA	SOT23	A527
APX803L20-28SA	SOT23	A428	APX803L40-28SA	SOT23	A528
APX803L20-29SA	SOT23	A429	APX803L40-29SA	SOT23	A529
APX803L20-30SA	SOT23	A430	APX803L40-30SA	SOT23	A530
APX803L20-31SA	SOT23	A431	APX803L40-31SA	SOT23	A531
APX803L20-32SA	SOT23	A432	APX803L40-32SA	SOT23	A532
APX803L20-33SA	SOT23	A433	APX803L40-33SA	SOT23	A533
APX803L20-34SA	SOT23	A434	APX803L40-34SA	SOT23	A534
APX803L20-35SA	SOT23	A435	APX803L40-35SA	SOT23	A535
APX803L20-36SA	SOT23	A436	APX803L40-36SA	SOT23	A536
APX803L20-37SA	SOT23	A437	APX803L40-37SA	SOT23	A537
APX803L20-38SA	SOT23	A438	APX803L40-38SA	SOT23	A538
APX803L20-39SA	SOT23	A439	APX803L40-39SA	SOT23	A539
APX803L20-40SA	SOT23	A440	APX803L40-40SA	SOT23	A540
APX803L20-41SA	SOT23	A441	APX803L40-41SA	SOT23	A541
APX803L20-42SA	SOT23	A442	APX803L40-42SA	SOT23	A542
APX803L20-43SA	SOT23	A443	APX803L40-43SA	SOT23	A543
APX803L20-44SA	SOT23	A444	APX803L40-44SA	SOT23	A544
APX803L20-45SA	SOT23	A445	APX803L40-45SA	SOT23	A545
APX803L20-46SA	SOT23	A446	APX803L40-46SA	SOT23	A546
APX803L20-47SA	SOT23	A447	APX803L40-47SA	SOT23	A547
APX803L20-48SA	SOT23	A448	APX803L40-48SA	SOT23	A548
APX803L20-49SA	SOT23	A449	APX803L40-49SA	SOT23	A549
APX803L20-50SA	SOT23	A450	APX803L40-50SA	SOT23	A550

### Marking Information (Cont.)

Device	Package	Identification Code	Device	Package	Identification Code
APX803L-12SR	SOT23R	B212	APX803L05-12SR	SOT23R	B312
APX803L-13SR	SOT23R	B213	APX803L05-13SR	SOT23R	B313
APX803L-14SR	SOT23R	B214	APX803L05-14SR	SOT23R	B314
APX803L-15SR	SOT23R	B215	APX803L05-15SR	SOT23R	B315
APX803L-16SR	SOT23R	B216	APX803L05-16SR	SOT23R	B316
APX803L-17SR	SOT23R	B217	APX803L05-17SR	SOT23R	B317
APX803L-18SR	SOT23R	B218	APX803L05-18SR	SOT23R	B318
APX803L-19SR	SOT23R	B219	APX803L05-19SR	SOT23R	B319
APX803L-20SR	SOT23R	B220	APX803L05-20SR	SOT23R	B320
APX803L-21SR	SOT23R	B221	APX803L05-21SR	SOT23R	B321
APX803L-22SR	SOT23R	B222	APX803L05-22SR	SOT23R	B322
APX803L-23SR	SOT23R	B223	APX803L05-23SR	SOT23R	B323
APX803L-24SR	SOT23R	B224	APX803L05-24SR	SOT23R	B324
APX803L-25SR	SOT23R	B225	APX803L05-25SR	SOT23R	B325
APX803L-26SR	SOT23R	B226	APX803L05-26SR	SOT23R	B326
APX803L-27SR	SOT23R	B227	APX803L05-27SR	SOT23R	B327
APX803L-28SR	SOT23R	B228	APX803L05-28SR	SOT23R	B328
APX803L-29SR	SOT23R	B229	APX803L05-29SR	SOT23R	B329
APX803L-30SR	SOT23R	B230	APX803L05-30SR	SOT23R	B330
APX803L-31SR	SOT23R	B231	APX803L05-31SR	SOT23R	B331
APX803L-32SR	SOT23R	B232	APX803L05-32SR	SOT23R	B332
APX803L-33SR	SOT23R	B233	APX803L05-33SR	SOT23R	B333
APX803L-34SR	SOT23R	B234	APX803L05-34SR	SOT23R	B334
APX803L-35SR	SOT23R	B235	APX803L05-35SR	SOT23R	B335
APX803L-36SR	SOT23R	B236	APX803L05-36SR	SOT23R	B336
APX803L-37SR	SOT23R	B237	APX803L05-37SR	SOT23R	B337
APX803L-38SR	SOT23R	B238	APX803L05-38SR	SOT23R	B338
APX803L-39SR	SOT23R	B239	APX803L05-39SR	SOT23R	B339
APX803L-40SR	SOT23R	B240	APX803L05-40SR	SOT23R	B340
APX803L-41SR	SOT23R	B241	APX803L05-41SR	SOT23R	B341
APX803L-42SR	SOT23R	B242	APX803L05-42SR	SOT23R	B342
APX803L-43SR	SOT23R	B243	APX803L05-43SR	SOT23R	B343
APX803L-44SR	SOT23R	B244	APX803L05-44SR	SOT23R	B344
APX803L-45SR	SOT23R	B245	APX803L05-45SR	SOT23R	B345
APX803L-46SR	SOT23R	B246	APX803L05-46SR	SOT23R	B346
APX803L-47SR	SOT23R	B247	APX803L05-47SR	SOT23R	B347
APX803L-48SR	SOT23R	B248	APX803L05-48SR	SOT23R	B348
APX803L-49SR	SOT23R	B249	APX803L05-49SR	SOT23R	B349
APX803L-50SR	SOT23R	B250	APX803L05-50SR	SOT23R	B350

### Marking Information (Cont.)

Device	Package	Identification Code	Device	Package	Identification Code
APX803L20-12SR	SOT23R	B412	APX803L40-12SR	SOT23R	B512
APX803L20-13SR	SOT23R	B413	APX803L40-13SR	SOT23R	B513
APX803L20-14SR	SOT23R	B414	APX803L40-14SR	SOT23R	B514
APX803L20-15SR	SOT23R	B415	APX803L40-15SR	SOT23R	B515
APX803L20-16SR	SOT23R	B416	APX803L40-16SR	SOT23R	B516
APX803L20-17SR	SOT23R	B417	APX803L40-17SR	SOT23R	B517
APX803L20-18SR	SOT23R	B418	APX803L40-18SR	SOT23R	B518
APX803L20-19SR	SOT23R	B419	APX803L40-19SR	SOT23R	B519
APX803L20-20SR	SOT23R	B420	APX803L40-20SR	SOT23R	B520
APX803L20-21SR	SOT23R	B421	APX803L40-21SR	SOT23R	B521
APX803L20-22SR	SOT23R	B422	APX803L40-22SR	SOT23R	B522
APX803L20-23SR	SOT23R	B423	APX803L40-23SR	SOT23R	B523
APX803L20-24SR	SOT23R	B424	APX803L40-24SR	SOT23R	B524
APX803L20-25SR	SOT23R	B425	APX803L40-25SR	SOT23R	B525
APX803L20-26SR	SOT23R	B426	APX803L40-26SR	SOT23R	B526
APX803L20-27SR	SOT23R	B427	APX803L40-27SR	SOT23R	B527
APX803L20-28SR	SOT23R	B428	APX803L40-28SR	SOT23R	B528
APX803L20-29SR	SOT23R	B429	APX803L40-29SR	SOT23R	B529
APX803L20-30SR	SOT23R	B430	APX803L40-30SR	SOT23R	B530
APX803L20-31SR	SOT23R	B431	APX803L40-31SR	SOT23R	B531
APX803L20-32SR	SOT23R	B432	APX803L40-32SR	SOT23R	B532
APX803L20-33SR	SOT23R	B433	APX803L40-33SR	SOT23R	B533
APX803L20-34SR	SOT23R	B434	APX803L40-34SR	SOT23R	B534
APX803L20-35SR	SOT23R	B435	APX803L40-35SR	SOT23R	B535
APX803L20-36SR	SOT23R	B436	APX803L40-36SR	SOT23R	B536
APX803L20-37SR	SOT23R	B437	APX803L40-37SR	SOT23R	B537
APX803L20-38SR	SOT23R	B438	APX803L40-38SR	SOT23R	B538
APX803L20-39SR	SOT23R	B439	APX803L40-39SR	SOT23R	B539
APX803L20-40SR	SOT23R	B440	APX803L40-40SR	SOT23R	B540
APX803L20-41SR	SOT23R	B441	APX803L40-41SR	SOT23R	B541
APX803L20-42SR	SOT23R	B442	APX803L40-42SR	SOT23R	B542
APX803L20-43SR	SOT23R	B443	APX803L40-43SR	SOT23R	B543
APX803L20-44SR	SOT23R	B444	APX803L40-44SR	SOT23R	B544
APX803L20-45SR	SOT23R	B445	APX803L40-45SR	SOT23R	B545
APX803L20-46SR	SOT23R	B446	APX803L40-46SR	SOT23R	B546
APX803L20-47SR	SOT23R	B447	APX803L40-47SR	SOT23R	B547
APX803L20-48SR	SOT23R	B448	APX803L40-48SR	SOT23R	B548
APX803L20-49SR	SOT23R	B449	APX803L40-49SR	SOT23R	B549
APX803L20-50SR	SOT23R	B450	APX803L40-50SR	SOT23R	B550

NEW PRODUCT

### Marking Information (Cont.)

Device	Package	Identification Code	Device	Package	Identification Code
APX803L-12W5	SOT25	C212	APX803L05-12W5	SOT25	C312
APX803L-13W5	SOT25	C213	APX803L05-13W5	SOT25	C313
APX803L-14W5	SOT25	C214	APX803L05-14W5	SOT25	C314
APX803L-15W5	SOT25	C215	APX803L05-15W5	SOT25	C315
APX803L-16W5	SOT25	C216	APX803L05-16W5	SOT25	C316
APX803L-17W5	SOT25	C217	APX803L05-17W5	SOT25	C317
APX803L-18W5	SOT25	C218	APX803L05-18W5	SOT25	C318
APX803L-19W5	SOT25	C219	APX803L05-19W5	SOT25	C319
APX803L-20W5	SOT25	C220	APX803L05-20W5	SOT25	C320
APX803L-21W5	SOT25	C221	APX803L05-21W5	SOT25	C321
APX803L-22W5	SOT25	C222	APX803L05-22W5	SOT25	C322
APX803L-23W5	SOT25	C223	APX803L05-23W5	SOT25	C323
APX803L-24W5	SOT25	C224	APX803L05-24W5	SOT25	C324
APX803L-25W5	SOT25	C225	APX803L05-25W5	SOT25	C325
APX803L-26W5	SOT25	C226	APX803L05-26W5	SOT25	C326
APX803L-27W5	SOT25	C227	APX803L05-27W5	SOT25	C327
APX803L-28W5	SOT25	C228	APX803L05-28W5	SOT25	C328
APX803L-29W5	SOT25	C229	APX803L05-29W5	SOT25	C329
APX803L-30W5	SOT25	C230	APX803L05-30W5	SOT25	C330
APX803L-31W5	SOT25	C231	APX803L05-31W5	SOT25	C331
APX803L-32W5	SOT25	C232	APX803L05-32W5	SOT25	C332
APX803L-33W5	SOT25	C233	APX803L05-33W5	SOT25	C333
APX803L-34W5	SOT25	C234	APX803L05-34W5	SOT25	C334
APX803L-35W5	SOT25	C235	APX803L05-35W5	SOT25	C335
APX803L-36W5	SOT25	C236	APX803L05-36W5	SOT25	C336
APX803L-37W5	SOT25	C237	APX803L05-37W5	SOT25	C337
APX803L-38W5	SOT25	C238	APX803L05-38W5	SOT25	C338
APX803L-39W5	SOT25	C239	APX803L05-39W5	SOT25	C339
APX803L-40W5	SOT25	C240	APX803L05-40W5	SOT25	C340
APX803L-41W5	SOT25	C241	APX803L05-41W5	SOT25	C341
APX803L-42W5	SOT25	C242	APX803L05-42W5	SOT25	C342
APX803L-43W5	SOT25	C243	APX803L05-43W5	SOT25	C343
APX803L-44W5	SOT25	C244	APX803L05-44W5	SOT25	C344
APX803L-45W5	SOT25	C245	APX803L05-45W5	SOT25	C345
APX803L-46W5	SOT25	C246	APX803L05-46W5	SOT25	C346
APX803L-47W5	SOT25	C247	APX803L05-47W5	SOT25	C347
APX803L-48W5	SOT25	C248	APX803L05-48W5	SOT25	C348
APX803L-49W5	SOT25	C249	APX803L05-49W5	SOT25	C349
APX803L-50W5	SOT25	C250	APX803L05-50W5	SOT25	C350

### Marking Information (Cont.)

Device	Package	Identification Code	Device	Package	Identification Code
APX803L20-12W5	SOT25	C412	APX803L40-12W5	SOT25	C512
APX803L20-13W5	SOT25	C413	APX803L40-13W5	SOT25	C513
APX803L20-14W5	SOT25	C414	APX803L40-14W5	SOT25	C514
APX803L20-15W5	SOT25	C415	APX803L40-15W5	SOT25	C515
APX803L20-16W5	SOT25	C416	APX803L40-16W5	SOT25	C516
APX803L20-17W5	SOT25	C417	APX803L40-17W5	SOT25	C517
APX803L20-18W5	SOT25	C418	APX803L40-18W5	SOT25	C518
APX803L20-19W5	SOT25	C419	APX803L40-19W5	SOT25	C519
APX803L20-20W5	SOT25	C420	APX803L40-20W5	SOT25	C520
APX803L20-21W5	SOT25	C421	APX803L40-21W5	SOT25	C521
APX803L20-22W5	SOT25	C422	APX803L40-22W5	SOT25	C522
APX803L20-23W5	SOT25	C423	APX803L40-23W5	SOT25	C523
APX803L20-24W5	SOT25	C424	APX803L40-24W5	SOT25	C524
APX803L20-25W5	SOT25	C425	APX803L40-25W5	SOT25	C525
APX803L20-26W5	SOT25	C426	APX803L40-26W5	SOT25	C526
APX803L20-27W5	SOT25	C427	APX803L40-27W5	SOT25	C527
APX803L20-28W5	SOT25	C428	APX803L40-28W5	SOT25	C528
APX803L20-29W5	SOT25	C429	APX803L40-29W5	SOT25	C529
APX803L20-30W5	SOT25	C430	APX803L40-30W5	SOT25	C530
APX803L20-31W5	SOT25	C431	APX803L40-31W5	SOT25	C531
APX803L20-32W5	SOT25	C432	APX803L40-32W5	SOT25	C532
APX803L20-33W5	SOT25	C433	APX803L40-33W5	SOT25	C533
APX803L20-34W5	SOT25	C434	APX803L40-34W5	SOT25	C534
APX803L20-35W5	SOT25	C435	APX803L40-35W5	SOT25	C535
APX803L20-36W5	SOT25	C436	APX803L40-36W5	SOT25	C536
APX803L20-37W5	SOT25	C437	APX803L40-37W5	SOT25	C537
APX803L20-38W5	SOT25	C438	APX803L40-38W5	SOT25	C538
APX803L20-39W5	SOT25	C439	APX803L40-39W5	SOT25	C539
APX803L20-40W5	SOT25	C440	APX803L40-40W5	SOT25	C540
APX803L20-41W5	SOT25	C441	APX803L40-41W5	SOT25	C541
APX803L20-42W5	SOT25	C442	APX803L40-42W5	SOT25	C542
APX803L20-43W5	SOT25	C443	APX803L40-43W5	SOT25	C543
APX803L20-44W5	SOT25	C444	APX803L40-44W5	SOT25	C544
APX803L20-45W5	SOT25	C445	APX803L40-45W5	SOT25	C545
APX803L20-46W5	SOT25	C446	APX803L40-46W5	SOT25	C546
APX803L20-47W5	SOT25	C447	APX803L40-47W5	SOT25	C547
APX803L20-48W5	SOT25	C448	APX803L40-48W5	SOT25	C548
APX803L20-49W5	SOT25	C449	APX803L40-49W5	SOT25	C549
APX803L20-50W5	SOT25	C450	APX803L40-50W5	SOT25	C550

## Marking Information (Cont.)

Device	Package	Identification Code	Device	Package	Identification Code
APX803L-12C3	SOT323	2A	APX803L05-12C3	SOT323	4A
APX803L-13C3	SOT323	2B	APX803L05-13C3	SOT323	4B
APX803L-14C3	SOT323	2C	APX803L05-14C3	SOT323	4C
APX803L-15C3	SOT323	2D	APX803L05-15C3	SOT323	4D
APX803L-16C3	SOT323	2E	APX803L05-16C3	SOT323	4E
APX803L-17C3	SOT323	2F	APX803L05-17C3	SOT323	4F
APX803L-18C3	SOT323	2G	APX803L05-18C3	SOT323	4G
APX803L-19C3	SOT323	2H	APX803L05-19C3	SOT323	4H
APX803L-20C3	SOT323	2J	APX803L05-20C3	SOT323	4J
APX803L-21C3	SOT323	2K	APX803L05-21C3	SOT323	4K
APX803L-22C3	SOT323	2M	APX803L05-22C3	SOT323	4M
APX803L-23C3	SOT323	2N	APX803L05-23C3	SOT323	4N
APX803L-24C3	SOT323	2P	APX803L05-24C3	SOT323	4P
APX803L-25C3	SOT323	2R	APX803L05-25C3	SOT323	4R
APX803L-26C3	SOT323	2S	APX803L05-26C3	SOT323	4S
APX803L-27C3	SOT323	2T	APX803L05-27C3	SOT323	4T
APX803L-28C3	SOT323	2U	APX803L05-28C3	SOT323	4U
APX803L-29C3	SOT323	2V	APX803L05-29C3	SOT323	4V
APX803L-30C3	SOT323	2W	APX803L05-30C3	SOT323	4W
APX803L-31C3	SOT323	2X	APX803L05-31C3	SOT323	4X
APX803L-32C3	SOT323	3A	APX803L05-32C3	SOT323	5A
APX803L-33C3	SOT323	3B	APX803L05-33C3	SOT323	5B
APX803L-34C3	SOT323	3C	APX803L05-34C3	SOT323	5C
APX803L-35C3	SOT323	3D	APX803L05-35C3	SOT323	5D
APX803L-36C3	SOT323	3E	APX803L05-36C3	SOT323	5E
APX803L-37C3	SOT323	3F	APX803L05-37C3	SOT323	5F
APX803L-38C3	SOT323	3G	APX803L05-38C3	SOT323	5G
APX803L-39C3	SOT323	3H	APX803L05-39C3	SOT323	5H
APX803L-40C3	SOT323	3J	APX803L05-40C3	SOT323	5J
APX803L-41C3	SOT323	3K	APX803L05-41C3	SOT323	5K
APX803L-42C3	SOT323	3M	APX803L05-42C3	SOT323	5M
APX803L-43C3	SOT323	3N	APX803L05-43C3	SOT323	5N
APX803L-44C3	SOT323	3P	APX803L05-44C3	SOT323	5P
APX803L-45C3	SOT323	3R	APX803L05-45C3	SOT323	5R
APX803L-46C3	SOT323	3S	APX803L05-46C3	SOT323	5S
APX803L-47C3	SOT323	3T	APX803L05-47C3	SOT323	5T
APX803L-48C3	SOT323	3U	APX803L05-48C3	SOT323	5U
APX803L-49C3	SOT323	3V	APX803L05-49C3	SOT323	5V
APX803L-50C3	SOT323	3W	APX803L05-50C3	SOT323	5W

### Marking Information (Cont.)

Device	Package	Identification Code	Device	Package	Identification Code
APX803L20-12C3	SOT323	6A	APX803L40-12C3	SOT323	8A
APX803L20-13C3	SOT323	6B	APX803L40-13C3	SOT323	8B
APX803L20-14C3	SOT323	6C	APX803L40-14C3	SOT323	8C
APX803L20-15C3	SOT323	6D	APX803L40-15C3	SOT323	8D
APX803L20-16C3	SOT323	6E	APX803L40-16C3	SOT323	8E
APX803L20-17C3	SOT323	6F	APX803L40-17C3	SOT323	8F
APX803L20-18C3	SOT323	6G	APX803L40-18C3	SOT323	8G
APX803L20-19C3	SOT323	6H	APX803L40-19C3	SOT323	8H
APX803L20-20C3	SOT323	6J	APX803L40-20C3	SOT323	8J
APX803L20-21C3	SOT323	6K	APX803L40-21C3	SOT323	8K
APX803L20-22C3	SOT323	6M	APX803L40-22C3	SOT323	8M
APX803L20-23C3	SOT323	6N	APX803L40-23C3	SOT323	8N
APX803L20-24C3	SOT323	6P	APX803L40-24C3	SOT323	8P
APX803L20-25C3	SOT323	6R	APX803L40-25C3	SOT323	8R
APX803L20-26C3	SOT323	6S	APX803L40-26C3	SOT323	8S
APX803L20-27C3	SOT323	6T	APX803L40-27C3	SOT323	8T
APX803L20-28C3	SOT323	6U	APX803L40-28C3	SOT323	8U
APX803L20-29C3	SOT323	6V	APX803L40-29C3	SOT323	8V
APX803L20-30C3	SOT323	6W	APX803L40-30C3	SOT323	8W
APX803L20-31C3	SOT323	6X	APX803L40-31C3	SOT323	8X
APX803L20-32C3	SOT323	7A	APX803L40-32C3	SOT323	9A
APX803L20-33C3	SOT323	7B	APX803L40-33C3	SOT323	9B
APX803L20-34C3	SOT323	7C	APX803L40-34C3	SOT323	9C
APX803L20-35C3	SOT323	7D	APX803L40-35C3	SOT323	9D
APX803L20-36C3	SOT323	7E	APX803L40-36C3	SOT323	9E
APX803L20-37C3	SOT323	7F	APX803L40-37C3	SOT323	9F
APX803L20-38C3	SOT323	7G	APX803L40-38C3	SOT323	9G
APX803L20-39C3	SOT323	7H	APX803L40-39C3	SOT323	9H
APX803L20-40C3	SOT323	7J	APX803L40-40C3	SOT323	9J
APX803L20-41C3	SOT323	7K	APX803L40-41C3	SOT323	9K
APX803L20-42C3	SOT323	7M	APX803L40-42C3	SOT323	9M
APX803L20-43C3	SOT323	7N	APX803L40-43C3	SOT323	9N
APX803L20-44C3	SOT323	7P	APX803L40-44C3	SOT323	9P
APX803L20-45C3	SOT323	7R	APX803L40-45C3	SOT323	9R
APX803L20-46C3	SOT323	7S	APX803L40-46C3	SOT323	9S
APX803L20-47C3	SOT323	7T	APX803L40-47C3	SOT323	9T
APX803L20-48C3	SOT323	7U	APX803L40-48C3	SOT323	9U
APX803L20-49C3	SOT323	7V	APX803L40-49C3	SOT323	9V
APX803L20-50C3	SOT323	7W	APX803L40-50C3	SOT323	9W

NEW PRODUCT

### Marking Information (Cont.)

Device	Package	Identification Code	Device	Package	Identification Code
APX803L-12W	SC59	D212	APX803L05-12W	SC59	D312
APX803L-13W	SC59	D213	APX803L05-13W	SC59	D313
APX803L-14W	SC59	D214	APX803L05-14W	SC59	D314
APX803L-15W	SC59	D215	APX803L05-15W	SC59	D315
APX803L-16W	SC59	D216	APX803L05-16W	SC59	D316
APX803L-17W	SC59	D217	APX803L05-17W	SC59	D317
APX803L-18W	SC59	D218	APX803L05-18W	SC59	D318
APX803L-19W	SC59	D219	APX803L05-19W	SC59	D319
APX803L-20W	SC59	D220	APX803L05-20W	SC59	D320
APX803L-21W	SC59	D221	APX803L05-21W	SC59	D321
APX803L-22W	SC59	D222	APX803L05-22W	SC59	D322
APX803L-23W	SC59	D223	APX803L05-23W	SC59	D323
APX803L-24W	SC59	D224	APX803L05-24W	SC59	D324
APX803L-25W	SC59	D225	APX803L05-25W	SC59	D325
APX803L-26W	SC59	D226	APX803L05-26W	SC59	D326
APX803L-27W	SC59	D227	APX803L05-27W	SC59	D327
APX803L-28W	SC59	D228	APX803L05-28W	SC59	D328
APX803L-29W	SC59	D229	APX803L05-29W	SC59	D329
APX803L-30W	SC59	D230	APX803L05-30W	SC59	D330
APX803L-31W	SC59	D231	APX803L05-31W	SC59	D331
APX803L-32W	SC59	D232	APX803L05-32W	SC59	D332
APX803L-33W	SC59	D233	APX803L05-33W	SC59	D333
APX803L-34W	SC59	D234	APX803L05-34W	SC59	D334
APX803L-35W	SC59	D235	APX803L05-35W	SC59	D335
APX803L-36W	SC59	D236	APX803L05-36W	SC59	D336
APX803L-37W	SC59	D237	APX803L05-37W	SC59	D337
APX803L-38W	SC59	D238	APX803L05-38W	SC59	D338
APX803L-39W	SC59	D239	APX803L05-39W	SC59	D339
APX803L-40W	SC59	D240	APX803L05-40W	SC59	D340
APX803L-41W	SC59	D241	APX803L05-41W	SC59	D341
APX803L-42W	SC59	D242	APX803L05-42W	SC59	D342
APX803L-43W	SC59	D243	APX803L05-43W	SC59	D343
APX803L-44W	SC59	D244	APX803L05-44W	SC59	D344
APX803L-45W	SC59	D245	APX803L05-45W	SC59	D345
APX803L-46W	SC59	D246	APX803L05-46W	SC59	D346
APX803L-47W	SC59	D247	APX803L05-47W	SC59	D347
APX803L-48W	SC59	D248	APX803L05-48W	SC59	D348
APX803L-49W	SC59	D249	APX803L05-49W	SC59	D349
APX803L-50W	SC59	D250	APX803L05-50W	SC59	D350

NEW PRODUCT

### Marking Information (Cont.)

Device	Package	Identification Code	Device	Package	Identification Code
APX803L20-12W	SC59	D412	APX803L40-12W	SC59	D512
APX803L20-13W	SC59	D413	APX803L40-13W	SC59	D513
APX803L20-14W	SC59	D414	APX803L40-14W	SC59	D514
APX803L20-15W	SC59	D415	APX803L40-15W	SC59	D515
APX803L20-16W	SC59	D416	APX803L40-16W	SC59	D516
APX803L20-17W	SC59	D417	APX803L40-17W	SC59	D517
APX803L20-18W	SC59	D418	APX803L40-18W	SC59	D518
APX803L20-19W	SC59	D419	APX803L40-19W	SC59	D519
APX803L20-20W	SC59	D420	APX803L40-20W	SC59	D520
APX803L20-21W	SC59	D421	APX803L40-21W	SC59	D521
APX803L20-22W	SC59	D422	APX803L40-22W	SC59	D522
APX803L20-23W	SC59	D423	APX803L40-23W	SC59	D523
APX803L20-24W	SC59	D424	APX803L40-24W	SC59	D524
APX803L20-25W	SC59	D425	APX803L40-25W	SC59	D525
APX803L20-26W	SC59	D426	APX803L40-26W	SC59	D526
APX803L20-27W	SC59	D427	APX803L40-27W	SC59	D527
APX803L20-28W	SC59	D428	APX803L40-28W	SC59	D528
APX803L20-29W	SC59	D429	APX803L40-29W	SC59	D529
APX803L20-30W	SC59	D430	APX803L40-30W	SC59	D530
APX803L20-31W	SC59	D431	APX803L40-31W	SC59	D531
APX803L20-32W	SC59	D432	APX803L40-32W	SC59	D532
APX803L20-33W	SC59	D433	APX803L40-33W	SC59	D533
APX803L20-34W	SC59	D434	APX803L40-34W	SC59	D534
APX803L20-35W	SC59	D435	APX803L40-35W	SC59	D535
APX803L20-36W	SC59	D436	APX803L40-36W	SC59	D536
APX803L20-37W	SC59	D437	APX803L40-37W	SC59	D537
APX803L20-38W	SC59	D438	APX803L40-38W	SC59	D538
APX803L20-39W	SC59	D439	APX803L40-39W	SC59	D539
APX803L20-40W	SC59	D440	APX803L40-40W	SC59	D540
APX803L20-41W	SC59	D441	APX803L40-41W	SC59	D541
APX803L20-42W	SC59	D442	APX803L40-42W	SC59	D542
APX803L20-43W	SC59	D443	APX803L40-43W	SC59	D543
APX803L20-44W	SC59	D444	APX803L40-44W	SC59	D544
APX803L20-45W	SC59	D445	APX803L40-45W	SC59	D545
APX803L20-46W	SC59	D446	APX803L40-46W	SC59	D546
APX803L20-47W	SC59	D447	APX803L40-47W	SC59	D547
APX803L20-48W	SC59	D448	APX803L40-48W	SC59	D548
APX803L20-49W	SC59	D449	APX803L40-49W	SC59	D549
APX803L20-50W	SC59	D450	APX803L40-50W	SC59	D550

**Package Outline Dimensions**

Please see <http://www.diodes.com/package-outlines.html> for the latest version.

**(1) Package Type: SOT23**



SOT23			
Dim	Min	Max	Typ
A	0.37	0.51	0.40
B	1.20	1.40	1.30
C	2.30	2.50	2.40
D	0.89	1.03	0.915
F	0.45	0.60	0.535
G	1.78	2.05	1.83
H	2.80	3.00	2.90
J	0.013	0.10	0.05
K	0.890	1.00	0.975
K1	0.903	1.10	1.025
L	0.45	0.61	0.55
L1	0.25	0.55	0.40
M	0.085	0.150	0.110
a	0°	8°	--
All Dimensions in mm			

**(2) Package Type: SOT25**



SOT25			
Dim	Min	Max	Typ
A	0.35	0.50	0.38
B	1.50	1.70	1.60
C	2.70	3.00	2.80
D	-	-	0.95
H	2.90	3.10	3.00
J	0.013	0.10	0.05
K	1.00	1.30	1.10
L	0.35	0.55	0.40
M	0.10	0.20	0.15
N	0.70	0.80	0.75
α	0°	8°	-
All Dimensions in mm			

NEW PRODUCT

**Package Outline Dimensions (Cont.)**

Please see <http://www.diodes.com/package-outlines.html> for the latest version.

**(3) Package Type: SOT323**



SOT323			
Dim	Min	Max	Typ
A1	0.00	0.10	0.05
A2	0.90	1.00	0.95
b	0.25	0.40	0.30
c	0.10	0.18	0.11
D	1.80	2.20	2.15
E	2.00	2.20	2.10
E1	1.15	1.35	1.30
e	0.650 BSC		
e1	1.20	1.40	1.30
F	0.375	0.475	0.425
L	0.25	0.40	0.30
a	0°	8°	--
All Dimensions in mm			

**(4) Package Type: SC59**



SC59			
Dim	Min	Max	Typ
A	0.35	0.50	0.38
B	1.50	1.70	1.60
C	2.70	3.00	2.80
D	-	-	0.95
G	-	-	1.90
H	2.90	3.10	3.00
J	0.013	0.10	0.05
K	1.00	1.30	1.10
L	0.35	0.55	0.40
M	0.10	0.20	0.15
N	0.70	0.80	0.75
α	0°	8°	-
All Dimensions in mm			

NEW PRODUCT

**Suggested Pad Layout**

Please see <http://www.diodes.com/package-outlines.html> for the latest version.

(1) Package Type: SOT23

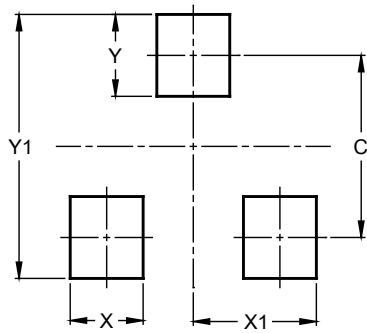

Dimensions	Value (in mm)
C	2.0
X	0.8
X1	1.35
Y	0.9
Y1	2.9

(2) Package Type: SOT25

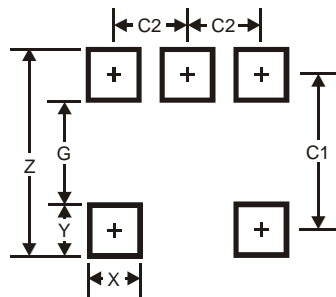

Dimensions	Value (in mm)
Z	3.20
G	1.60
X	0.55
Y	0.80
C1	2.40
C2	0.95

NEW PRODUCT

**Suggested Pad Layout (Cont.)**

Please see <http://www.diodes.com/package-outlines.html> for the latest version.

**(3) Package Type: SOT323**



Dimensions	Value (in mm)
C	0.650
G	1.300
X	0.470
Y	0.600
Y1	2.500

**(4) Package Type: SC59**



Dimensions	Value (in mm)
Z	3.4
X	0.8
Y	1.0
C	2.4
E	1.35

**IMPORTANT NOTICE**

DIODES INCORPORATED MAKES NO WARRANTY OF ANY KIND, EXPRESS OR IMPLIED, WITH REGARDS TO THIS DOCUMENT, INCLUDING, BUT NOT LIMITED TO, THE IMPLIED WARRANTIES OF MERCHANTABILITY AND FITNESS FOR A PARTICULAR PURPOSE (AND THEIR EQUIVALENTS UNDER THE LAWS OF ANY JURISDICTION).

Diodes Incorporated and its subsidiaries reserve the right to make modifications, enhancements, improvements, corrections or other changes without further notice to this document and any product described herein. Diodes Incorporated does not assume any liability arising out of the application or use of this document or any product described herein; neither does Diodes Incorporated convey any license under its patent or trademark rights, nor the rights of others. Any Customer or user of this document or products described herein in such applications shall assume all risks of such use and will agree to hold Diodes Incorporated and all the companies whose products are represented on Diodes Incorporated website, harmless against all damages.

Diodes Incorporated does not warrant or accept any liability whatsoever in respect of any products purchased through unauthorized sales channel. Should Customers purchase or use Diodes Incorporated products for any unintended or unauthorized application, Customers shall indemnify and hold Diodes Incorporated and its representatives harmless against all claims, damages, expenses, and attorney fees arising out of, directly or indirectly, any claim of personal injury or death associated with such unintended or unauthorized application.

Products described herein may be covered by one or more United States, international or foreign patents pending. Product names and markings noted herein may also be covered by one or more United States, international or foreign trademarks.

This document is written in English but may be translated into multiple languages for reference. Only the English version of this document is the final and determinative format released by Diodes Incorporated.

**LIFE SUPPORT**

Diodes Incorporated products are specifically not authorized for use as critical components in life support devices or systems without the express written approval of the Chief Executive Officer of Diodes Incorporated. As used herein:

A. Life support devices or systems are devices or systems which:

1. are intended to implant into the body, or
2. support or sustain life and whose failure to perform when properly used in accordance with instructions for use provided in the labeling can be reasonably expected to result in significant injury to the user.

B. A critical component is any component in a life support device or system whose failure to perform can be reasonably expected to cause the failure of the life support device or to affect its safety or effectiveness.

Customers represent that they have all necessary expertise in the safety and regulatory ramifications of their life support devices or systems, and acknowledge and agree that they are solely responsible for all legal, regulatory and safety-related requirements concerning their products and any use of Diodes Incorporated products in such safety-critical, life support devices or systems, notwithstanding any devices- or systems-related information or support that may be provided by Diodes Incorporated. Further, Customers must fully indemnify Diodes Incorporated and its representatives against any damages arising out of the use of Diodes Incorporated products in such safety-critical, life support devices or systems.

Copyright © 2016, Diodes Incorporated

[www.diodes.com](http://www.diodes.com)

## Looking for pricing, stock, or lifecycle information?

Click below to explore more details on WIN SOURCE:

- ⊖ [View APX803L05-17SA-7 on WIN SOURCE](#)
- ⊖ [Diodes Incorporated Information](#)

## Optimize Your Supply Chain with WIN SOURCE Solutions

- ✓ Global Sourcing Solution
- ✓ Obsolete Management
- ✓ Cost Control Management
- ✓ Shortage Management
- ✓ Alternative Solution
- ✓ Excess Inventory Management