



THE DATASHEET OF B3W-1000



Through-hole-mounting Switches That Are Mounting-compatible with B3F Series.

Sealed Structure for High Reliability

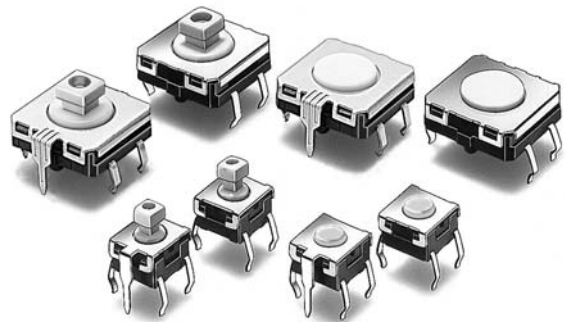

- Sealed construction conforming to IP67 (IEC-60529) provides high reliability in locations exposed to dust or water. (* Excluding the terminal section.)
- Available in two sizes: 6 × 6 mm and 12 × 12 mm sizes.
- Ground terminal available to protect against static electricity.
- B32-series Key Tops mount to models with projected plungers.



RoHS Compliant



■ List of Models

6 × 6 mm Models

| Type | Contact material | Plunger | Height | Operating force (OF) | Plunger color | Bags | | | |
|-----------------|------------------|---|--------|----------------------|---------------|-------------------------|----------------------|----------------------|----------------------|
| | | | | | | Without ground terminal | Minimum packing unit | With ground terminal | Minimum packing unit |
| B3W-1000 Series | Silver plated | Flat type  | 4.3 mm | 1.57 N {160 gf} max. | White | B3W-1000 | 100 pcs | B3W-1100 | 100 pcs |
| | | | | 2.26 N {230 gf} max. | Yellow | B3W-1002 | | B3W-1102 | |
| | | | 5.0 mm | 1.57 N {160 gf} max. | White | B3W-1020 | | --- | |
| | | | | 2.26 N {230 gf} max. | Yellow | B3W-1022 | | --- | |
| | | Projected type  | 7.3 mm | 1.57 N {160 gf} max. | White | B3W-1050 | | B3W-1150 | |
| | | | | 2.26 N {230 gf} max. | Yellow | B3W-1052 | | B3W-1152 | |

Note: Bulk Packaged, 100 switches per bag. Order in multiples of the package quantity.

12 × 12 mm Models

| Type | Contact material | Plunger | Height | Operating force (OF) | Plunger color | Bags | | | |
|-----------------|------------------|---|--------|----------------------|---------------|-------------------------|----------------------|----------------------|----------------------|
| | | | | | | Without ground terminal | Minimum packing unit | With ground terminal | Minimum packing unit |
| B3W-4000 Series | Silver plated | Flat type  | 4.3 mm | 1.96 N {200 gf} max. | White | B3W-4000 | 100 pcs | B3W-4100 | 100 pcs |
| | | | | 3.43 N {350 gf} max. | Yellow | B3W-4005 | | B3W-4105 | |
| | | Projected type  | 7.3 mm | 1.96 N {200 gf} max. | White | B3W-4050 | | B3W-4150 | |
| | | | | 3.43 N {350 gf} max. | Yellow | B3W-4055 | | B3W-4155 | |

Note: Bulk Packaged, 100 switches per bag. Order in multiples of the package quantity.

■ Ratings/Characteristics

| | |
|---|--|
| Rating (resistive load) | 1 to 50 mA, 3 to 24 VDC |
| Minimum applicable load (reference value) | 10 μ A at 1 VDC (resistive load) |
| Ambient operating temperature | -25°C to +70°C at 60%RH max. (with no icing or condensation) |
| Ambient operating humidity | 35% to 85% (at +5 to +35°C) |
| Contact form | SPST-NO |
| Contact resistance (initial value) | 100 m Ω max. |
| Insulation resistance | 100 M Ω min. (at 250 VDC with insulation tester) |
| Dielectric strength | 500 VAC, 50/60 Hz for 1 min |
| Bounce time | 5 ms max. |
| Vibration resistance | Malfunction: 10 to 55 Hz, 1.5 mm double amplitude |
| Shock resistance | Destruction: 1,000 m/s ² {approx. 100 G} max. Malfunction: 100 m/s ² {approx. 10 G} max. |
| Durability | B3W-1000: 1.57 N (standard force):1,000,000 operations min. 2.26 N (high-force):300,000 operations min. B3W-4000: 1.96 N (standard force):3,000,000 operations min. 3.43 N (high-force):1,000,000 operations min. |
| Weight | 6 \times 6 mm: approx. 0.3 g, 12 \times 12 mm: approx. 1 g |
| Degree of protection | IEC IP67 |
| Washing | Possible |

■ Operating Characteristics

6 \times 6 mm Models

| Item | Type Operating force (OF) Model | B3W-1000 series | |
|----------------------|---------------------------------------|---|----------------------|
| | | 1.57 N | 2.26 N |
| | | B3W-1□□0 | B3W-1□□2 |
| Operating force (OF) | | 1.57 N {160 gf} max. | 2.26 N {230 gf} max. |
| Releasing force (RF) | | 0.2 N {20 gf} min. | 0.49 N {50 gf} min. |
| Pretravel (PT) | | 0.25 ^{+0.2} / _{-0.1} mm | |

12 \times 12 mm Models

| Item | Type Operating force (OF) Model | B3W-4000 series | |
|----------------------|---------------------------------------|--|----------------------|
| | | 1.96 N | 3.43 N |
| | | B3W-4□□0 | B3W-4□□5 |
| Operating force (OF) | | 1.96 N {200 gf} max. | 3.43 N {350 gf} max. |
| Releasing force (RF) | | 0.29 N {30 gf} min. | 0.49 N {50 gf} min. |
| Pretravel (PT) | | 0.3 ^{+0.2} / _{-0.1} mm | |

■ Model Structure

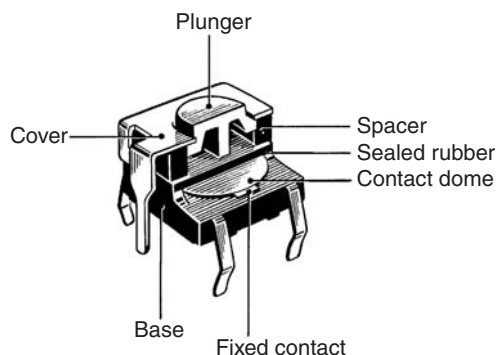

■ Dimensions (Unit: mm)

Note: The numbers used for terminals in the following graphics are indicated in the "Bottom View" diagram below. In this diagram, the Switch is rotated so that the terminals are on the right and left-hand sides, and the OMRON logo appears the right way up.



■ 6 × 6 mm Models

**Flat Plunger Type
(without Ground
Terminal)**
B3W-1000
B3W-1002

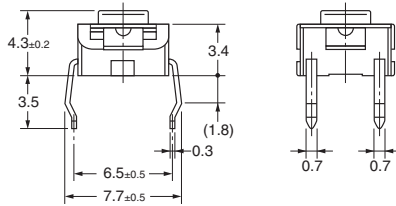
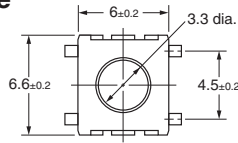

**Flat Plunger Type
(with Ground
Terminal)**
B3W-1100
B3W-1102

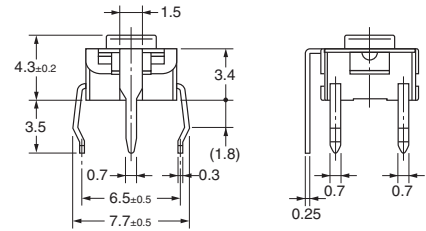
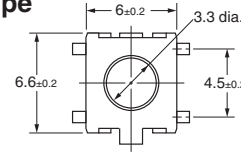

**PCB Processing Dimensions
(Reference Only) (Top View)**
(PCB thickness, t=1.6)

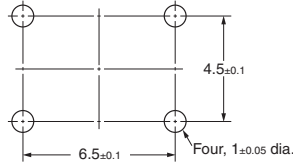

**Terminal Arrangement
/Internal Connections
(Top View)**

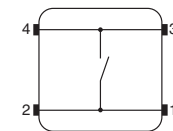

**PCB Processing Dimensions
(Reference Only) (Top View)**
(PCB thickness, t=1.6)

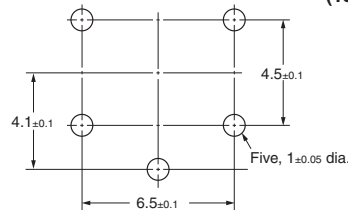

**Terminal Arrangement
/Internal Connections
(Top View)**

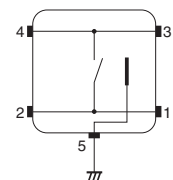

**Flat Plunger Type
(without Ground
Terminal)**
B3W-1020
B3W-1022

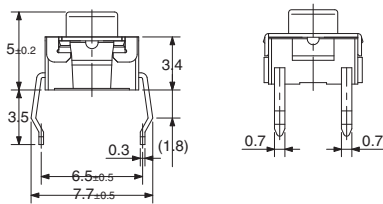
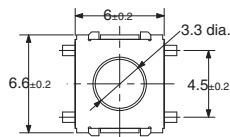

**PCB Processing Dimensions
(Reference Only) (Top View)**
(PCB thickness, t=1.6)

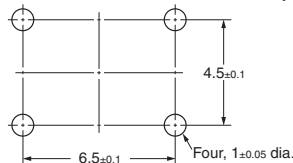

**Terminal Arrangement
/Internal Connections
(Top View)**

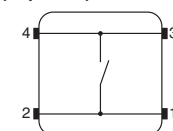

Note: Unless otherwise specified, a tolerance of ±0.4 mm applies to all dimensions. No terminal numbers are indicated on the Switches.

**Projected Plunger Type
(without Ground Terminal)**

B3W-1050
B3W-1052

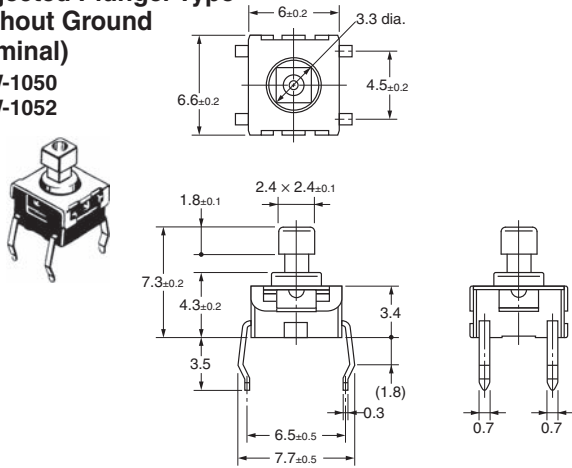

**Projected Plunger Type
(with Ground Terminal)**

B3W-1150
B3W-1152

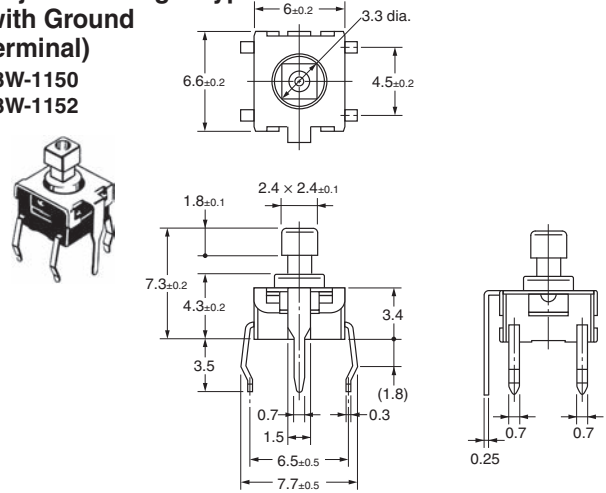

**PCB Processing Dimensions
(Reference Only) (Top View)
(PCB thickness, t=1.6)**

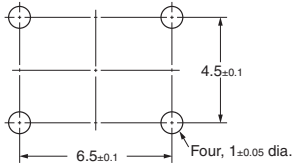

**Terminal Arrangement
/Internal Connections
(Top View)**

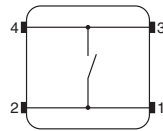

**PCB Processing Dimensions
(Reference Only) (Top View)
(PCB thickness, t=1.6)**

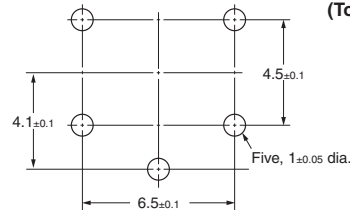

**Terminal Arrangement
/Internal Connections
(Top View)**

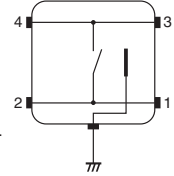

Note: Unless otherwise specified, a tolerance of ± 0.4 mm applies to all dimensions. No terminal numbers are indicated on the Switches.

■ 12 × 12 mm Models

**Flat Plunger Type
(without Ground Terminal)**

B3W-4000
B3W-4005

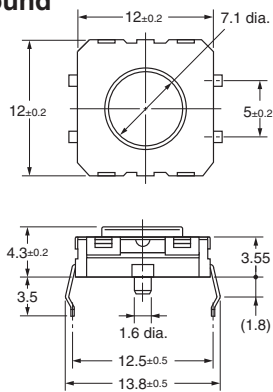
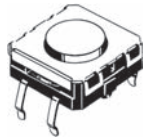

**Flat Plunger Type
(with Ground Terminal)**

B3W-4100
B3W-4105

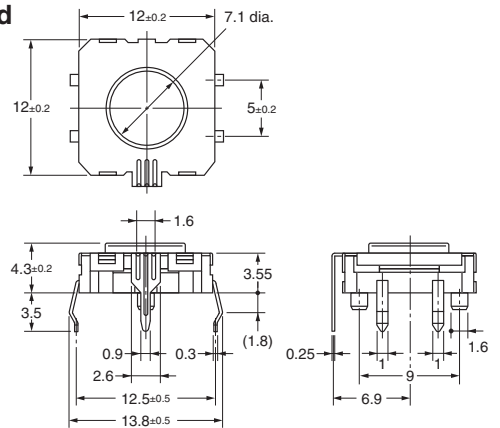

**PCB Processing Dimensions
(Reference Only) (Top View)
(PCB thickness, t=1.6)**

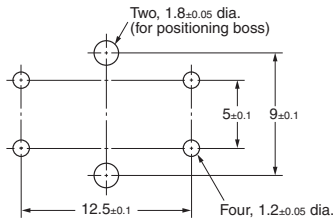

**Terminal Arrangement
/Internal Connections
(Top View)**

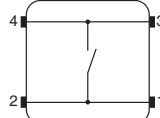

**PCB Processing Dimensions
(Reference Only) (Top View)
(PCB thickness, t=1.6)**

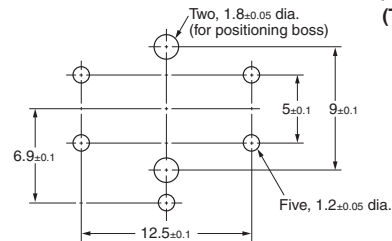

**Terminal Arrangement
/Internal Connections
(Top View)**

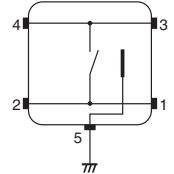

**Projected Plunger Type
(without Ground Terminal)**

B3W-4050
B3W-4055

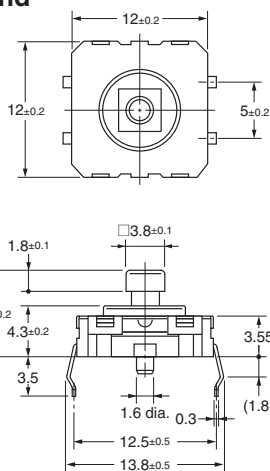

**Projected Plunger Type
(with Ground Terminal)**

B3W-4150
B3W-4155

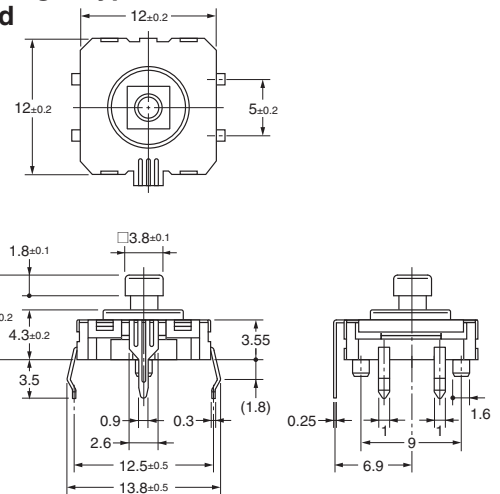
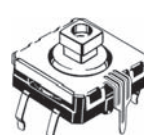

**PCB Processing Dimensions
(Reference Only) (Top View)
(PCB thickness, t=1.6)**

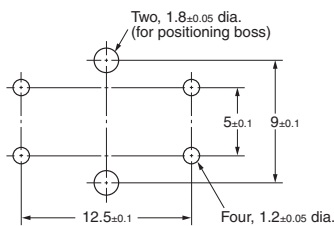

**Terminal Arrangement
/Internal Connections
(Top View)**

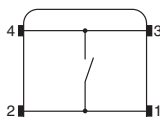

**PCB Processing Dimensions
(Reference Only) (Top View)
(PCB thickness, t=1.6)**

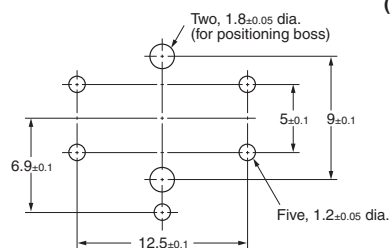

**Terminal Arrangement
/Internal Connections
(Top View)**

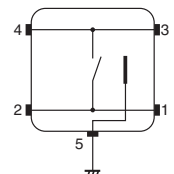

Note: Unless otherwise specified, a tolerance of ±0.4 mm applies to all dimensions.

■ Key Tops

B32-series Key Tops are available for projected plungers. Refer to the datasheet for the B32 for details.

■ Precautions

Be sure to read the safety precautions common to all Tactile Switches for correct use.

- Application examples provided in this document are for reference only. In actual applications, confirm equipment functions and safety before using the product.
- Consult your OMRON representative before using the product under conditions which are not described in the manual or applying the product to nuclear control systems, railroad systems, aviation systems, vehicles, combustion systems, medical equipment, amusement machines, safety equipment, and other systems or equipment that may have a serious influence on lives and property if used improperly. Make sure that the ratings and performance characteristics of the product provide a margin of safety for the system or equipment, and be sure to provide the system or equipment with double safety mechanisms.

Note: Do not use this document to operate the Unit.



OMRON Corporation
Electronic and Mechanical Components Company

Contact: www.omron.com/ecb

Cat. No. A075-E1-07
1014(0207)(O)

Looking for pricing, stock, or lifecycle information?

Click below to explore more details on WIN SOURCE:

-  [View B3W-1000 on WIN SOURCE](#)
-  [Omron Information](#)

Optimize Your Supply Chain with WIN SOURCE Solutions

-  Global Sourcing Solution
-  Obsolete Management
-  Cost Control Management
-  Shortage Management
-  Alternative Solution
-  Excess Inventory Management