



THE DATASHEET OF SDT23C24L02-AT



DATA SHEET

**ELECTROSTATIC DISCHARGE
PROTECTION DEVICES**

INDUSTRIAL / CONSUMER

SDT23CXXL02 SERIES

RoHS compliant & Halogen free



Product specification—June 30, 2023 V.3



Electrostatic Discharged Protection Devices (ESD) Data Sheet

Description

Brightking's SDT23CXXL02 series are designed to protect sensitive electronics from damage or latch-up due to ESD and other voltage induced transient events. They are designed for use in applications where board space is at a premium. The devices will protect up to two lines. They are bidirectional devices and may be used on lines where the signal polarities are above ground. TVS diodes are solid state device designed specifically for transient suppression.

They feature large cross-sectional area junctions for conduction high transient currents. They offer desirable characteristics for board level protection including fast response time, low and clamping voltage, and no device degradation. The devices may be used to meet the immunity requirements of IEC61000-4-2, level 4. The size SOT-23 package makes them ideal for use in portable electronics such as RS-422 I/Os, RS-232 I/Os, notebook computers, and servers.



Contact : $\pm 30\text{kV}$
Air : $\pm 30\text{kV}$



Features

- IEC61000-4-2 ESD 30KV Air, 30KV contact compliance
- SOT-23 surface mount package
- Protects bidirectional two I/O lines
- Peak power dissipation of 350W under 8/20 μs waveform
- Working voltage: 5V,15V,24V
- Low leakage current
- Low operating and clamping voltages
- Solid-state silicon avalanche technology
- Lead Free/RoHS compliant
- Solder reflow temperature: Pure Tin-Sn, 260~270°C
- Flammability rating UL 94V-0
- Meets MSL level 1, per J-STD-020

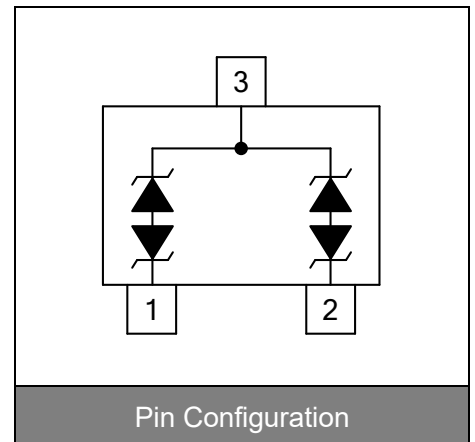

Applications

- RS-232 and RS-422 data lines
- Microprocessor based equipment
- LAN/WAN equipment
- Desktops PC and servers
- Notebook, Laptop and Palmtop computers
- Set Top Box
- Peripherals
- Serial and Parallel ports

Maximum Ratings

Rating	Symbol	Value	Unit
Peak pulse power (tp=8/20μs waveform)	P _{PP}	350	W
ESD voltage (Contact discharge)	V _{ESD}	±30	kV
ESD voltage (Air discharge)		±30	
Storage & operating temperature range	T _{STG} , T _J	-55~+150	°C

Electrical Characteristics (T_J=25°C)

SDT23C05L02 (Marking: C05)

Parameter	Symbol	Condition	Min.	Typ.	Max.	Unit
Reverse stand-off voltage	V _{RWM}				5	V
Reverse breakdown voltage	V _{BR}	I _{BR} =1mA	6			V
Reverse leakage current	I _R	V _R =5V Each I/O pin			5	μA
Clamping voltage (tp=8/20μs)	V _C	I _{PP} =1A			9.8	V
Clamping voltage (tp=8/20μs)	V _C	I _{PP} =10A			18	V
Peak Pulse Current(tp=8/20μs)	I _{PP}				17	A
Off state junction capacitance	C _J	0Vdc, f=1MHz Between I/O pins and GND		150		pF

SDT23C15L02 (Marking: C15)

Parameter	Symbol	Condition	Min.	Typ.	Max.	Unit
Reverse stand-off voltage	V _{RWM}				15	V
Reverse breakdown voltage	V _{BR}	I _{BR} =1mA	16.7			V
Reverse leakage current	I _R	V _R =15V Each I/O pin			1	μA
Clamping voltage (tp=8/20μs)	V _C	I _{PP} =1A			24	V
Clamping voltage (tp=8/20μs)	V _C	I _{PP} =10A			38	V
Peak Pulse Current(tp=8/20μs)	I _{PP}				10	A
Off state junction capacitance	C _J	0Vdc, f=1MHz Between I/O pins and GND		60		pF

SDT23C24L02 (Marking: C24)

Parameter	Symbol	Condition	Min.	Typ.	Max.	Unit
Reverse stand-off voltage	V_{RWM}				24	V
Reverse breakdown voltage	V_{BR}	$I_{BR}=1mA$	26.7			V
Reverse leakage current	I_R	$V_R=24V$ Each I/O pin			1	μA
Clamping voltage (tp=8/20 μs)	V_C	$I_{PP}=1A$			43	V
Clamping voltage (tp=8/20 μs)	V_C	$I_{PP}=5A$			52	V
Peak Pulse Current(tp=8/20 μs)	I_{PP}				5	A
Off state junction capacitance	C_J	0Vdc, f=1MHz Between I/O pins and GND		40		pF

Typical Characteristics Curves

Figure 1. Power Derating Curve

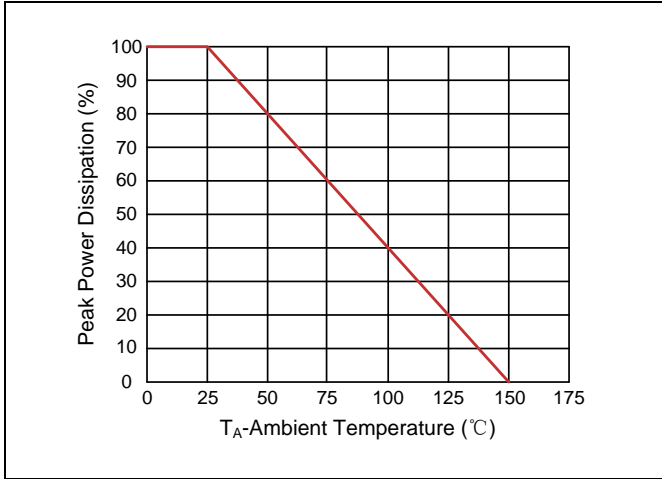

Figure 2. Pulse Waveforms

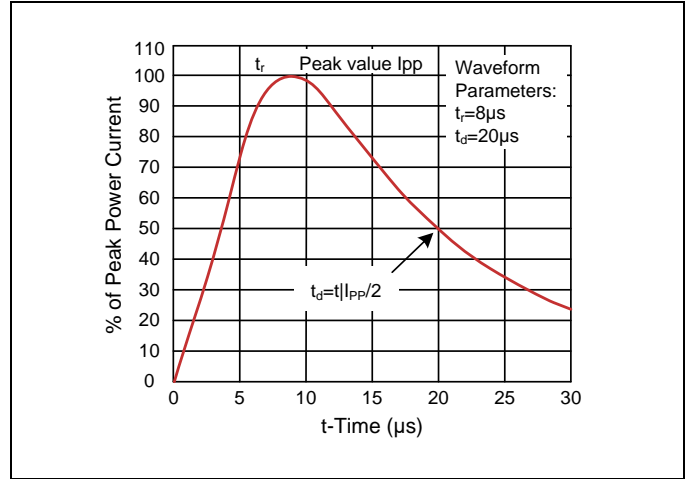

Figure 3. Non-Repetitive Peak Pulse vs. Pulse Time

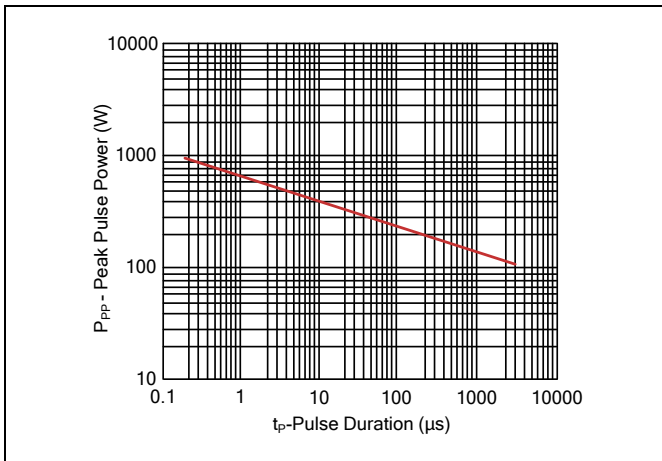

Figure 4. Normalized Capacitance vs. Reverse Voltage

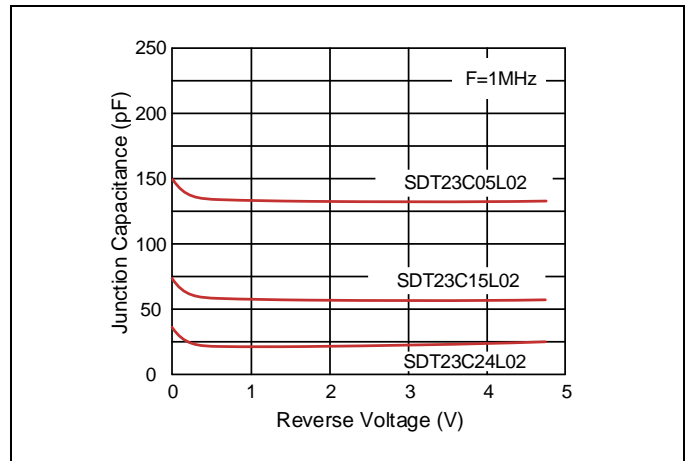

Figure 5. ESD Clamping(8kV Contact IEC61000-4-2)

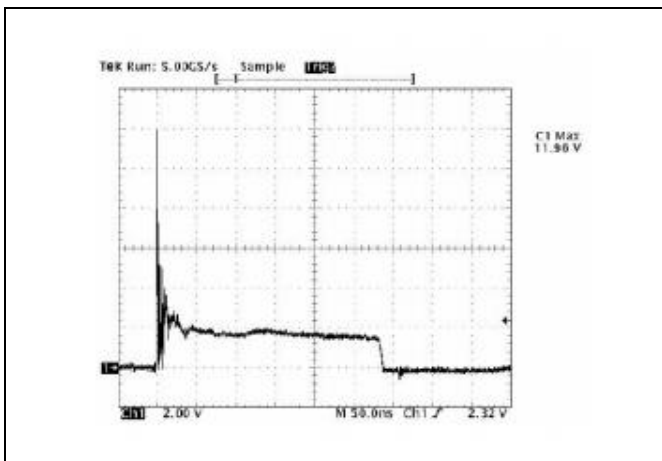
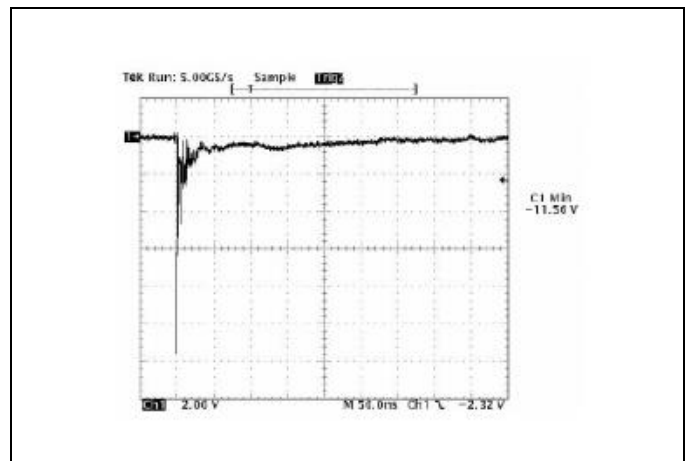
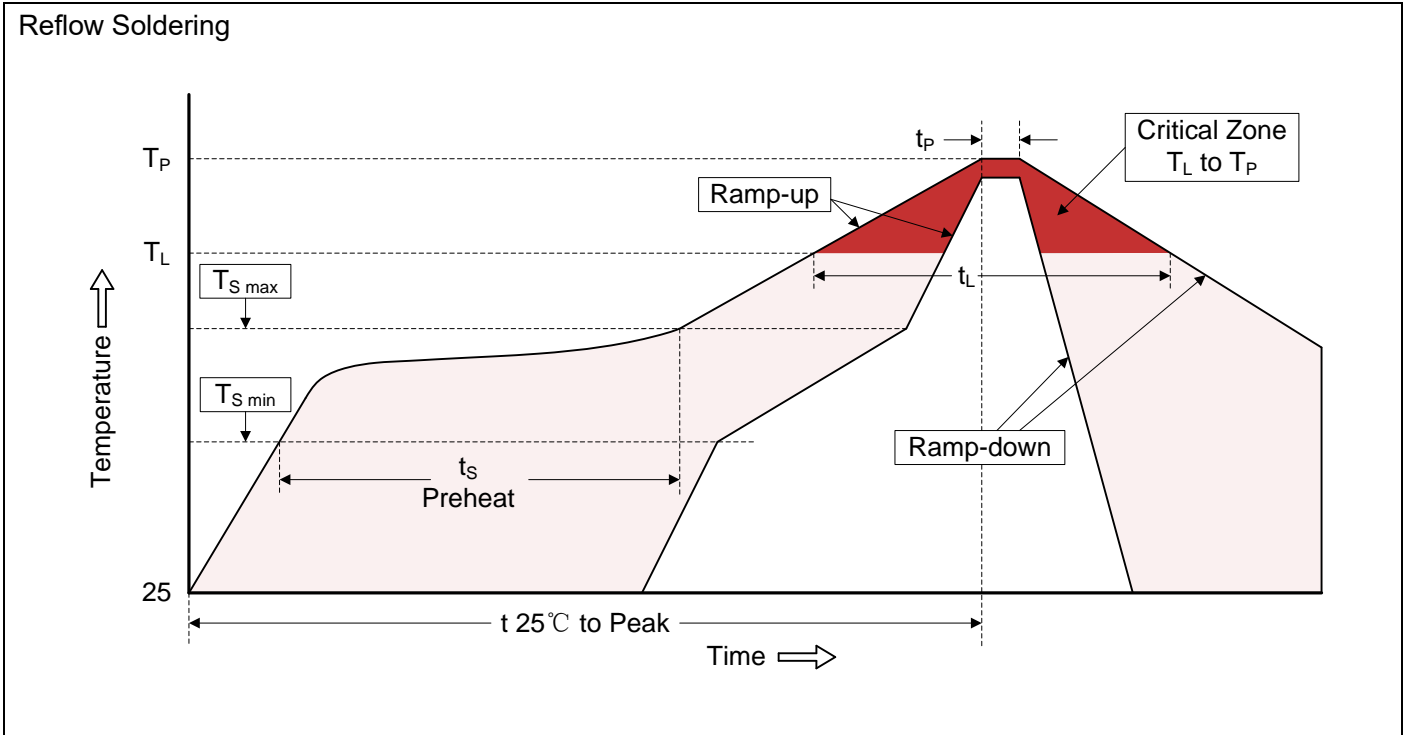

Figure 6. ESD Clamping(-8kV Contact IEC61000-4-2)



Recommended Soldering Conditions



Recommended Conditions

Profile Feature	Pb-Free Assembly
Average ramp-up rate (T_L to T_P)	3°C/second max.
Preheat -Temperature Min ($T_{S\ min}$) -Temperature Max ($T_{S\ max}$) -Time (min to max) (t_s)	150°C 200°C 60-180 seconds
$T_{S\ max}$ to T_L -Ramp-up Rate	3°C/second max.
Time maintained above: -Temperature (T_L) -Time (t_L)	217°C 60-150 seconds
Peak Temperature (T_P)	260°C
Time within 5°C of actual Peak Temperature (t_p)	20-40 seconds
Ramp-down Rate	6°C/second max.
Time 25°C to Peak Temperature	8 minutes max.

Dimensions (SOT-23)

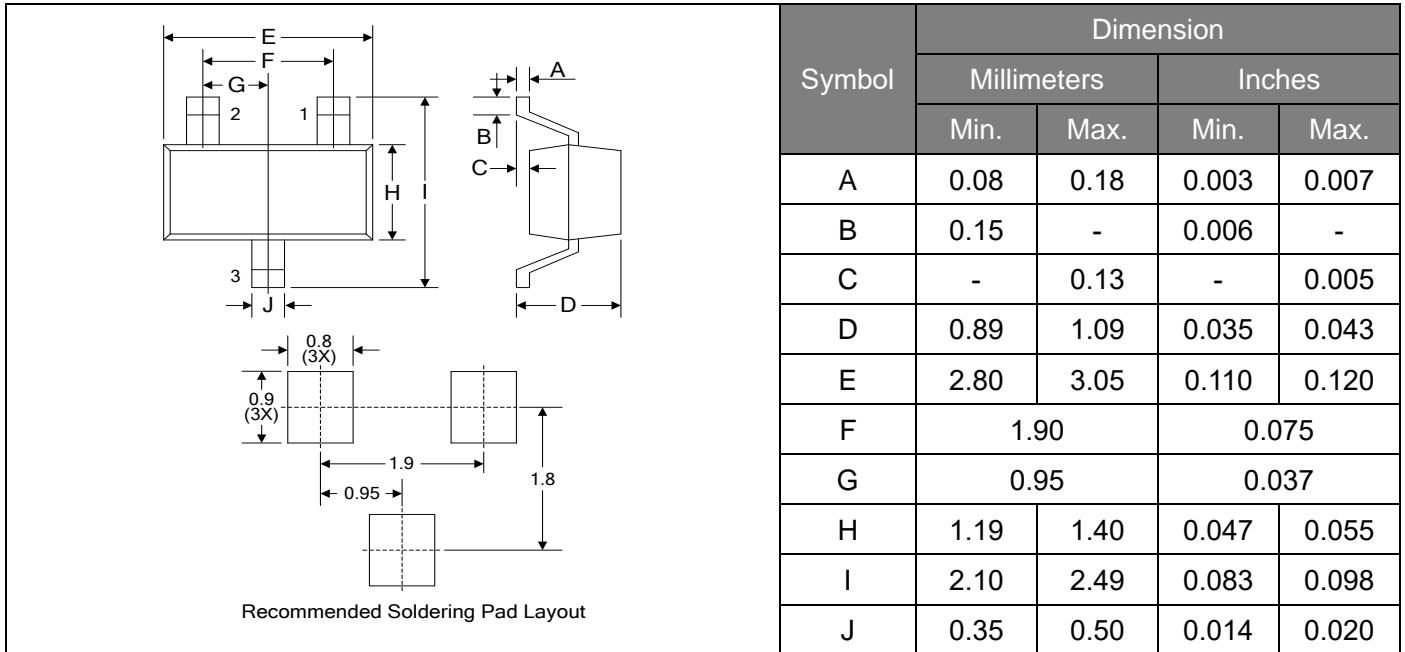

Packaging

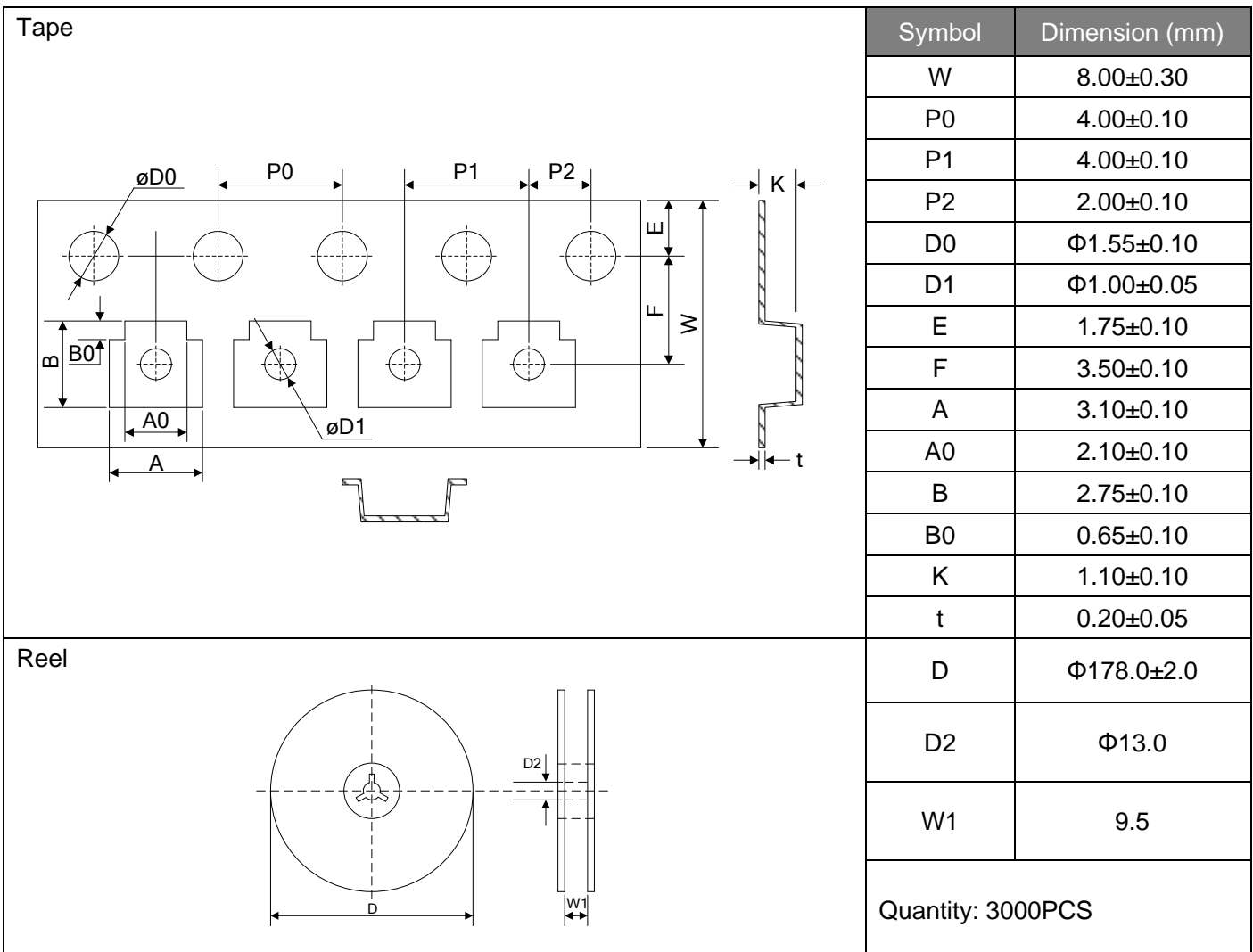

LEGAL DISCLAIMER

YAGEO, its distributors and agents (collectively, "YAGEO"), hereby disclaims any and all liabilities for any errors, inaccuracies or incompleteness contained in any product related information, including but not limited to product specifications, datasheets, pictures and/or graphics. YAGEO may make changes, modifications and/or improvements to product related information at any time and without notice.



YAGEO makes no representation, warranty, and/or guarantee about the fitness of its products for any particular purpose or the continuing production of any of its products. To the maximum extent permitted by law, YAGEO disclaims (i) any and all liability arising out of the application or use of any YAGEO product, (ii) any and all liability, including without limitation special, consequential or incidental damages, and (iii) any and all implied warranties, including warranties of fitness for a particular purpose, non-infringement and merchantability.

YAGEO products are designed for general purpose applications under normal operation and usage conditions. Please contact YAGEO for the applications listed below which require especially high reliability for the prevention of defects which might directly cause damage to the third party's life, body or property: Aerospace equipment (artificial satellite, rocket, etc.), Atomic energy-related equipment, Aviation equipment, Disaster prevention equipment, crime prevention equipment, Electric heating apparatus, burning equipment, Highly public information network equipment, data-processing equipment, Medical devices, Military equipment, Power generation control equipment, Safety equipment, Traffic signal equipment, Transportation equipment and Undersea equipment, or for any other application or use in which the failure of YAGEO products could result in personal injury or death, or serious property damage. Particularly **YAGEO Corporation and its affiliates do not recommend the use of commercial or automotive grade products for high reliability applications or manned space flight.**

Information provided here is intended to indicate product specifications only. YAGEO reserves all the rights for revising this content without further notification, as long as products are unchanged. Any product change will be announced by PCN.

Looking for pricing, stock, or lifecycle information?

Click below to explore more details on WIN SOURCE:

-  [View SDT23C24L02-AT on WIN SOURCE](#)
-  [Yageo Information](#)

Optimize Your Supply Chain with WIN SOURCE Solutions

-  Global Sourcing Solution
-  Obsolete Management
-  Cost Control Management
-  Shortage Management
-  Alternative Solution
-  Excess Inventory Management