



**THE DATASHEET OF
DPX255000DT-5089A1**





May. 2021 Ver.4.0
TDK Corporation

Multilayer Diplexer

DPX Series 2.5x2.0mm [EIA 1008] TYPE

P/N: **DPX255000DT-5089A1**

DPX255000DT-5089A1

SHAPES AND DIMENSIONS

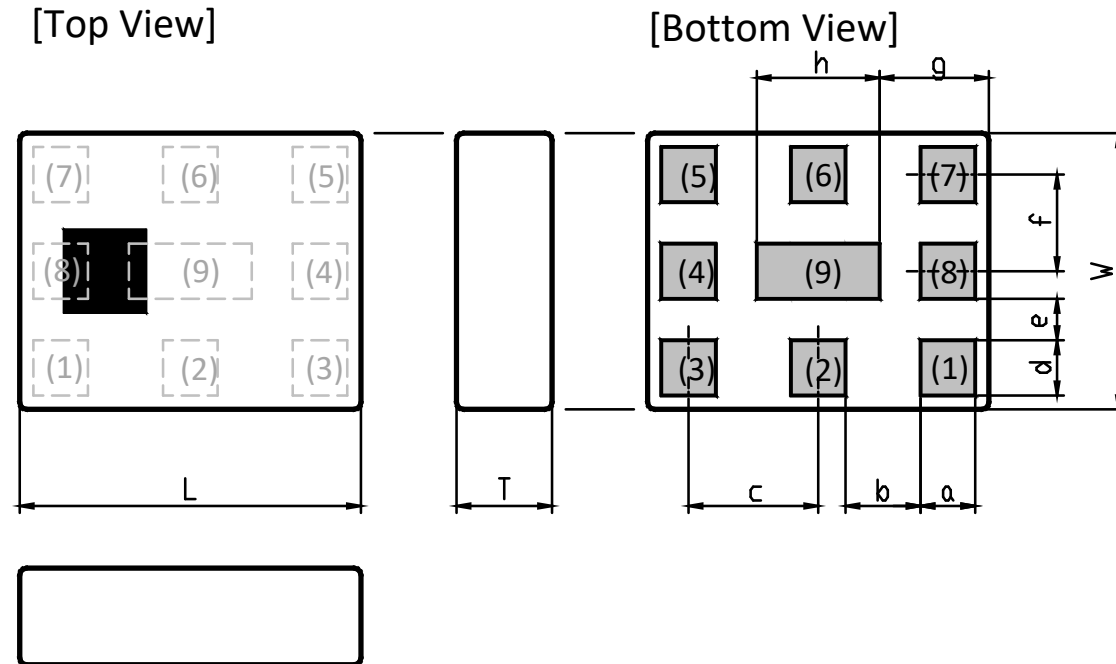

Dimensions (mm)

L	W	T	a	b	c	d	e	f	g	h
2.50	2.00	0.75	0.40	0.55	0.95	0.40	0.30	0.70	0.80	0.90
+/-0.10	+/-0.10	Max	+/-0.10	+/-0.15	+/-0.10	+/-0.10	+/-0.10	+/-0.10	+/-0.10	+/-0.10

Terminal functions

(1)	GND
(2)	Common Port
(3)	GND
(4)	GND
(5)	High-Band Port

(6)	GND
(7)	Low-Band Port
(8)	GND
(9)	GND

TERMINATION FINISH

Material
Ag

DPX255000DT-5089A1

■ ELECTRICAL CHARACTERISTICS

(Measurement)

Low-Band

Parameter	Frequency (MHz)	TDK Spec		
		Min.	Typ.	Max.
Insertion Loss (dB)	1447.9 to 2690	-	0.76	0.95
Insertion Loss (dB) (-40 to +85 °C)	1447.9 to 2690	-		1.10
Return Loss (Low-Band Port)	1447.9 to 2690	10	13.9	-
Attenuation (dB)	0 to 960	22	25.0	-
	1164 to 1189	2	4.1	-
	3300 to 3500	18	26.6	-
	3500 to 6000	23	24.7	-
	6000 to 9000	25	29.9	-
	9000 to 12750	10	13.7	-
Characteristic Impedance (ohm)		50 (Nominal)		

Ta = +25+/-5°C

High-Band

Parameter	Frequency (MHz)	TDK Spec		
		Min.	Typ.	Max.
Insertion Loss (dB)	3300 to 5000	-	0.77	0.97
Insertion Loss (dB) (-40 to +85 °C)	3300 to 5000	-		1.12
Return Loss (High-Band Port)	3300 to 5000	12	16.4	-
Attenuation (dB)	100 to 1000	30	42.0	-
	1164 to 1189	28	32.5	-
	1448 to 2690	20	24.3	-
	5100 to 5150	0.5	0.8	-
	5850 to 5950	13	20.7	-
	5950 to 6000	15	29.2	-
	6000 to 9000	20	24.2	-
	9000 to 12750	11	16.0	-
Characteristic Impedance (ohm)		50 (Nominal)		

Ta = +25+/-5°C

DPX255000DT-5089A1

ELECTRICAL CHARACTERISTICS

(Measurement)

Common

Parameter	Frequency (MHz)	TDK Spec		
		Min.	Typ.	Max.
Isolation (dB)	100 to 2690	20	24.4	-
	3300 to 6000	18	24.5	-
Return Loss (Common Port)	1447.9 to 2690	10	14.3	-
	3300 to 5000	12	15.7	-
Characteristic Impedance (ohm)		50 (Nominal)		

 $T_a = +25\pm 5^\circ\text{C}$

MAXIMUM RATINGS

Parameter		TDK Spec	Conditions
Operating temperature (°C)		-40 to +85 °C	
Storage temperature (°C)		-40 to +85 °C	
Power Handling (W) *1	Frequency (MHz)		
	Low-Band	1447.9 to 2690	1 CW
	High-Band	3300 to 5000	1 CW
Human Body Model : HBM	@Each Port (V)	+/-1000	100pF / 1500ohm
Machine Model : MM	@Each Port (V)	+/-150	200pF / 0ohm
Charged Device Model : CDM	@Each Port (V)	+/-500	Humidity : 60%RH max

*1 : Refer to 3GPP TS 38.101-1 V15.2.0

DPX255000DT-5089A1

FREQUENCY CHARACTERISTICS

Low band-Port S21

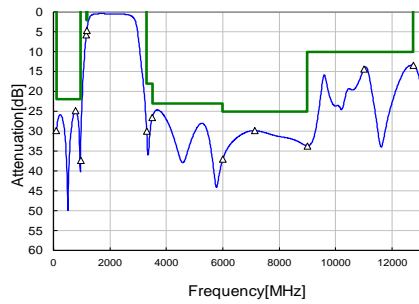

Attenuation	
100 MHz	29.90 dB
780 MHz	24.90 dB
960 MHz	37.28 dB
1164 MHz	5.80 dB
1189 MHz	4.60 dB
3300 MHz	29.96 dB
3500 MHz	26.57 dB
6000 MHz	37.06 dB
7140 MHz	29.86 dB
9000 MHz	33.67 dB
11000 MHz	14.28 dB
12750 MHz	13.44 dB

High band-Port S31

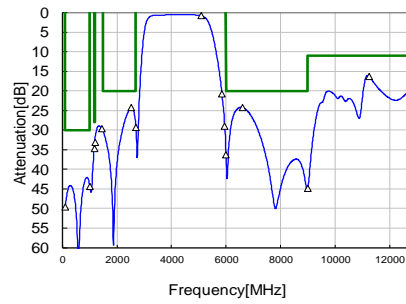

Attenuation	
100 MHz	49.66 dB
1000 MHz	44.34 dB
1164 MHz	34.65 dB
1189 MHz	33.09 dB
1448 MHz	29.65 dB
2510 MHz	24.26 dB
2690 MHz	29.37 dB
5100 MHz	0.83 dB
5850 MHz	20.69 dB
6000 MHz	36.34 dB
6600 MHz	24.25 dB
9000 MHz	44.88 dB
11250 MHz	16.29 dB
12750 MHz	19.88 dB

Low band-Port S21

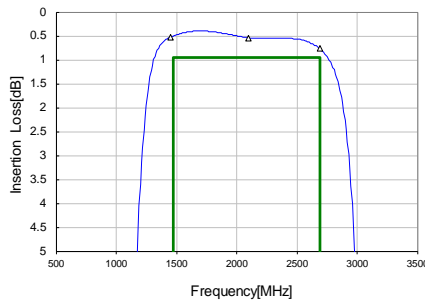

Insertion Loss	
1447.9 MHz	0.53 dB
2100 MHz	0.54 dB
2690 MHz	0.76 dB

High band-Port S31

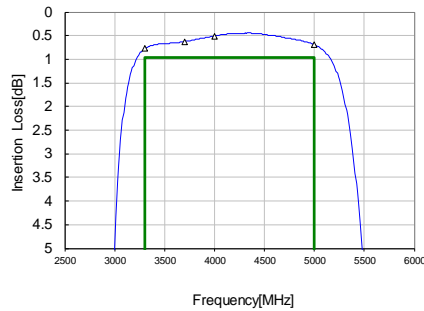

Insertion Loss	
3300 MHz	0.77 dB
3700 MHz	0.62 dB
4000 MHz	0.51 dB
5000 MHz	0.69 dB

Common Port Return Loss S11

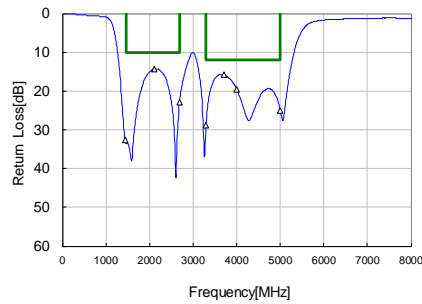

1447.9 MHz	32.72 dB
2100 MHz	14.27 dB
2690 MHz	22.87 dB
3300 MHz	28.71 dB
3700 MHz	15.74 dB
4000 MHz	19.56 dB
5000 MHz	25.02 dB

Isolation S23

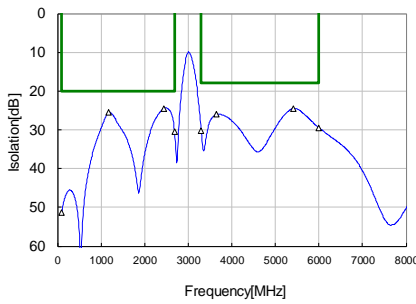

100 MHz	51.3 dB
1180 MHz	25.5 dB
2690 MHz	30.6 dB
3300 MHz	30.2 dB
3650 MHz	26.1 dB
5420 MHz	24.5 dB
6000 MHz	29.5 dB

Low band-Port Return Loss S22

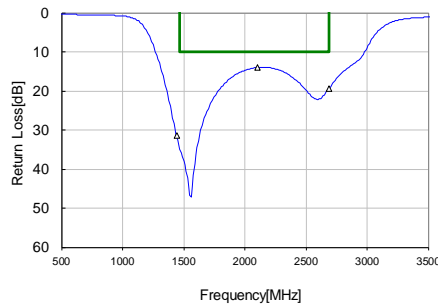

1447.9 MHz	31.34 dB
2100 MHz	14.02 dB
2690 MHz	19.31 dB

High band-Port Return Loss S33

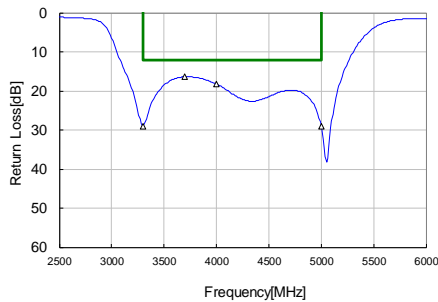

3300 MHz	29.02 dB
3700 MHz	16.37 dB
4000 MHz	18.33 dB
5000 MHz	29.17 dB

All specifications are subject to change without notice.

TDK Technology - Proprietary and Confidential Information of TDK Group Companies

DPX255000DT-5089A1

RECOMMENDED LAND PATTERN

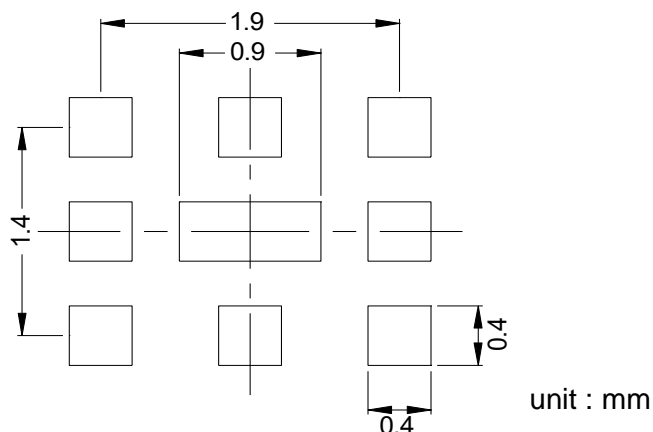

EVALUATION BOARD

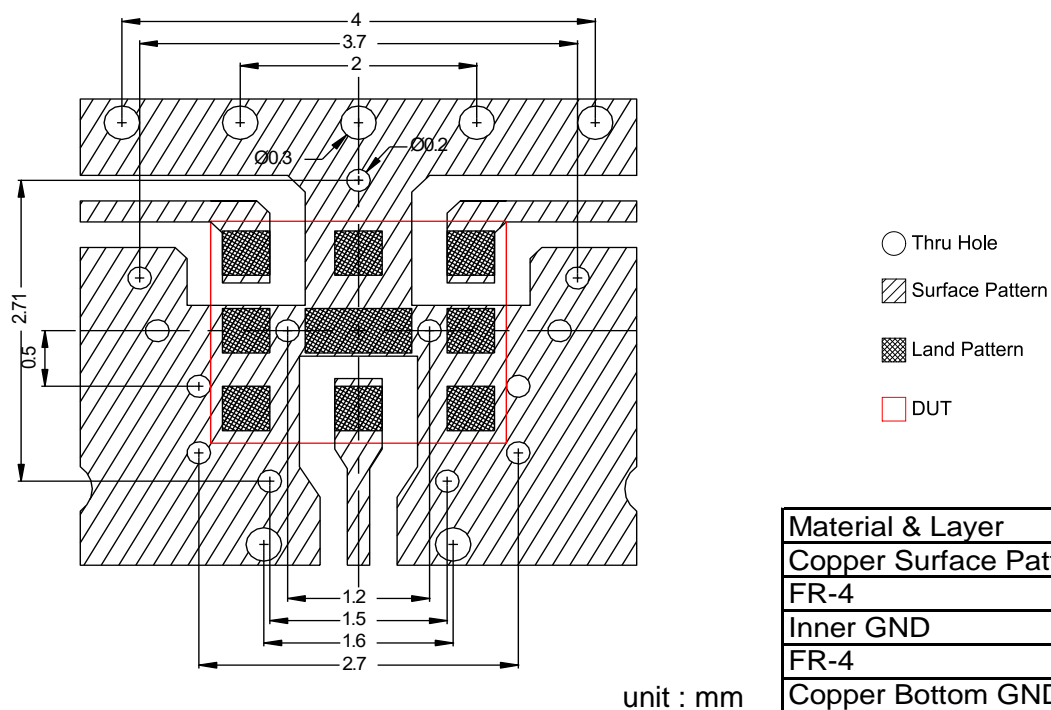

Material & Layer	Thickness
Copper Surface Pattern	0.035 mm
FR-4	0.10 mm
Inner GND	0.018 mm
FR-4	0.30 mm
Copper Bottom GND	0.035 mm

* Line width should be designed to match 50 ohm characteristic impedance depending on PCB material and thickness.

** The position of the through hole which have possibility of influence to the performance are indicated by dimension line.

ENVIRONMENT INFORMATION

RoHS Statement
 RoHS Compliance

DPX255000DT-5089A1

RECOMMENDED REFLOW PROFILE

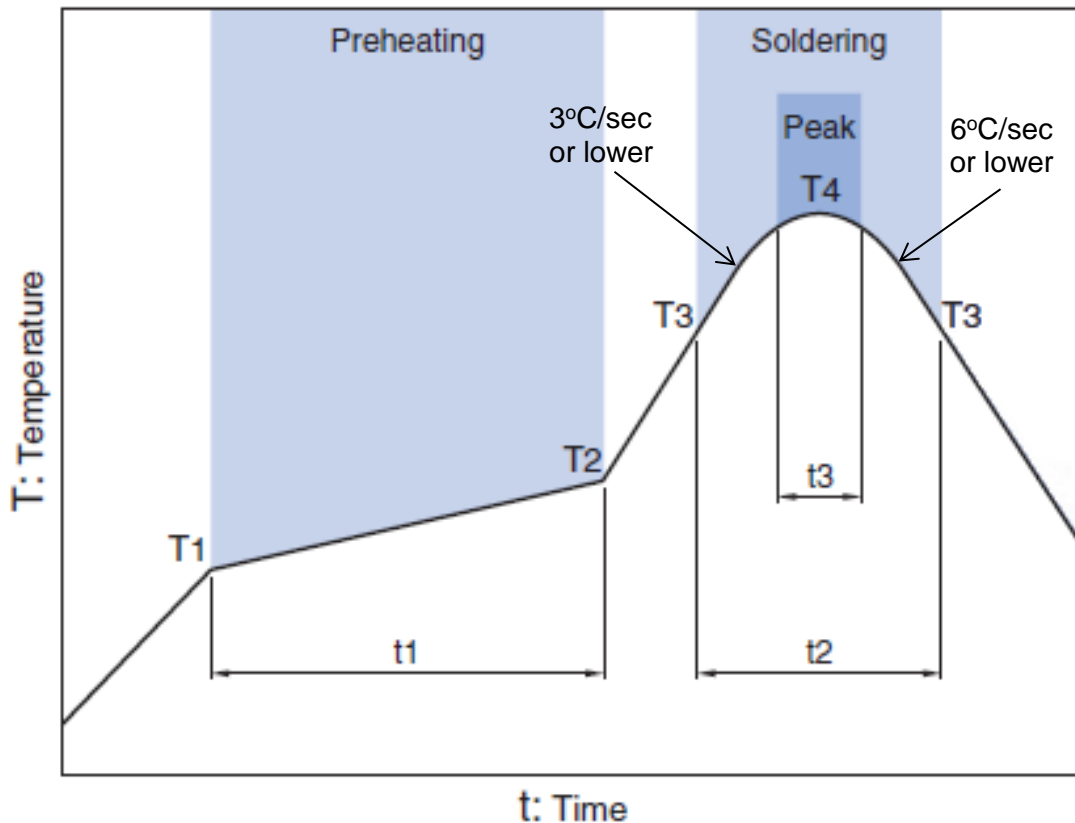

Preheating			Soldering			
			Critical zone (T3 to T4)		Peak	
Temp.		Time	Temp.	Time	Temp.	Time
T1	T2	t1	T3	t2	T4	t3 *
150°C	200°C	60 to 120sec	217°C	60 to 120sec	240 to 260°C	30 sec Max

* t3 : Time within 5°C of actual peak temperature

The maximum number of reflow is 3.

Note: Lead free solder is recommended.
Recommended solder is Sn-3.0Ag-0.5Cu. (M705 by Senju Metal Industry)

DPX255000DT-5089A1**PACKAGING STYLE**

Reel Dimensions

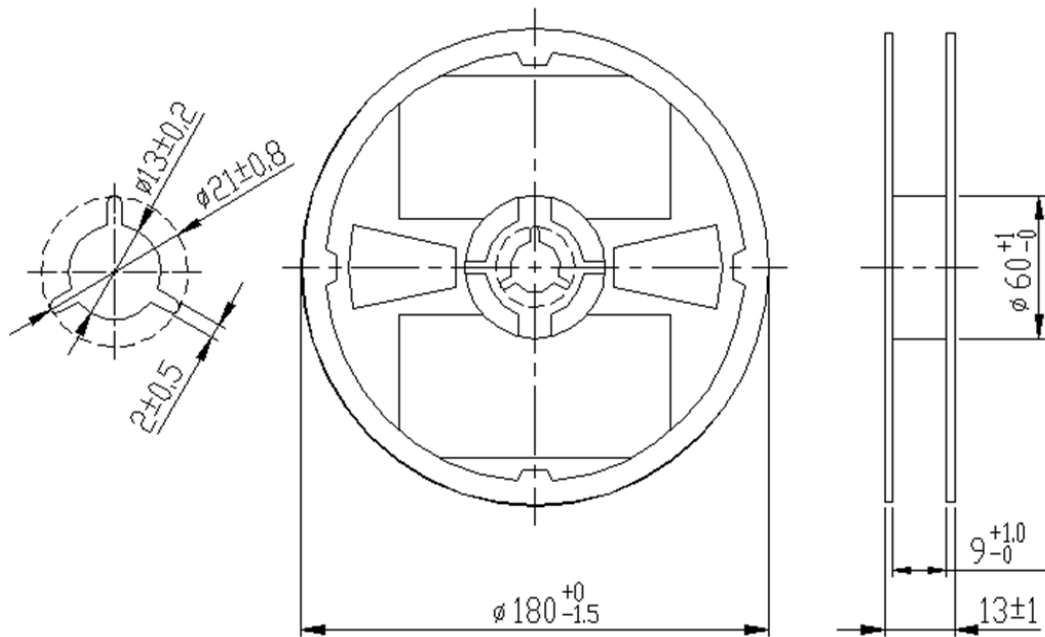

Dimensions in mm

Carrier Tape

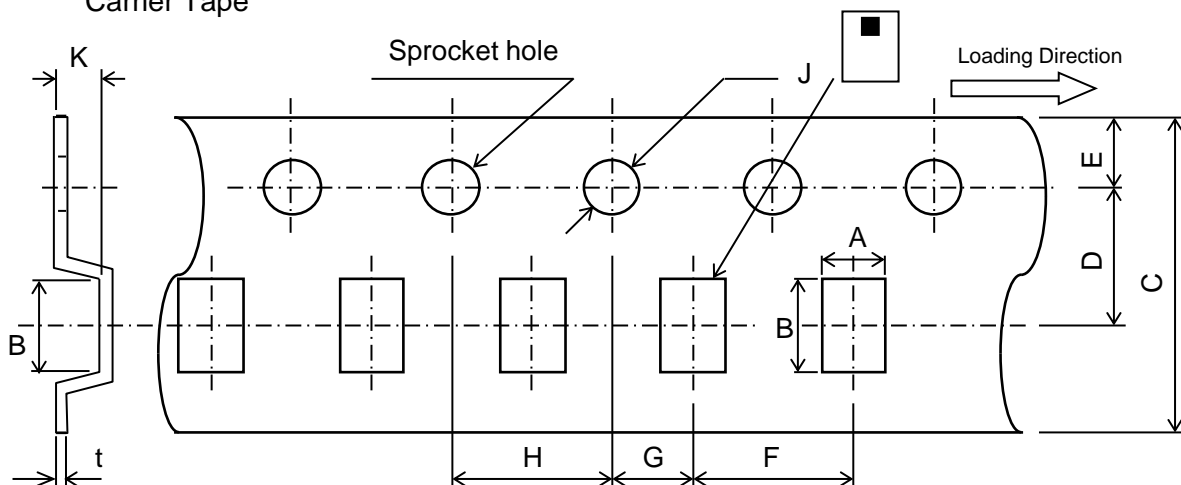

Dimensions (mm)

A	B	C	D	E	F	G	H	J	K	t
2.2	2.7	8.0	3.5	1.75	4.0	2.0	4.0	1.5	0.85	0.25
± 0.05	± 0.05	$+0.3/-0.1$	± 0.05	± 0.1	± 0.1	± 0.05	± 0.1	$+0.1/-0$	MAX	± 0.05

STANDARD PACKAGE QUANTITY
(pieces/reel)

2,000

All specifications are subject to change without notice.

TDK Technology - Proprietary and Confidential Information of TDK Group Companies

REMINDERS FOR USING THESE PRODUCTS

Before using these products, be sure to request the delivery specifications.

SAFETY REMINDERS

Please pay sufficient attention to the warnings for safe designing when using these products.

 REMINDERS
--

The products listed on this specification sheet are intended for use in general electronic equipment (AV equipment, telecommunications equipment, home appliances, amusement equipment, computer equipment, personal equipment, office equipment, measurement equipment, industrial robots) under a normal operation and use condition.



The products are not designed or warranted to meet the requirements of the applications listed below, whose performance and/or quality require a more stringent level of safety or reliability, or whose failure, malfunction or trouble could cause serious damage to society, person or property. Please understand that we are not responsible for any damage or liability caused by use of the products in any of the applications below or for any other use exceeding the range or conditions set forth in this specification sheet.

1. Aerospace/Aviation equipment
2. Transportation equipment (cars, electric trains, ships, etc.)
3. Medical equipment
4. Power-generation control equipment
5. Atomic energy-related equipment
6. Seabed equipment
7. Transportation control equipment
8. Public information-processing equipment
9. Military equipment
10. Electric heating apparatus, burning equipment
11. Disaster prevention/crime prevention equipment
12. Safety equipment
13. Other applications that are not considered general-purpose applications

When using this product in general-purpose applications, you are kindly requested to take into consideration securing protection circuit/equipment or providing backup circuits, etc., to ensure higher safety.

Looking for pricing, stock, or lifecycle information?

Click below to explore more details on WIN SOURCE:

-  [View DPX255000DT-5089A1 on WIN SOURCE](#)
-  [TDK Corporation](#) Information

Optimize Your Supply Chain with WIN SOURCE Solutions

-  Global Sourcing Solution
-  Obsolete Management
-  Cost Control Management
-  Shortage Management
-  Alternative Solution
-  Excess Inventory Management