



**THE DATASHEET OF
LBM2016T680J**



Notice for TAIYO YUDEN products

Please read this notice before using the TAIYO YUDEN products.

⚠️ REMINDERS

■ Product Information in this Catalog

Product information in this catalog is as of January 2021. All of the contents specified herein and production status of the products listed in this catalog are subject to change without notice due to technical improvement of our products, etc. Therefore, please check for the latest information carefully before practical application or use of our products.

Please note that TAIYO YUDEN shall not be in any way responsible for any damages and defects in products or equipment incorporating our products, which are caused under the conditions other than those specified in this catalog or individual product specification sheets.

■ Approval of Product Specifications

Please contact TAIYO YUDEN for further details of product specifications as the individual product specification sheets are available. When using our products, please be sure to approve our product specifications or make a written agreement on the product specification with TAIYO YUDEN in advance.

■ Pre-Evaluation in the Actual Equipment and Conditions

Please conduct validation and verification of our products in actual conditions of mounting and operating environment before using our products.

■ Limited Application

1. Equipment Intended for Use

The products listed in this catalog are intended for general-purpose and standard use in general electronic equipment (e.g., AV equipment, OA equipment, home electric appliances, office equipment, information and communication equipment including, without limitation, mobile phone, and PC) and other equipment specified in this catalog or the individual product specification sheets.

TAIYO YUDEN has the line-up of the products intended for use in automotive electronic equipment, telecommunications infrastructure and industrial equipment, or medical devices classified as GHTF Classes A to C (Japan Classes I to III). Therefore, when using our products for these equipment, please check available applications specified in this catalog or the individual product specification sheets and use the corresponding products.

2. Equipment Requiring Inquiry

Please be sure to contact TAIYO YUDEN for further information before using the products listed in this catalog for the following equipment (excluding intended equipment as specified in this catalog or the individual product specification sheets) which may cause loss of human life, bodily injury, serious property damage and/or serious public impact due to a failure or defect of the products and/or malfunction attributed thereto.

- (1) Transportation equipment (automotive powertrain control system, train control system, and ship control system, etc.)
- (2) Traffic signal equipment
- (3) Disaster prevention equipment, crime prevention equipment
- (4) Medical devices classified as GHTF Class C (Japan Class III)
- (5) Highly public information network equipment, data-processing equipment (telephone exchange, and base station, etc.)
- (6) Any other equipment requiring high levels of quality and/or reliability equal to the equipment listed above

3. Equipment Prohibited for Use

Please do not incorporate our products into the following equipment requiring extremely high levels of safety and/or reliability.

- (1) Aerospace equipment (artificial satellite, rocket, etc.)
- (2) Aviation equipment *¹
- (3) Medical devices classified as GHTF Class D (Japan Class IV), implantable medical devices *²

- (4) Power generation control equipment (nuclear power, hydroelectric power, thermal power plant control system, etc.)
- (5) Undersea equipment (submarine repeating equipment, underwater work equipment, etc.)
- (6) Military equipment
- (7) Any other equipment requiring extremely high levels of safety and/or reliability equal to the equipment listed above

*Notes:

1. There is a possibility that our products can be used only for aviation equipment that does not directly affect the safe operation of aircraft (e.g., in-flight entertainment, cabin light, electric seat, cooking equipment) if such use meets requirements specified separately by TAIYO YUDEN. Please be sure to contact TAIYO YUDEN for further information before using our products for such aviation equipment.
2. Implantable medical devices contain not only internal unit which is implanted in a body, but also external unit which is connected to the internal unit.

4. Limitation of Liability

Please note that unless you obtain prior written consent of TAIYO YUDEN, TAIYO YUDEN shall not be in any way responsible for any damages incurred by you or third parties arising from use of the products listed in this catalog for any equipment that is not intended for use by TAIYO YUDEN, or any equipment requiring inquiry to TAIYO YUDEN or prohibited for use by TAIYO YUDEN as described above.

■ Safety Design

When using our products for high safety and/or reliability-required equipment or circuits, please fully perform safety and/or reliability evaluation. In addition, please install (i) systems equipped with a protection circuit and a protection device and/or (ii) systems equipped with a redundant circuit or other system to prevent an unsafe status in the event of a single fault for a failsafe design to ensure safety.

■ Intellectual Property Rights

Information contained in this catalog is intended to convey examples of typical performances and/or applications of our products and is not intended to make any warranty with respect to the intellectual property rights or any other related rights of TAIYO YUDEN or any third parties nor grant any license under such rights.

■ Limited Warranty

Please note that the scope of warranty for our products is limited to the delivered our products themselves and TAIYO YUDEN shall not be in any way responsible for any damages resulting from a failure or defect in our products. Notwithstanding the foregoing, if there is a written agreement (e.g., supply and purchase agreement, quality assurance agreement) signed by TAIYO YUDEN and your company, TAIYO YUDEN will warrant our products in accordance with such agreement.

■ TAIYO YUDEN's Official Sales Channel

The contents of this catalog are applicable to our products which are purchased from our sales offices or authorized distributors (hereinafter "TAIYO YUDEN's official sales channel"). Please note that the contents of this catalog are not applicable to our products purchased from any seller other than TAIYO YUDEN's official sales channel.

■ Caution for Export

Some of our products listed in this catalog may require specific procedures for export according to "U.S. Export Administration Regulations", "Foreign Exchange and Foreign Trade Control Law" of Japan, and other applicable regulations. Should you have any questions on this matter, please contact our sales staff.

▶ This catalog contains the typical specification only due to the limitation of space. When you consider the purchase of our products, please check our product specification sheets. For details of each product (characteristics graph, reliability information, precautions for use, and so on), see our website (<http://www.ty-top.com/>).

WIRE-WOUND CHIP INDUCTORS FOR SIGNAL LINES (LB SERIES M TYPE)

REFLOW

■ PARTS NUMBER

* Operating Temp.: -40~+105°C (Including self-generated heat)

| | | | | | | | | | | | | | |
|---|---|---|---|---|---|---|---|---|---|---|---|---|---|
| L | B | M | △ | 2 | 0 | 1 | 6 | T | 1 | 0 | 0 | J | △ |
| ① | | | | ② | | | | ③ | | | | ⑤ | ⑥ |

△=Blank space

① Series name

| Code | Series name |
|------|-------------------------------------|
| LBM△ | Wound chip inductor for signal line |

② Dimensions (L×W)

| Code | Type (inch) | Dimensions (L×W) [mm] |
|------|-------------|-----------------------|
| 2016 | 2016(0806) | 2.0×1.6 |

③ Packaging

| Code | Packaging |
|------|-----------|
| T | Taping |

④ Nominal inductance

| Code (example) | Nominal inductance [μH] |
|----------------|-------------------------|
| R12 | 0.12 |
| 1R0 | 1.0 |
| 100 | 10 |
| 101 | 100 |

※R=Decimal point

⑤ Inductance tolerance

| Code | Inductance tolerance |
|------|----------------------|
| J | ±5% |

⑥ Internal code

■ STANDARD EXTERNAL DIMENSIONS / STANDARD QUANTITY

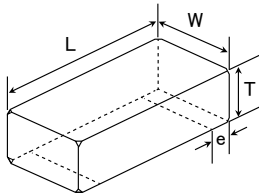

Recommended Land Patterns

Surface Mounting

- Mounting and soldering conditions should be checked beforehand.
- Applicable soldering process to these products is reflow soldering only.

| Type | A | B | C |
|----------|-----|-----|-----|
| LBM 2016 | 0.6 | 1.0 | 1.8 |

Unit: mm

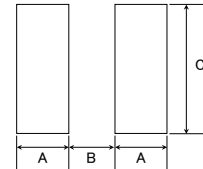

| Type | L | W | T | e | Standard quantity [pcs] | |
|----------|-------------------------|--------------------------|--------------------------|-------------------------|-------------------------|---------------|
| | | | | | Paper tape | Embossed tape |
| LBM 2016 | 2.0±0.2 (0.08±0.008) | 1.6±0.2 (0.063±0.008) | 1.6±0.2 (0.063±0.008) | 0.5±0.2 (0.02±0.008) | — | 2000 |

Unit: mm (inch)

► This catalog contains the typical specification only due to the limitation of space. When you consider the purchase of our products, please check our product specification sheets. For details of each product (characteristics graph, reliability information, precautions for use, and so on), see our website (<http://www.ty-top.com/>).

■ PARTS NUMBER

● LBM2016 (0806) type

| Parts number | EHS | Nominal inductance [μ H] | Inductance tolerance | Q (min.) | Self-resonant frequency [MHz] (min.) | DC Resistance [Ω] ($\pm 30\%$) | Rated current [mA] (max.) | Measuring frequency [MHz] |
|---------------|------|----------------------------------|----------------------|-------------|--|--|------------------------------|---------------------------------|
| LBM 2016TR12J | RoHS | 0.12 | $\pm 5\%$ | 30 | 600 | 0.13 | 610 | 25.2 |
| LBM 2016TR15J | RoHS | 0.15 | $\pm 5\%$ | 30 | 550 | 0.15 | 570 | 25.2 |
| LBM 2016TR18J | RoHS | 0.18 | $\pm 5\%$ | 30 | 500 | 0.15 | 560 | 25.2 |
| LBM 2016TR22J | RoHS | 0.22 | $\pm 5\%$ | 30 | 450 | 0.20 | 520 | 25.2 |
| LBM 2016TR27J | RoHS | 0.27 | $\pm 5\%$ | 30 | 425 | 0.21 | 510 | 25.2 |
| LBM 2016TR33J | RoHS | 0.33 | $\pm 5\%$ | 30 | 400 | 0.21 | 490 | 25.2 |
| LBM 2016TR39J | RoHS | 0.39 | $\pm 5\%$ | 30 | 375 | 0.26 | 440 | 25.2 |
| LBM 2016TR47J | RoHS | 0.47 | $\pm 5\%$ | 30 | 350 | 0.26 | 430 | 25.2 |
| LBM 2016TR56J | RoHS | 0.56 | $\pm 5\%$ | 30 | 300 | 0.29 | 410 | 25.2 |
| LBM 2016TR68J | RoHS | 0.68 | $\pm 5\%$ | 30 | 270 | 0.32 | 400 | 25.2 |
| LBM 2016TR82J | RoHS | 0.82 | $\pm 5\%$ | 30 | 250 | 0.34 | 390 | 25.2 |
| LBM 2016T1R0J | RoHS | 1.0 | $\pm 5\%$ | 30 | 220 | 0.38 | 385 | 7.96 |
| LBM 2016T1R2J | RoHS | 1.2 | $\pm 5\%$ | 30 | 180 | 0.41 | 370 | 7.96 |
| LBM 2016T1R5J | RoHS | 1.5 | $\pm 5\%$ | 30 | 135 | 0.47 | 350 | 7.96 |
| LBM 2016T1R8J | RoHS | 1.8 | $\pm 5\%$ | 30 | 100 | 0.48 | 345 | 7.96 |
| LBM 2016T2R2J | RoHS | 2.2 | $\pm 5\%$ | 30 | 75 | 0.54 | 340 | 7.96 |
| LBM 2016T2R7J | RoHS | 2.7 | $\pm 5\%$ | 30 | 55 | 0.59 | 310 | 7.96 |
| LBM 2016T3R3J | RoHS | 3.3 | $\pm 5\%$ | 30 | 48 | 0.68 | 290 | 7.96 |
| LBM 2016T3R9J | RoHS | 3.9 | $\pm 5\%$ | 30 | 43 | 0.74 | 275 | 7.96 |
| LBM 2016T4R7J | RoHS | 4.7 | $\pm 5\%$ | 30 | 40 | 0.78 | 270 | 7.96 |
| LBM 2016T5R6J | RoHS | 5.6 | $\pm 5\%$ | 25 | 36 | 0.88 | 255 | 7.96 |
| LBM 2016T6R8J | RoHS | 6.8 | $\pm 5\%$ | 25 | 33 | 0.97 | 240 | 7.96 |
| LBM 2016T8R2J | RoHS | 8.2 | $\pm 5\%$ | 25 | 30 | 1.1 | 225 | 7.96 |
| LBM 2016T100J | RoHS | 10 | $\pm 5\%$ | 25 | 27 | 1.2 | 215 | 2.52 |
| LBM 2016T120J | RoHS | 12 | $\pm 5\%$ | 25 | 23 | 1.4 | 200 | 2.52 |
| LBM 2016T150J | RoHS | 15 | $\pm 5\%$ | 25 | 20 | 1.5 | 190 | 2.52 |
| LBM 2016T180J | RoHS | 18 | $\pm 5\%$ | 25 | 18 | 2.5 | 150 | 2.52 |
| LBM 2016T220J | RoHS | 22 | $\pm 5\%$ | 25 | 17 | 2.8 | 140 | 2.52 |
| LBM 2016T270J | RoHS | 27 | $\pm 5\%$ | 25 | 16 | 3.2 | 130 | 2.52 |
| LBM 2016T330J | RoHS | 33 | $\pm 5\%$ | 25 | 15 | 3.6 | 125 | 2.52 |
| LBM 2016T390J | RoHS | 39 | $\pm 5\%$ | 20 | 14 | 3.9 | 120 | 2.52 |
| LBM 2016T470J | RoHS | 47 | $\pm 5\%$ | 20 | 13 | 4.1 | 115 | 2.52 |
| LBM 2016T560J | RoHS | 56 | $\pm 5\%$ | 20 | 12 | 5.9 | 95 | 2.52 |
| LBM 2016T680J | RoHS | 68 | $\pm 5\%$ | 20 | 11 | 7.0 | 90 | 2.52 |
| LBM 2016T820J | RoHS | 82 | $\pm 5\%$ | 20 | 10 | 7.7 | 85 | 2.52 |
| LBM 2016T101J | RoHS | 100 | $\pm 5\%$ | 15 | 9.0 | 8.0 | 80 | 0.796 |
| LBM 2016T151J | RoHS | 150 | $\pm 5\%$ | 15 | 6.5 | 13.5 | 69 | 0.796 |
| LBM 2016T181J | RoHS | 180 | $\pm 5\%$ | 15 | 6.0 | 15 | 67 | 0.796 |
| LBM 2016T221J | RoHS | 220 | $\pm 5\%$ | 15 | 5.5 | 18 | 65 | 0.796 |

※) Rated Current : The maximum DC value having inductance decrease within 10 % and temperature increase within 20 degC by the application of DC bias.

▶ This catalog contains the typical specification only due to the limitation of space. When you consider the purchase of our products, please check our product specification sheets. For details of each product (characteristics graph, reliability information, precautions for use, and so on), see our website (<http://www.ty-top.com/>).

WIRE-WOUND CHIP INDUCTORS (LB SERIES), WIRE-WOUND CHIP POWER INDUCTORS (CB SERIES), WIRE-WOUND CHIP INDUCTORS FOR SIGNAL LINES (LB SERIES M TYPE)

PACKAGING

① Minimum Quantity

| Type | Standard Quantity [pcs] | |
|----------|-------------------------|---------------|
| | Paper Tape | Embossed Tape |
| LB C3225 | — | 1000 |
| CB C3225 | — | 1000 |
| LB 3218 | — | 2000 |
| LB R2518 | — | 2000 |
| LB C2518 | — | 2000 |
| LB 2518 | — | 2000 |
| CB 2518 | — | 2000 |
| CB C2518 | — | 2000 |
| LBM2016 | — | 2000 |
| LB C2016 | — | 2000 |
| LB 2016 | — | 2000 |
| CB 2016 | — | 2000 |
| CB C2016 | — | 2000 |
| LB 2012 | — | 3000 |
| LB C2012 | — | 3000 |
| LB R2012 | — | 3000 |
| CB 2012 | — | 3000 |
| CB C2012 | — | 3000 |
| CB L2012 | 4000 | — |
| LB 1608 | 4000 | — |
| LBMF1608 | — | 3000 |
| CBMF1608 | — | 3000 |

② Tape material

● Embossed tape

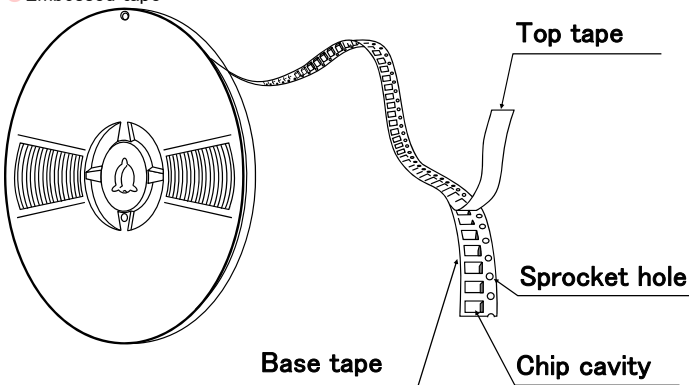

● Card board carrier tape

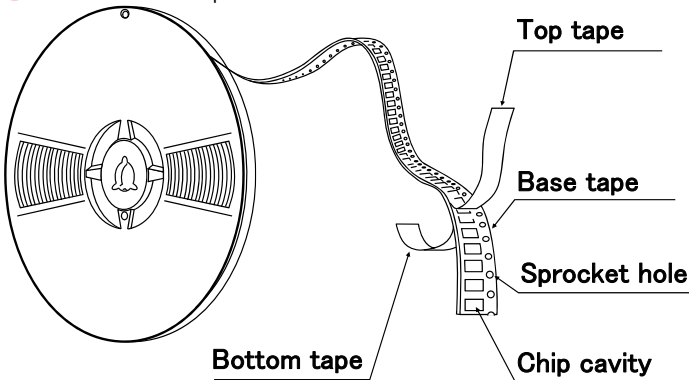

▶ This catalog contains the typical specification only due to the limitation of space. When you consider the purchase of our products, please check our specification. For details of each product (characteristics graph, reliability information, precautions for use, and so on), see our Web site (<http://www.ty-top.com/>).

③ Taping Dimensions

● Embossed Tape (0.315 inches wide)

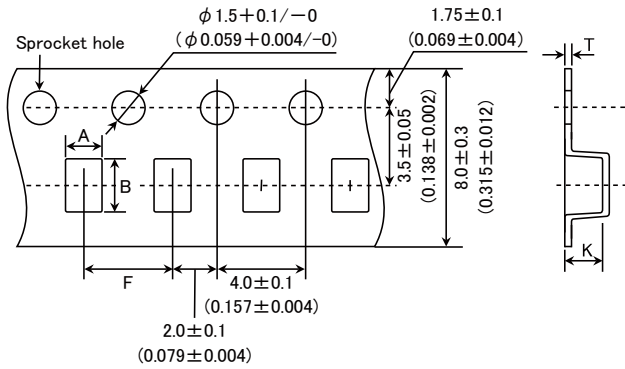

| Type | Chip cavity | | Insertion pitch | Tape thickness | |
|--|---|---|--|--|-------------------------|
| | A | B | F | T | K |
| LBM2016 | 1.75 ± 0.1 (0.069 ± 0.004) | 2.1 ± 0.1 (0.083 ± 0.004) | 4.0 ± 0.1 (0.157 ± 0.004) | 0.3 ± 0.05 (0.012 ± 0.002) | 1.9max. (0.075max.) |
| LB C3225 CB C3225 | 2.8 ± 0.1 (0.110 ± 0.004) | 3.5 ± 0.1 (0.138 ± 0.004) | 4.0 ± 0.1 (0.157 ± 0.004) | 0.3 ± 0.05 (0.012 ± 0.002) | 4.0max. (0.157max.) |
| LB 3218 | 2.1 ± 0.1 (0.083 ± 0.004) | 3.5 ± 0.1 (0.138 ± 0.004) | 4.0 ± 0.1 (0.157 ± 0.004) | 0.3 ± 0.05 (0.012 ± 0.002) | 2.2max. (0.087max.) |
| LB 2518 CB 2518 LB C2518 CB C2518 LB R2518 | 2.15 ± 0.1 (0.085 ± 0.004) | 2.7 ± 0.1 (0.106 ± 0.004) | 4.0 ± 0.1 (0.157 ± 0.004) | 0.3 ± 0.05 (0.012 ± 0.002) | 2.2max. (0.087max.) |
| LB 2016 CB 2016 LB C2016 CB C2016 | 1.75 ± 0.1 (0.069 ± 0.004) | 2.1 ± 0.1 (0.083 ± 0.004) | 4.0 ± 0.1 (0.157 ± 0.004) | 0.3 ± 0.05 (0.012 ± 0.002) | 1.9max. (0.075max.) |
| LB 2012 CB 2012 LB C2012 CB C2012 LB R2012 | 1.45 ± 0.1 (0.057 ± 0.004) | 2.25 ± 0.1 (0.089 ± 0.004) | 4.0 ± 0.1 (0.157 ± 0.004) | 0.25 ± 0.05 (0.010 ± 0.002) | 1.45max. (0.057max.) |
| LBMF1608 CBMF1608 | 1.1 ± 0.1 (0.043 ± 0.004) | 1.9 ± 0.1 (0.075 ± 0.004) | 4.0 ± 0.1 (0.157 ± 0.004) | 0.25 ± 0.05 (0.010 ± 0.002) | 1.2max. (0.047max.) |

Unit: mm (inch)

● Card board carrier tape (0.315 inches wide)

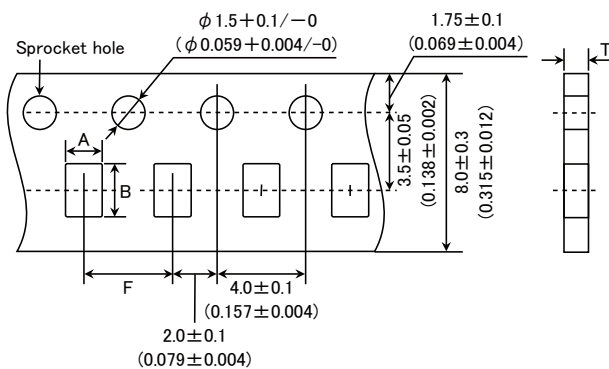

| Type | Chip cavity | | Insertion pitch | Tape thickness |
|----------|---|--|--|------------------------|
| | A | B | F | T |
| CB L2012 | 1.55 ± 0.1 (0.061 ± 0.004) | 2.3 ± 0.1 (0.091 ± 0.004) | 4.0 ± 0.1 (0.157 ± 0.004) | 1.1max. (0.043max.) |
| LB 1608 | 1.0 ± 0.1 (0.039 ± 0.004) | 1.8 ± 0.1 (0.071 ± 0.004) | 4.0 ± 0.1 (0.157 ± 0.004) | 1.1max. (0.043max.) |

Unit: mm (inch)

④ Leader and Blank Portion

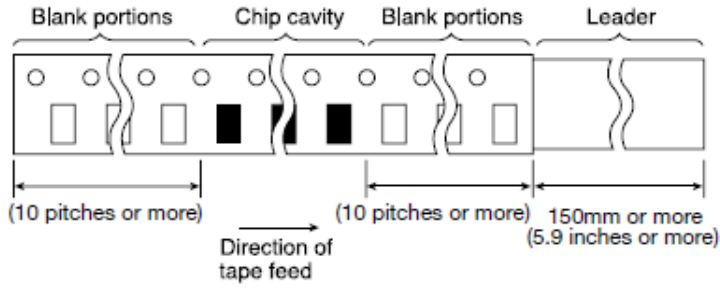

⑤ Reel Size

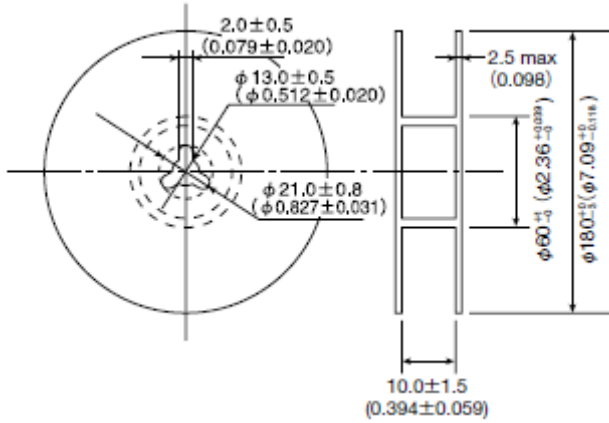

⑥ Top Tape Strength

The top tape requires a peel-off force 0.2 to 0.7N in the direction of the arrow as illustrated below.

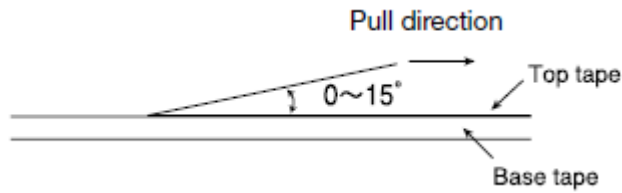

WIRE-WOUND CHIP INDUCTORS (LB SERIES), WIRE-WOUND CHIP POWER INDUCTORS (CB SERIES), WIRE-WOUND CHIP INDUCTORS FOR SIGNAL LINES (LB SERIES M TYPE)

RELIABILITY DATA

| 1. Operating temperature Range | | |
|--|--|---|
| Specified Value | LB, LBC, LBR, LBMF Series | -40~ +105°C (Including self-generated heat) |
| | CB, CBC, CBL, CBMF Series | |
| | LBM Series | |
| 2. Storage Temperature Range (after soldering) | | |
| Specified Value | LB, LBC, LBR, LBMF Series | -40~ +85°C |
| | CB, CBC, CBL, CBMF Series | |
| | LBM Series | |
| Test Methods and Remarks | LB, CB Series : Please refer the term of "7. storage conditions" in precautions. | |
| 3. Rated Current | | |
| Specified Value | LB, LBC, LBR, LBMF Series | Within the specified tolerance |
| | CB, CBC, CBL, CBMF Series | |
| | LBM Series | |
| 4. Inductance | | |
| Specified Value | LB, LBC, LBR, LBMF Series | Within the specified tolerance |
| | CB, CBC, CBL, CBMF Series | |
| | LBM Series | |
| Test Methods and Remarks | LB・LBC・LBR・CB・CBC・CBL・LBMF・CBMF・LBM Series Measuring equipment : LCR Meter (HP4285A or its equivalent) Measuring frequency : Specified frequency | |
| 5. Q | | |
| Specified Value | LB, LBC, LBR, LBMF Series | - |
| | CB, CBC, CBL, CBMF Series | |
| | LBM Series | |
| Test Methods and Remarks | LBM Series Measuring equipment : LCR Meter (HP4285A or its equivalent) Measuring frequency : Specified frequency | |
| 6. DC Resitance | | |
| Specified Value | LB, LBC, LBR, LBMF Series | Within the specified tolerance |
| | CB, CBC, CBL, CBMF Series | |
| | LBM Series | |
| Test Methods and Remarks | Measuring equipment : DC Ohmmeter (HIOKI 3227 or its equivalent) | |
| 7. Self-Resonant Frequency | | |
| Specified Value | LB, LBC, LBR, LBMF Series | Within the specified tolerance |
| | CB, CBC, CBL, CBMF Series | |
| | LBM Series | |
| Test Methods and Remarks | Measuring equipment : Impedance analyzer (HP4291A or its equivalent) | |

▶ This catalog contains the typical specification only due to the limitation of space. When you consider the purchase of our products, please check our specification.
For details of each product (characteristics graph, reliability information, precautions for use, and so on), see our Web site (<http://www.ty-top.com/>).

| 8. Temperature Characteristic | | | | | |
|-------------------------------|---|----------|---------|---------|---------------------------------------|
| Specified Value | LBM2016 | | | | Inductance change : Within $\pm 5\%$ |
| | LB1608 | LB2012 | LBR2012 | CB2012 | Inductance change : Within $\pm 20\%$ |
| | CBL2012 | LB2016 | CB2016 | LB2518 | |
| | LBR2518 | CB2518 | LBC3225 | CBC3225 | |
| | LBMF1608 | CBMF1608 | LBC2016 | CBC2016 | Inductance change : Within $\pm 25\%$ |
| LBC2518 | CBC2518 | LB3218 | | | |
| Test Methods and Remarks | LBC2012 | CBC2012 | | | Inductance change : Within $\pm 35\%$ |
| | Based on the inductance at 20°C and Measured at the ambient of $-40^{\circ}\text{C} \sim +85^{\circ}\text{C}$. | | | | |

| 9. Resistance to Flexure of Substrate | | | |
|---------------------------------------|--|--|------------|
| Specified Value | LB, LBC, LBR, LBMF Series | | No damage. |
| | CB, CBC, CBL, CBMF Series | | |
| | LBM Series | | |
| Test Methods and Remarks | Warp : 2mm (LB·LBC·LBR·CB·CBC·CBL·LBM·LBMF·CBMF Series) | | |
| | Test substrate : Glass epoxy-resin substrate Thickness : 0.8mm (LB1608·LBMF1608·CBMF1608) : 1.0mm (Others) | | |
| | | | |

| 10. Body Strength | | | |
|--------------------------|---|--|------------|
| Specified Value | LB, LBC, LBR, LBMF Series | | No damage. |
| | CB, CBC, CBL, CBMF Series | | |
| | LBM Series | | |
| Test Methods and Remarks | LB·LBC·LBR·CB·CBC·CBL·LBM | | |
| | Applied force : 10N Duration : 10sec. LB1608·LBMF1608·CBMF1608 Applied force : 5N Duration : 10sec. | | |

| 11. Adhesion of terminal electrode | | | |
|------------------------------------|---|--|-----------------|
| Specified Value | LB, LBC, LBR, LBMF Series | | No abnormality. |
| | CB, CBC, CBL, CBMF Series | | |
| | LBM Series | | |
| Test Methods and Remarks | LB·LBC·LBR·CB·CBC·CBL·LBM·LBMF·CBMF | | |
| | Applied force : 10N to X and Y directions Duration : 5 sec. Test substrate : Printed board LB1608·CBMF1608·LBMF1608 Applied force : 5N to X and Y directions Duration : 5 sec. Test substrate : Printed board | | |

▶ This catalog contains the typical specification only due to the limitation of space. When you consider the purchase of our products, please check our specification.
 For details of each product (characteristics graph, reliability information, precautions for use, and so on), see our Web site (<http://www.ty-top.com/>).

| 12. Resistance to vibration | | |
|---|--|--|
| Specified Value | LB, LBC, LBR, LBMF Series | Inductance change : Within $\pm 10\%$ No significant abnormality in appearance. |
| | CB, CBC, CBL, CBMF Series | |
| | LBM Series | Inductance change : Within $\pm 5\%$ No significant abnormality in appearance. |
| Test Methods and Remarks | LB·LBR·LBC·CB·CBC·CBL·LBM·LBMF·CBMF : The given sample is soldered to the board and then it is tested depending on the conditions of the following table. | |
| | Vibration Frequency | 10~55Hz |
| | Total Amplitude | 1.5mm (May not exceed acceleration 196m/s ²) |
| | Sweeping Method | 10Hz to 55Hz to 10Hz for 1min. |
| Time | X | For 2 hours on each X, Y, and Z axis. |
| | Y | |
| | Z | |
| Recovery : At least 2 hrs of recovery under the standard condition after the test, followed by the measurement within 48 hrs. | | |

| 13. Drop test | | |
|-----------------|---------------------------|---|
| Specified Value | LB, LBC, LBR, LBMF Series | — |
| | CB, CBC, CBL, CBMF Series | |
| | LBM Series | |

| 14. Solderability | | |
|--------------------------|---|---|
| Specified Value | LB, LBC, LBR, LBMF Series | At least 90% of surface of terminal electrode is covered by new |
| | CB, CBC, CBL, CBMF Series | |
| | LBM Series | |
| Test Methods and Remarks | LB·LBC·LBR·CB·CBC·CBL·LBM·LBMF·CBMF : Solder temperature : 245 \pm 5 $^{\circ}$ C Duration : 5 \pm 0.5sec Flux : Methanol solution with 25% of colophony | |

| 15. Resistance to soldering | | |
|-----------------------------|---|---------------------------------------|
| Specified Value | LB, LBC, LBR, LBMF Series | Inductance change : Within $\pm 10\%$ |
| | CB, CBC, CBL, CBMF Series | |
| | LBM Series | Inductance change : Within $\pm 5\%$ |
| Test Methods and Remarks | LB·LBC·LBR·CB·CBC·CBL·LBM·LBMF·CBMF : 3 times of reflow oven at 230 $^{\circ}$ C MIN for 40sec. with peak temperature at 260 $^{\circ}$ C for 5sec. Recovery : At least 2 hrs of recovery under the standard condition after the test, followed by the measurement within 48 hrs. | |

| 16. Resistance to solvent | | |
|---------------------------|---|---|
| Specified Value | LB, LBC, LBR, LBMF Series | — |
| | CB, CBC, CBL, CBMF Series | |
| | LBM Series | |
| Test Methods and Remarks | Solvent temperature : Room temperature Type of solvent : Isopropyl alcohol Cleaning conditions : 90s. Immersion and cleaning. | |

| 17. Thermal shock | | | |
|---|---|--|----------------|
| Specified Value | LB, LBC, LBR, LBMF Series | Inductance change : Within $\pm 10\%$ No significant abnormality in appearance. | |
| | CB, CBC, CBL, CBMF Series | | |
| | LBM Series | | |
| Test Methods and Remarks | LB·LBC·LBR·CB·CBC·CBL·LBM·LBMF·CBMF : The given sample is soldered to the board and then its Inductance is measured after 100cycles of the following conditions. | | |
| | Conditions of 1 cycle | | |
| | Step | Temperature ($^{\circ}$ C) | Duration (min) |
| | 1 | -40 \pm 3 | 30 \pm 3 |
| | 2 | Room temperature | Within 3 |
| | 3 | +85 \pm 2 | 30 \pm 3 |
| 4 | Room temperature | Within 3 | |
| Recovery : At least 2 hrs of recovery under the standard condition after the test, followed by the measurement within 48 hrs. | | | |

▶ This catalog contains the typical specification only due to the limitation of space. When you consider the purchase of our products, please check our specification.
For details of each product (characteristics graph, reliability information, precautions for use, and so on), see our Web site (<http://www.ty-top.com/>).

| 18.Damp heat life test | | |
|--------------------------|---|--|
| Specified Value | LB, LBC, LBR, LBMF Series | Inductance change : Within $\pm 10\%$ No significant abnormality in appearance. |
| | CB, CBC, CBL, CBMF Series | |
| | LBM Series | |
| Test Methods and Remarks | Temperature : $60 \pm 2^\circ\text{C}$ Humidity : $90 \sim 95\% \text{RH}$ Duration : 1000 hrs Recovery : At least 2 hrs of recovery under the standard condition after the test, followed by the measurement within 48 hrs. | |

| 19.Loading under damp heat life test | | |
|--------------------------------------|--|--|
| Specified Value | LB, LBC, LBR, LBMF Series | Inductance change : Within $\pm 10\%$ No significant abnormality in appearance. |
| | CB, CBC, CBL, CBMF Series | |
| | LBM Series | |
| Test Methods and Remarks | Temperature : $60 \pm 2^\circ\text{C}$ Humidity : $90 \sim 95\% \text{RH}$ Duration : 1000 hrs Applied current : Rated current Recovery : At least 2 hrs of recovery under the standard condition after the test, followed by the measurement within 48 hrs. | |

| 20.High temperature life test | | |
|-------------------------------|--|--|
| Specified Value | LB, LBC, LBR, LBMF Series | — |
| | CB, CBC, CBL, CBMF Series | Inductance change : Within $\pm 10\%$ No significant abnormality in appearance. |
| | LBM Series | |
| Test Methods and Remarks | Temperature : $85 \pm 2^\circ\text{C}$ Duration : 1000 hrs Recovery : At least 2 hrs of recovery under the standard condition after the test, followed by the measurement within 48 hrs. | |

| 21.Loading at high temperature life test | | |
|--|---|---|
| Specified Value | LB, LBC, LBR, LBMF Series | Inductance change : Within $\pm 10\%$ (LBC3225 Series : Within $\pm 20\%$) No significant abnormality in appearance. |
| | CB, CBC, CBL, CBMF Series | |
| | LBM Series | — |
| Test Methods and Remarks | Temperature : $85 \pm 2^\circ\text{C}$ Duration : 1000 hrs Applied current : Rated current Recovery : At least 2 hrs of recovery under the standard condition after the test, followed by the measurement within 48 hrs. | |

| 22.Low temperature life test | | |
|------------------------------|---|--|
| Specified Value | LB, LBC, LBR, LBMF Series | Inductance change : Within $\pm 10\%$ No significant abnormality in appearance. |
| | CB, CBC, CBL, CBMF Series | |
| | LBM Series | |
| Test Methods and Remarks | Temperature : $-40 \pm 2^\circ\text{C}$ Duration : 1000 hrs Recovery : At least 2 hrs of recovery under the standard condition after the test, followed by the measurement within 48 hrs. | |

| 23.Standard condition | | |
|-----------------------|---------------------------|---|
| Specified Value | LB, LBC, LBR, LBMF Series | Standard test conditions Unless specified, Ambient temperature is $20 \pm 15^\circ\text{C}$ and the Relative humidity is $65 \pm 20\%$. If there is any doubt about the test results, further measurement shall be had within the following limits: Ambient Temperature: $20 \pm 2^\circ\text{C}$ Relative humidity: $65 \pm 5\%$ Inductance value is based on our standard measurement systems. |
| | CB, CBC, CBL, CBMF Series | |
| | LBM Series | |

▶ This catalog contains the typical specification only due to the limitation of space. When you consider the purchase of our products, please check our specification.
For details of each product (characteristics graph, reliability information, precautions for use, and so on), see our Web site (<http://www.ty-top.com/>).

WIRE-WOUND CHIP INDUCTORS (LB SERIES), WIRE-WOUND CHIP POWER INDUCTORS (CB SERIES), WIRE-WOUND CHIP INDUCTORS FOR SIGNAL LINES (LB SERIES M TYPE)

■ PRECAUTIONS

| 1. Circuit Design | |
|---|---|
| Precautions | <p>◆Operating environment</p> <p>1. The products described in this specification are intended for use in general electronic equipment, (office supply equipment, telecommunications systems, measuring equipment, and household equipment). They are not intended for use in mission-critical equipment or systems requiring special quality and high reliability (traffic systems, safety equipment, aerospace systems, nuclear control systems and medical equipment including life-support systems,) where product failure might result in loss of life, injury or damage. For such uses, contact TAIYO YUDEN Sales Department in advance.</p> |
| 2. PCB Design | |
| Precautions | <p>◆Land pattern design</p> <p>1. Please contact any of our offices for a land pattern, and refer to a recommended land pattern of a right figure or specifications.</p> |
| Technical considerations | <p>PRECAUTIONS 【Recommended Land Patterns】</p> <p>Surface Mounting</p> <ul style="list-style-type: none"> • Mounting and soldering conditions should be checked beforehand. • Applicable soldering process to those products is reflow soldering only. |
| 3. Considerations for automatic placement | |
| Precautions | <p>◆Adjustment of mounting machine</p> <p>1. Excessive impact load should not be imposed on the products when mounting onto the PC boards.</p> <p>2. Mounting and soldering conditions should be checked beforehand.</p> |
| Technical considerations | <p>1. When installing products, care should be taken not to apply distortion stress as it may deform the products.</p> |
| 4. Soldering | |
| Precautions | <p>◆Reflow soldering(LB and CB Types)</p> <p>1. For reflow soldering with either leaded or lead-free solder, the profile specified in "point for controlling" is recommended.</p> <p>◆Recommended conditions for using a soldering iron</p> <p>1. Put the soldering iron on the land-pattern. Soldering iron's temperature - Below 350°C Duration-3 seconds or less. The soldering iron should not come in contact with inductor directly.</p> |
| Technical considerations | <p>◆Reflow soldering(LB and CB Types)</p> <p>1. Reflow profile</p> <p>Temperature [°C]</p> <p>Heating Time [sec]</p> <p>150~180</p> <p>90±30sec</p> <p>30±10sec</p> <p>230°C min</p> <p>5sec max</p> <p>Peak: 260+0/-5°C</p> <p>◆Recommended conditions for using a soldering iron</p> <p>1. Components can be damaged by excessive heat where soldering conditions exceed the specified range.</p> |
| 5. Cleaning | |
| Precautions | <p>◆Cleaning conditions</p> <p>Washing by supersonic waves shall be avoided.</p> |
| Technical considerations | <p>◆Cleaning conditions</p> <p>If washed by supersonic waves, the products might be broken.</p> |

| 6. Handling | |
|--------------------------|---|
| Precautions | <ul style="list-style-type: none"> ◆ Handling <ol style="list-style-type: none"> 1. Keep the inductors away from all magnets and magnetic objects. ◆ Breakaway PC boards (splitting along perforations) <ol style="list-style-type: none"> 1. When splitting the PC board after mounting inductors, care should be taken not to give any stresses of deflection or twisting to the board. 2. Board separation should not be done manually, but by using the appropriate devices. ◆ Mechanical considerations <ol style="list-style-type: none"> 1. Please do not give the inductors any excessive mechanical shocks. |
| Technical considerations | <ul style="list-style-type: none"> ◆ Handling <ol style="list-style-type: none"> 1. There is a case that a characteristic varies with magnetic influence. ◆ Breakaway PC boards (splitting along perforations) <ol style="list-style-type: none"> 1. Planning pattern configurations and the position of products should be carefully performed to minimize stress. ◆ Mechanical considerations <ol style="list-style-type: none"> 1. There is a case to be damaged by a mechanical shock. |

| 7. Storage conditions | |
|--------------------------|--|
| Precautions | <ul style="list-style-type: none"> ◆ Storage <ol style="list-style-type: none"> 1. To maintain the solderability of terminal electrodes and to keep the packing material in good condition, temperature and humidity in the storage area should be controlled. <ul style="list-style-type: none"> • Recommended conditions <ul style="list-style-type: none"> Ambient temperature : 0~40°C Humidity : Below 70% RH • The ambient temperature must be kept below 30°C. Even under ideal storage conditions, solderability of products electrodes may decrease as time passes. <ul style="list-style-type: none"> For this reason, product should be used within 6 months from the time of delivery. In case of storage over 6 months, solderability shall be checked before actual usage. |
| Technical considerations | <ul style="list-style-type: none"> ◆ Storage <ol style="list-style-type: none"> 1. Under a high temperature and humidity environment, problems such as reduced solderability caused by oxidation of terminal electrodes and deterioration of taping/packaging materials may take place. |





Looking for pricing, stock, or lifecycle information?

Click below to explore more details on WIN SOURCE:

 [View LBM2016T680J on WIN SOURCE](#)

 [Taiyo Yuden Information](#)

Optimize Your Supply Chain with WIN SOURCE Solutions

-  Global Sourcing Solution
-  Obsolete Management
-  Cost Control Management
-  Shortage Management
-  Alternative Solution
-  Excess Inventory Management