



**THE DATASHEET OF  
WU732BTTD20L0F**





### features

- Wide terminal type flat chip resistor
- High reliability and performance with T.C.R.  $\pm 75 \times 10^{-6}/K$ , resistance tolerance  $\pm 1\%$
- Suitable for flow and reflow solderings
- This product meets EU RoHS requirements. EU RoHS regulation is not intended for Pb-glass contained in electrode, resistor element and glass.
- AEC-Q200 Tested

### dimensions and construction

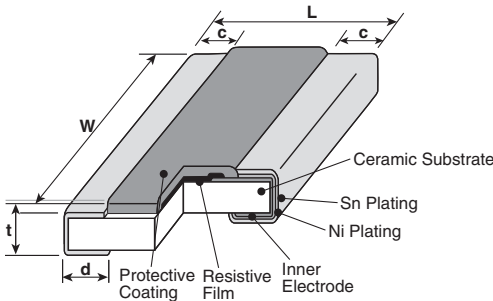

Type (Inch Size Code)	Dimensions inches (mm)				
	L	W	c	d	t
<b>2B</b> (0612)	.063±.006 (1.6±0.15)	.126± <sup>+0.004</sup> <sub>-.012</sub> (3.2± <sup>+0.1</sup> <sub>-.3</sub> )	.016±.008 (0.4±0.2)	.018±.006 (0.45±0.15)	.024±.004 (0.6±0.1)
<b>2B15</b> (0612)	.063±.006 (1.6±0.15)	.126± <sup>+0.004</sup> <sub>-.012</sub> (3.2± <sup>+0.1</sup> <sub>-.3</sub> )	.016±.008 (0.4±0.2)	.018±.006 (0.45±0.15)	.024±.004 (0.6±0.1)

### Derating Curve

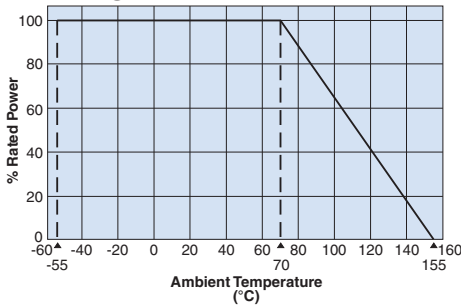

For resistors operated at an ambient temperature of 70°C or above, the power rating shall be derated in accordance with the above derating curve.

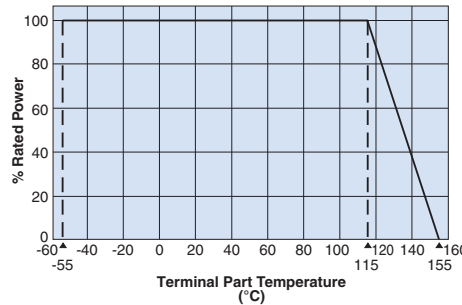

For resistors operated at a terminal part temperature of described for each size or above, the power rating shall be derated in accordance with the above derating curve. Please refer to the "Introduction of the derating curves based on terminal part temperature" in the beginning of the catalog.

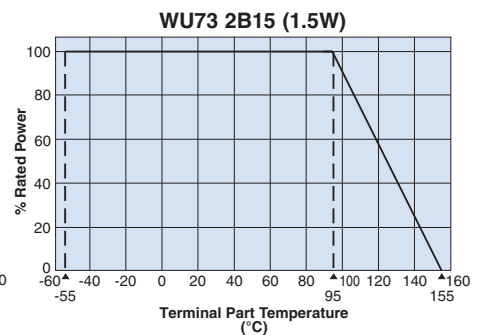

### ordering information

<b>WU73</b>	<b>2B</b>	<b>T</b>	<b>TD</b>	<b>10L0</b>	<b>F</b>
Type	Size	Termination Material	Packaging	Nominal Resistance	Resistance Tolerance
WU73	2B: 1W 2B15: 1.5W	T : Sn	TD: 7" 4mm pitch punched paper For further information on packaging, please refer to Appendix A	4 digits: all values less than 100mΩ are expressed in mΩ with "L" as decimal. Ex: 10mΩ = 10L0	F: ±1%

Contact us when you have control request for environmental hazardous material other than the substance specified by EU RoHS.

Specifications given herein may be changed at any time without prior notice. Please confirm technical specifications before you order and/or use.

11/16/23

## applications and ratings

Part Designation	Power Rating	Rated Ambient Temperature	Rated Terminal Part Temperature	T.C.R. (X 10 <sup>-6</sup> /K)	Resistance Range (Ω) E-24, 25m, 50m*1	Resistance Tolerance	Operating Temperature Range
WU732B	1.0W	70°C	115°C	±100	10m~12m	F: ±1%	-55°C to +155°C
				±75	13m~27m		
				±100	30m~100m		
WU732B15	1.5W*2	70°C	95°C	±100	10m~12m	F: ±1%	-55°C to +155°C
				±75	13m~27m		
				±100	30m~100m		

Rated voltage =  $\sqrt{\text{Power rating} \times \text{resistance value}}$

\*1 25mΩ and 50mΩ are available

\*2 If you use at the rated power, please keep the condition that the terminal of the resistor is below the rated terminal part temperature.

Please refer to the derating curves based on the terminal temperature of right side on the next page.

If any questions should arise whether to use the "Rated Ambient Temperature" or the "Rated Terminal Part Temperature," please give priority to the "Rated Terminal Part Temperature." Prior to use and for more details refer to "Introduction of the derating curves on the terminal part temperature" in the beginning of the catalog.

## environmental applications

### Temperature Rise

WU73 2B

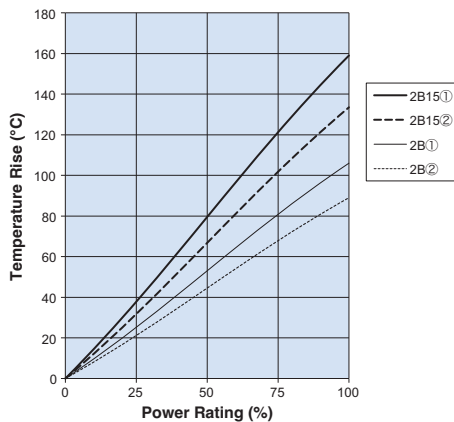

Regarding the temperature rise, the value of the temperature varies per conditions and board for use since the temperature is measured under our measuring conditions.

Measurement condition  
Room temperature: 25°C  
PCB: FR-4t = 1.6mm  
Cu foil thickness: 35μm

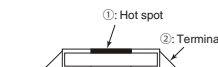

### One-Pulse Limiting Electric Power

WU73 2B/2B15

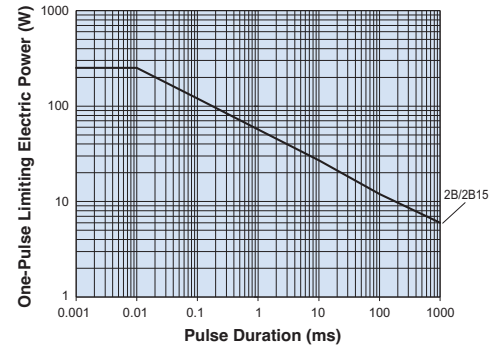

Please ask us about the resistance characteristic of continuous applied pulse. The pulse endurance values are not assured values, so be sure to check the products on actual equipment when you use them.

## Performance Characteristics

Parameter	Requirement Δ R ±(%+0.005Ω)		Test Method
	Limit	Typical	
Resistance	Within specified tolerance	—	25°C
T.C.R.	Within specified T.C.R.	—	+25°C/-55°C and +25°C/+125°C
Overload (Short time)	±2%	±0.2%	Rated Voltage x 2 for 5 seconds
Resistance to Solder Heat	±1%	±0.2%	260°C ± 5°C, 10 seconds ± 1 second
Bending Test	±1%	±0.1%	Holding point 90mm, Bending 1 time, Bending 5mm
Rapid Change of Temperature	±2%	±0.3%	-55°C (30 minutes), +125°C (30 minutes), 1000 cycles
Moisture Resistance	±2%	±0.1%	40°C ± 2°C, 90%-95% RH, 1000 hours, 1.5 hr ON, 0.5 hr OFF cycle
Endurance at 70°C	±2%	±0.2%	70°C ± 2°C or rated terminal part temperature ±2°C, 1000 hours, 1.5 hr ON, 0.5 hr OFF cycle
High Temperature Exposure	±1%	±0.1%	+155°C, 1000 hours

Additional environmental applications can also be found at [www.koaspeer.com](http://www.koaspeer.com)

Specifications given herein may be changed at any time without prior notice. Please confirm technical specifications before you order and/or use.

11/16/23

## Looking for pricing, stock, or lifecycle information?

Click below to explore more details on WIN SOURCE:

⊖ [View WU732BTDD20L0F](#) on WIN SOURCE

⊖ [KOA Speer](#) Information

## Optimize Your Supply Chain with WIN SOURCE Solutions

- ✓ Global Sourcing Solution
- ✓ Obsolete Management
- ✓ Cost Control Management
- ✓ Shortage Management
- ✓ Alternative Solution
- ✓ Excess Inventory Management