



**THE DATASHEET OF
AP22615BWU-7**



Description

The AP22815/615 are 3A, single-channel, current-limited, high-side power switches with output overvoltage protection (OVP) optimized for USB and other hot-swap applications. The AP22815/615 comply with USB standards and are available with both polarities of Enable input. The devices also possess fixed and adjustable current-limited features optimized for applications requiring precise current-limiting support. They have USB PD3.0 fast role-swap functions, and the output voltage recovers to a valid USB voltage range within 110µs during the USB PD fast role-swap event.

The devices have fast short-circuit and output overvoltage response times for improved system robustness. Both the TSOT25 and TSOT26 packages integrate discharge circuitry inside the OUT pin. They provide a complete protection solution for applications subject to heavy capacitive loads and the prospect of short circuits, and offer output overvoltage, reverse-current, overcurrent, overtemperature, and short-circuit protection, as well as controlled rise time and undervoltage lockout functionality. A 7ms deglitch capability on the open-drain flag output prevents false overcurrent, overvoltage, and overtemperature reporting, and does not require any external components.

The AP22815 is available in a standard green TSOT25 package with RoHS compliancy. The AP22615 is available in a standard Green TSOT26 package with RoHS compliancy.

Features

- Input Voltage Range: 3.0V to 5.5V
- 40mΩ On-Resistance
- Built-In Soft-Start with 2.1ms Typical Rise Time
- Fault Report (FLG) with Blanking Time (7ms Typ)
- Accurate Adjustable Current Limit, 0.4A to 4.0A (AP22615 Only)
- ESD Protection: 2kV HBM, 200V MM
- Active-Low or Active-High Enable
- Protection Functions:
 - Output Overvoltage with Auto Recovery
 - Overcurrent with Auto Recovery
 - Short-Circuit with Auto Recovery
 - Overtemperature with Auto Recovery
- Output Reverse Voltage/Current Protection
- Fast Role-Swap Function
- Thermally Efficient, Low-Profile Package
- UL Recognized, File Number E322375
- IEC60950-1 CB Scheme Certified
- IEC62368-1 CB Scheme Certified
- **Totally Lead-Free & Fully RoHS Compliant (Notes 1 & 2)**
- **Halogen and Antimony Free. "Green" Device (Note 3)**
- **For automotive applications requiring specific change control (i.e. parts qualified to AEC-Q100/101/104/200, PPAP capable, and manufactured in IATF 16949 certified facilities), please [contact us](mailto:contact@diodes.com) or your local Diodes representative.**

<https://www.diodes.com/quality/product-definitions/>

- Notes:
1. No purposely added lead. Fully EU Directive 2002/95/EC (RoHS), 2011/65/EU (RoHS 2) & 2015/863/EU (RoHS 3) compliant.
 2. See <https://www.diodes.com/quality/lead-free/> for more information about Diodes Incorporated's definitions of Halogen- and Antimony-free, "Green" and Lead-free.
 3. Halogen- and Antimony-free "Green" products are defined as those which contain <900ppm bromine, <900ppm chlorine (<1500ppm total Br + Cl) and <1000ppm antimony compounds.

Pin Assignments

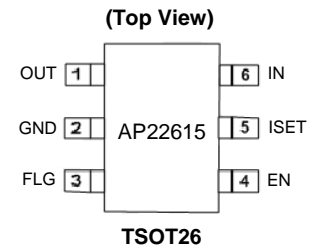
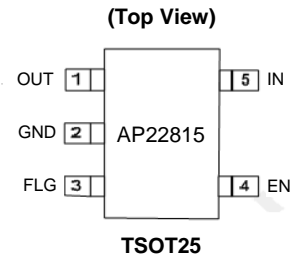

Applications

- Integrated load switches in ultrabook PCs
- Power up/down sequencing in ultrabook PCs
- Notebooks, netbook, tablet PCs, set-top boxes
- Solid state drives (SSDs)
- Consumer electronics
- USB chargers
- Telecom systems

Typical Applications Circuit (Note 4)

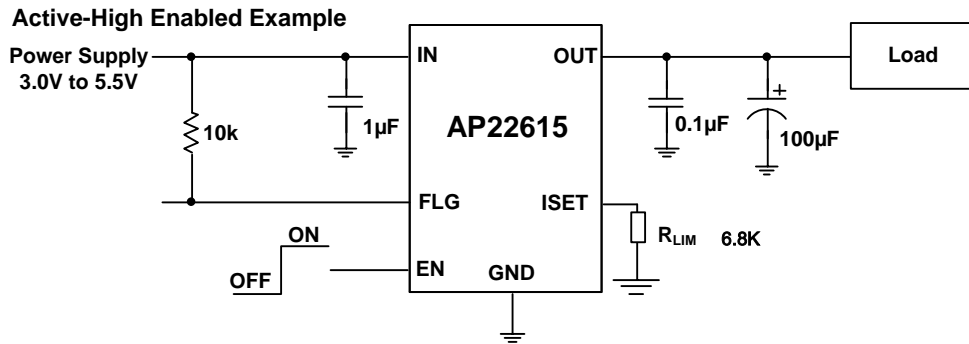
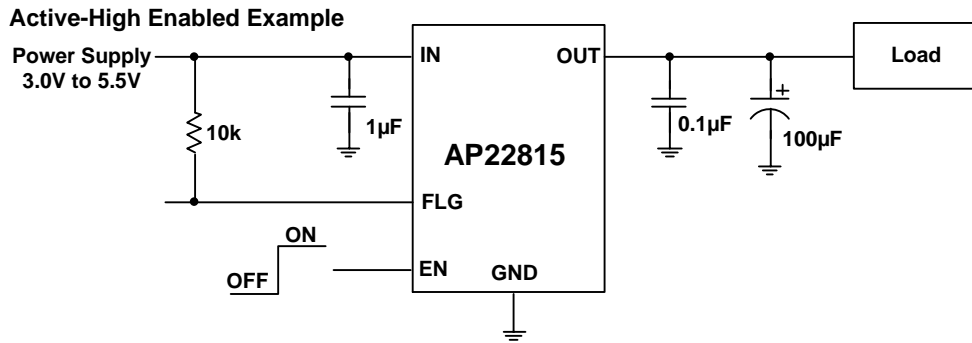

Note 4. Applying a 1µF input capacitor leads to a large V_{IN} spike, so it is recommended to use a 10µF capacitor instead.

Pin Descriptions

AP22815	AP22615	Pin Name	Pin function
TSOT25	TSOT26		
1	1	OUT	Voltage Output Pin
2	2	GND	Ground Pin of the Circuitry
3	3	FLG	Overcurrent and Overtemperature Fault Report; Open-Drain Flag is Active Low When Triggered.
4	4	EN	Enable Input (Active Low or Active High).
NC	5	ISET	AP22815: NC pin AP22615: Set OCP current by attaching resistor. The current limit: $I_{LIM} (A) = 6800/R_{LIM} (\Omega)$
5	6	IN	Voltage Input Pin

Functional Block Diagram

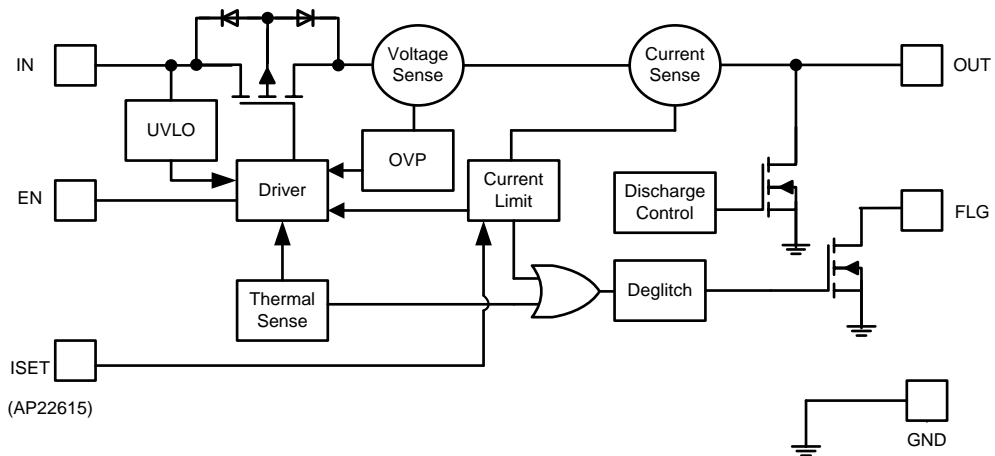

Absolute Maximum Ratings (@ $T_A = +25^\circ\text{C}$, unless otherwise specified.) (Note 5)

Symbol	Parameter	Ratings	Unit	
ESD HBM	Human Body ESD Protection	2000	V	
ESD MM	Machine Model ESD Protection	200	V	
V_{IN}	Input Voltage	-0.3 to 6.0	V	
V_{OUT}	Output Voltage (V_{OUT} to GND, V_{OUT} to V_{IN})	-0.3 to 28	V	
V_{EN}	Enable Voltage	-0.3 to ($V_{IN} + 0.3$)	V	
V_{ISET}	ISET Voltage	-0.3 to ($V_{IN} + 0.3$)	V	
I_L	Load Current	Internal Limited	A	
$T_{J(max)}$	Maximum Junction Temperature	+150	$^\circ\text{C}$	
T_{STG}	Storage Temperature	-65 to +150	$^\circ\text{C}$	
$R_{\theta JA}$	Thermal Resistance, Junction to Ambient (Note 6)	TSOT25	85	$^\circ\text{C/W}$
		TSOT26	80	
$R_{\theta JC}$	Thermal Resistance, Junction to Case (Note 6)	TSOT25	32	$^\circ\text{C/W}$
		TSOT26	30	

Note: 5. Stresses greater than the *Absolute Maximum Ratings* specified above can cause permanent damage to the device. These are stress ratings only; functional operation of the device at these or any other conditions exceeding those indicated in this specification is not implied. Device reliability can be affected by exposure to absolute maximum rating conditions for extended periods of time.
6. $R_{\theta JA}$ and $R_{\theta JC}$ are measured at $T_A = +25^\circ\text{C}$ on a high effective thermal conductivity four-layer test board per JEDEC 51-7.

Recommended Operating Conditions (Note 7)

Symbol	Parameter	Min	Max	Unit
V_{IN}	Input Voltage	3.0	5.5	V
I_{OUT}	Output Current, $4.0\text{V} \leq V_{IN} \leq 5.5\text{V}$	0	3	A
	Output Current, $3.0\text{V} \leq V_{IN} < 4.0\text{V}$	0	1.5	A
V_{IL}	EN Input Logic Low Voltage	0	0.4	V
R_{LIM}	Current-Limit Threshold Resistor Range (1% Initial Tolerance)	1.94	6.8	$\text{k}\Omega$
V_{OUT}	Output Voltage	0	23	V
V_{IH}	EN Input Logic High Voltage	1.2	V_{IN}	V
T_A	Operating Ambient Temperature	-40	+85	$^\circ\text{C}$

Note: 7. Refer to the typical application circuit.

Electrical Characteristics ($V_{IN} = 5.0V$ @ $T_A = +25^{\circ}C$, $C_{IN} = 1\mu F$, $C_L = 100nF$, unless otherwise specified.)

Symbol	Parameter	Test Conditions	Min	Typ	Max	Unit
V_{UVLO}	Input UVLO	V_{IN} Rising	2.1	2.5	2.9	V
ΔV_{UVLO}	Input UVLO Hysteresis	V_{IN} Decreasing	—	180	—	mV
I_{SHDN}	Input Shutdown Current	Disabled, OUT = Open (Discharge Current Included)	—	0.1	10	μA
I_Q	Input Quiescent Current	Enabled, OUT = Open	—	300	—	μA
I_{LEAK}	Input Leakage Current	Disabled, OUT Grounded	—	0.1	1	μA
I_{REV}	Reverse Leakage Current	Disabled, $V_{IN} = 0V$, $V_{OUT} = 5V$, I_{REV} at OUT	—	0.5	15	μA
		Disabled, $V_{IN} = 0V$, $V_{OUT} = 20V$, I_{REV} at OUT	—	0.5	30	μA
$R_{DS(ON)}$	Switch On-Resistance	(AP22815) $V_{IN} = 5.0V$, $I_{OUT} = 1A$	—	40	50	m Ω
I_{LIMIT}	Overload Current Limit	(AP22815) $V_{IN} = 5V$, $V_{OUT} = 4V$	3.1	3.6	4.2	A
		(AP22615) $V_{IN} = 5V$, $V_{OUT} = 4V$, $R_{LIM} = 1.94k\Omega$	3.1	3.6	4.2	A
		(AP22615) $V_{IN} = 5V$, $V_{OUT} = 4V$, $R_{LIM} = 6.8k\Omega$	0.75	1	—	A
I_{SHORT}	Short-Circuit Current Limit	Enabled, Output Short to Ground	—	1	—	A
t_{SHORT}	Short-Circuit Response Time	$V_{IN} = 5V$, No Load	—	5	—	μs
V_{IL}	EN Input Logic Low Voltage	$V_{IN} = 5V$	—	—	0.4	V
V_{IH}	EN Input Logic High Voltage	$V_{IN} = 5V$	1.2	—	—	V
$I_{LEAK-EN}$	EN Input Leakage	$V_{IN} = 5V$, $V_{EN} = 0V$ and $5.5V$	—	1	2	μA
I_{LEAK-O}	Output Leakage Current	Disabled, $V_{OUT} = 0V$	—	0.5	1	μA
$t_{D(ON)}$	Output Turn-On Delay Time	$C_L = 10\mu F$, $R_{LOAD} = 10\Omega$ @ $V_{IN} = 5V$ (Figure 1)	—	2.2	—	ms
t_R	Output Turn-On Rise Time	$C_L = 10\mu F$, $R_{LOAD} = 10\Omega$ @ $V_{IN} = 5V$ (Figure 1)	1.0	1.9	3.5	ms
$t_{D(OFF)}$	Output Turn-Off Delay Time	$C_L = 10\mu F$, $R_{LOAD} = 10\Omega$ @ $V_{IN} = 5V$ (Figure 1)	—	0.02	—	ms
t_F	Output Turn-Off Fall Time	$C_L = 10\mu F$, $R_{LOAD} = 10\Omega$ @ $V_{IN} = 5V$ (Figure 1)	—	0.2	—	ms
R_{FLG}	FLG Output FET On-Resistance	$I_{FLG} = 10mA$	—	40	60	Ω
I_{FOH}	FLG Off Current	$V_{FLG} = 5V$	—	0.01	1	μA
t_{BLANK}	FLG Blanking Time	Assertion or Deassertion due to Overvoltage, Overcurrent, and Overtemperature Condition	2	7	20	ms
R_{DIS}	Discharge Resistance	$V_{IN} = 5V$, Disabled, $V_{OUT} = 1V$	—	100	—	Ω
T_{SHDN}	Thermal Shutdown Threshold	Enabled	—	+140	—	$^{\circ}C$
T_{HYS}	Thermal Shutdown Hysteresis	—	—	+35	—	$^{\circ}C$
V_{OV_TRIP}	Output OVP Lockout	V_{OUT} Rising Threshold	5.5	5.7	5.9	V
		V_{OUT} Falling Threshold	—	5.6	—	V
OUT_{HYS}	Output OVP Hysteresis	—	—	0.1	—	V
t_{OVP}	OVP Response Time	$I_{OUT} = 0.5A$, $C_L = 1\mu F$, V_{OUT} from $5.5V$ to $6V$	—	1	—	μs
V_{RVP}	Reverse-Voltage Comparator Trip Point	$V_{OUT} - V_{IN}$	—	65	—	mV

Typical Performance Characteristics

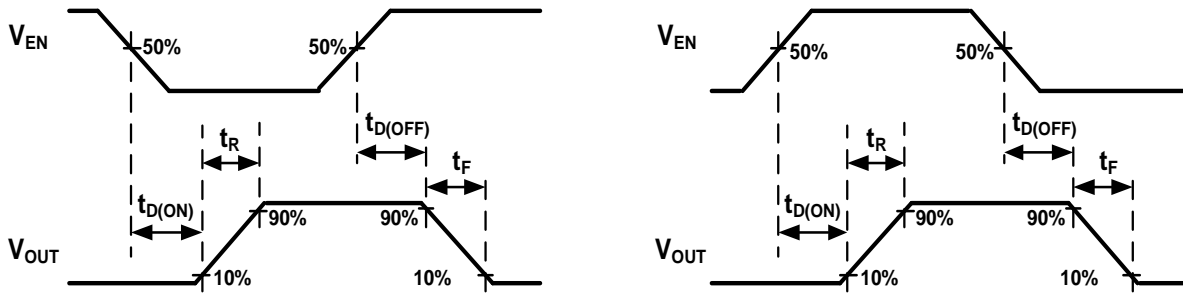
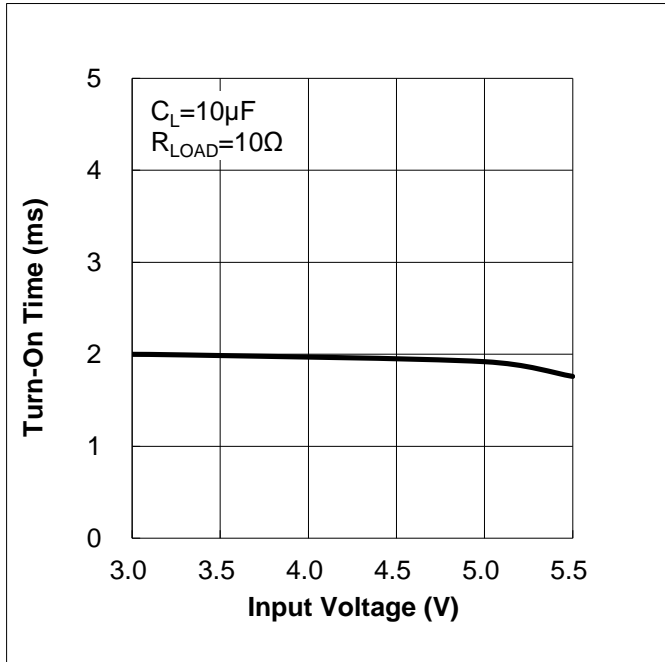

Figure 1. Voltage Waveforms

Typical Performance Characteristics (continued) ($T_A = +25^\circ\text{C}$, $V_{IN} = 5\text{V}$, $C_{IN} = 1\mu\text{F}$, $C_L = 0.1\mu\text{F}$, unless otherwise specified.)

Turn-On Time vs. Input Voltage



Turn-Off Time vs. Input Voltage

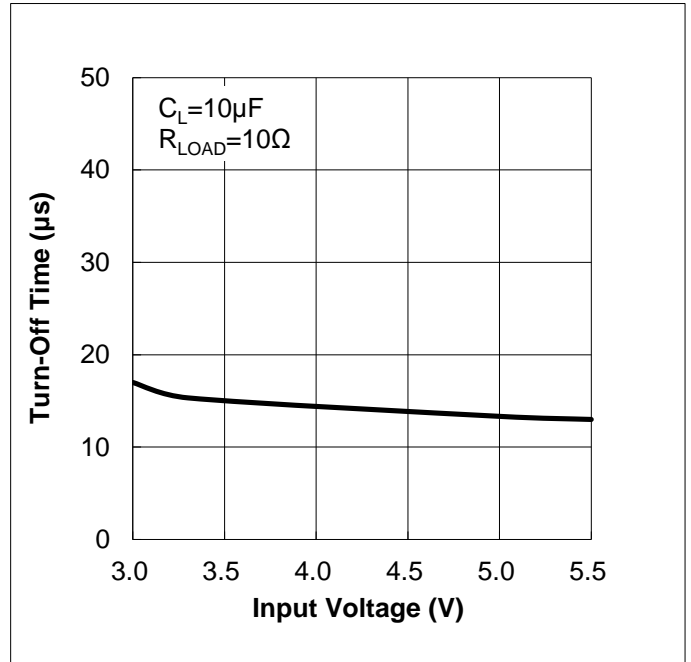

Rise Time vs. Input Voltage

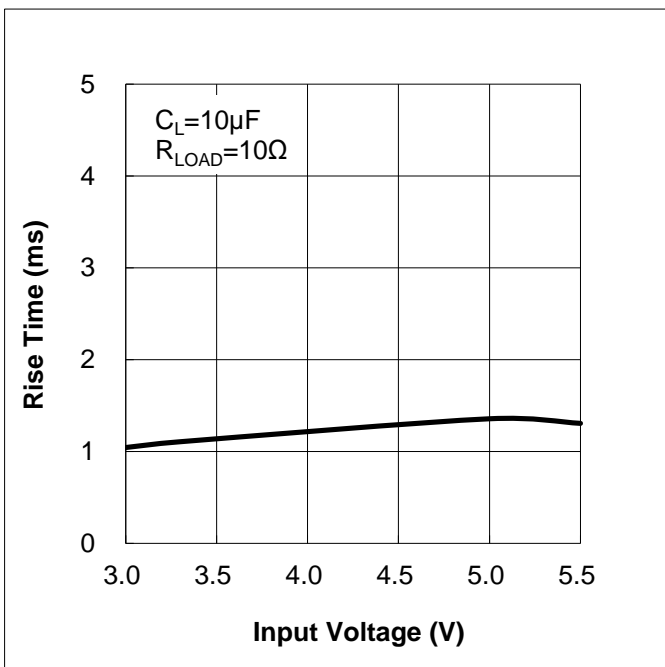

Fall Time vs. Input Voltage

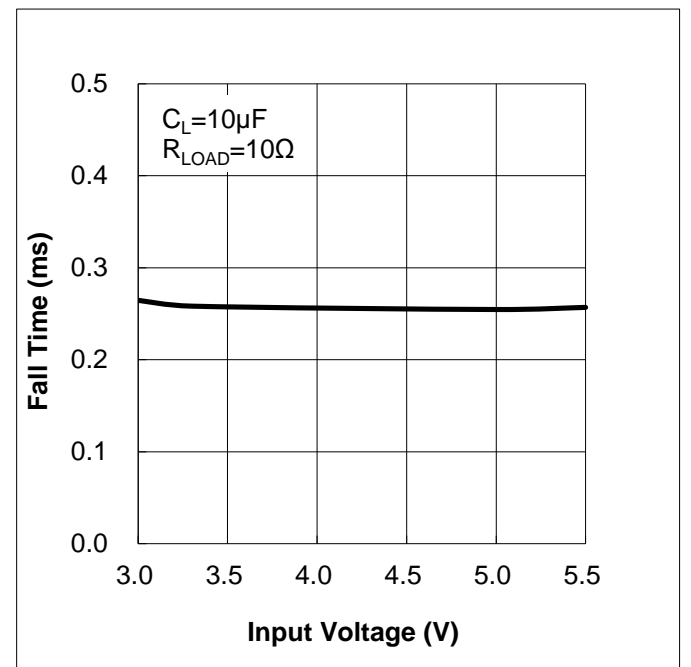

Typical Performance Characteristics (continued) ($T_A = +25^\circ\text{C}$, $V_{IN} = 5\text{V}$, $C_{IN} = 1\mu\text{F}$, $C_L = 0.1\mu\text{F}$, unless otherwise specified.)

Input Quiescent Current vs. Temperature

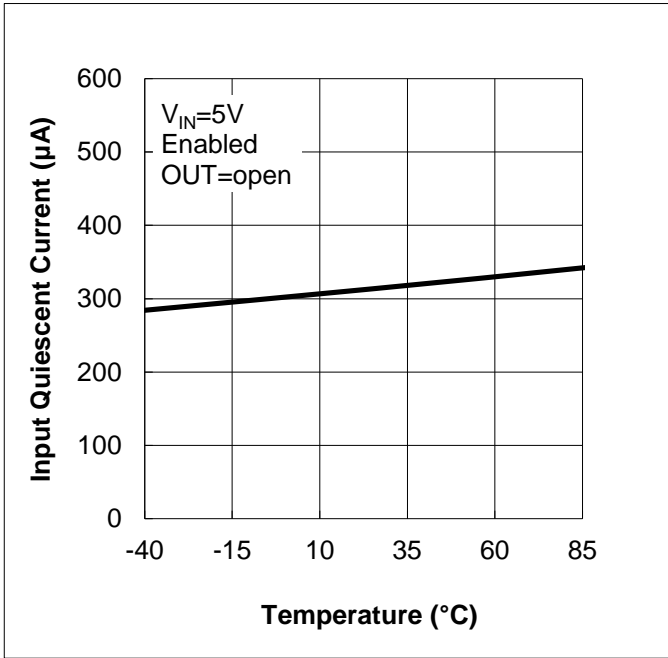

Input Shutdown Current vs. Temperature

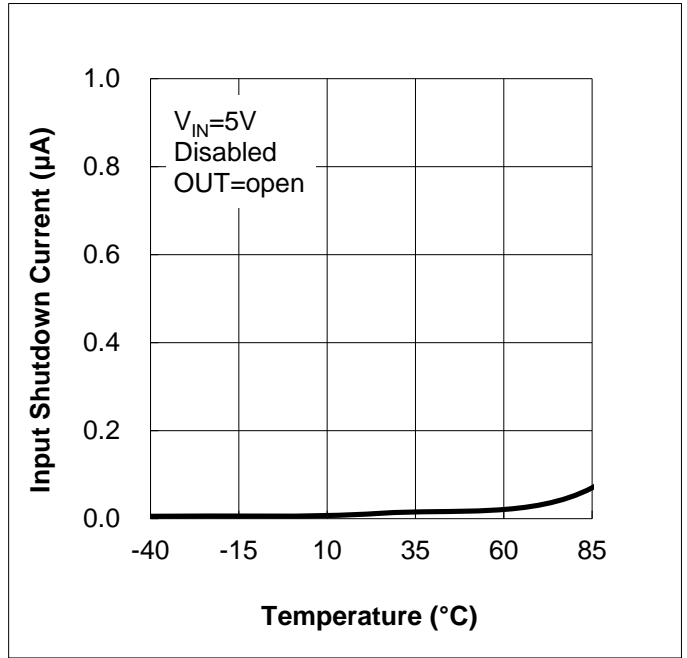

$R_{DS(ON)}$ vs. Output Current

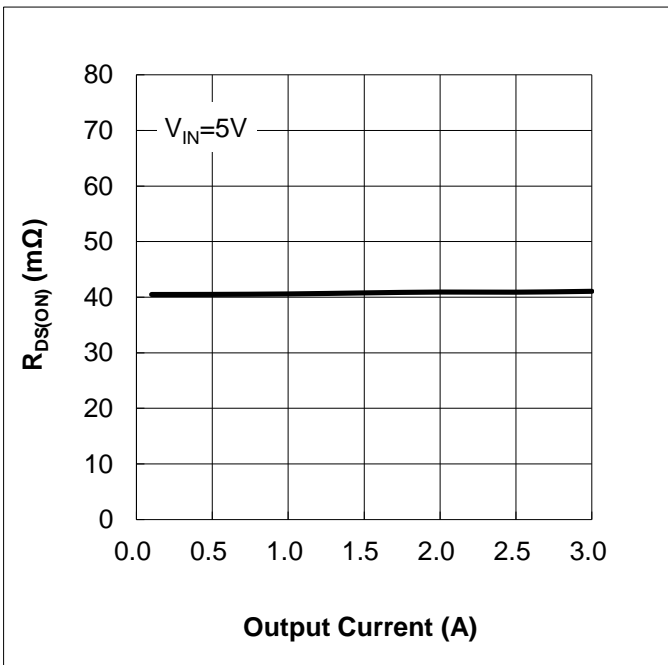

$R_{DS(ON)}$ vs. Temperature

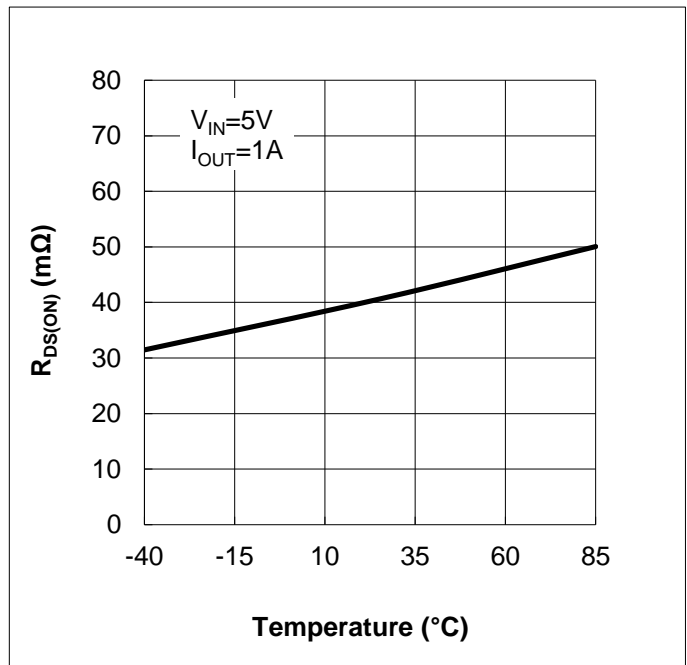

Typical Performance Characteristics (continued) ($T_A = +25^\circ\text{C}$, $V_{IN} = 5\text{V}$, $C_{IN} = 1\mu\text{F}$, $C_L = 0.1\mu\text{F}$, unless otherwise specified.)

Input Leakage Current vs. Temperature

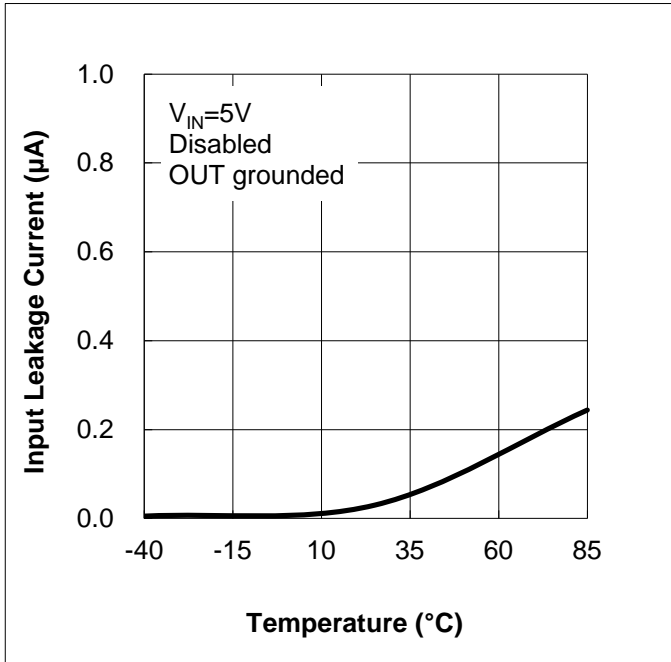

Under Voltage Lockout vs. Temperature

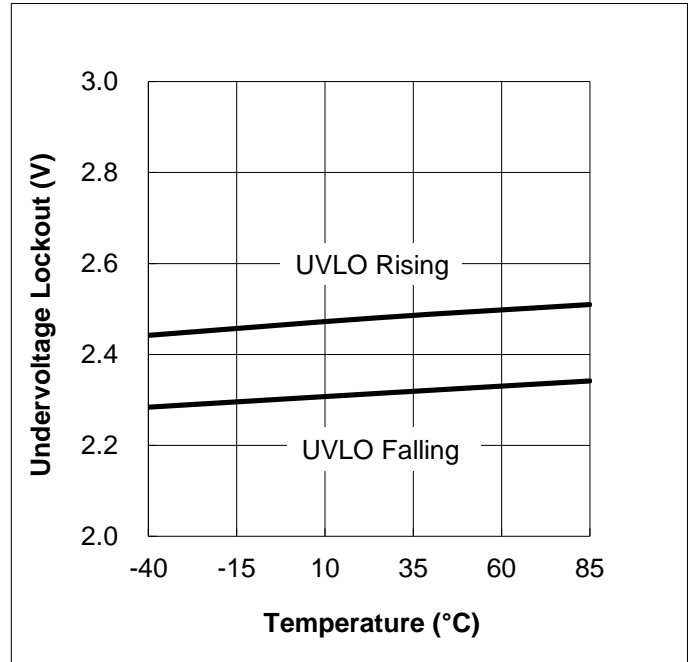

Short-Circuit Output Current vs. Temperature

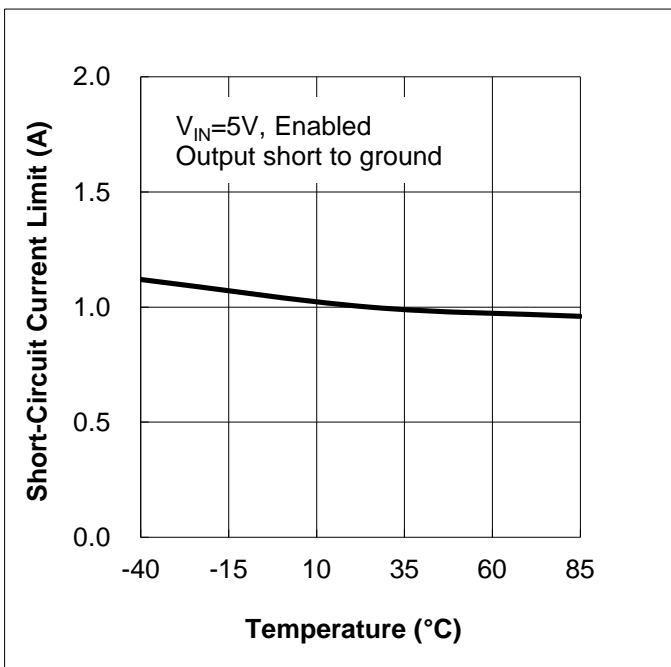

Reverse-Voltage Comparator Trip vs. Temperature

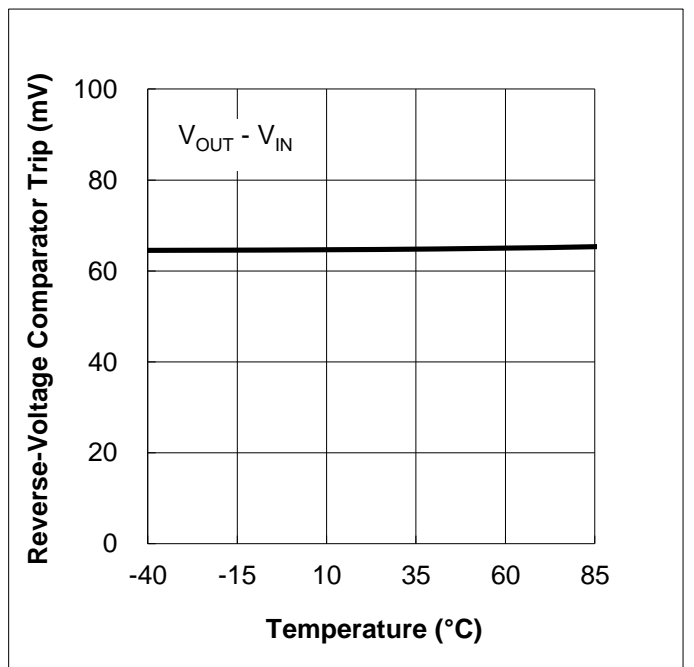

Typical Performance Characteristics (continued) ($T_A = +25^\circ\text{C}$, $V_{IN} = 5\text{V}$, $C_{IN} = 1\mu\text{F}$, $C_L = 0.1\mu\text{F}$, unless otherwise specified.)

Reverse Leakage Current vs. Temperature

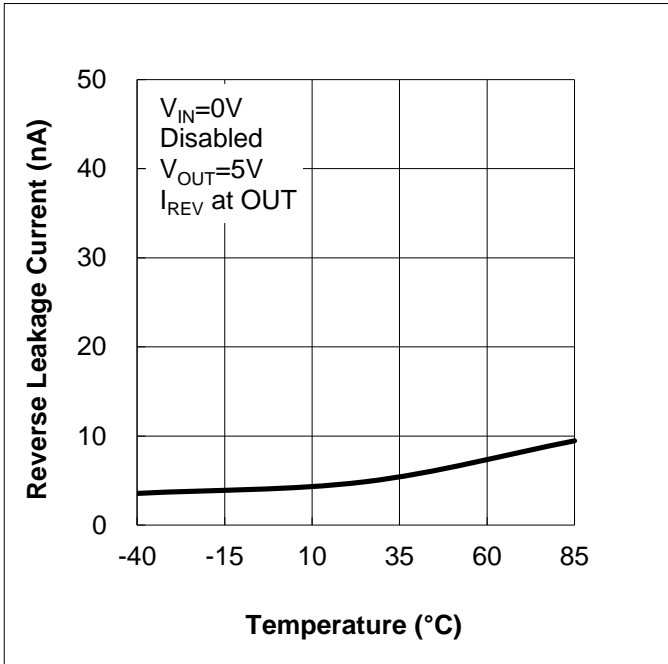

Reverse Leakage Current vs. Temperature

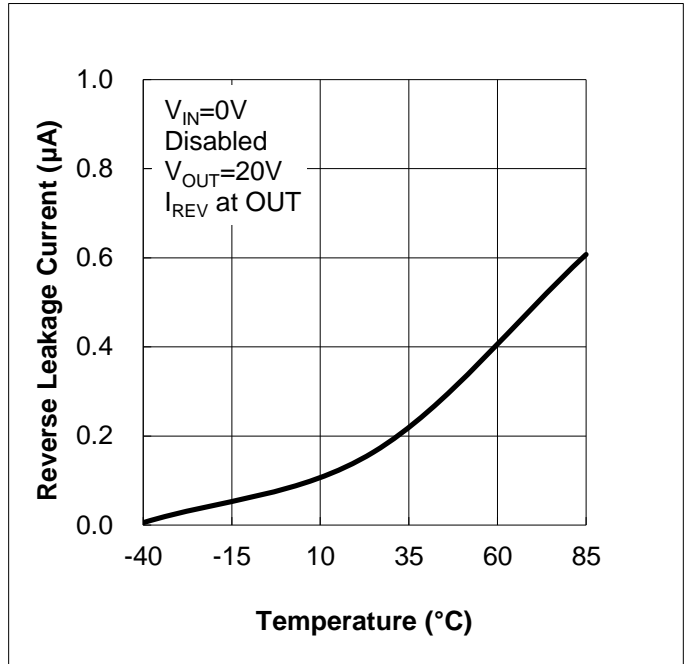

Over Load Current Limit vs. R_{LIMIT}

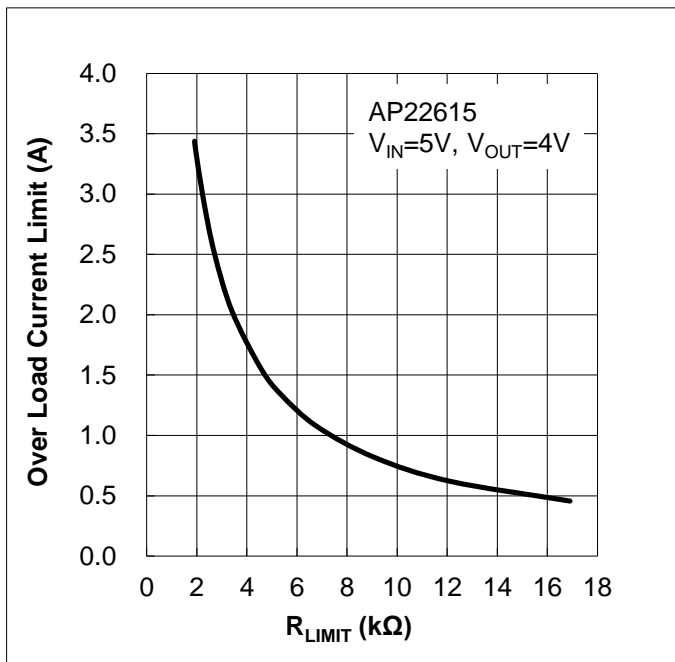

Over Load Current Limit vs. Temperature

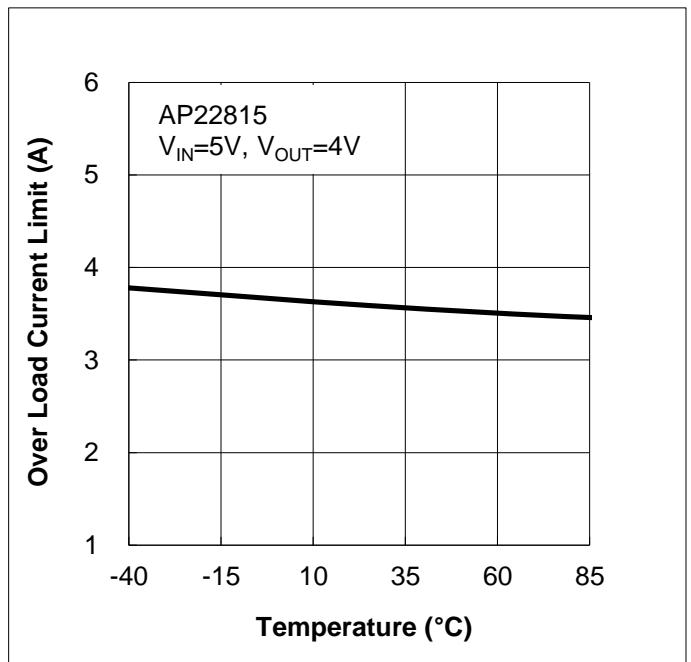

Typical Performance Characteristics (continued) ($T_A = +25^\circ\text{C}$, $V_{IN} = 5\text{V}$, $C_{IN} = 1\mu\text{F}$, $C_L = 0.1\mu\text{F}$, unless otherwise specified.)

Device Enabled Into Short-Circuit

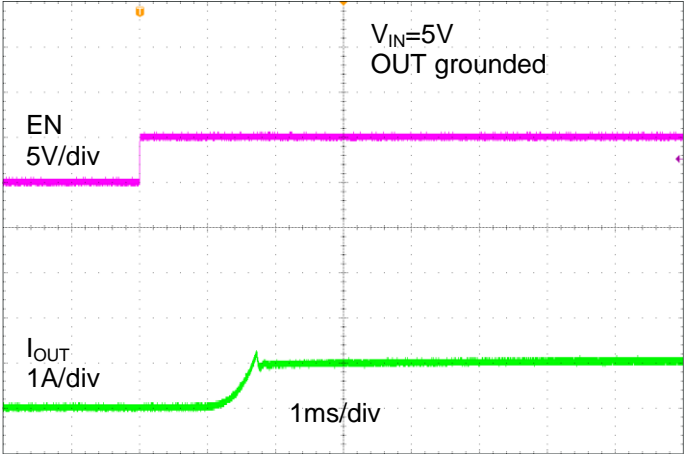

Inrush Current

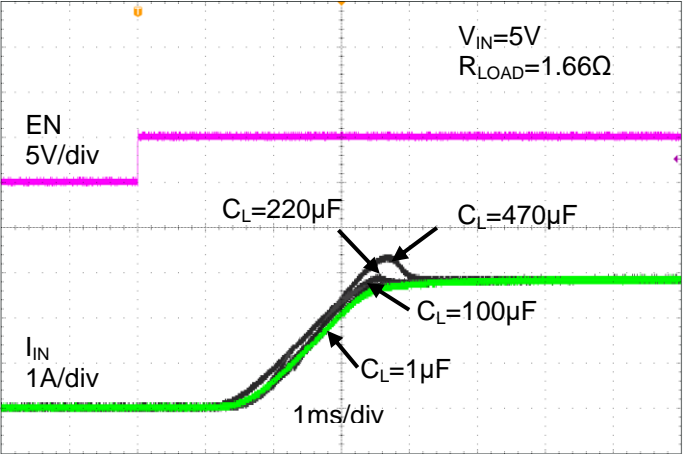

Application Information

Input and Output Capacitors

It is required to place a 1 μ F X7R or X5R ceramic bypass capacitor between IN and GND—close to the device. It is recommended to place a high-value capacitor (10 μ F or 47 μ F) close to the input pin when the output transient load is heavy. This precaution reduces power-supply transients that can cause ringing on the input.

Connecting a minimum 100 μ F low ESR electrolytic or tantalum capacitor (or 22 μ F MLCC) between OUT and GND is also required for hot-plug applications, which is required to bypass the output with a 0.1 μ F ceramic capacitor that improves the immunity of the device to short-circuit transients. The bulky 100 μ F or larger capacitors help reduce output droop voltage when a device is plugged in. When abnormal short-circuit condition happens, these capacitors can also reduce output negative voltage due to parasitic inductive effects and avoid device damage.

Note that without the bypass capacitors, an output short can cause ringing on the input. If the voltage is over the maximum voltage rating, it will destroy the internal control circuitry even if the duration is short.

FLG Response

When an overcurrent, overtemperature, or overvoltage shutdown condition is encountered, the FLG open-drain output goes active low after a nominal 7ms deglitch timeout. The FLG output remains low until overcurrent, overtemperature, or overvoltage conditions are removed. Connecting a heavy capacitive load to the output of the device can cause a momentary overcurrent condition, which does not trigger the FLG due to the 7ms deglitch timeout. The AP22815/AP22615 is designed to eliminate false overcurrent reporting without the need for external components, removing unwanted pulses.

When V_{IN} operates below 4V, the lower V_{IN} voltage results in higher equivalent R_{ON} and can potentially cause the FLG signal to be triggered at a higher output current.

Overcurrent and Short-Circuit Protection

An internal-sensing FET is employed to check for overcurrent conditions. Unlike current-sense resistors, sense FETs do not increase the series resistance of the current path. When an overcurrent condition is detected, the device maintains a constant output current and reduces the output voltage accordingly. Complete shutdown occurs only if the fault stays long enough to activate thermal limiting.

Three possible overload conditions can occur. In the first condition, the output has been shorted to GND before the device is enabled or before V_{IN} has been applied. The AP22815/AP22615 senses the short circuit and immediately clamps the output current to a certain safe level.

In the second condition, an output short or overload occurs while the device is enabled. At the instance the overload occurs, higher current can flow for a very short period of time before the current-limit function can react. After the current-limit function has tripped, the device switches into the current-limiting mode, and the current is clamped at I_{LIMIT} or I_{SHORT} .

In the third condition, the load is gradually increased beyond the recommended operating current. The current is permitted to rise until the current-limit threshold (I_{TRIG}) is reached or until the thermal limit of the device is exceeded. The AP22815/AP22615 is capable of delivering current up to the current-limit threshold without damaging the device. Once the threshold is reached, the device switches into its current-limiting mode and is set at I_{LIMIT} .

Thermal Protection

Thermal protection prevents the IC from damage when heavy-overload or short-circuit faults are present for extended periods of time. The AP22815/AP22615 implements thermal sensing to monitor the operating junction temperature of the power distribution switch. Once the die temperature rises to approximately +140°C due to excessive power dissipation in an overcurrent or short-circuit condition the internal thermal sense circuitry turns the power switch off, thus preventing the power switch from damage. Hysteresis is built into the thermal sense circuit, allowing the device to cool down approximately +35°C before the switch turns back on. The switch continues to cycle in this manner until the load fault or input power is removed. The FLG open-drain output is asserted when an overtemperature shutdown or overcurrent occurs with 7ms deglitch.

When V_{IN} operates below 4V, the lower V_{IN} voltage results in higher equivalent R_{ON} and might potentially cause the chip to enter thermal cycling condition by higher output current.

Application Information (continued)

ON/OFF Input Operator

The EN input allows the output current to be switched on and off using a GPIO compatible input. The high signal (switch on) must be at least 1.2V and the low signal (switch off) no higher than 0.4V. This pin should *not* be left floating. It is advisable to hold the EN signal low when applying or removing power.

Undervoltage Lockout (UVLO)

Undervoltage lockout function (UVLO) keeps the internal power switch from being turned on until the power supply has reached at least 2.5V, even if the switch is enabled. Whenever the input voltage falls below approximately 2.3V, the power switch is quickly turned off. This facilitates the design of hot-insertion systems where it is not possible to turn off the power switch before input power is removed.

Discharge Function

The discharge function of the device is active when enable is disabled or de-asserted. The discharge function with the N-MOS power switch implementation is activated and offers a resistive discharge path for the external storage capacitor. This is designed for discharging any residue of the output voltage when either no external output resistance or load resistance is present at the output.

Output Reverse-Voltage/Current Protection

The output reverse-voltage protection turns off the MOSFET switch whenever the output voltage is higher than the input voltage by 65mV, and the MOSFET switch turns on when output reverse-voltage conditions are removed. When reverse voltage is lower than 65mV, the reverse current is regulated at approximately 350mA. When the reverse current continuously increases and the reverse voltage is larger than 65mV, the reverse-voltage protection is triggered.

Fast Role-Swap Function

The AP22615 and AP22815 integrate fast role-swap function, which makes the V_{OUT} recover to 4.75V within 150 μ s when the V_{OUT} drops from high voltage to low. When EN is high, V_{IN} is valid, and V_{OUT} is higher than V_{IN} by 65 mV; the device works at reverse-block mode, and the power FET turns off and stands by for FRS. Once V_{OUT} drops lower than V_{IN} , the power FET is turned on in 150 μ s.

Power Dissipation and Junction Temperature

The low on-resistance of the internal MOSFET allows the small surface-mount packages to pass large currents. Using the maximum operating ambient temperature (T_A) and $R_{DS(ON)}$, the power dissipation can be calculated by:

$$P_D = R_{DS(ON)} \times I^2$$

Finally, to calculate the junction temperature:

$$T_J = P_D \times R_{\theta JA} + T_A$$

Where:

- T_A = Ambient temperature ($^{\circ}$ C)
- $R_{\theta JA}$ = Thermal resistance
- P_D = Total power dissipation

Board Layout Instruction

Placing input and output capacitors, 1 μ F and 0.1 μ F+100 μ F respectively, close and next to the device pins must be implemented to minimize the effects of parasitic inductance. For best performance, all trace lengths must be kept as short as possible. The input and output PCB traces must be as wide as possible. Use a ground plane to enhance the power dissipation capability of the device.

Ordering Information

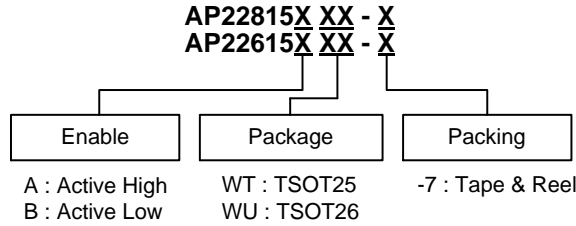

Orderable Part Number	Package Code	Package	Packing		
			Quantity	Carrier	Part Number Suffix
AP22815AWT-7	WT	TSOT25	3,000	7" Tape & Reel	-7
AP22815BWT-7	WT	TSOT25	3,000	7" Tape & Reel	-7
AP22615AWU-7	WU	TSOT26	3,000	7" Tape & Reel	-7
AP22615BWU-7	WU	TSOT26	3,000	7" Tape & Reel	-7

Marking Information

(1) TSOT25

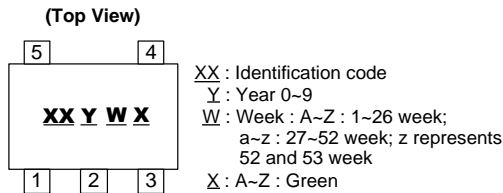

Part Number	Package Type	Identification Code
AP22815AWT-7	TSOT25	P5
AP22815BWT-7	TSOT25	P6

(2) TSOT26

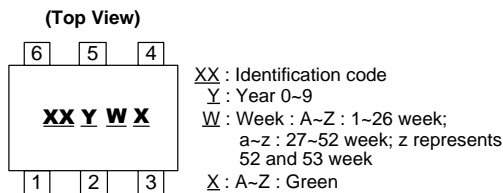

Part Number	Package Type	Identification Code
AP22615AWU-7	TSOT26	P7
AP22615BWU-7	TSOT26	P8

Package Outline Dimensions

Please see <http://www.diodes.com/package-outlines.html> for the latest version.

(1) TSOT25

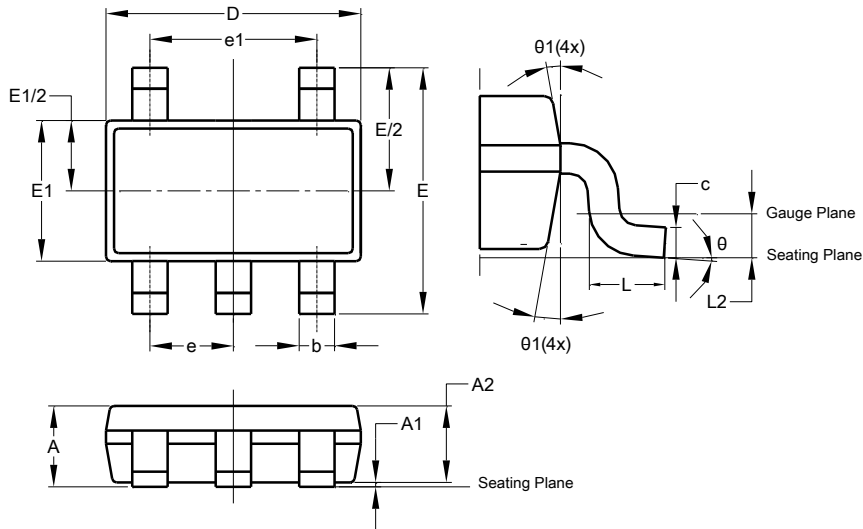

TSOT25			
Dim	Min	Max	Typ
A	-	1.00	-
A1	0.01	0.10	-
A2	0.84	0.90	-
b	0.30	0.45	-
c	0.12	0.20	-
D	-	-	2.90
E	-	-	2.80
E1	-	-	1.60
e	0.95 BSC		
e1	1.90 BSC		
L	0.30	0.50	
L2	0.25 BSC		
θ	0°	8°	4°
θ1	4°	12°	-
All Dimensions in mm			

(2) TSOT26

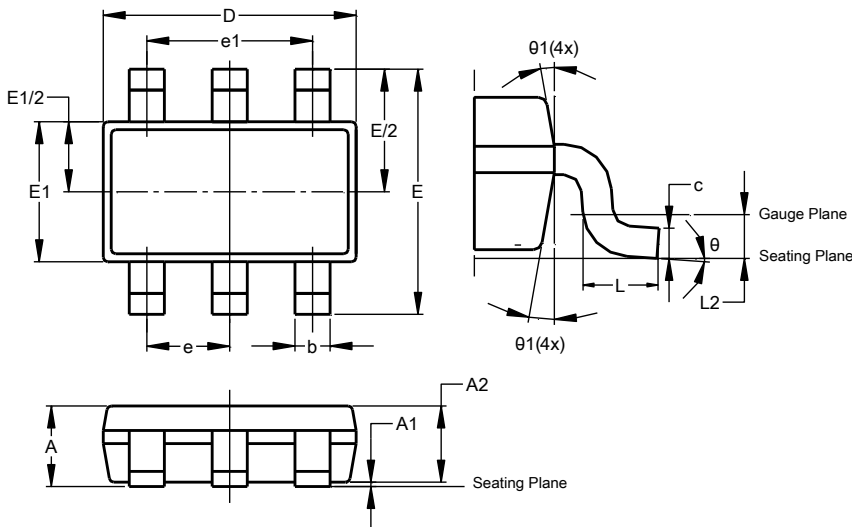

TSOT26			
Dim	Min	Max	Typ
A	-	1.00	-
A1	0.010	0.100	-
A2	0.840	0.900	-
D	2.800	3.000	2.900
E	2.800 BSC		
E1	1.500	1.700	1.600
b	0.300	0.450	-
c	0.120	0.200	-
e	0.950 BSC		
e1	1.900 BSC		
L	0.30	0.50	-
L2	0.250 BSC		
θ	0°	8°	4°
θ1	4°	12°	-
All Dimensions in mm			

Suggested Pad Layout

Please see <http://www.diodes.com/package-outlines.html> for the latest version.

(1) TSOT25

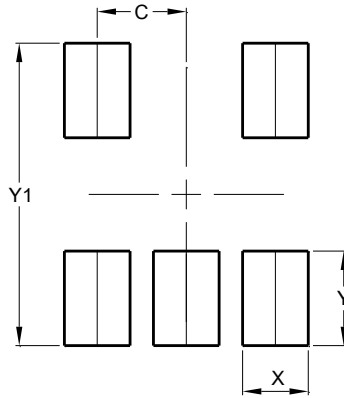

Dimensions	Value (in mm)
C	0.950
X	0.700
Y	1.000
Y1	3.199

(2) TSOT26

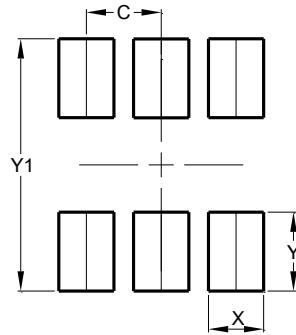

Dimensions	Value (in mm)
C	0.950
X	0.700
Y	1.000
Y1	3.200

Mechanical Data

- Moisture Sensitivity: Level 1 per J-STD-020
- Terminals: Finish – Matte Tin Plated Leads, Solderable per MIL-STD-202, Method 208 ③
- Weight: 0.013 grams (Approximate)

IMPORTANT NOTICE

1. DIODES INCORPORATED (Diodes) AND ITS SUBSIDIARIES MAKE NO WARRANTY OF ANY KIND, EXPRESS OR IMPLIED, WITH REGARDS TO ANY INFORMATION CONTAINED IN THIS DOCUMENT, INCLUDING, BUT NOT LIMITED TO, THE IMPLIED WARRANTIES OF MERCHANTABILITY, FITNESS FOR A PARTICULAR PURPOSE OR NON-INFRINGEMENT OF THIRD PARTY INTELLECTUAL PROPERTY RIGHTS (AND THEIR EQUIVALENTS UNDER THE LAWS OF ANY JURISDICTION).
2. The Information contained herein is for informational purpose only and is provided only to illustrate the operation of Diodes' products described herein and application examples. Diodes does not assume any liability arising out of the application or use of this document or any product described herein. This document is intended for skilled and technically trained engineering customers and users who design with Diodes' products. Diodes' products may be used to facilitate safety-related applications; however, in all instances customers and users are responsible for (a) selecting the appropriate Diodes products for their applications, (b) evaluating the suitability of Diodes' products for their intended applications, (c) ensuring their applications, which incorporate Diodes' products, comply the applicable legal and regulatory requirements as well as safety and functional-safety related standards, and (d) ensuring they design with appropriate safeguards (including testing, validation, quality control techniques, redundancy, malfunction prevention, and appropriate treatment for aging degradation) to minimize the risks associated with their applications.
3. Diodes assumes no liability for any application-related information, support, assistance or feedback that may be provided by Diodes from time to time. Any customer or user of this document or products described herein will assume all risks and liabilities associated with such use, and will hold Diodes and all companies whose products are represented herein or on Diodes' websites, harmless against all damages and liabilities.
4. Products described herein may be covered by one or more United States, international or foreign patents and pending patent applications. Product names and markings noted herein may also be covered by one or more United States, international or foreign trademarks and trademark applications. Diodes does not convey any license under any of its intellectual property rights or the rights of any third parties (including third parties whose products and services may be described in this document or on Diodes' website) under this document.
5. Diodes' products are provided subject to Diodes' Standard Terms and Conditions of Sale (<https://www.diodes.com/about/company/terms-and-conditions/terms-and-conditions-of-sales/>) or other applicable terms. This document does not alter or expand the applicable warranties provided by Diodes. Diodes does not warrant or accept any liability whatsoever in respect of any products purchased through unauthorized sales channel.
6. Diodes' products and technology may not be used for or incorporated into any products or systems whose manufacture, use or sale is prohibited under any applicable laws and regulations. Should customers or users use Diodes' products in contravention of any applicable laws or regulations, or for any unintended or unauthorized application, customers and users will (a) be solely responsible for any damages, losses or penalties arising in connection therewith or as a result thereof, and (b) indemnify and hold Diodes and its representatives and agents harmless against any and all claims, damages, expenses, and attorney fees arising out of, directly or indirectly, any claim relating to any noncompliance with the applicable laws and regulations, as well as any unintended or unauthorized application.
7. While efforts have been made to ensure the information contained in this document is accurate, complete and current, it may contain technical inaccuracies, omissions and typographical errors. Diodes does not warrant that information contained in this document is error-free and Diodes is under no obligation to update or otherwise correct this information. Notwithstanding the foregoing, Diodes reserves the right to make modifications, enhancements, improvements, corrections or other changes without further notice to this document and any product described herein. This document is written in English but may be translated into multiple languages for reference. Only the English version of this document is the final and determinative format released by Diodes.
8. Any unauthorized copying, modification, distribution, transmission, display or other use of this document (or any portion hereof) is prohibited. Diodes assumes no responsibility for any losses incurred by the customers or users or any third parties arising from any such unauthorized use.
9. This Notice may be periodically updated with the most recent version available at <https://www.diodes.com/about/company/terms-and-conditions/important-notice>

The Diodes logo is a registered trademark of Diodes Incorporated in the United States and other countries.
All other trademarks are the property of their respective owners.
© 2023 Diodes Incorporated. All Rights Reserved.

www.diodes.com

Looking for pricing, stock, or lifecycle information?

Click below to explore more details on WIN SOURCE:

 [View AP22615BWU-7 on WIN SOURCE](#)

 [Diodes Incorporated](#) Information

Optimize Your Supply Chain with WIN SOURCE Solutions

-  Global Sourcing Solution
-  Obsolete Management
-  Cost Control Management
-  Shortage Management
-  Alternative Solution
-  Excess Inventory Management