



**THE DATASHEET OF
DF11-26DS-2C**



DF11 Series

2.0mm Pitch, Double-Row Connector (UL/CSA Compliant)

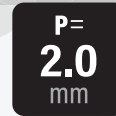

P=2.0 mm



Wide Variation



Friction-Lock

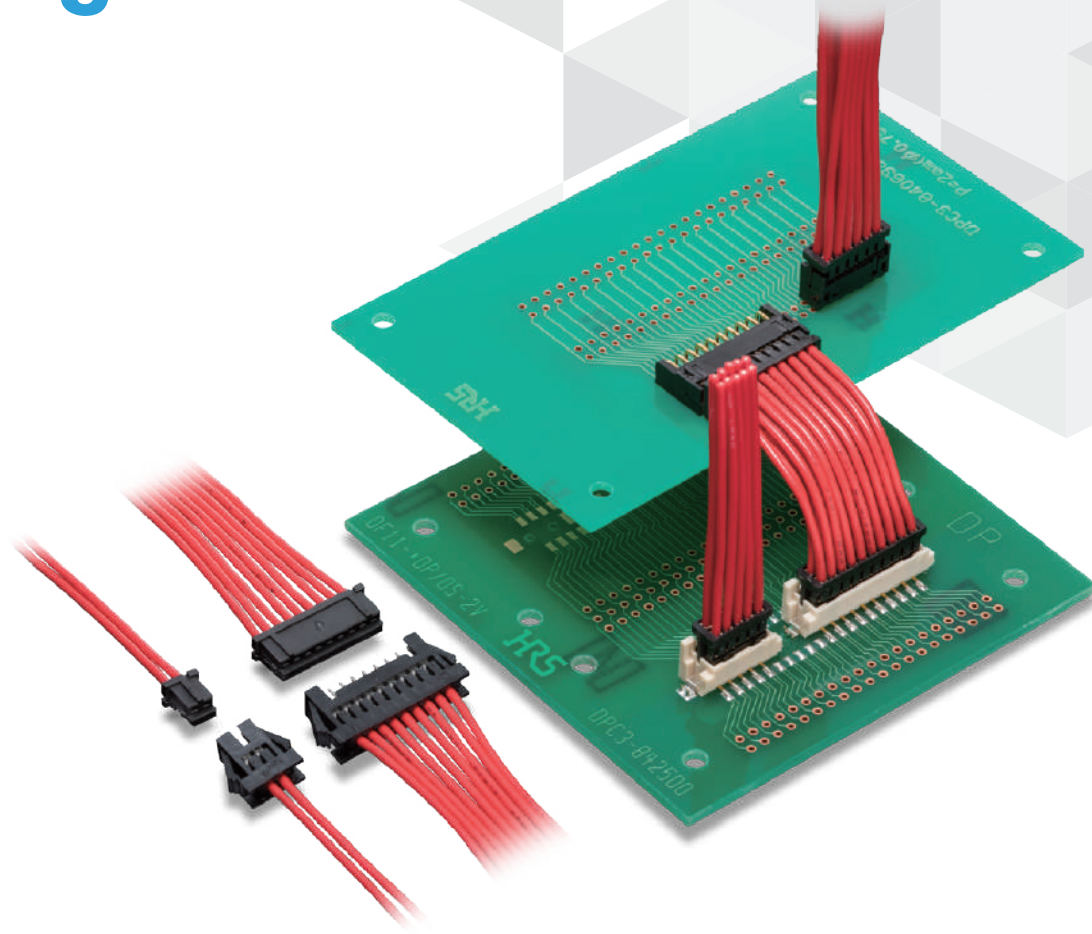

Jun.1.2024 Copyright 2024 HIROSE ELECTRIC CO., LTD. All Rights Reserved.



Features

1. Space-saving on Board

Double row contact arrangement with 2mm pitch has been condensed within a 5mm width. Double the number of signals can be secured in the same space as a conventional 2mm single-row connector.

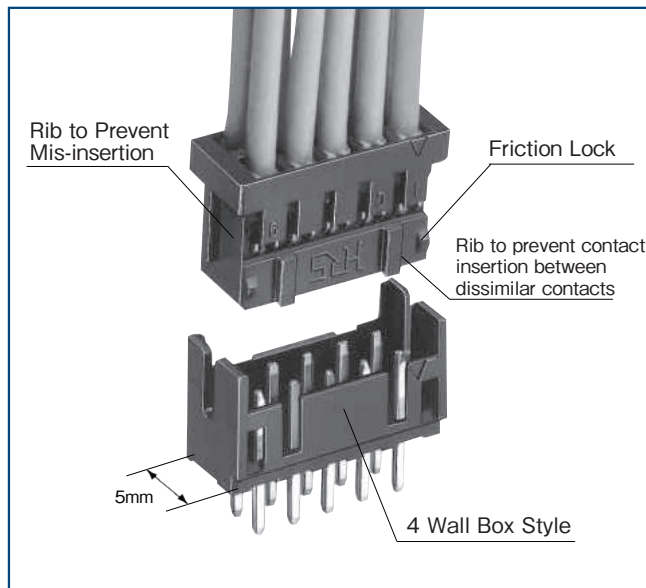

2. Wide Varieties

The connection method is crimping. Variations are available in cable-to-board, in-line, and board-to-board to expand PCB design freedom. Additionally, both gold and tin plating can be selected based on the application and SMT compatible products are also available.

3. Wide Applicable Wire Range

The double 2mm pitch rows are compact while enabling an applicable wire range of 22 to 30 AWG.

Applications

Business equipment such as copy machines, printers and so on.

Product Specifications

Ratings	Crimping		
	Rated Current (Note 1)	22 to 26 AWG 2A/pin	28 AWG 1A/pin
Rated Voltage	250V AC/DC		
Operating Temperature Range	-30 to +85°C (Note 2)		
Operating Humidity Range	40 to 80% (Note 3)		
Storage Temperature Range	-10 to +60°C (Note 4)		
Storage Humidity Range	40 to 70% (Note 4)		

UL, CSA Safety Standard Approved Specification			
Wire Size	22 AWG	24 to 28 AWG	30 AWG
Rated Current	2A/pin	1A/pin	0.5A/pin
Rated Voltage	30V AC/DC		

■ UL, CSA Safety Standard File No.

UL : E52653

CSA : LR95109

Item	Specification	Condition		
Insulation Resistance	1000M Ω Min.	500V DC		
Withstanding Voltage	No flashover or insulation breakdown.	650V AC for 1 min.		
Contact Resistance	30m Ω Max.	100mA		
Single Insertion/Extraction Force	0.3N (30gf) Min. 4.4N (450gf) Max.	Measured by the square steel pin at 0.5 ± 0.002 mm		
Vibration	No electrical discontinuity of 1μ s or more	Frequency : 10 to 55Hz, single amplitude of 0.75mm, 2 hours in each of the 3 directions.		
Humidity (Steady State)	Contact Resistance : 30m Ω Max. Insulation Resistance : 500M Ω Min.	96 hours at temperature of $40 \pm 2^\circ$ C and humidity of 90 to 95%		
Temperature Cycle	Contact Resistance : 30m Ω Max. Insulation Resistance : 1000M Ω Min.	(-55°C : 30 minutes \rightarrow 5 to 35°C : 10 minutes \rightarrow 85°C : 30 minutes \rightarrow 5 to 35°C : 10 minutes) 5 cycles		
Mating Durability	Contact Resistance : 30m Ω Max.	Tin Plated : 30 cycles, Gold Plated : 50 cycles		
Resistance to Soldering Heat	No deformation of components affecting performance.	Through Hole	Flow : 260°C for 10 seconds	Manual soldering : 300°C for 2 seconds
		SMT	Reflow : At the recommended temperature profile	Manual soldering : 300°C for 3 seconds

Note 1 : This is the maximum current rating while all pins are powered or used as all power lines.

When isolating power lines into multiple circuits, current ratings may go above the stated current ratings.

Please consult Hirose for details before doing this. Current rating of header is 2A.

Note 2 : Includes the temperature rise due to current flow.

Note 3 : The connector should be completely dry. (no condensation)

Note 4 : The term "storage" refers to the long-term storage condition of unused products before PCB mounting.

The operating temperature and humidity ranges apply while the connector is in a non-energized state, while in transport or after PCB mounting.

Note 5 : Information contained in this catalog represents general requirements for this Series.

Contact us for the drawings and specifications for a specific part number shown.

Material / Finish

Product Type	Part	Material	Finish	Remarks
Crimping Socket	Insulator	Polyamide	Black	UL94V-0
Crimping Contact for Socket	Contact	Phosphor Copper	Tin Plated or Gold Plated	-
Receptacle	Insulator	Polyamide	Black	UL94V-0
	Contact	Phosphor Copper	Tin Plated or Gold Plated	-
Pin Header	Insulator	Polyamide	Black	UL94V-0
	Contact	Brass	Tin Plated or Gold Plated	-
SMT Header	Insulator	Polyamide	Beige	UL94V-0
	Contact	Brass	Tin Plated or Gold Plated	-
	Retention Tab	Brass	Tin Plated	-
In-line Plug	Insulator	Polyamide	Black	UL94V-0
In-line Plug Crimping Contact	Contact	Phosphor Copper	Tin Plated or Gold Plated	-

Product Number Structure

Refer to the chart below when determining the product specifications from the product number.
Please select from the product numbers listed in this catalog when placing orders.

● Connector

DF11 - # DS - 2 C

① ② ③ ④ ⑤

① Series Name	DF11	⑤ Connection Form/ Contact Style	C : Crimping Socket DSA : Straight Through Hole DS : Right Angle Through Hole V : Straight SMT
② No. of Pos.	4 to 32		
③ Connector Type	DS : Double Row Socket DP : Double Row Pin Header DEP : Double Row In-line Plug		
④ Contact Pitch	2mm		

● Contact

DF11 - EP 2428 PCF A

① ② ③ ④

① Contact Type	EP : For In-line Plug	④ Plating Type	Blank : Tin Plated A : Gold Plated
② Applicable Wire Size	22 : 22 AWG 2428 : 24 to 28 AWG 30 : 30 AWG		
③ Contact Type/ Packaging Type	SCF : Socket Contact, Embossed Tape SC : Socket Contact, Bag PCF : Plug Contact, Embossed Tape PC : Plug Contact, Bag		

Crimping Socket



Shown Assembled with Cable

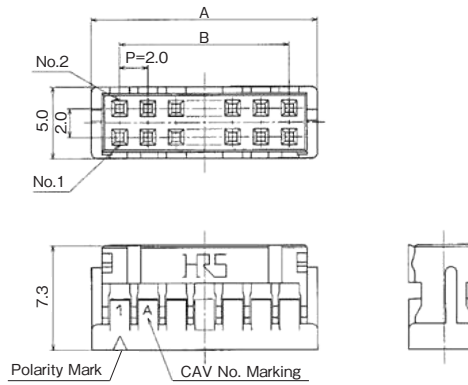

Unit : mm

Part No.	HRS No.	No. of Pos.	A	B	Purchase Unit
DF11-4DS-2C	CL0543-0568-6-00	4	6.0	2.0	100pcs per bag
DF11-6DS-2C	CL0543-0502-8-00	6	8.0	4.0	
DF11-8DS-2C	CL0543-0503-0-00	8	10.0	6.0	
DF11-10DS-2C	CL0543-0504-3-00	10	12.0	8.0	
DF11-12DS-2C	CL0543-0505-6-00	12	14.0	10.0	
DF11-14DS-2C	CL0543-0506-9-00	14	16.0	12.0	
DF11-16DS-2C	CL0543-0507-1-00	16	18.0	14.0	
DF11-18DS-2C	CL0543-0508-4-00	18	20.0	16.0	
DF11-20DS-2C	CL0543-0509-7-00	20	22.0	18.0	
DF11-22DS-2C	CL0543-0510-6-00	22	24.0	20.0	
DF11-24DS-2C	CL0543-0511-9-00	24	26.0	22.0	
DF11-26DS-2C	CL0543-0512-1-00	26	28.0	24.0	
DF11-28DS-2C	CL0543-0513-4-00	28	30.0	26.0	
DF11-30DS-2C	CL0543-0514-7-00	30	32.0	28.0	
DF11-32DS-2C	CL0543-0515-0-00	32	34.0	30.0	

Receptacle (Through Hole)



- Board Through-hole Diameter : $\phi 0.8^{+0.1}_0$
- Diameter of Board Hole for Kink Pin Securing : $\phi 0.8^{+0.05}_0$

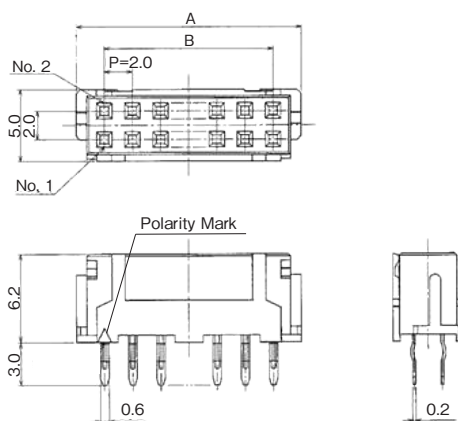

Unit : mm

Part No.	HRS No.	No. of Pos.	A	B	Purchase Unit
DF11-6DS-2DSA(##)	CL0543-0553-9-##	6	8.0	4.0	100pcs per bag
DF11-8DS-2DSA(##)	CL0543-0554-1-##	8	10.0	6.0	
DF11-10DS-2DSA(##)	CL0543-0555-4-##	10	12.0	8.0	
DF11-12DS-2DSA(##)	CL0543-0556-7-##	12	14.0	10.0	
DF11-14DS-2DSA(##)	CL0543-0557-0-##	14	16.0	12.0	
DF11-16DS-2DSA(##)	CL0543-0558-2-##	16	18.0	14.0	
DF11-18DS-2DSA(##)	CL0543-0559-5-##	18	20.0	16.0	
DF11-20DS-2DSA(##)	CL0543-0560-4-##	20	22.0	18.0	
DF11-22DS-2DSA(##)	CL0543-0561-7-##	22	24.0	20.0	
DF11-24DS-2DSA(##)	CL0543-0562-0-##	24	26.0	22.0	
DF11-26DS-2DSA(##)	CL0543-0563-2-##	26	28.0	24.0	
DF11-28DS-2DSA(##)	CL0543-0564-5-##	28	30.0	26.0	
DF11-30DS-2DSA(##)	CL0543-0565-8-##	30	32.0	28.0	
DF11-32DS-2DSA(##)	CL0543-0566-0-##	32	34.0	30.0	

[Specific No.] -##,(##)

(05) : Tin Plated

(06) : Gold Plated

Receptacle (SMT)



PCB Mounting Pattern



Note : If the shaded area has a pattern and is not treated with resist it may touch the connector contact.

Unit : mm

Tin Plated		Gold Plated		No. of Pos.	A	B	C	Purchase Unit
Part No.	HRS No.	Part No.	HRS No.					
DF11CZ-4DS-2V(22)	CL0543-2063-0-22	-	-	4	2.0	8.5	8.7	500pcs per reel
DF11CZ-6DS-2V(22)	CL0543-2064-3-22	DF11CZ-6DS-2V(52)	CL0543-2064-3-52	6	4.0	10.5	10.7	
DF11CZ-8DS-2V(22)	CL0543-2065-6-22	DF11CZ-8DS-2V(52)	CL0543-2065-6-52	8	6.0	12.5	12.7	
DF11CZ-10DS-2V(22)	CL0543-2066-9-22	DF11CZ-10DS-2V(52)	CL0543-2066-9-52	10	8.0	14.5	14.7	
DF11CZ-12DS-2V(22)	CL0543-2067-1-22	DF11CZ-12DS-2V(52)	CL0543-2067-1-52	12	10.0	16.5	16.7	
DF11CZ-14DS-2V(22)	CL0543-2068-4-22	DF11CZ-14DS-2V(52)	CL0543-2068-4-52	14	12.0	18.5	18.7	
DF11CZ-16DS-2V(22)	CL0543-2069-7-22	-	-	16	14.0	20.5	20.7	
DF11CZ-18DS-2V(22)	CL0543-2070-6-22	DF11CZ-18DS-2V(52)	CL0543-2070-6-52	18	16.0	22.5	22.7	
DF11CZ-20DS-2V(22)	CL0543-2071-9-22	DF11CZ-20DS-2V(52)	CL0543-2071-9-52	20	18.0	24.5	24.7	
DF11CZ-22DS-2V(22)	CL0543-2072-1-22	-	-	22	20.0	26.5	26.7	
DF11CZ-24DS-2V(22)	CL0543-2073-4-22	-	-	24	22.0	28.5	28.7	
DF11CZ-26DS-2V(22)	CL0543-2074-7-22	-	-	26	24.0	30.5	30.7	
DF11CZ-30DS-2V(22)	CL0543-2076-2-22	DF11CZ-30DS-2V(52)	CL0543-2076-2-52	30	28.0	34.5	34.7	

[Specific No.] -##, (##)

(22) : Tin Plated Embossed Tape Packaging (with Vacuum Pick-up Cap)

(52) : Gold Plated Embossed Tape Packaging (with Vacuum Pick-up Cap)

Note 1 : The 40pos. connector can only be combined with SMT products.

Note 2 : Embossed packaging products have the reel wrapped in polyethylene and include a desiccant.

Straight Pin Header



● Board Through-hole Diameter : $\phi 0.8^{+0.1}_0$



Unit : mm

Part No.	HRS No.	No. of Pos.	A	B	Purchase Unit (##) : (01)	Purchase Unit (##) : (08)	Purchase Unit (##) : (24)
DF11-4DP-2DSA(##)	CL0543-0517-5-##	4	6.0	2.0	100pcs per bag	100pcs per bag	81pcs per tube
DF11-6DP-2DSA(##)	CL0543-0518-8-##	6	8.0	4.0			61pcs per tube
DF11-8DP-2DSA(##)	CL0543-0519-0-##	8	10.0	6.0			49pcs per tube
DF11-10DP-2DSA(##)	CL0543-0520-0-##	10	12.0	8.0			40pcs per tube
DF11-12DP-2DSA(##)	CL0543-0521-2-##	12	14.0	10.0			34pcs per tube
DF11-14DP-2DSA(##)	CL0543-0522-5-##	14	16.0	12.0			30pc per tube
DF11-16DP-2DSA(##)	CL0543-0523-8-##	16	18.0	14.0			27pcs per tube
DF11-18DP-2DSA(##)	CL0543-0524-0-##	18	20.0	16.0			24pcs per tube
DF11-20DP-2DSA(##)	CL0543-0525-3-##	20	22.0	18.0			22pcs per tube
DF11-22DP-2DSA(##)	CL0543-0526-6-##	22	24.0	20.0			20pcs per tube
DF11-24DP-2DSA(##)	CL0543-0527-9-##	24	26.0	22.0			18pcs per tube
DF11-26DP-2DSA(##)	CL0543-0528-1-##	26	28.0	24.0			17pcs per tube
DF11-28DP-2DSA(##)	CL0543-0529-4-##	28	30.0	26.0			16pcs per tube
DF11-30DP-2DSA(##)	CL0543-0530-3-##	30	32.0	28.0			15pcs per tube
DF11-32DP-2DSA(##)	CL0543-0531-6-##	32	34.0	30.0			14pcs per tube

[Specific No.] -##,(##)
 (01) : Gold Plated
 (08) : Tin Plated
 (24) : Tin Plated

Right Angle Pin Header

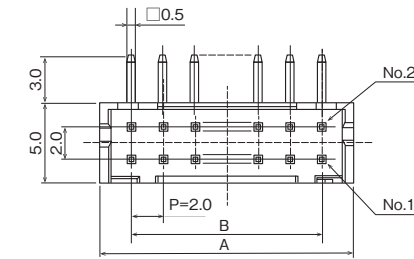

● Board Through-hole Diameter : $\phi 0.8^{+0.1}_0$

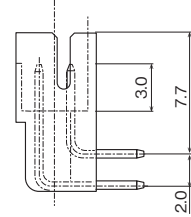
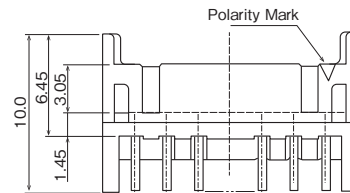

Unit : mm

Part No.	HRS No.	No. of Pos.	A	B	Purchase Unit
DF11-4DP-2DS(##)	CL0543-0533-1-##	4	6.0	2.0	81pcs per tube
DF11-6DP-2DS(##)	CL0543-0534-4-##	6	8.0	4.0	61pcs per tube
DF11-8DP-2DS(##)	CL0543-0535-7-##	8	10.0	6.0	48pcs per tube
DF11-10DP-2DS(##)	CL0543-0536-0-##	10	12.0	8.0	40pcs per tube
DF11-12DP-2DS(##)	CL0543-0537-2-##	12	14.0	10.0	34pcs per tube
DF11-14DP-2DS(##)	CL0543-0538-5-##	14	16.0	12.0	30pcs per tube
DF11-16DP-2DS(##)	CL0543-0539-8-##	16	18.0	14.0	27pcs per tube
DF11-18DP-2DS(##)	CL0543-0540-7-##	18	20.0	16.0	24pcs per tube
DF11-20DP-2DS(##)	CL0543-0541-0-##	20	22.0	18.0	22pcs per tube
DF11-22DP-2DS(##)	CL0543-0542-2-##	22	24.0	20.0	20pcs per tube
DF11-24DP-2DS(##)	CL0543-0543-5-##	24	26.0	22.0	18pcs per tube
DF11-26DP-2DS(##)	CL0543-0544-8-##	26	28.0	24.0	17pcs per tube
DF11-28DP-2DS(##)	CL0543-0545-0-##	28	30.0	26.0	16pcs per tube
DF11-30DP-2DS(##)	CL0543-0546-3-##	30	32.0	28.0	15pcs per tube
DF11-32DP-2DS(##)	CL0543-0547-6-##	32	34.0	30.0	14pcs per tube

[Specific No.] -##,(##)
 (24) : Tin Plated
 (52) : Gold Plated

Straight Pin Header (SMT)

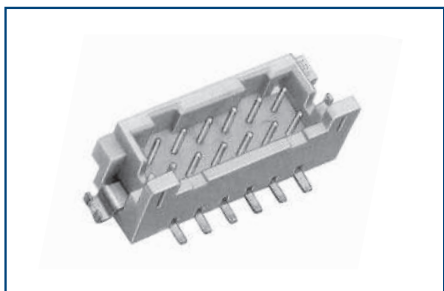

PCB Mounting Pattern

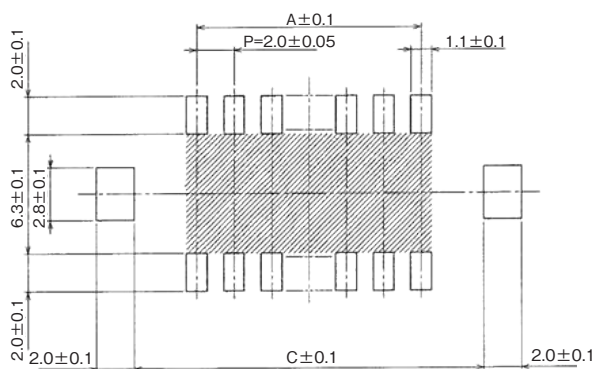

Note : If the shaded area has a pattern and is not treated with resist it may touch the connector contact.

Unit : mm

Tin Plated		Gold Plated		No. of Pos.	A	B	C	Purchase Unit
Part No.	HRS No.	Part No.	HRS No.					
DF11CZ-4DP-2V(27)	CL0543-2047-4-27	DF11C-4DP-2V(57)	CL0543-0682-1-57	4	2.0	8.5	8.7	500pcs per reel
DF11CZ-6DP-2V(27)	CL0543-2048-7-27	DF11C-6DP-2V(57)	CL0543-0683-4-57	6	4.0	10.5	10.7	
DF11CZ-8DP-2V(27)	CL0543-2049-0-27	DF11C-8DP-2V(57)	CL0543-0684-7-57	8	6.0	12.5	12.7	
DF11CZ-10DP-2V(27)	CL0543-2050-9-27	DF11C-10DP-2V(57)	CL0543-0685-0-57	10	8.0	14.5	14.7	
DF11CZ-12DP-2V(27)	CL0543-2051-1-27	DF11C-12DP-2V(57)	CL0543-0686-2-57	12	10.0	16.5	16.7	
DF11CZ-14DP-2V(27)	CL0543-2052-4-27	DF11C-14DP-2V(57)	CL0543-0687-5-57	14	12.0	18.5	18.7	
DF11CZ-16DP-2V(27)	CL0543-2053-7-27	DF11C-16DP-2V(57)	CL0543-0688-8-57	16	14.0	20.5	20.7	
DF11CZ-18DP-2V(27)	CL0543-2054-0-27	DF11C-18DP-2V(57)	CL0543-0689-0-57	18	16.0	22.5	22.7	
DF11CZ-20DP-2V(27)	CL0543-2055-2-27	DF11C-20DP-2V(57)	CL0543-0690-0-57	20	18.0	24.5	24.7	
DF11CZ-22DP-2V(27)	CL0543-2056-5-27	DF11C-22DP-2V(57)	CL0543-0691-2-57	22	20.0	26.5	26.7	
DF11CZ-24DP-2V(27)	CL0543-2057-8-27	DF11C-24DP-2V(57)	CL0543-0692-5-57	24	22.0	28.5	28.7	
DF11CZ-26DP-2V(27)	CL0543-2058-0-27	DF11C-26DP-2V(57)	CL0543-0693-8-57	26	24.0	30.5	30.7	
DF11CZ-28DP-2V(27)	CL0543-2059-3-27	DF11C-28DP-2V(57)	CL0543-0694-0-57	28	26.0	32.5	32.7	
DF11CZ-30DP-2V(27)	CL0543-2060-2-27	DF11C-30DP-2V(57)	CL0543-0695-3-57	30	28.0	34.5	34.7	
DF11CZ-32DP-2V(27)	CL0543-2061-5-27	DF11C-32DP-2V(57)	CL0543-0696-6-57	32	30.0	36.5	36.7	

[Specific No.] -##,(##)

(27) : Tin Plated Embossed Tape Packaging (with Vacuum Pick-up Cap)

(57) : Gold Plated Embossed Tape Packaging (with Vacuum Pick-up Cap)

Note 1 : Embossed packaging products have the reel wrapped in polyethylene and include a desiccant.

Note 2 : There may be blisters on the mold surfaces excluding the mating face during mounting. However this does not affect the product performance.

In-line Plug



Shown Assembled with Cable

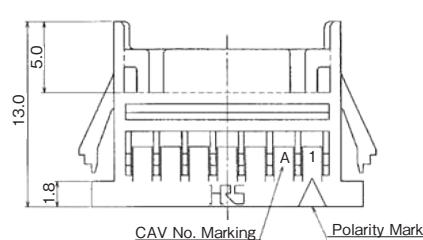
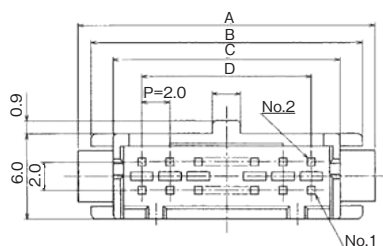

In-line Plug Panel Cutouts

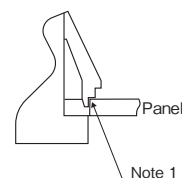
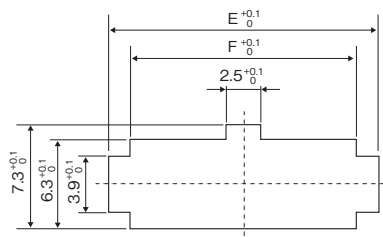

Note 1 : Please use the non-radius side for the panel hooking area.

Note 2 : Applicable panel thickness is 1.6 to 1.0mm

(Slight misalignment may occur for the panel thicknesses excluding 1.6 and 1.2mm.)

Unit : mm

Part No.	HRS No.	No. of Pos.	A	B	C	D	E	F	Purchase Unit
DF11-4DEP-2C	CL0543-0619-5-00	4	11.0	9.2	6.0	2.0	9.4	6.3	100pcs per bag
DF11-6DEP-2C	CL0543-0620-4-00	6	13.0	11.2	8.0	4.0	11.4	8.3	
DF11-8DEP-2C	CL0543-0621-7-00	8	15.0	13.2	10.0	6.0	13.4	10.3	
DF11-10DEP-2C	CL0543-0622-0-00	10	17.0	15.2	12.0	8.0	15.4	12.3	
DF11-12DEP-2C	CL0543-0623-2-00	12	19.0	17.2	14.0	10.0	17.4	14.3	
DF11-14DEP-2C	CL0543-0624-5-00	14	21.0	19.2	16.0	12.0	19.4	16.3	
DF11-16DEP-2C	CL0543-0625-8-00	16	23.0	21.2	18.0	14.0	21.4	18.3	
DF11-18DEP-2C	CL0543-0626-0-00	18	25.0	23.2	20.0	16.0	23.4	20.3	
DF11-20DEP-2C	CL0543-0627-3-00	20	27.0	25.2	22.0	18.0	25.4	22.3	
DF11-22DEP-2C	CL0543-0628-6-00	22	29.0	27.2	24.0	20.0	27.4	24.3	
DF11-24DEP-2C	CL0543-0629-9-00	24	31.0	29.2	26.0	22.0	29.4	26.3	
DF11-26DEP-2C	CL0543-0630-8-00	26	33.0	31.2	28.0	24.0	31.4	28.3	
DF11-28DEP-2C	CL0543-0631-0-00	28	35.0	33.2	30.0	26.0	33.4	30.3	
DF11-30DEP-2C	CL0543-0632-3-00	30	37.0	35.2	32.0	28.0	35.4	32.3	
DF11-32DEP-2C	CL0543-0633-6-00	32	39.0	37.2	34.0	30.0	37.4	34.3	

Crimping Contact for Socket

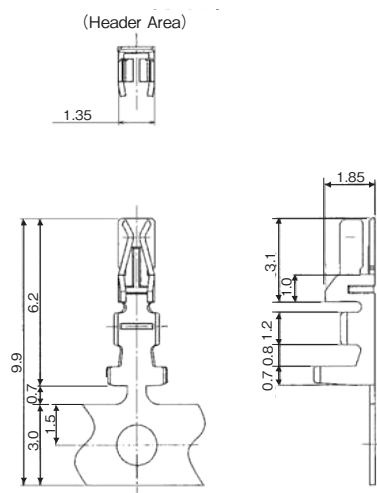

◆ Reel Contact (Applicable Tool : Applicator)

Part No.	HRS No.	Finish	Purchase Unit	Applicable Wire (Tin Plated Annealed Copper Wire) (Note 2)				
				UL	Wire Size	Standed Wire Conductor	Calculated Cross-section	Jacket Outer Dia.
DF11-22SCF	CL0543-0601-0-00	Tin Plated	10,000pcs per reel	1061	22 AWG	17 / 0.16mm	0.342mm ²	1.2 to 1.45mm
DF11-22SCFA(04)	CL0543-0603-5-04	Gold Plated		1061	22 AWG	17 / 0.16mm	0.342mm ²	1.2 to 1.45mm
DF11-2428SCF	CL0543-0500-2-00	Tin Plated		1061, 1007	24 AWG 26 AWG 28 AWG	11 / 0.16mm 7 / 0.16mm 7 / 0.127mm	0.221mm ² 0.141mm ² 0.089mm ²	0.9 to 1.45mm
DF11A-2428SCF (Note 1)	CL0543-0634-9-00	Tin Plated		1061, 1007	24 AWG 26 AWG 28 AWG	11 / 0.16mm 7 / 0.16mm 7 / 0.127mm	0.221mm ² 0.141mm ² 0.089mm ²	0.9 to 1.45mm
DF11-2428SCFA(04)	CL0543-0550-0-04	Gold Plated		1061, 1007	24 AWG 26 AWG 28 AWG	11 / 0.16mm 7 / 0.16mm 7 / 0.127mm	0.221mm ² 0.141mm ² 0.089mm ²	0.9 to 1.45mm
DF11-30SCF	CL0543-0605-0-00	Tin Plated		1061, 1007	30 AWG	7 / 0.1mm	0.055mm ²	0.75 to 1.2mm
DF11-30SCFA(04)	CL0543-0607-6-04	Gold Plated		1061, 1007	30 AWG	7 / 0.1mm	0.055mm ²	0.75 to 1.2mm

● Strip Length : 1.7 to 2.3mm

Note 1 : DF11A-2428SCF is the low insertion/extraction tin plated type.

Note 2 : Contact your Hirose representative if considering use of non-specified cables.

Note 3 : The strip length is a reference value. Adjust so that each dimension after crimping meets the specified value.

Refer to the Crimp Quality Standard (ETAD-H0773-00) for details.

◆ Loose Contact (Applicable Tool : Hand Crimping Tool)

Part No.	HRS No.	Finish	Purchase Unit	Applicable Wire (Tin Plated Annealed Copper Wire) (Note 2)				
				UL	Wire Size	Standed Wire Conductor	Calculated Cross-section	Jacket Outer Dia.
DF11-22SC	CL0543-0602-2-00	Tin Plated	100pcs per bag	1061	22 AWG	17 / 0.16mm	0.342mm ²	1.3mm
DF11-22SCA	CL0543-0604-8-00	Gold Plated		1061	22 AWG	17 / 0.16mm	0.342mm ²	1.3mm
DF11-2428SC	CL0543-0501-5-00	Tin Plated		1061	24 AWG	11 / 0.16mm	0.221mm ²	1.1mm
					26 AWG	7 / 0.16mm	0.141mm ²	1.0mm
DF11-2428SC	CL0543-0501-5-00	Tin Plated		1061	28 AWG	7 / 0.127mm	0.089mm ²	0.9mm
					1007	24 AWG	11 / 0.16mm	0.221mm ²
DF11-2428SC	CL0543-0501-5-00	Tin Plated		1007		26 AWG	7 / 0.16mm	0.141mm ²
					28 AWG	7 / 0.127mm	0.089mm ²	1.2mm
DF11A-2428SC (Note 1)	CL0543-0635-1-00	Tin Plated		1061	24 AWG	11 / 0.16mm	0.221mm ²	1.1mm
					26 AWG	7 / 0.16mm	0.141mm ²	1.0mm
DF11A-2428SC (Note 1)	CL0543-0635-1-00	Tin Plated	1061	28 AWG	7 / 0.127mm	0.089mm ²	0.9mm	
				1007	24 AWG	11 / 0.16mm	0.221mm ²	1.45mm
DF11-2428SCA	CL0543-0551-3-00	Gold Plated	1007		26 AWG	7 / 0.16mm	0.141mm ²	1.3mm
				28 AWG	7 / 0.127mm	0.089mm ²	1.2mm	
DF11-30SC	CL0543-0606-3-00	Tin Plated	1061	30 AWG	7 / 0.1mm	0.055mm ²	0.8mm	
DF11-30SCA	CL0543-0608-9-00	Gold Plated	1061	30 AWG	7 / 0.1mm	0.055mm ²	0.8mm	

Note 1 : DF11A-2428SC is the low insertion/extraction tin plated type.

Note 2 : When crimping using a hand crimping tool, only the above wires are applicable.

Note 3 : The strip length is a reference value. Adjust so that each dimension after crimping meets the specified value.

Refer to the Crimp Quality Standard (ETAD-H0773-00) for details.

Crimping Contact for In-line Plug



◆ Reel Contact (Applicable Tool : Applicator)

Part No.	HRS No.	Finish	Purchase Unit	Applicable Wire (Tin Plated Annealed Copper Wire) (Note 1)				
				UL	Wire Size	Standed Wire Conductor	Calculated Cross-section	Jacket Outer Dia.
DF11-EP2428PCF	CL0543-0615-4-00	Tin Plated	10,000pcs per reel	1061, 1007	24 AWG	11 / 0.16mm	0.221mm ²	0.9 to 1.45mm
					26 AWG	7 / 0.16mm	0.141mm ²	
					28 AWG	7 / 0.127mm	0.089mm ²	
DF11-EP2428PCFA	CL0543-0617-0-00	Gold Plated	10,000pcs per reel	1061, 1007	24 AWG	11 / 0.16mm	0.221mm ²	0.9 to 1.45mm
					26 AWG	7 / 0.16mm	0.141mm ²	
					28 AWG	7 / 0.127mm	0.089mm ²	

● Strip Length : 1.9 to 2.3mm

Note 1 : Contact your Hirose representative if considering use of non-specified cables.

Note 2 : The strip length is a reference value. Adjust so that each dimension after crimping meets the specified value.

Refer to the Crimp Quality Standard (ETAD-H0935-00) for details.

◆ Loose Contact (Applicable Tool : Hand Crimping Tool)

Part No.	HRS No.	Finish	Purchase Unit	Applicable Wire (Tin Plated Annealed Copper Wire) (Note 1)				
				UL	Wire Size	Standed Wire Conductor	Calculated Cross-section	Jacket Outer Dia.
DF11-EP2428PC	CL0543-0616-7-00	Tin Plated	100pcs per bag	1007	24 AWG	11 / 0.16mm	0.221mm ²	1.45mm
					26 AWG	7 / 0.16mm	0.141mm ²	1.3mm
					28 AWG	7 / 0.127mm	0.089mm ²	1.2mm
DF11-EP2428PCA	CL0543-0618-2-00	Gold Plated	100pcs per bag	1007	24 AWG	11 / 0.16mm	0.221mm ²	1.45mm
					26 AWG	7 / 0.16mm	0.141mm ²	1.3mm
					28 AWG	7 / 0.127mm	0.089mm ²	1.2mm

Note 1 : When crimping using a hand crimping tool, only the above wires are applicable.

Note 2 : The strip length is a reference value. Adjust so that each dimension after crimping meets the specified value.

Refer to the Crimp Quality Standard (ETAD-H0935-00) for details.

Embossed Carrier Tape Dimensions (JIS-C-0806 Standard)

● Straight Pin Header (SMT)

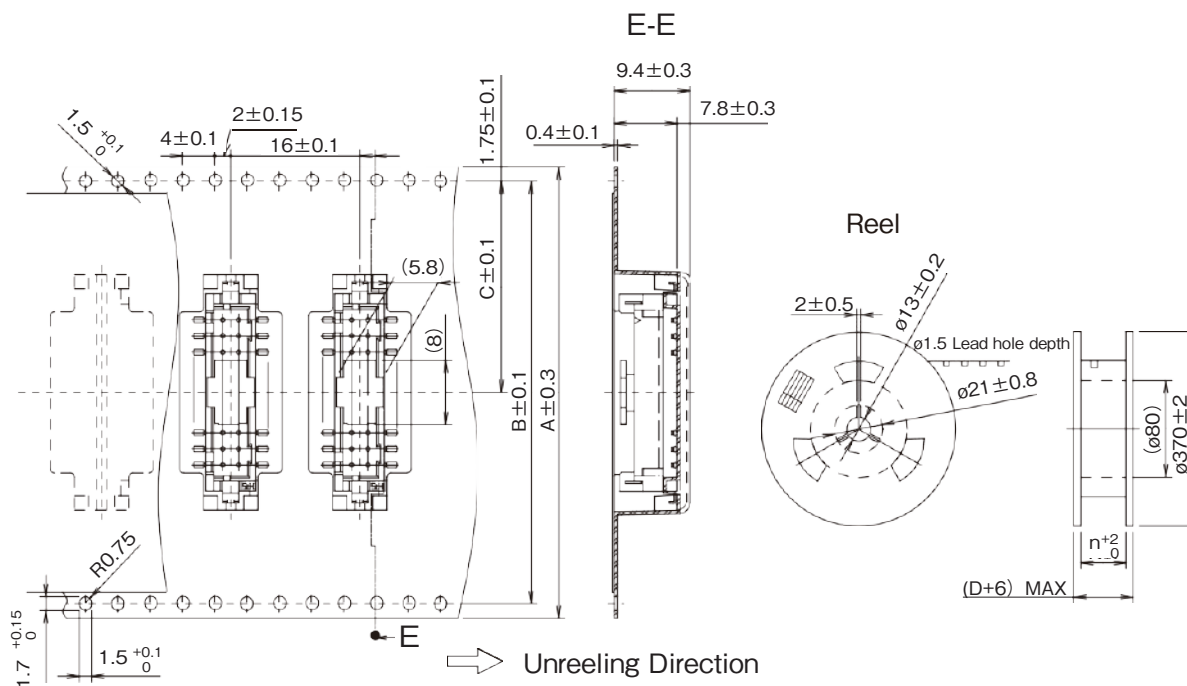

Unit : mm

Product Type	No. of Pos.	A	B	C	D
DF11CZ-##DP-2V(27) DF11C-##DP-2V(57)	4 to 8	24.0	-	11.5	24.4
	10 to 12	32.0	28.4	14.2	32.4
	14 to 22	44.0	40.4	20.2	44.4
	24 to 32	56.0	52.4	26.2	56.4
	40	72.0	68.4	34.2	72.4

Application Pattern

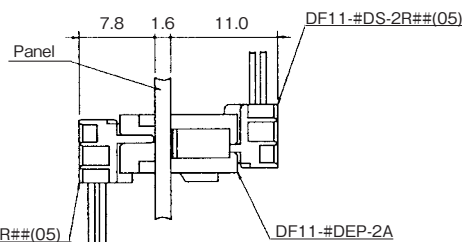
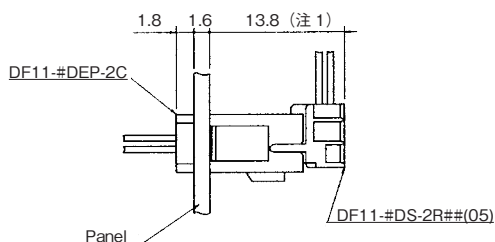
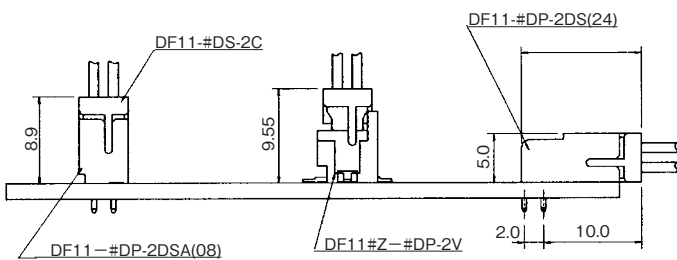

(Note 1) DF11-#DS-2C : 11.9

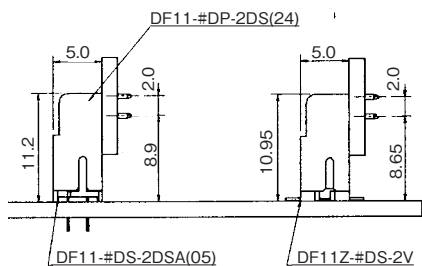
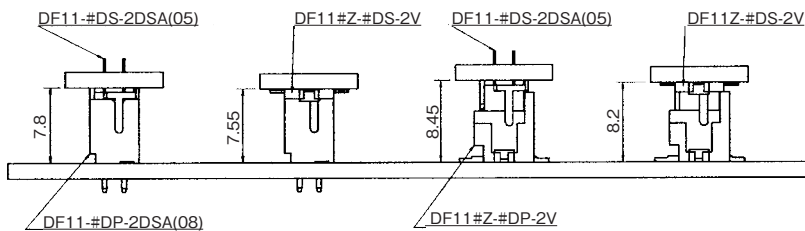

Jun. 1. 2024 Copyright 2024 HIROSE ELECTRIC CO., LTD. All Rights Reserved.

Applicable Crimping Tool

Type	Part No.	HRS No.	Applicable Contact
Applicator	AP105-DF11-22S	CL0901-4529-7-00	DF11-22SCF DF11-22SCFA(04)
	AP105-DF11-2428S	CL0901-4511-1-00	DF11-2428SCF DF11A-2428SCF DF11-2428SCFA(04)
	AP105-DF11-30S	CL0901-4532-1-00	DF11-30SCF DF11-30SCFA(04)
	AP105-DF11-EP2428P	CL0901-4528-4-00	DF11-EP2428PCF DF11-EP2428PCFA
Press	CM-105C	CL0901-0001-0-00	—
Hand Crimping Tool	HT801/DF11-22S(A)	CL0550-0407-5-00	DF11-22SC DF11-22SCA
	HT801/DF11-2428S(A)	CL0550-0403-4-00	DF11-2428SC DF11A-2428SC DF11-2428SCA
	HT801/DF11-30S(A)	CL0550-0408-8-00	DF11-30SC DF11-30SCA
	HT801/DF11-EP2428P(A)	CL0550-0409-0-00	DF11-EP2428PC DF11-EP2428PCA
Contact Extraction Tool	DF-C-PO(B)	CL0550-0179-2-00	DF11(A)-###SC(F)(A)(##) DF11-EP2428PC(F)(A)

Note 1 : Please do the crimping operations according to the table in the Crimp Quality Standard (ETAD-H0773-00, ETAD-H0935-00).

Note 2 : Problems with tools other than those specified by Hirose are outside the scope of warranty.

Crimping

■ Items required prior to starting crimping

The work-related documents shown below are required before starting harness assembly.

(The ● mark represents required documents.)

Please contact your Hirose sales representative if you do not have these documents.

Document Title	Description	Automatic Crimping Machine	Hand Crimping Tool	Remarks
Crimping Machine Main Unit Instruction Manual	Explanation of Main Press Machine Unit	●	-	Bundled with purchase of main press machine unit
Applicator Spare Parts Identification	Explanation for Applicator Installation	●	-	Bundled with purchase of applicator.
Crimp Conditions	Standard Crimp Height and Tensile Strength Values	●	-	
Crimp Quality Standards	Various Standards for Crimping Conditions	●	-	
Operating Instructions for Hand Tool	Crimp Height, Tensile Strength, and Other Inspection Items	-	●	Bundled with purchase of hand tool.
Harness Procedure Manual ETAD-H0965-00	Harness Procedure	●	●	Ask a Hirose sales personnel to provide them.

■ Tools

Use tools specified by Hirose for crimping.

*Crimping performed with tools other than those designated should be avoided as it may result in contact failure, disconnection of cable, etc.

*Operating instructions are available for the crimping machine and the applicator.

Be sure to carefully read the operating instructions manual before beginning work.

■ Applicable Cables

Check that the cables to be used are within the applicable range.

If you intend to use a cable other than those recommended, contact a sales representative.

[Precautions]

- Cables applicable to crimping connectors are tin-plated stranded soft-copper wire.
- Avoid crimping solid wire, wires with polyester threads or tin coated wires.
- Avoid crimping two cables together.
- The crimp height setting values (Note 1) may vary between tin-plated and gold-plated terminals even if the same electric wires are used.
- The crimp height setting values (Note 1) may vary depending on the difference in the core wire configuration even if the computed cross-sectional area is the same.

Note 1 : The crimp height is an important item that determines crimping quality. We execute crimping tests for each electric wire to ensure the optimal value for the crimp height with high precision, thereby ensuring optimal setup values.

Precautions

1. Recommended Temperature Profile (SMT)

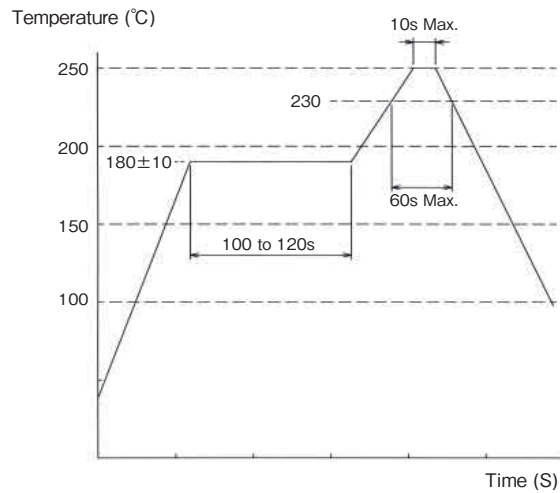

Note 1 : Up to 2 cycles of Reflow soldering are possible under the same conditions, provided that there is a return to normal temperature between the first and second cycle.

Note 2 : The temperature profile indicates the board surface temperature of the contact leads.

Note 3 : This reflow profile is for the connectors packaged in embossed tape (reel), with desiccant in the package. (Within 168 hours of opening)

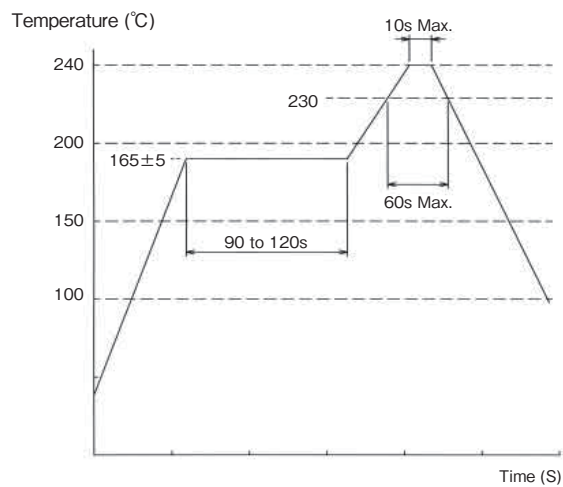

Note 4 : Reflow temperature conditions for embossed packaged products without desiccant and for embossed packaged products with desiccant that have been opened 168 hours ago or longer.

2. Recommended Manual Soldering Condition (SMT)	Soldering iron temperature: $290 \pm 10^{\circ}\text{C}$, Soldering time: Within 2 seconds
3. Recommended Screen Thickness (SMT)	0.15 to 0.2mm
4. Board Warpage (SMT)	Based on the both connector edges, 0.03mm Max. is allowed in the connector center area.
5. Recommended Soldering Condition (Through-hole)	Flow : $250 \pm 5^{\circ}\text{C}$ for 10 seconds Manual soldering : Soldering iron temperature $290 \pm 10^{\circ}\text{C}$ for 2 seconds
6. Cleaning Condition	Refer to the "Board-to-Wire Connector Guidelines".
7. Connection Condition	Refer to the "Board-to-Wire Connector Guidelines".
8. Precautions	<ul style="list-style-type: none"> ■ When inserting the crimp terminal into the IDC socket, do not insert diagonally in order to maintain performance reliability. ■ Refer to the DF11 Series Cable Assembly Procedure (ETAD-H0965-00), DF11#-##SC##(##) Crimp Quality Standard (ETAD-H0773-00), DF11#-EP###PC##(##) (ETAD-H0935-00) and Crimp Condition for the cable assembly procedures. ■ Please refrain from insertion and removal when not mounted to the board as it may result in damage or deformation of the contacts. ■ Do not remove the product by holding the cable as it may result in damage. ■ When soldering by hand do not apply flux that may result in flux rising. ■ There may be slight variation in the mold coloration based on production lot but this does not affect the product performance. ■ Black spots may appear on the mold resin but this does not affect the product quality.
9. Handling Instructions	<p>Refer to the following documents when handling this product.</p> <ul style="list-style-type: none"> ■ Crimp Quality Standard (ETAD-H0773-00, ETAD-H0935-00) ■ Cable Assembly Procedure (ETAD-H0965-00) ■ Board-to-Wire Connector Guidelines : ETAD-H1023-00

While Taking into Consideration

Specifications mentioned in this catalog are reference values.

When considering to order or use this product, please review the Drawing and Product Specifications sheets.

Use an appropriate cable when using the connector in combination with cables.

If considering usage of a non-specified cable, please contact your sales representative.

If assembly process is done by jigs & tools which are not identified by Hirose, the warranty of the product may be affected.

If considering usage for below mentioned applications, please contact your sales representative.

In cases where the application will demand a high level of reliability, such as automotive, medical instruments, public infrastructure, aerospace/defense etc. Hirose must review before assurance of reliability can be given.

HIROSE



HIROSE ELECTRIC CO.,LTD.

2-6-3 Nakagawa Chuoh, Tsuzuki-Ku, Yokohama-Shi 224-8540, JAPAN
<https://www.hirose.com>

Looking for pricing, stock, or lifecycle information?

Click below to explore more details on WIN SOURCE:

-  [View DF11-26DS-2C on WIN SOURCE](#)
-  [Hirose Electric Co Ltd Information](#)

Optimize Your Supply Chain with WIN SOURCE Solutions

-  Global Sourcing Solution
-  Obsolete Management
-  Cost Control Management
-  Shortage Management
-  Alternative Solution
-  Excess Inventory Management