



**THE DATASHEET OF  
DRDC3105E6-7**



**INTEGRATED RELAY, INDUCTIVE LOAD DRIVER**

**Description and Applications**

The DRDC3105 is an integrated solid-state DC relay driver that can switch inductive loads. It provides a robust driver interface by acting as a buffer stage between sensitive logic circuits and that of 3V to 6V DC inductive relay coils. With a low input drive current requirement, the DRDC3105 only has slight loading on the input circuitry and it will provide good transient isolation between output and input channels. The output switch is guaranteed by design to go open-circuit and fall into the off-state condition when input drive is lost or disconnected.

In the industry standard SOT23 and SOT26, the DRDC3105 comes as a single or dual die which can replace three to six individual discrete components within a single integrated package, including a Zener across the output. The Zener will clamp at 6.6V to sink inductive currents to ground which will reduce EMI noise in the system. By integrating the Zener, the DRDC3105 eliminates the need for an external free-wheeling diode and allows the driving of inductive loads such as relays, solenoids, incandescent lamps, and small DC motors in:

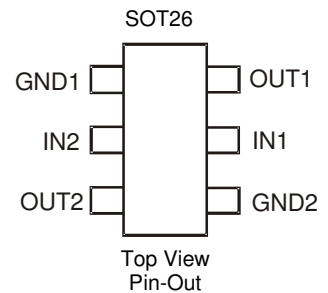
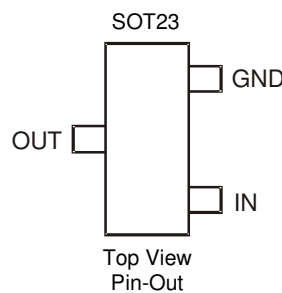
- Automotive: 5.0V Driven Relays, Lamp Drivers, Motor Controls
- Telecom Equipment: Modems, DSL, Cable (EMTA), Line Cards, IP-PBX, Analog Terminal Adaptors, End-User Telecom Equipment
- Desktop Computers, Printers, Photocopiers
- LCD & Plasma TVs, Set-Top Boxes
- Consumer Appliances, White Goods, Automated Door Control
- Industrial Equipment including Process Control, ATE Equipment
- Solar Inverters

**Mechanical Data**

- Case: SOT23 & SOT26
- Case Material: "Green" Plastic Molding Compound; UL Flammability Rating 94V-0
- Moisture Sensitivity: Level 1 per J-STD-020
- Terminals: Finish – Matte Tin Plated Leads, Solderable per MIL-STD-202, Method 208
- Weight: SOT23 = 0.008 grams (Approximate)  
SOT26 = 0.018 grams (Approximate)

**Features and Benefits**

- Inductive load driver capable of driving 3 to 6V DC coils
- Optimized to switch inductive loads from supply of 3 to 5V with the capability to drive coils up to 2.5W from a 5V rail
- Fully integrated into a single SOT23 or dual SOT26 package to minimize footprint area and reduce number of components
- Includes zener across output to reduce EMI noise
- Internal low saturation BJT to reduce power dissipation in driving high currents into the coil
- Output guaranteed to be in off-state condition during no input
- Near-Zero quiescent supply current in off-state condition with minimal leakage
- Rugged design and inherently robust by using solid-state BJT technology integrated into a single die
- ESD Protected up to 1kV on Human Body Model (HBM)
- **Totally Lead-Free & Fully RoHS Compliant (Notes 1 & 2)**
- **Halogen and Antimony Free. "Green" Device (Note 3)**
- **Qualified to AEC-Q101 Standards for High Reliability**

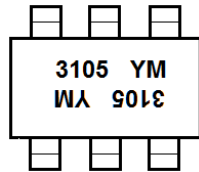
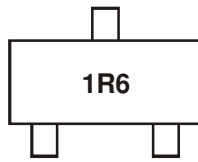


**Ordering Information** (Note 4)

Product	Package	Marking	Reel size (inches)	Tape width (mm)	Quantity per reel
DRDC3105F-7	SOT23	1R6	7	8	3,000
DRDC3105E6-7	SOT26	3105	7	8	3,000

- Notes:
1. No purposely added lead. Fully EU Directive 2002/95/EC (RoHS) & 2011/65/EU (RoHS 2) compliant.
  2. See [http://www.diodes.com/quality/lead\\_free.html](http://www.diodes.com/quality/lead_free.html) for more information about Diodes Incorporated's definitions of Halogen and Antimony free, "Green" and Lead-Free.
  3. Halogen and Antimony free "Green" products are defined as those which contain <900ppm bromine, <900ppm chlorine (<1500ppm total Br + Cl) and <1000ppm antimony compounds.
  4. For packaging details, go to our website at <http://www.diodes.com/products/packages.html>.

## Marking Information



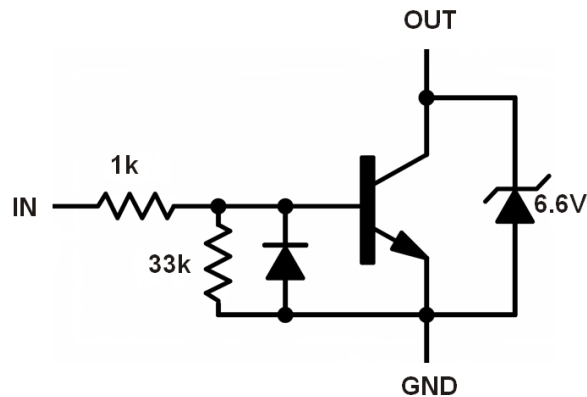
1R6 = SOT23, Product Type Marking Code  
 3105 = SOT26, Product Type Marking Code  
 YM = Date Code Marking  
 Y or Y = Year (ex: C = 2015)  
 M or M = Month (ex: 9 = September)

### Date Code Key

Year	2015	2016	2017	2018	2019	2020	2021	2022	2023	2024	2025
Code	C	D	E	F	G	H	I	J	K	L	M

Month	Jan	Feb	Mar	Apr	May	Jun	Jul	Aug	Sep	Oct	Nov	Dec
Code	1	2	3	4	5	6	7	8	9	O	N	D

## Internal Device Schematic



**Absolute Maximum Ratings** (@T<sub>A</sub> = +25 °C, unless otherwise specified.)

Characteristic	Symbol	Limit	Unit
Supply Voltage	V <sub>CC</sub>	6.0	V
Input Voltage (Forward)	V <sub>IN(FWD)</sub>	6.0	V
Input Voltage (Reverse)	V <sub>IN(REV)</sub>	-0.5	V
Output Sink Continuous Current	I <sub>O</sub>	500	mA
Repetitive Pulse Zener Energy Limit (Duty Cycle 0.01%)	E <sub>zpk</sub>	50	mJ

**Thermal Characteristics for DRDC3105F (SOT23)** (@T<sub>A</sub> = +25 °C, unless otherwise specified.)

Characteristic	Symbol	Value	Unit
Power Dissipation	P <sub>D</sub>	(Note 5) 310	mW
		(Note 6) 350	
Thermal Resistance, Junction to Ambient	R <sub>θJA</sub>	(Note 5) 403	°C/W
		(Note 6) 357	
Thermal Resistance, Junction to Leads	R <sub>θJL</sub>	350	°C/W
Operating and Storage Temperature Range	T <sub>J</sub> , T <sub>STG</sub>	-55 to +150	°C

**Thermal Characteristics for DRDC3105E6 (SOT26)** (@T<sub>A</sub> = +25 °C, unless otherwise specified.)

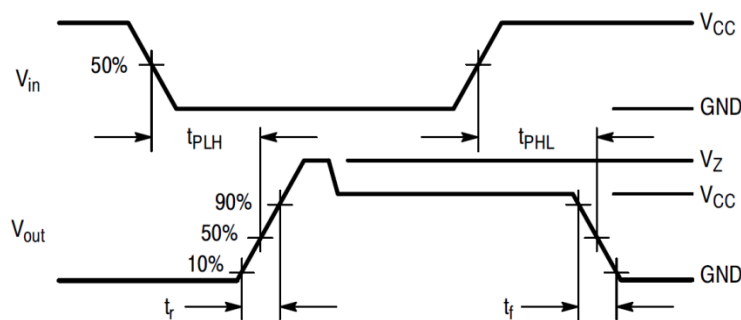
Characteristic	Symbol	Value	Unit
Power Dissipation Linear Derating Factor	P <sub>D</sub>	(Notes 7 & 9) 0.9	W mW/°C
		(Notes 7 & 10) 7.2	
		(Notes 8 & 10) 1.1	
		(Notes 8 & 10) 8.8	
Thermal Resistance, Junction to Ambient	R <sub>θJA</sub>	(Notes 7 & 9) 1.7	°C/W
		(Notes 7 & 10) 13.6	
		(Notes 8 & 10) 139	
Thermal Resistance, Junction to Leads	R <sub>θJL</sub>	113	°C/W
Operating and Storage Temperature Range	T <sub>J</sub> , T <sub>STG</sub>	73	°C
		100	°C/W
		-55 to +150	°C

- Notes:
5. For a device mounted on minimum recommended pad layout 1oz weight copper that is on a single-sided FR4 PCB; device is measured under still air conditions whilst operating in a steady-state.
  6. Same as Note 5, except the device is mounted on 15mm X 15mm 1oz copper.
  7. Same as Note 5, except the device is mounted on 25mm X 25mm 1oz copper.
  8. Same as Note 7, except the device is measured at < 5 seconds.
  9. For a device with one active die.
  10. For a device with two die running at equal power.
  11. Thermal resistance from junction to solder-point (at the end of the "OUT" lead).

**Electrical Characteristics** (@T<sub>A</sub> = +25 °C, unless otherwise specified.)

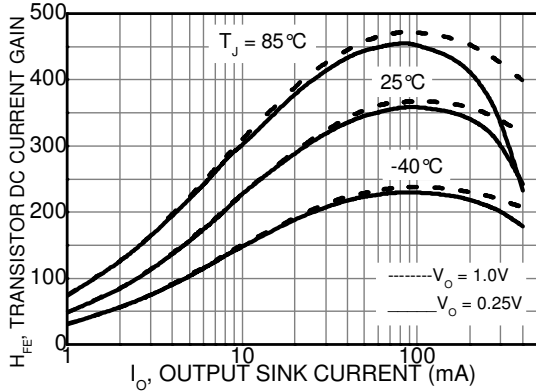
Characteristic	Symbol	Min	Typ	Max	Unit	Test Condition
<b>OFF CHARACTERISTICS</b>						
Output Zener Breakdown Voltage	BV <sub>(out)</sub> BV <sub>(-out)</sub>	6.2 -	6.6 0.67	7.0 -	V	@ I <sub>T</sub> = 10 mA Pulse
Output Leakage Current @ 0 Input Voltage	I <sub>OO</sub>	— —	— —	0.1 30	μA	V <sub>O</sub> = 5.5 V, T <sub>A</sub> = +25 °C V <sub>O</sub> = 5.5 V, T <sub>A</sub> = +85 °C
“ON” State Input Voltage (Note 12)	V <sub>in(on)</sub>	—	0.99	1.5	V	I <sub>O</sub> = 100 mA, V <sub>O</sub> = 150mV
“OFF” State Input Voltage (Note 13)	V <sub>in(off)</sub>	400	540	—	mV	I <sub>O</sub> = 100 μA, V <sub>O</sub> = 4.9V
<b>ON CHARACTERISTICS</b>						
Input Bias Current (H <sub>FE</sub> Limited)	I <sub>in</sub>	—	0.7	1.6	mA	I <sub>O</sub> = 250 mA, V <sub>O</sub> = 0.25V
Output Saturation Voltage	V <sub>O(sat)</sub>	—	125	160	mV	I <sub>O</sub> = 250 mA, I <sub>in</sub> = 1.5 mA
Output Sink Current – Continuous	I <sub>O(on)</sub>	250	430	—	mA	V <sub>CE</sub> = 0.25 V, I <sub>in</sub> = 1.5 mA
<b>SWITCHING CHARACTERISTICS</b> (Refer to Figure 1)						
Propagation Delay Times:						
High to Low Propagation Delay; (5.0V 74HC04)	t <sub>PHL</sub>	—	20.4	—	ns	—
Low to High Propagation Delay; (5.0V 74HC04)	t <sub>PLH</sub>	—	1.43	—	μs	—
High to Low Propagation Delay; 13 (3.0V 74HC04)	t <sub>PHL</sub>	—	32.2	—	ns	—
Low to High Propagation Delay; 13 (3.0V 74HC04)	t <sub>PLH</sub>	—	760	—	ns	—
High to Low Propagation Delay; 14 (5.0V 74LS04)	t <sub>PHL</sub>	—	25.3	—	ns	—
Low to High Propagation Delay; 14 (5.0V 74LS04)	t <sub>PLH</sub>	—	2.57	—	μs	—
Transition Times:						
Fall Time; (5.0V 74HC04)	t <sub>f</sub>	—	12.5	—	ns	—
Rise Time; (5.0V 74HC04)	t <sub>r</sub>	—	411	—	ns	—
Fall Time; 13 (3.0V 74HC04)	t <sub>f</sub>	—	21.1	—	ns	—
Rise Time; 13 (3.0V 74HC04)	t <sub>r</sub>	—	220	—	ns	—
Fall Time; 14 (5.0V 74LS04)	t <sub>f</sub>	—	15.1	—	ns	—
Rise Time; 14 (5.0V 74LS04)	t <sub>r</sub>	—	849	—	ns	—

Notes: 12. The device is guaranteed to be in “ON” state with V<sub>in(on)</sub> above 1.5V.  
13. The device is guaranteed to be in “OFF” state with V<sub>in(off)</sub> below 400mV.

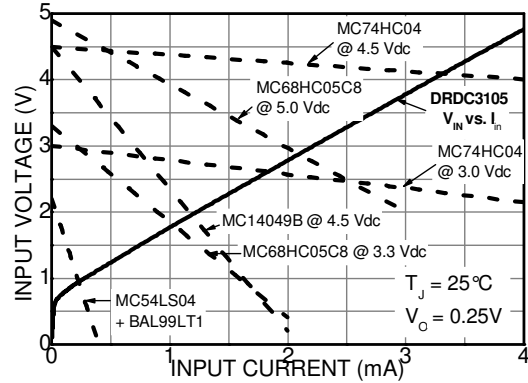


**Figure 1. Switching Waveforms**

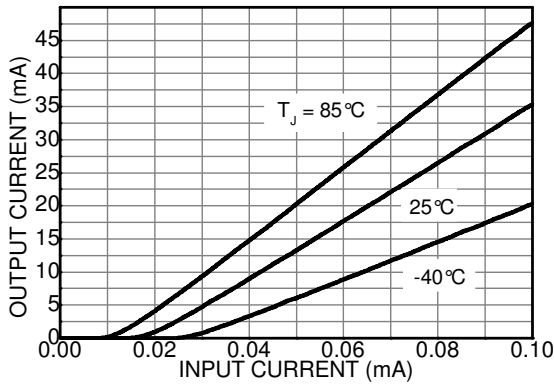
**Typical Electrical Characteristics** (@T<sub>A</sub> = +25°C, unless otherwise specified.)



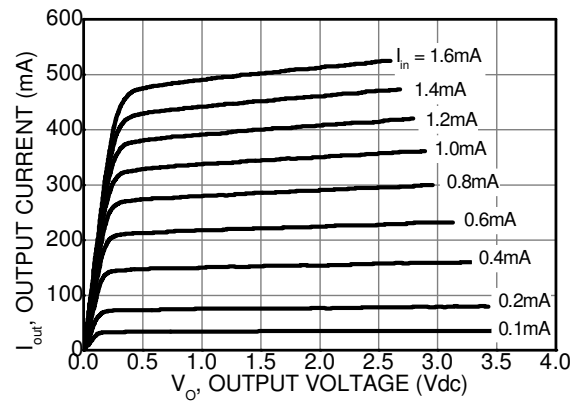
**Figure 2. Transistor DC Current Gain**



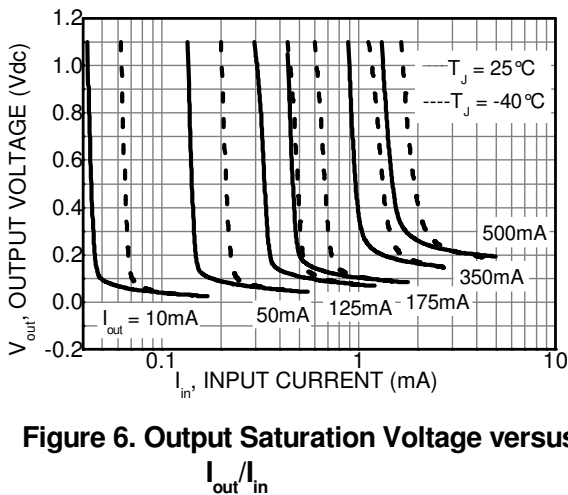
**Figure 3. Input V-I Requirement Compared to Possible Source Logic Outputs**



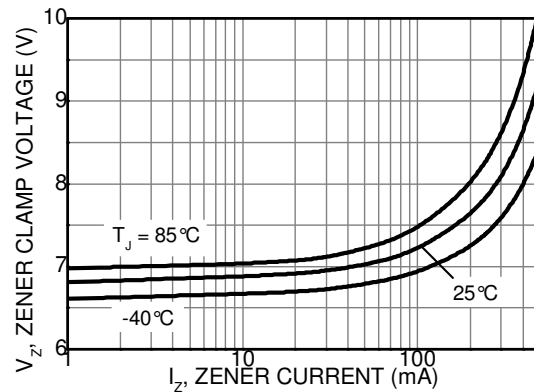
**Figure 4. Threshold Effects**



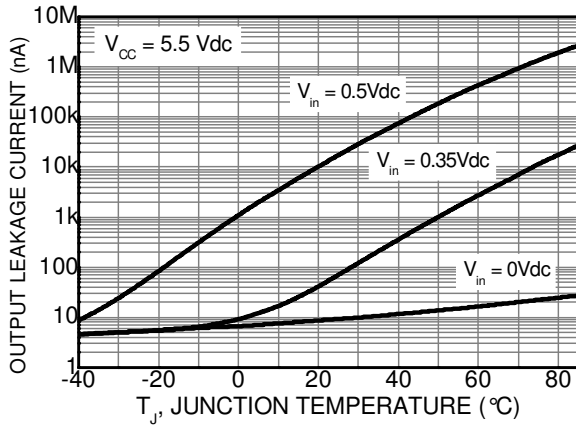
**Figure 5. Transistor Output V-I Characteristic**



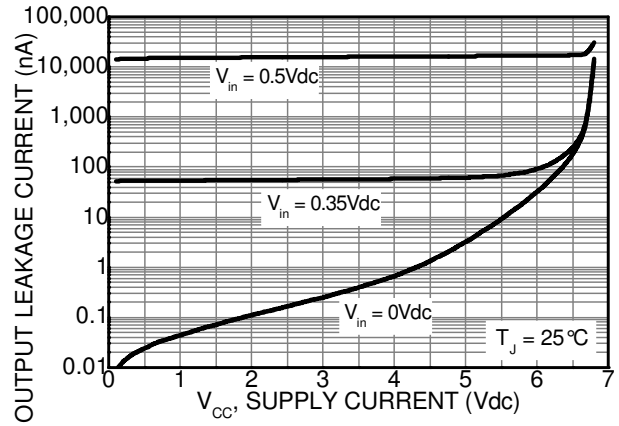
**Figure 6. Output Saturation Voltage versus  $I_{out}/I_{in}$**



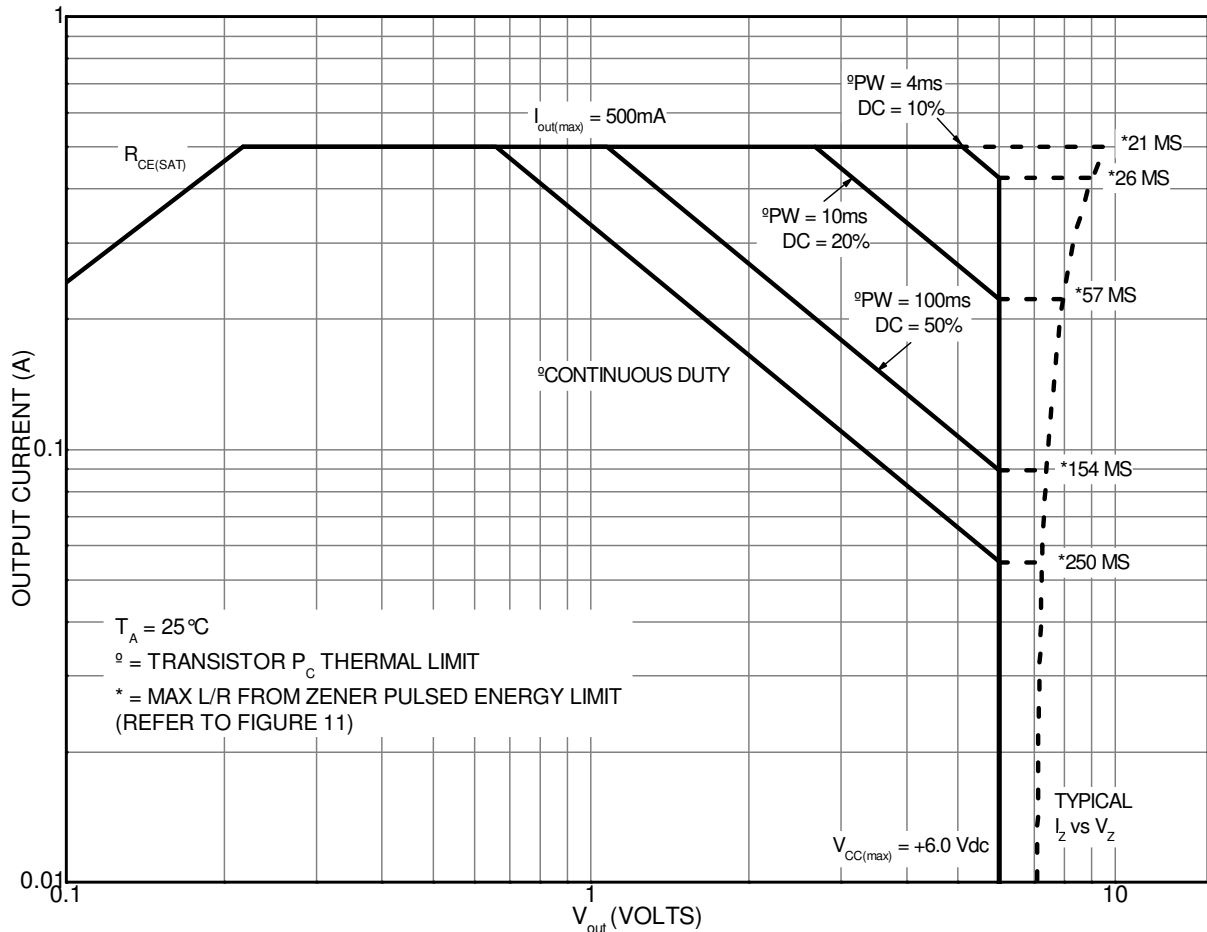
**Figure 7. Zener Clamp Voltage versus Zener Current**



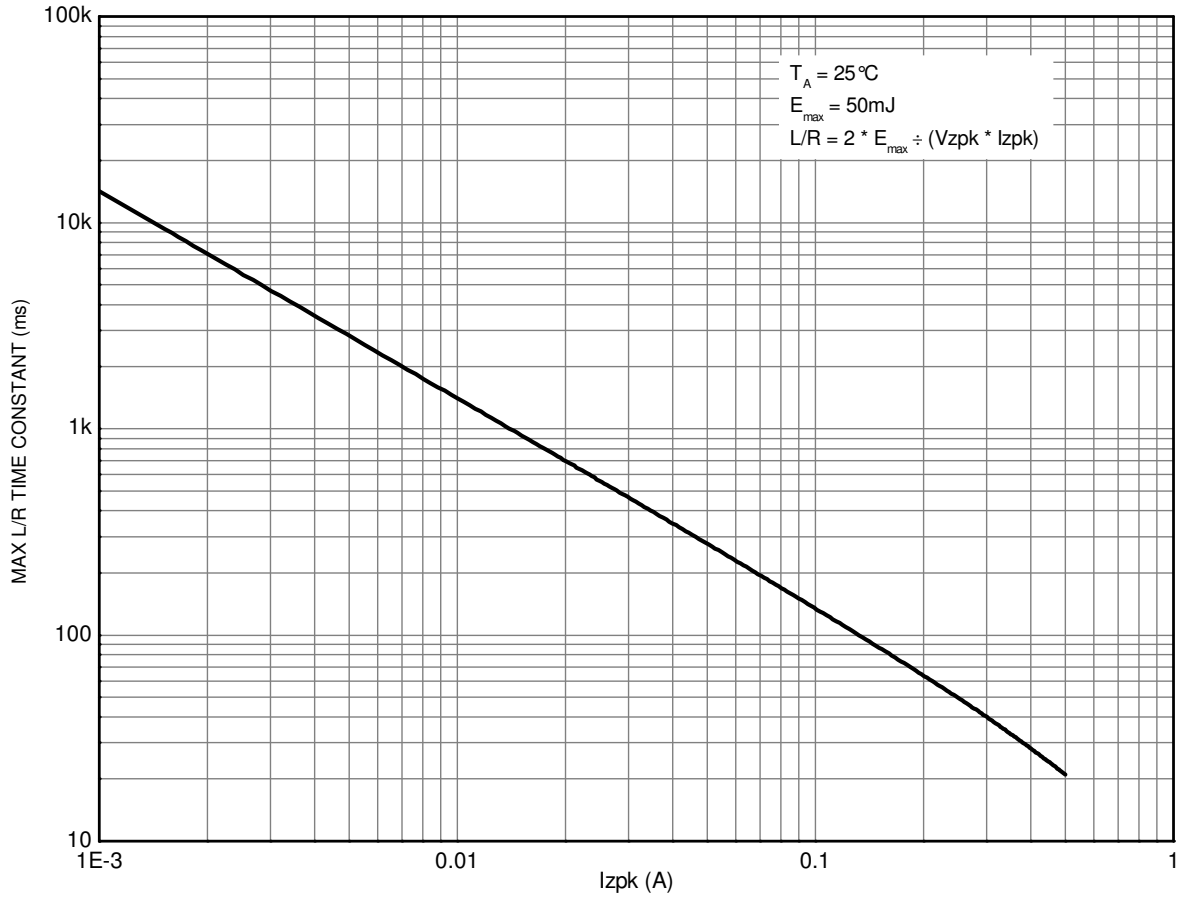
**Figure 8. Output Leakage Current versus Temperature**



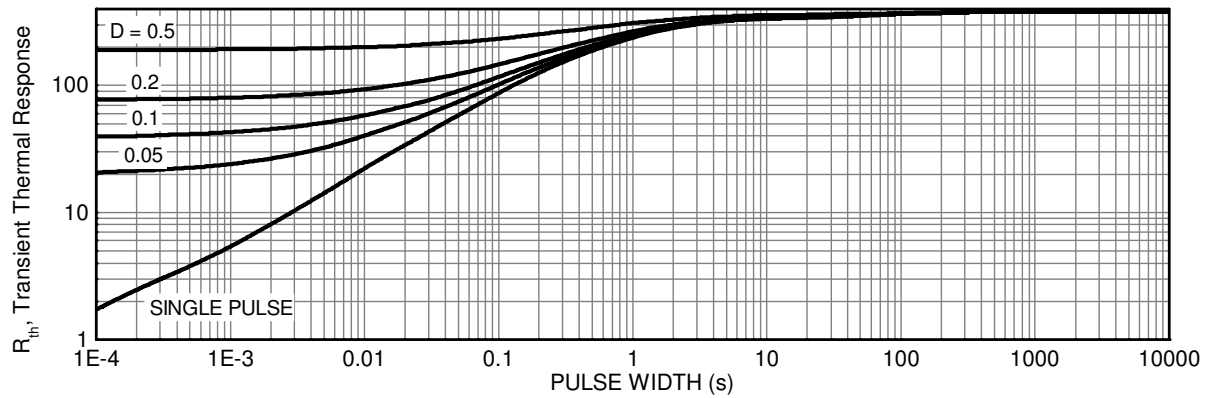
**Figure 9. Output Leakage Current versus Supply Voltage**



**Figure 10. Safe Operating Area**



**Figure 11. Zener Repetitive Pulse Energy Limit on L/R Time Constant**

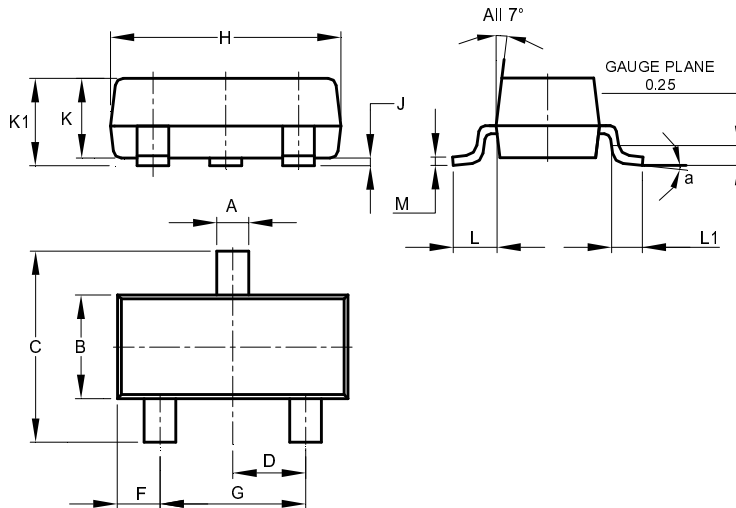


**Figure 12. Transient Thermal Response**

## Package Outline Dimensions

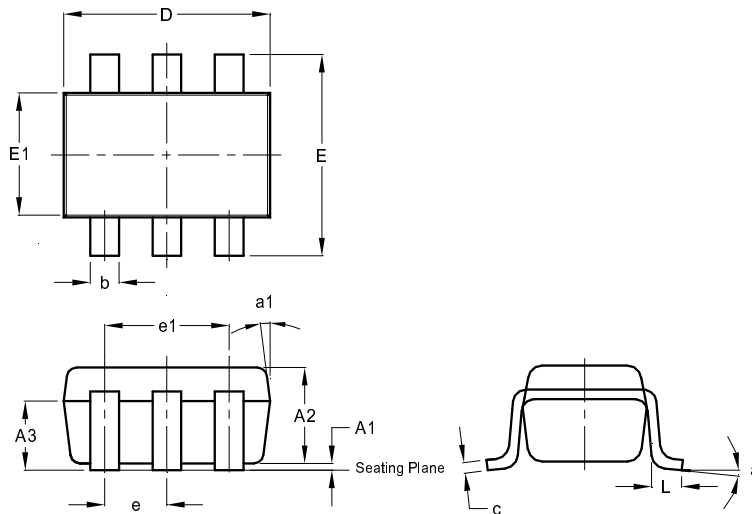
Please see AP02002 at <http://www.diodes.com/datasheets/ap02002.pdf> for the latest version.

Package Type: SOT23



SOT23			
Dim	Min	Max	Typ
A	0.37	0.51	0.40
B	1.20	1.40	1.30
C	2.30	2.50	2.40
D	0.89	1.03	0.915
F	0.45	0.60	0.535
G	1.78	2.05	1.83
H	2.80	3.00	2.90
J	0.013	0.10	0.05
K	0.890	1.00	0.975
K1	0.903	1.10	1.025
L	0.45	0.61	0.55
L1	0.25	0.55	0.40
M	0.085	0.150	0.110
a	8°		
All Dimensions in mm			

Package Type: SOT26

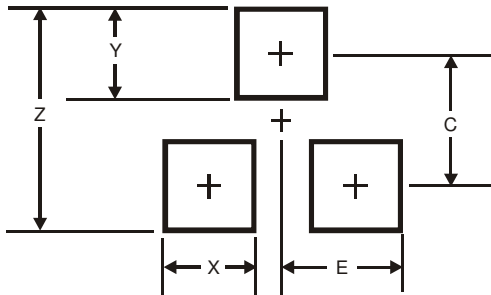


SOT26			
Dim	Min	Max	Typ
A1	0.013	0.10	0.05
A2	1.00	1.30	1.10
A3	0.70	0.80	0.75
b	0.35	0.50	0.38
c	0.10	0.20	0.15
D	2.90	3.10	3.00
e	-	-	0.95
e1	-	-	1.90
E	2.70	3.00	2.80
E1	1.50	1.70	1.60
L	0.35	0.55	0.40
a	-	-	8°
a1	-	-	7°
All Dimensions in mm			

## Suggested Pad Layout

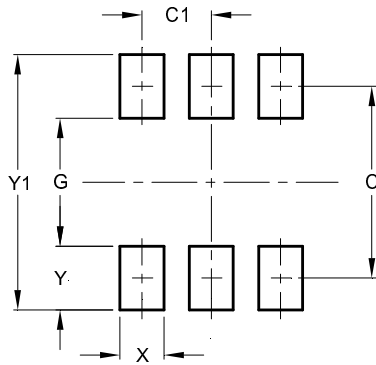
Please see AP02001 at <http://www.diodes.com/datasheets/ap02001.pdf> for the latest version.

Package Type: SOT23



Dimensions	Value (in mm)
Z	2.9
X	0.8
Y	0.9
C	2.0
E	1.35

Package Type: SOT26



Dimensions	Value (in mm)
C	2.40
C1	0.95
G	1.60
X	0.55
Y	0.80
Y1	3.20

#### IMPORTANT NOTICE

DIODES INCORPORATED MAKES NO WARRANTY OF ANY KIND, EXPRESS OR IMPLIED, WITH REGARDS TO THIS DOCUMENT, INCLUDING, BUT NOT LIMITED TO, THE IMPLIED WARRANTIES OF MERCHANTABILITY AND FITNESS FOR A PARTICULAR PURPOSE (AND THEIR EQUIVALENTS UNDER THE LAWS OF ANY JURISDICTION).

Diodes Incorporated and its subsidiaries reserve the right to make modifications, enhancements, improvements, corrections or other changes without further notice to this document and any product described herein. Diodes Incorporated does not assume any liability arising out of the application or use of this document or any product described herein; neither does Diodes Incorporated convey any license under its patent or trademark rights, nor the rights of others. Any Customer or user of this document or products described herein in such applications shall assume all risks of such use and will agree to hold Diodes Incorporated and all the companies whose products are represented on Diodes Incorporated website, harmless against all damages.

Diodes Incorporated does not warrant or accept any liability whatsoever in respect of any products purchased through unauthorized sales channel. Should Customers purchase or use Diodes Incorporated products for any unintended or unauthorized application, Customers shall indemnify and hold Diodes Incorporated and its representatives harmless against all claims, damages, expenses, and attorney fees arising out of, directly or indirectly, any claim of personal injury or death associated with such unintended or unauthorized application.

Products described herein may be covered by one or more United States, international or foreign patents pending. Product names and markings noted herein may also be covered by one or more United States, international or foreign trademarks.

This document is written in English but may be translated into multiple languages for reference. Only the English version of this document is the final and determinative format released by Diodes Incorporated.

#### LIFE SUPPORT

Diodes Incorporated products are specifically not authorized for use as critical components in life support devices or systems without the express written approval of the Chief Executive Officer of Diodes Incorporated. As used herein:

A. Life support devices or systems are devices or systems which:

1. are intended to implant into the body, or
2. support or sustain life and whose failure to perform when properly used in accordance with instructions for use provided in the labeling can be reasonably expected to result in significant injury to the user.

B. A critical component is any component in a life support device or system whose failure to perform can be reasonably expected to cause the failure of the life support device or to affect its safety or effectiveness.



Customers represent that they have all necessary expertise in the safety and regulatory ramifications of their life support devices or systems, and acknowledge and agree that they are solely responsible for all legal, regulatory and safety-related requirements concerning their products and any use of Diodes Incorporated products in such safety-critical, life support devices or systems, notwithstanding any devices- or systems-related information or support that may be provided by Diodes Incorporated. Further, Customers must fully indemnify Diodes Incorporated and its representatives against any damages arising out of the use of Diodes Incorporated products in such safety-critical, life support devices or systems.

Copyright © 2015, Diodes Incorporated

[www.diodes.com](http://www.diodes.com)

## Looking for pricing, stock, or lifecycle information?

Click below to explore more details on WIN SOURCE:

-  [View DRDC3105E6-7 on WIN SOURCE](#)
-  [Diodes Incorporated Information](#)

## Optimize Your Supply Chain with WIN SOURCE Solutions

-  Global Sourcing Solution
-  Obsolete Management
-  Cost Control Management
-  Shortage Management
-  Alternative Solution
-  Excess Inventory Management