



**THE DATASHEET OF  
DPX315950DT-5006C1**



# Multilayer Diplexers, DPX Series

## DPX161990DT-8003B1

### SHAPES AND DIMENSIONS/CIRCUIT

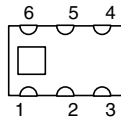
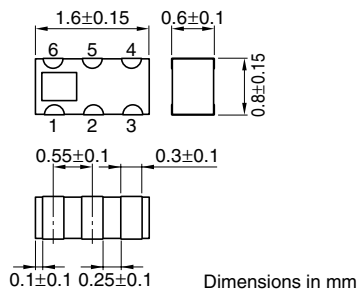

### TERMINAL FUNCTIONS

1	GND
2	ANT
3	GND
4	HIGH
5	GND
6	LOW

### RECOMMENDED PCB PATTERN

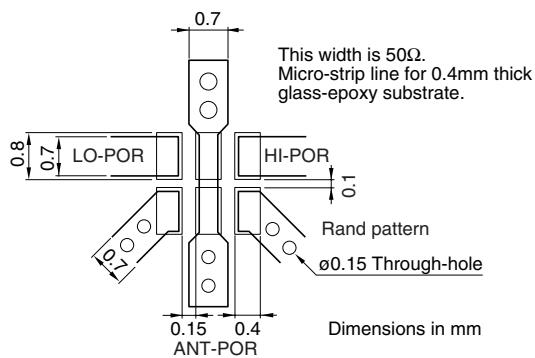

### ELECTRICAL CHARACTERISTICS

Item	Port	Frequency range	Minimum value	Typical value	Maximum value
Insertion loss	Lo-band	824 to 960MHz	(dB) —	—	0.7
	Hi-band	1710 to 1990MHz	(dB) —	—	0.85
Return loss	ANT	824 to 960MHz	(dB) 10.0	—	—
	ANT	1710 to 1990MHz	(dB) 10.0	—	—
Attenuation	Hi-band	824 to 960MHz	(dB) 17.0	—	—
	Lo-band	1710 to 1990MHz	(dB) 15.0	—	—
Temperature range	Operating	(°C)	−40	—	+85°C
	Storage	(°C)	−40	—	+85°C

• Ta: +25°C

### FREQUENCY CHARACTERISTICS

#### Lo-BAND PORT S21

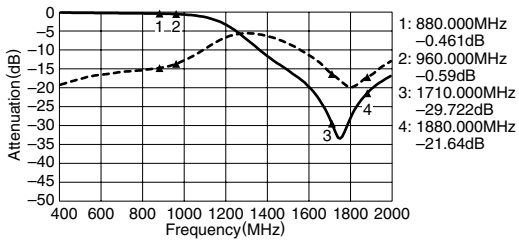

#### Hi-BAND PORT S31

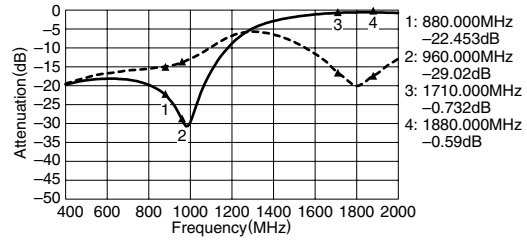

#### COMMON PORT RETURN LOSS S11

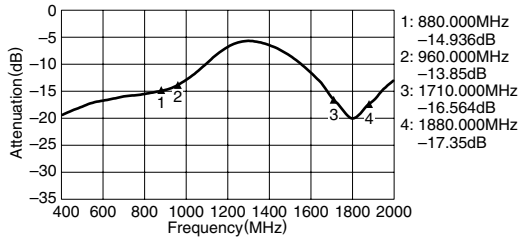

#### ISORATION S23

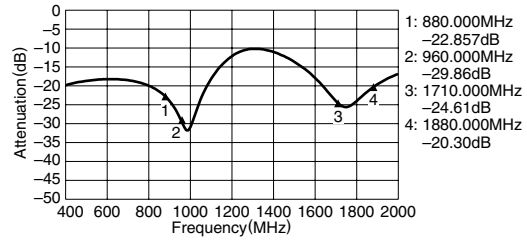

#### Lo-BAND PORT RETURN LOSS S22

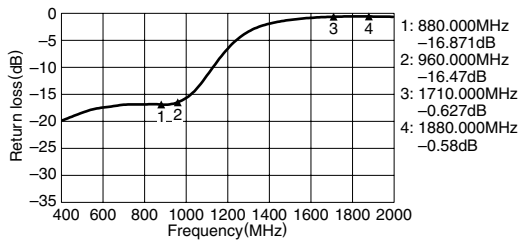

#### Hi-PORT RETURN LOSS S33

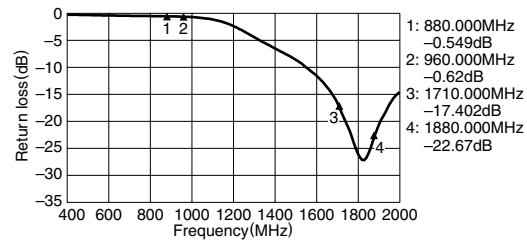

### SMITH CHART

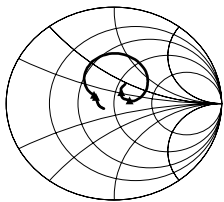

S11

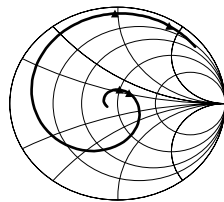

S22

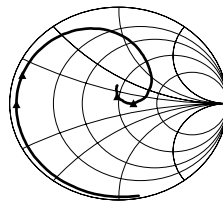

S33

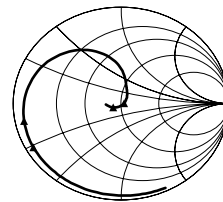

S21

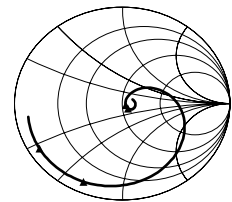

S31

# Multilayer Diplexers, DPX Series

## DPX201578DT-4017A1

### SHAPES AND DIMENSIONS/CIRCUIT

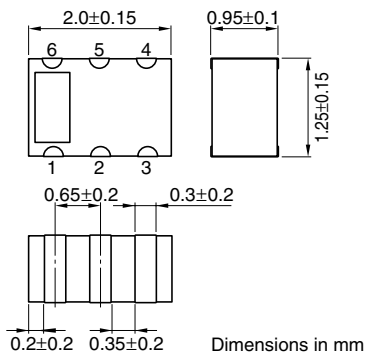

### TERMINAL FUNCTIONS

1	GND
2	ANT
3	GND
4	HIGH
5	GND
6	LOW

### RECOMMENDED PCB PATTERN

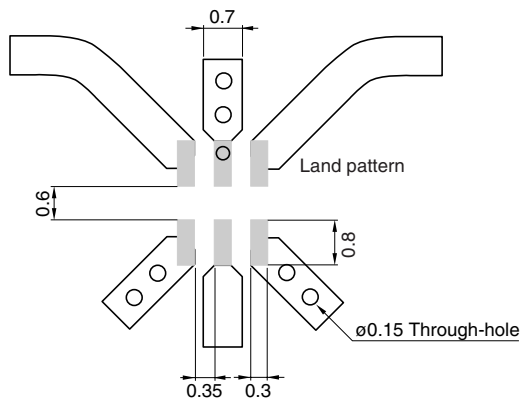

Line width be designed to match 50Ω characteristic impedance depending on PCB material and thickness.

Dimensions in mm

### ELECTRICAL CHARACTERISTICS

Item	Port	Frequency range	Minimum value	Typical value	Maximum value
Insertion loss	Lo-band	823 to 925MHz (dB)	—	—	0.55
	Lo-band	[−40 to +85°C] 823 to 925MHz (dB)	—	—	0.65
	Hi-band	1572.5 to 1578.5MHz (dB)	—	—	0.60
	Hi-band	[−40 to +85°C] 1572.5 to 1578.5MHz (dB)	—	—	0.70
VSWR	ANT	823 to 925MHz	—	—	1.60
	ANT	1572.5 to 1578.5MHz	—	—	1.60
	Lo-band	823 to 925MHz	—	—	1.60
Attenuation	Hi-band	823 to 925MHz (dB)	25.0	—	—
	Lo-band	1572.5 to 1578.5MHz (dB)	23.0	—	—
Temperature range	Operating	(°C)	−40	—	+85°C
	Storage	(°C)	−40	—	+85°C

• Ta: +25°C

### FREQUENCY CHARACTERISTICS

#### Lo-BAND PORT S21

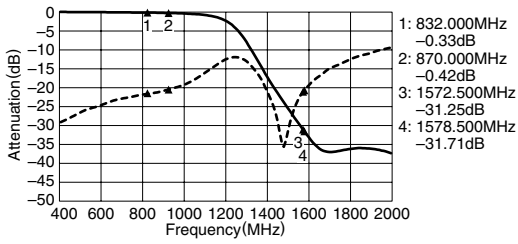

#### Hi-BAND PORT S31

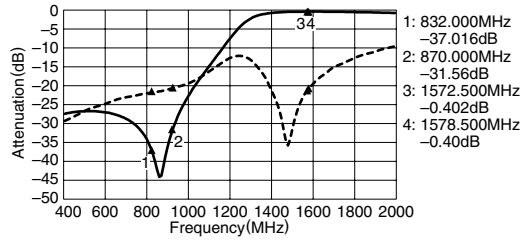

#### COMMON PORT RETURN LOSS S11

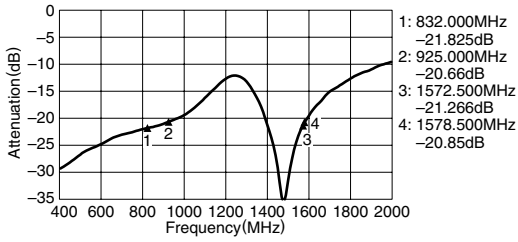

#### ISORATION S23

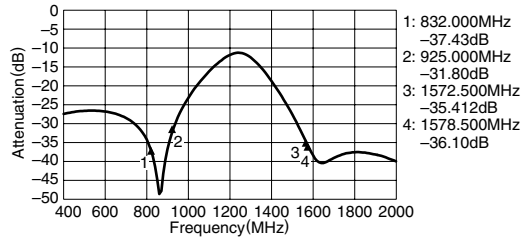

#### Lo-BAND PORT RETURN LOSS S22

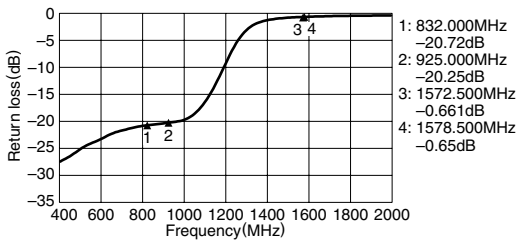

#### Hi-PORT RETURN LOSS S33

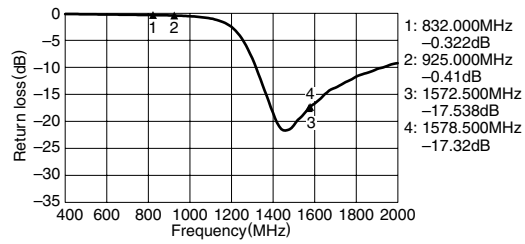

### SMITH CHART

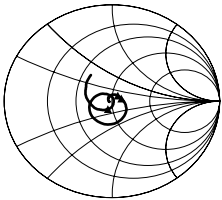

S11

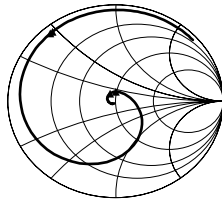

S22

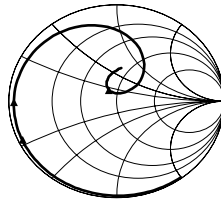

S33

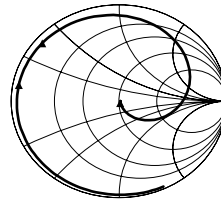

S21

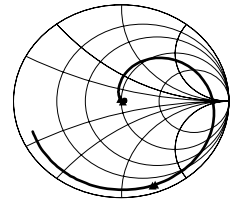

S31

# Multilayer Diplexers, DPX Series

DPX201990DT-4011D1

## SHAPES AND DIMENSIONS/CIRCUIT

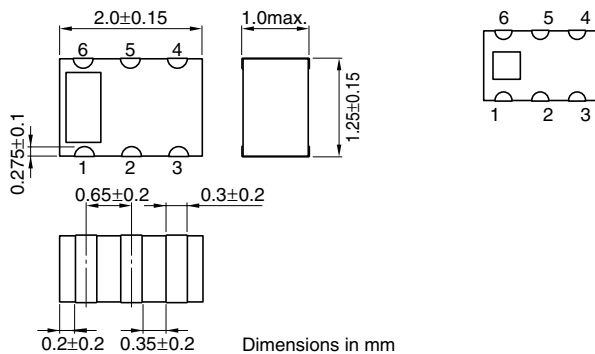

## TERMINAL FUNCTIONS

1	GND
2	ANT
3	GND
4	HIGH
5	GND
6	LOW

## RECOMMENDED PCB PATTERN

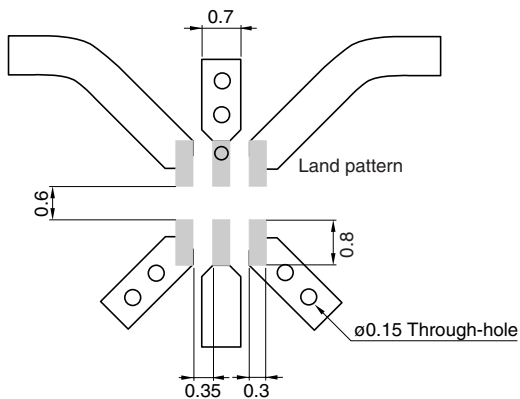

Line width be designed to match 50Ω characteristic impedance depending on PCB material and thickness.

Dimensions in mm

## ELECTRICAL CHARACTERISTICS

Item	Port	Frequency range	Minimum value	Typical value	Maximum value
Insertion loss	Lo-band	824 to 960MHz	(dB) —	—	0.5
	Hi-band	1710 to 1990MHz	(dB) —	—	0.55
Return loss	ANT	824 to 960MHz	(dB) 10.0	—	—
	ANT	1710 to 1990MHz	(dB) 10.0	—	—
Attenuation	Hi-band	824 to 960MHz	(dB) 20.0	—	—
	Lo-band	1710 to 1990MHz	(dB) 20.0	—	—
Temperature range	Operating	(°C)	−40	—	+85°C
	Storage	(°C)	−40	—	+85°C

• Ta: +25°C

### FREQUENCY CHARACTERISTICS

#### Lo-BAND PORT S21

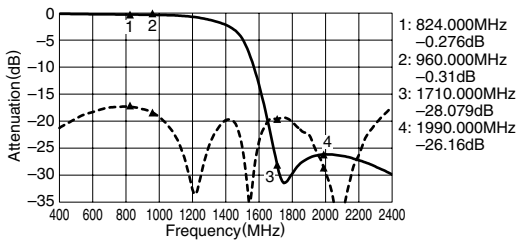

#### Hi-BAND PORT S31

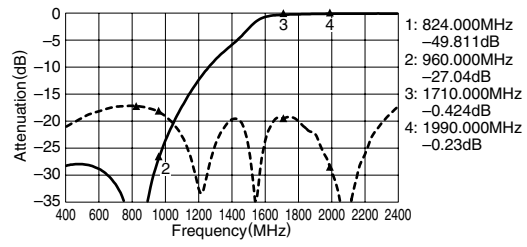

#### COMMON PORT RETURN LOSS S11

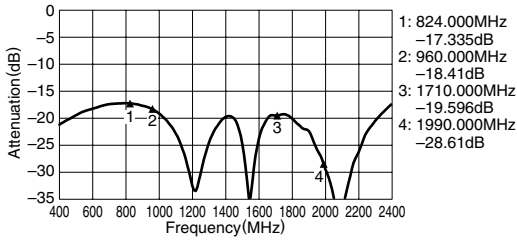

#### ISORATION S23

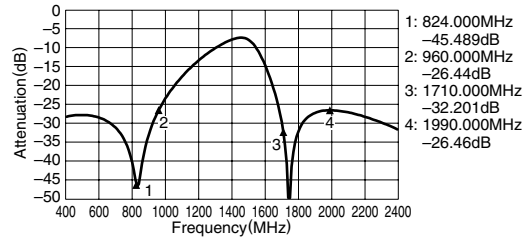

#### Lo-BAND PORT RETURN LOSS S22

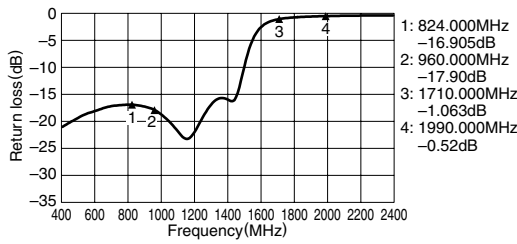

#### Hi-PORT RETURN LOSS S33

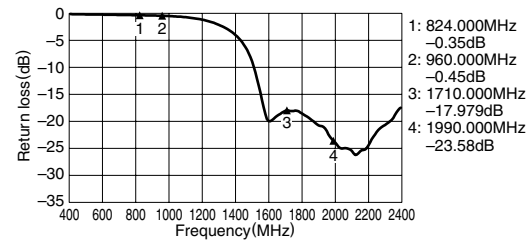

#### SMITH CHART

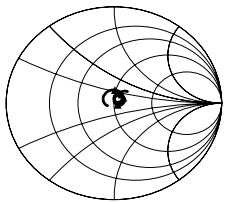

S11

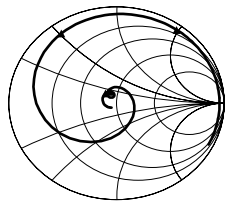

S22

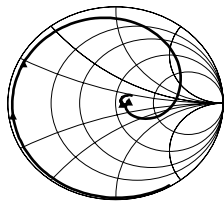

S33

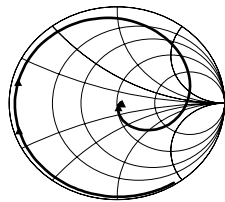

S21

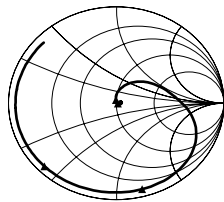

S31

# Multilayer Diplexers, DPX Series

## DPX201990DT-4012A1

### SHAPES AND DIMENSIONS/CIRCUIT

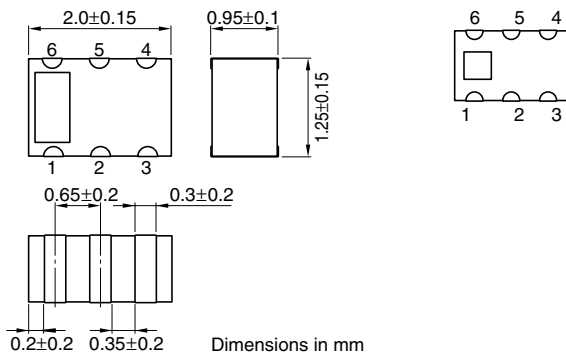

### TERMINAL FUNCTIONS

1	GND
2	ANT
3	GND
4	HIGH
5	GND
6	LOW

### RECOMMENDED PCB PATTERN

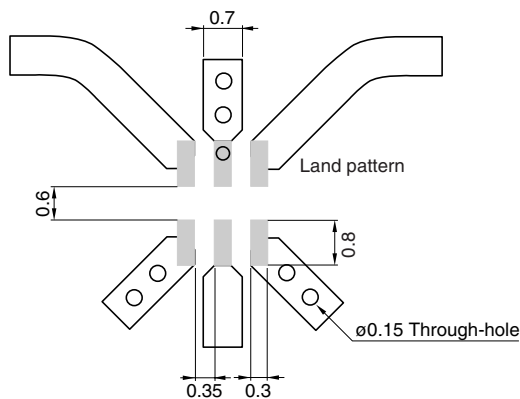

Line width be designed to match 50Ω characteristic impedance depending on PCB material and thickness.

Dimensions in mm

### ELECTRICAL CHARACTERISTICS

Item	Port	Frequency range		Minimum value	Typical value	Maximum value
Insertion loss	Lo-band	824 to 894MHz	(dB)	—	—	0.65
	Hi-band	1574 to 1576ÅA1850 to 1990MHz	(dB)	—	—	0.7
Return loss	ANT	824 to 894MHz	(dB)	10.0	—	—
	ANT	1574 to 1576ÅA1850 to 1990MHz	(dB)	10.0	—	—
Attenuation	Hi-band	824 to 894MHz	(dB)	20.0	—	—
	Lo-band	1574 to 1576ÅA1850 to 1990MHz	(dB)	20.0	—	—
Temperature range		Operating	(°C)	-40	—	+85°C
		Storage	(°C)	-40	—	+85°C

• Ta: +25°C

### FREQUENCY CHARACTERISTICS

#### Lo-BAND PORT S21

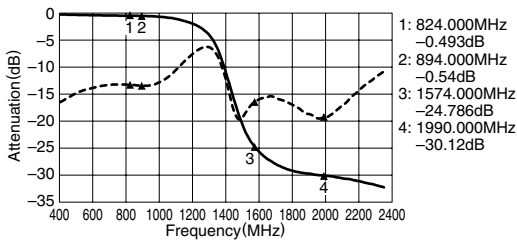

#### Hi-BAND PORT S31

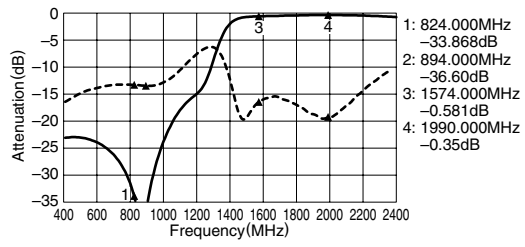

#### COMMON PORT RETURN LOSS S11

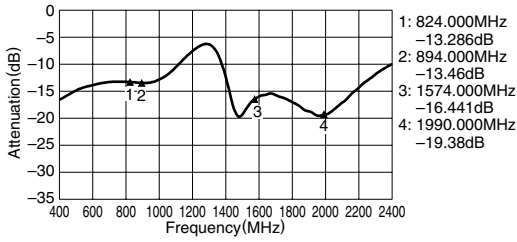

#### ISORATION S23

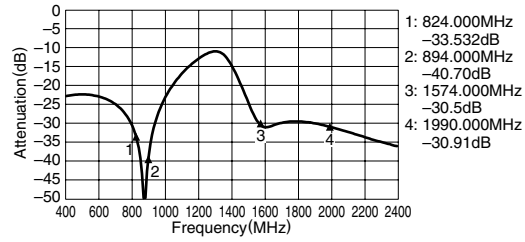

#### Lo-BAND PORT RETURN LOSS S22

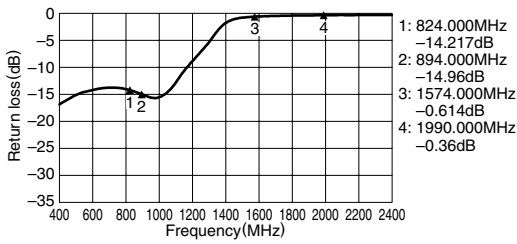

#### Hi-PORT RETURN LOSS S33

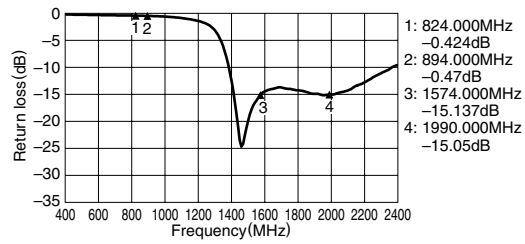

### SMITH CHART

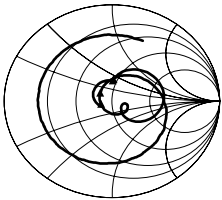

S11

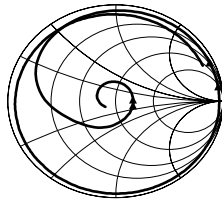

S22

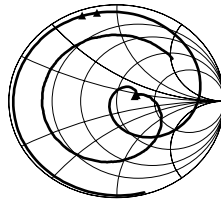

S33

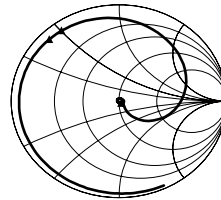

S21

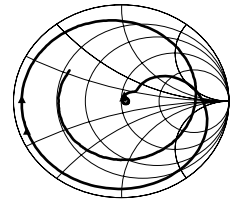

S31

# Multilayer Diplexers, DPX Series

DPX202170DT-4021A1

## SHAPES AND DIMENSIONS/CIRCUIT

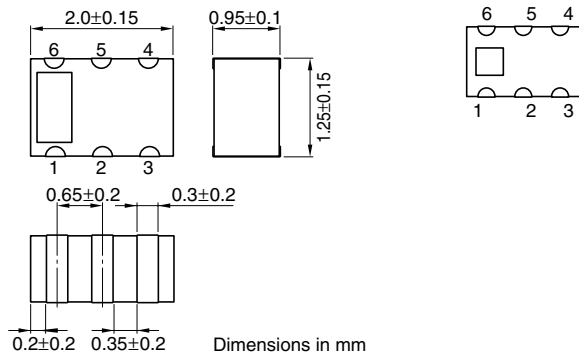

## TERMINAL FUNCTIONS

1	GND
2	ANT
3	GND
4	HIGH
5	GND
6	LOW

## RECOMMENDED PCB PATTERN

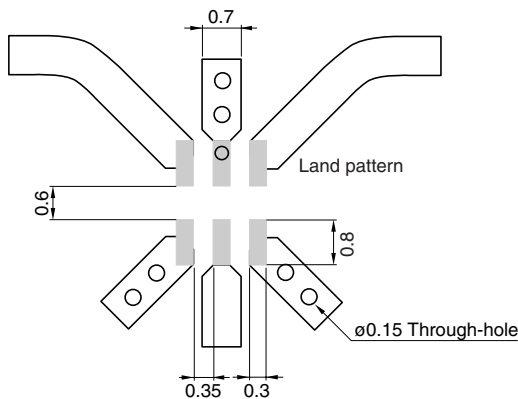

Line width be designed to match 50Ω characteristic impedance depending on PCB material and thickness.

Dimensions in mm

## ELECTRICAL CHARACTERISTICS

Item	Port	Frequency range		Minimum value	Typical value	Maximum value
Insertion loss	Lo-band	830 to 885MHz	(dB)	—	—	0.5
	Hi-band	1920 to 2170MHz	(dB)	—	—	0.5
Return loss	ANT	830 to 885MHz 1920 to 2170MHz	(dB)	10.0	—	—
Attenuation	Hi-band	830 to 885MHz	(dB)	20.0	—	—
	Lo-band	1920 to 2170MHz	(dB)	20.0	—	—
Temperature range		Operating	(°C)	−40	—	+85°C
		Storage	(°C)	−40	—	+85°C

• Ta: +25°C

### FREQUENCY CHARACTERISTICS

#### Lo-BAND PORT S21

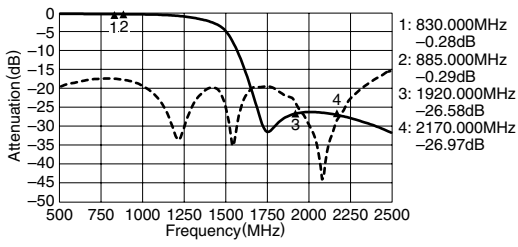

#### Hi-BAND PORT S31

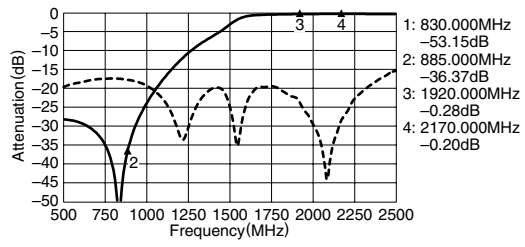

#### COMMON PORT RETURN LOSS S11

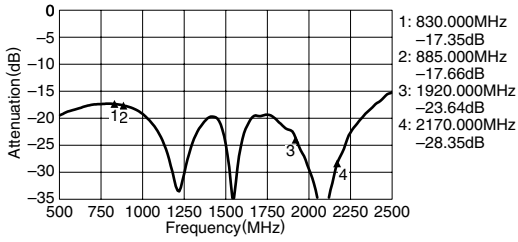

#### ISORATION S23

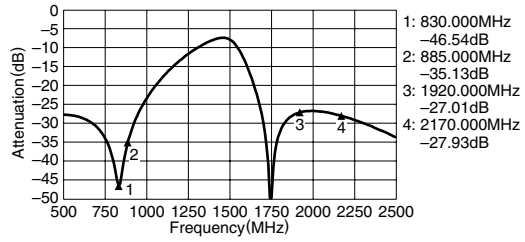

#### Lo-BAND PORT RETURN LOSS S22

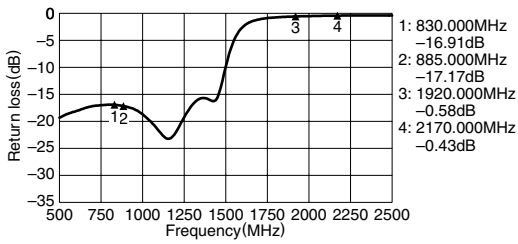

#### Hi-PORT RETURN LOSS S33

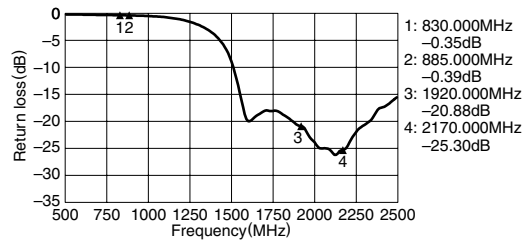

### SMITH CHART

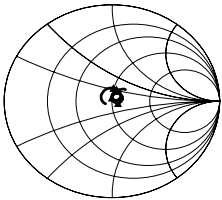

S11

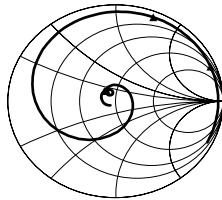

S22

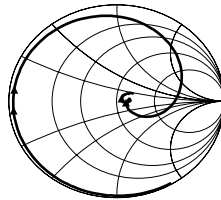

S33

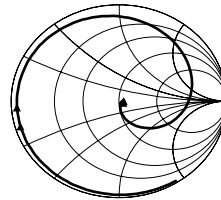

S21

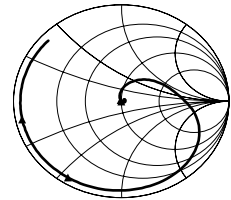

S31

# Multilayer Diplexers, DPX Series

## DPX205950DT-9008A1

### SHAPES AND DIMENSIONS/CIRCUIT

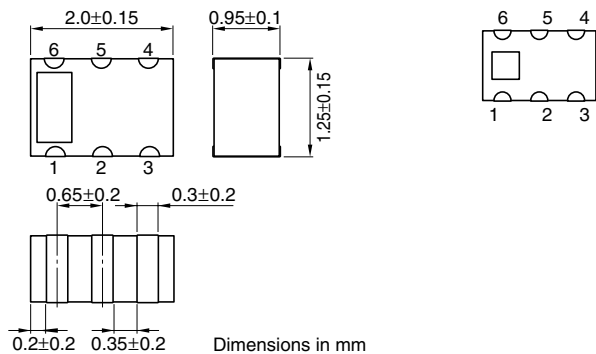

### TERMINAL FUNCTIONS

1	GND
2	ANT (COMMON)
3	GND
4	HIGH (5.0GHz)
5	GND
6	LOW (2.4GHz)

### RECOMMENDED PCB PATTERN

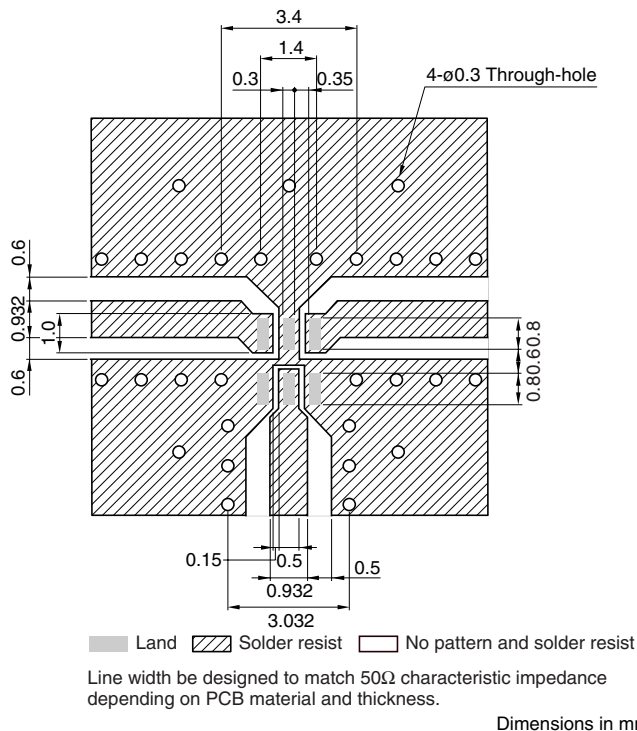

### ELECTRICAL CHARACTERISTICS

Item	Port	Frequency range	Minimum value	Typical value	Maximum value	
Insertion loss	ANT-LOW	[25±5°C]	2300 to 2500MHz (dB)	—	0.45	0.65
		[-40 to +85°C]	2300 to 2500MHz (dB)	—	—	0.8
	ANT-HIGH	[25±5°C]	4900 to 5950MHz (dB)	—	0.90	1.4
		[-40 to +85°C]	4900 to 5950MHz (dB)	—	—	1.6
Attenuation	ANT-LOW	4600 to 5000MHz (dB)	20	23	—	
		6900 to 7500MHz (dB)	20	26	—	
	ANT-HIGH	2300 to 2500MHz (dB)	20	24	—	
Return loss	ANT	9800 to 11900MHz (dB)	13	20	—	
		2300 to 2500MHz (dB)	10	20	—	
	LOW	4900 to 5950MHz (dB)	9	11	—	
		2400 to 2500MHz (dB)	10	20	—	
HIGH	4900 to 5950MHz (dB)	9	11	—		
	Temperature range	Operating (°C)	-40	—	+85°C	
Storage (°C)		-40	—	+85°C		

• Ta: +25°C

• All specifications are subject to change without notice.

### FREQUENCY CHARACTERISTICS

#### ANT-LOW S11

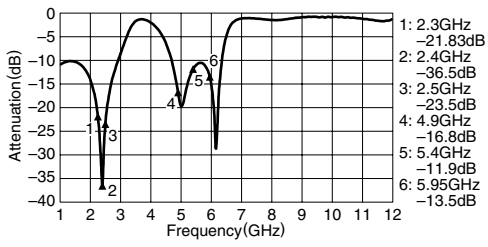

#### S21

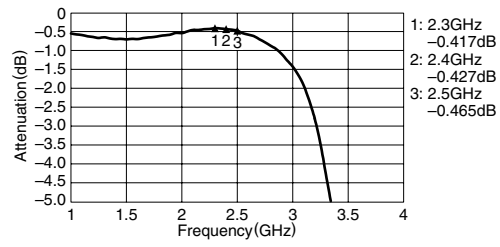

#### S21

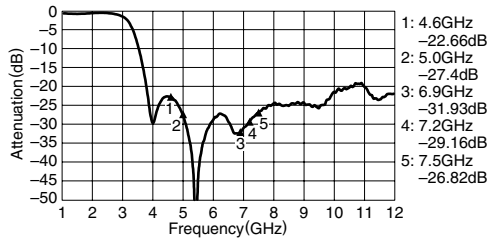

#### S22

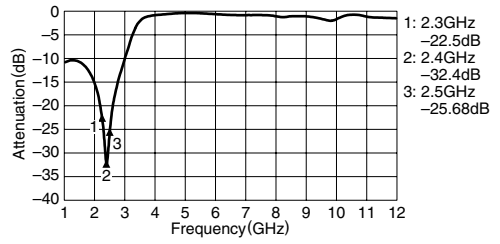

#### ANT-HIGH S11

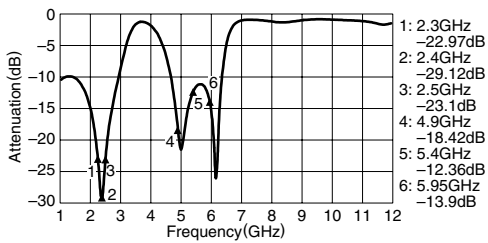

#### S21

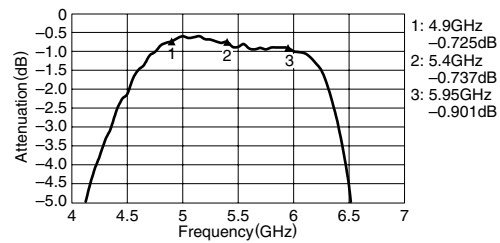

#### S21

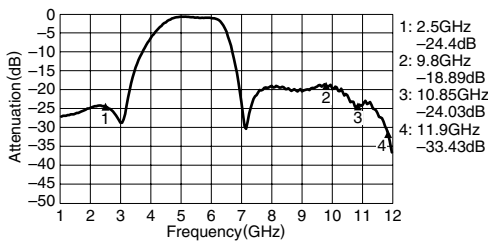

#### S22

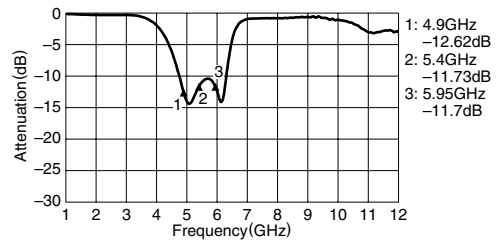

• All specifications are subject to change without notice.

# Multilayer Diplexers, DPX Series

## DPX205950DT-9108A1

### SHAPES AND DIMENSIONS/CIRCUIT

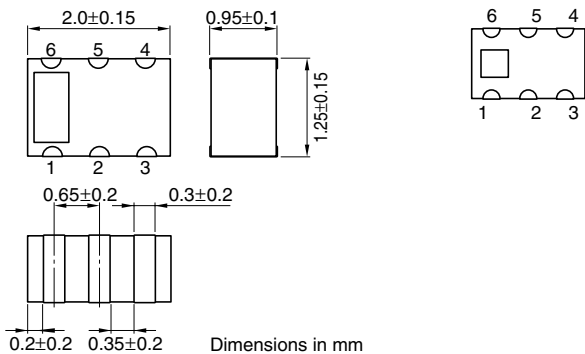

### TERMINAL FUNCTIONS

1	GND
2	ANT (COMMON)
3	GND
4	LOW (2.4GHz)
5	GND
6	HIGH (5.0GHz)

### RECOMMENDED PCB PATTERN

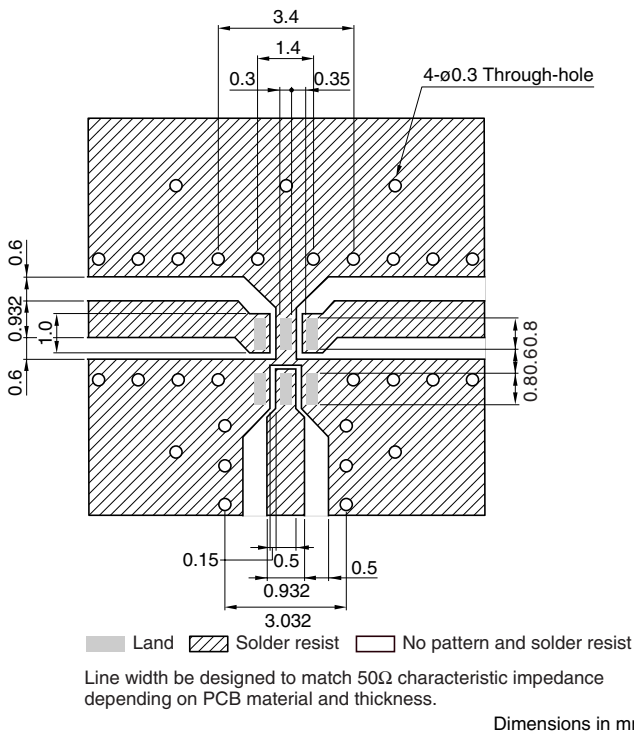

### ELECTRICAL CHARACTERISTICS

Item	Port	Frequency range	Minimum value	Typical value	Maximum value
Insertion loss	ANT-LOW	[25±5°C]	2300 to 2500MHz (dB)	—	0.45
		[-40 to +85°C]	2300 to 2500MHz (dB)	—	0.8
	ANT-HIGH	[25±5°C]	4900 to 5950MHz (dB)	—	0.90
		[-40 to +85°C]	4900 to 5950MHz (dB)	—	1.6
Attenuation	ANT-LOW	4600 to 5000MHz (dB)	20	23	—
		6900 to 7500MHz (dB)	20	26	—
	ANT-HIGH	2300 to 2500MHz (dB)	20	24	—
		9800 to 11900MHz (dB)	13	24	—
Return loss	ANT	2300 to 2500MHz (dB)	10	20	—
	ANT	4900 to 5950MHz (dB)	9	12	—
	LOW	2400 to 2500MHz (dB)	10	20	—
	HIGH	4900 to 5950MHz (dB)	9	11	—
Temperature range	Operating	(°C)	-40	—	+85°C
	Storage	(°C)	-40	—	+85°C

• Ta: +25°C

• All specifications are subject to change without notice.

### FREQUENCY CHARACTERISTICS

#### ANT-LOW S11

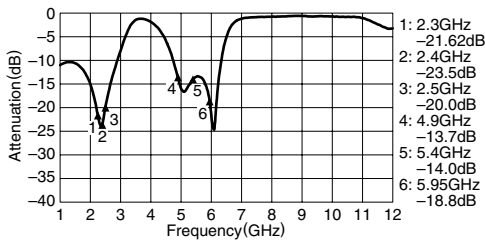

#### S21

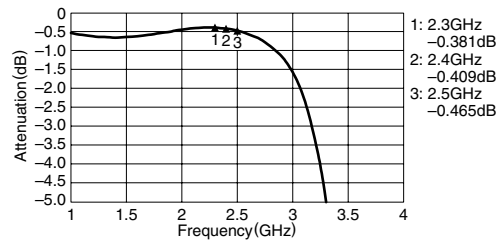

#### S21

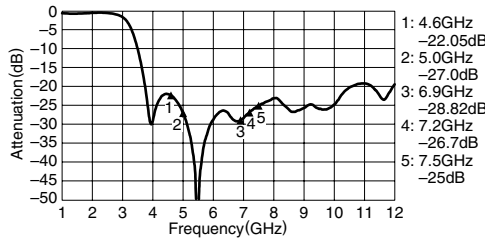

#### S22

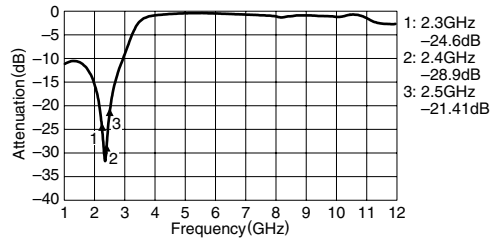

#### ANT-HIGH S11

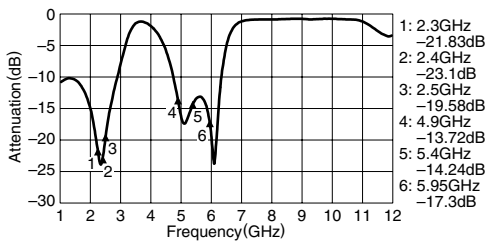

#### S21

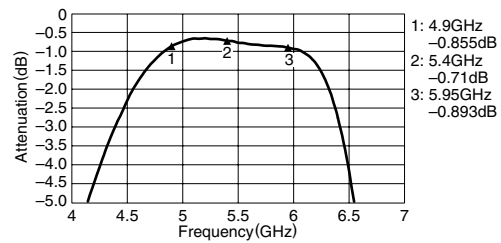

#### S21

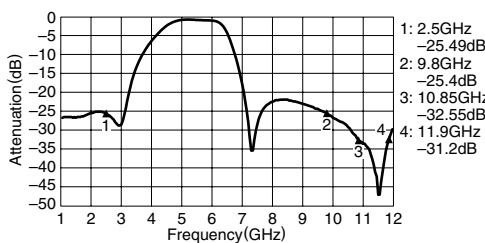

#### S22

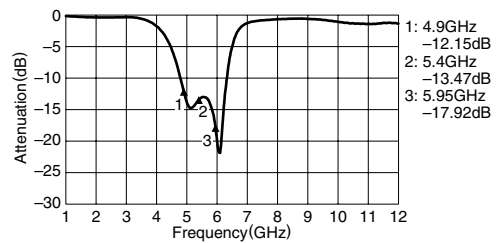

• All specifications are subject to change without notice.

# Multilayer Diplexers, DPX Series

DPX315950DT-5005B2 For 2.4/5GHz W-LAN

## SHAPES AND DIMENSIONS

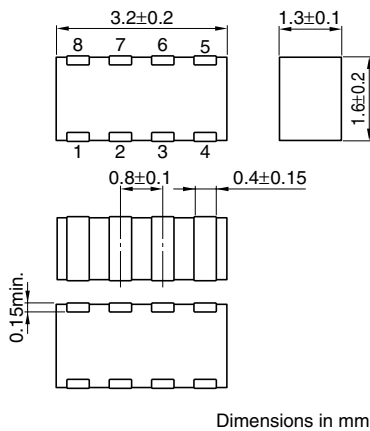

## TERMINAL FUNCTIONS

1	HIGH (5.0GHz)
2	GND
3	GND
4	LOW (2.4GHz)
5	GND
6	ANT (COMMON)
7	GND
8	GND

## RECOMMENDED PCB PATTERN

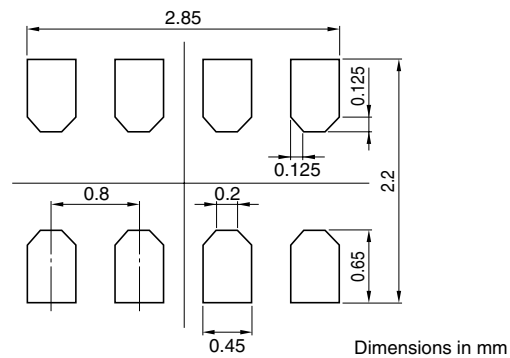

## ELECTRICAL CHARACTERISTICS

Item	Port		Frequency range		Minimum value	Typical value	Maximum value
Insertion loss	ANT-LOW	[25±5°C]	2300 to 2500MHz	(dB)	—	0.55	0.7
		[-40 to +85°C]	2300 to 2500MHz	(dB)	—	—	0.85
	ANT-HIGH	[25±5°C]	4900 to 5950MHz	(dB)	—	0.8	1.0
		[-40 to +85°C]	4900 to 5950MHz	(dB)	—	—	1.2
Attenuation	ANT-LOW		3950MHz	(dB)	18	24	—
			4600 to 5000MHz	(dB)	25	29	—
			5000 to 5950MHz	(dB)	25	29	—
			6500 to 7500MHz	(dB)	18	25	—
	ANT-HIGH		1300 to 1800MHz	(dB)	35	40	—
			1800 to 2000MHz	(dB)	37	42	—
			2100 to 2300MHz	(dB)	36	41	—
			2300 to 2500MHz	(dB)	30	38	—
			2500 to 3500MHz	(dB)	11	13.5	—
			3500 to 3950MHz	(dB)	4	7	—
Return loss	ANT		9800 to 10700MHz	(dB)	15	24	—
			10700 to 11700MHz	(dB)	10	22	—
	LOW		11700 to 11900MHz	(dB)	8	20	—
			2300 to 2500MHz	(dB)	10	15	—
HIGH		4900 to 5950MHz	(dB)	9	13	—	
		4900 to 5950MHz	(dB)	9	13	—	
Temperature range	Operating	(°C)	-40		—	—	+85
	Storage	(°C)	-40		—	—	+85

### FREQUENCY CHARACTERISTICS

#### ANT-LOW

##### S11

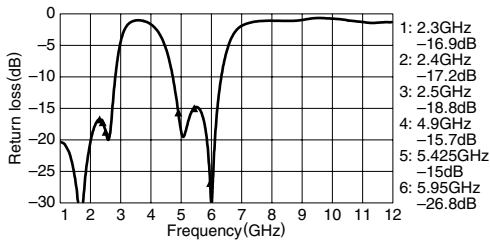

##### S21

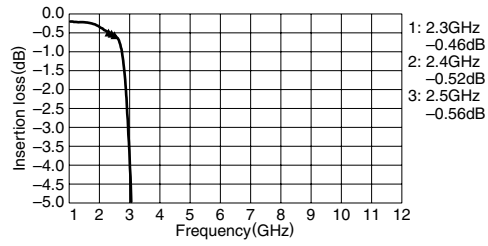

##### S21

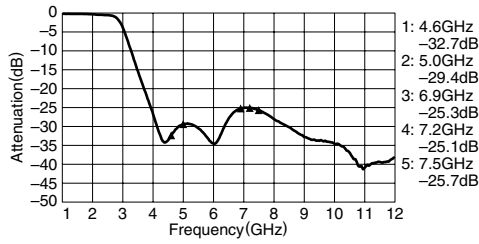

##### S22

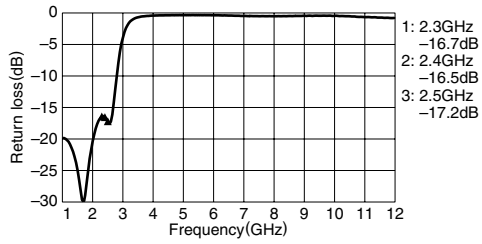

#### ANT-HIGH

##### S11

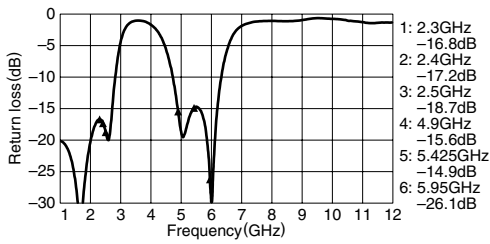

##### S21

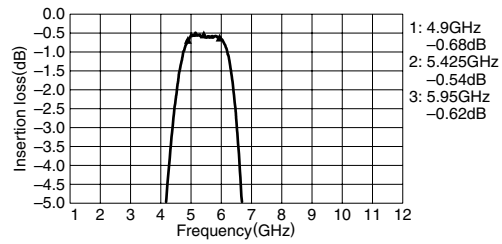

##### S21

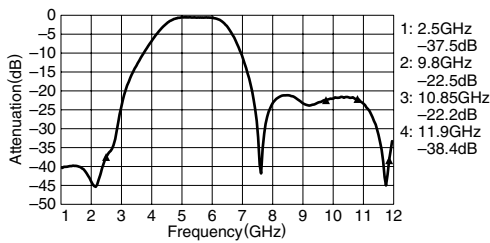

##### S22

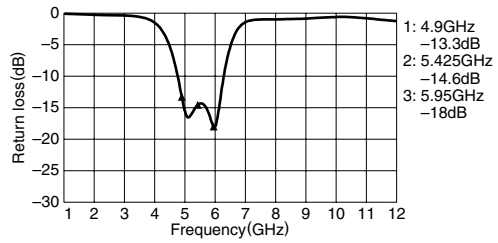

# Multilayer Diplexers, DPX Series

DPX315950DT-5006C1 For 2.4/5GHz W-LAN

## SHAPES AND DIMENSIONS

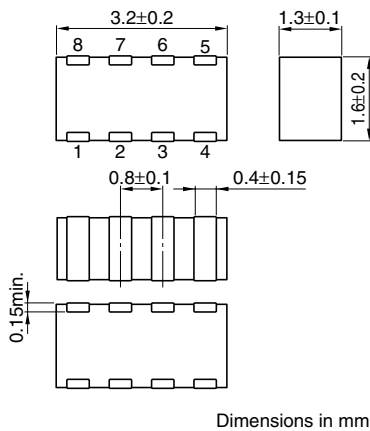

## TERMINAL FUNCTIONS

1	LOW (2.4GHz)
2	GND
3	GND
4	HIGH (5.0GHz)
5	GND
6	GND
7	ANT (COMMON)
8	GND

## RECOMMENDED PCB PATTERN

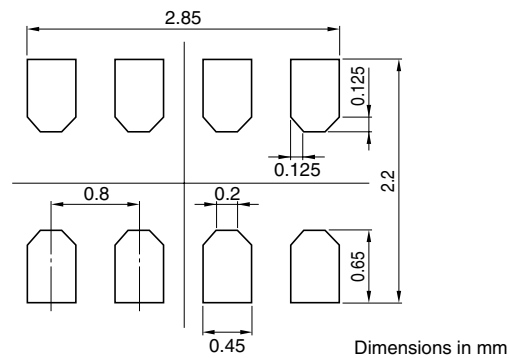

## ELECTRICAL CHARACTERISTICS

Item	Port		Frequency range	Minimum value	Typical value	Maximum value
Insertion loss	ANT-LOW	[25±5°C]	2400 to 2500MHz	(dB) —	1.0	1.5
	ANT-HIGH	[25±5°C]	5000 to 5950MHz	(dB) —	0.8	1.2
Attenuation	ANT-LOW		DC to 1500MHz	(dB) 25	30	—
			4800 to 5950MHz	(dB) 21	25	—
			6500 to 7500MHz	(dB) 10	16	—
			DC to 1500MHz	(dB) 40	48	—
	ANT-HIGH		1500 to 2000MHz	(dB) 30	48	—
			2500 to 3850MHz	(dB) 21	26	—
			3850 to 3883MHz	(dB) 19.5	25	—
			6500MHz	(dB) —	1.2	—
Return loss	ANT-HIGH		7200 to 7700MHz	(dB) 3	4.8	—
			9000 to 10000MHz	(dB) 13	16	—
			2400 to 2500MHz	(dB) 10	—	—
Temperature range		Operating	(°C) -40	—	—	+85
		Storage	(°C) -40	—	—	+85

### FREQUENCY CHARACTERISTICS

#### ANT-LOW

##### S11

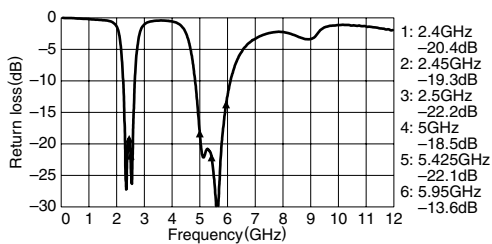

##### S21

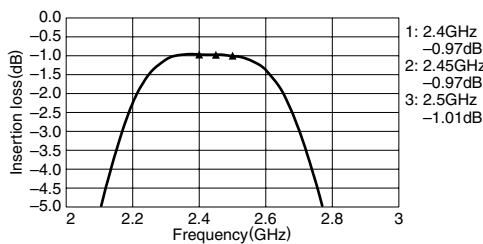

##### S21

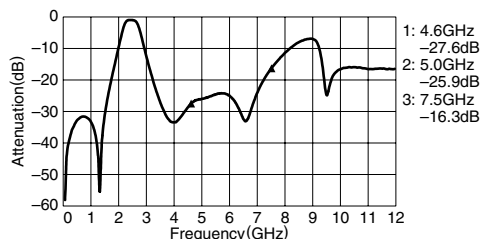

##### S22

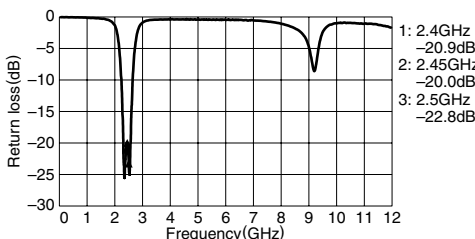

#### ANT-HIGH

##### S11

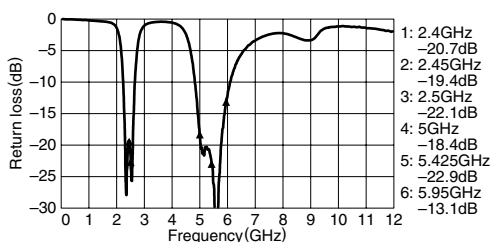

##### S21

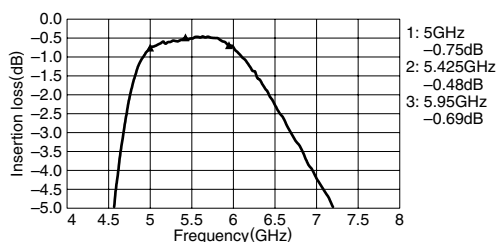

##### S21

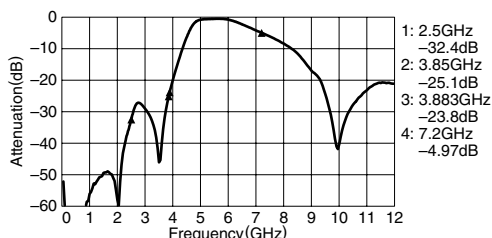

##### S22

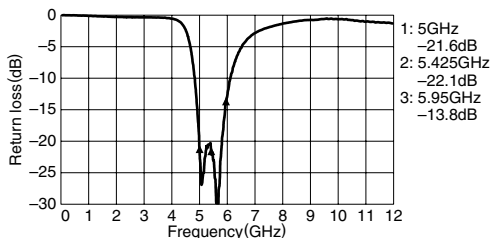

• All specifications are subject to change without notice.

## Looking for pricing, stock, or lifecycle information?

Click below to explore more details on WIN SOURCE:

 [View DPX315950DT-5006C1 on WIN SOURCE](#)

 [TDK Corporation](#) Information

## Optimize Your Supply Chain with WIN SOURCE Solutions

-  Global Sourcing Solution
-  Obsolete Management
-  Cost Control Management
-  Shortage Management
-  Alternative Solution
-  Excess Inventory Management