



**THE DATASHEET OF
ACS72981KLRATR-150B5**



High-Precision Linear Hall-Effect-Based Current Sensor IC with 200 $\mu\Omega$ Current Conductor

FEATURES AND BENEFITS

- AEC-Q100 automotive qualification
- High-bandwidth 250 kHz analog output
- Less than 2 μs output response time
- 3.3 V and 5 V supply operation
- Ultralow power loss: 200 $\mu\Omega$ internal conductor resistance
- Industry-leading noise performance and increased bandwidth through proprietary amplifier and filter design techniques
- Greatly improved total output error through digitally programmed and compensated gain and offset over the full operating temperature range
- Small package size, with easy mounting capability
- Monolithic Hall IC for high reliability
- Output voltage proportional to AC or DC currents
- Factory-trimmed for accuracy
- Extremely stable zero amp output offset voltage over temperature and lifetime

PACKAGE:

7-pin PSOF package (suffix LR)

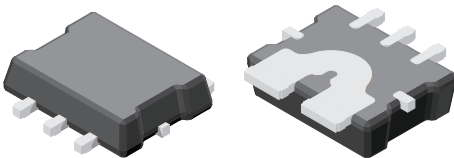

Not to scale

DESCRIPTION

The Allegro™ ACS72981 family of current sensor ICs provides economical and precise solutions for AC or DC current sensing. A 250 kHz bandwidth makes it ideal for motor control, load detection and management, power supply and DC-to-DC converter control, and inverter control. The $<2 \mu\text{s}$ response time enables overcurrent fault detection in safety-critical applications.

The device consists of a precision, low-offset linear Hall circuit with a copper conduction path located near the die. Applied current flowing through this copper conduction path generates a magnetic field which the Hall IC converts into a proportional voltage. Device accuracy is optimized through the close proximity of the magnetic signal to the Hall transducer. A precise, proportional output voltage is provided by the low-offset, chopper-stabilized BiCMOS Hall IC, which is programmed for accuracy at the factory. Proprietary digital temperature compensation technology greatly improves the zero output voltage and output sensitivity accuracy over temperature and lifetime.

The output of the device increases when an increasing current flows through the primary copper conduction path (from terminal 5 to terminal 6), which is the path used for current sampling. The internal resistance of this conductive path is 200 $\mu\Omega$ typical, providing low power loss and increasing power density in the application.

The sensor employs differential sensing techniques that virtually eliminate output disturbance due to common-mode interfering magnetic field.

Continued on the next page...

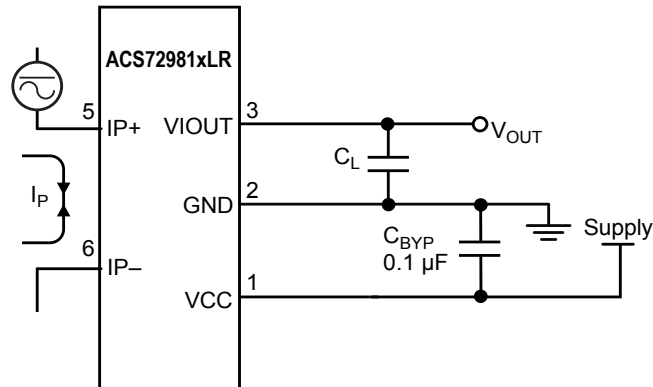

Typical Application

The ACS72981xLR outputs an analog signal, V_{OUT} , that varies linearly with the bidirectional AC or DC primary sampled current, I_P , within the range specified.

ACS72981xLR

High-Precision Linear Hall-Effect-Based Current Sensor IC with 200 $\mu\Omega$ Current Conductor

DESCRIPTION (CONTINUED)

The thickness of the copper conductor allows survival of the device at high overcurrent conditions. The terminals of the conductive path are electrically isolated from the signal leads (pins 1 through 3).

The device is fully calibrated prior to shipment from the factory. The ACS72981 family is lead (Pb) free. All leads are plated with 100% matte tin, and there is no Pb inside the package. The heavy gauge leadframe is made of oxygen-free copper.

SELECTION GUIDE

Part Number	Primary Sampled Current, I_p (A)	Sensitivity Sens (Typ.) (mV/A) ^[1]	Nominal Supply Voltage (V)	T_A (°C)	Packing ^[2]
ACS72981LLRATR-050B3	± 50	26.4	3.3	-40 to 150	3000 pieces per 13-inch reel
ACS72981LLRATR-050B5	± 50	40	5		
ACS72981LLRATR-050U3	50	52.8	3.3		
ACS72981LLRATR-050U5	50	80	5		
ACS72981LLRATR-100B3	± 100	13.2	3.3		
ACS72981LLRATR-100B5	± 100	20	5		
ACS72981LLRATR-100U3	100	26.4	3.3		
ACS72981LLRATR-100U5	100	40	5		
ACS72981KLRATR-150B3	± 150	8.8	3.3	-40 to 125	
ACS72981KLRATR-150B5	± 150	13.33	5		
ACS72981KLRATR-150U3	150	17.6	3.3		
ACS72981KLRATR-150U5	150	26.66	5		
ACS72981ELRATR-200B3	± 200	6.6	3.3	-40 to 85	
ACS72981ELRATR-200B5	± 200	10	5		
ACS72981ELRATR-200U3	200	13.2	3.3		
ACS72981ELRATR-200U5	200	20	5		

^[1] Measured at nominal supply voltage.

^[2] Contact Allegro for additional packing options.

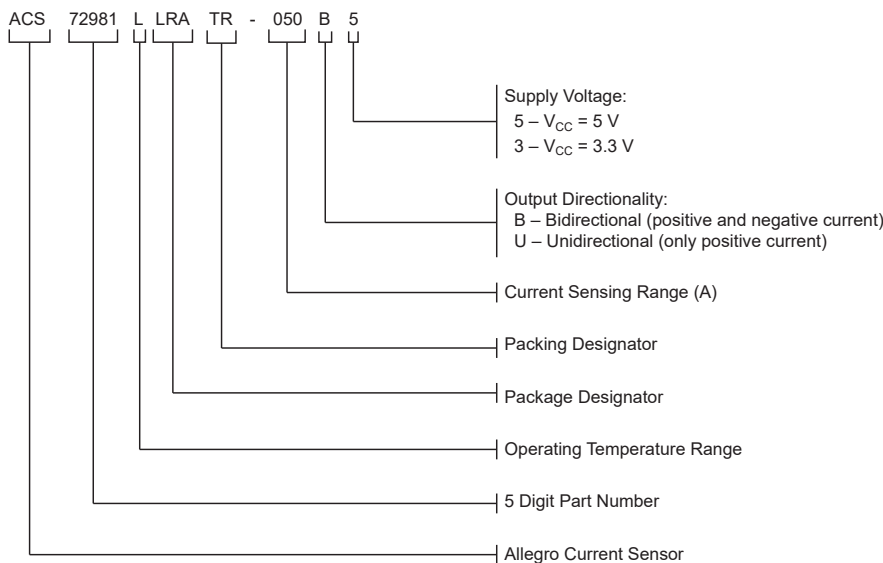

SPECIFICATIONS

ABSOLUTE MAXIMUM RATINGS

Characteristic	Symbol	Notes	Rating	Unit
Forward Supply Voltage	V_{CC}		6.5	V
Reverse Supply Voltage	V_{RCC}		-0.5	V
Output Voltage	V_{IOUT}		6.5	V
Reverse Output Voltage	V_{RIOUT}		-0.5	V
Output Current	I_{OUT}	Maximum survivable sink or source current through the output	10	mA
Working Voltage	$V_{WORKING}$	Voltage applied between pins 5-6 and all other pins	± 100	V
Maximum Continuous Current	I_{CMAX}	$T_A = 25^\circ\text{C}$	120	A
Nominal Operating Ambient Temperature	T_A	Range E	-40 to 85	$^\circ\text{C}$
		Range K	-40 to 125	$^\circ\text{C}$
		Range L	-40 to 150	$^\circ\text{C}$
Maximum Junction Temperature	$T_J(\text{max})$		165	$^\circ\text{C}$
Storage Temperature	T_{stg}		-65 to 165	$^\circ\text{C}$

ESD RATINGS

Characteristic	Symbol	Test Conditions	Value	Unit
Human Body Model	V_{HBM}	Per AEC-Q100	± 12	kV
Charged Device Model	V_{CDM}	Per AEC-Q100	± 1	kV

TYPICAL OVERCURRENT CAPABILITIES [1][2]

Characteristic	Symbol	Notes	Rating	Unit
Overcurrent	I_{POC}	$T_A = 25^\circ\text{C}$, 1 second on time, 60 seconds off time	285	A
		$T_A = 85^\circ\text{C}$, 1 second on time, 35 seconds off time	225	A
		$T_A = 125^\circ\text{C}$, 1 second on time, 30 seconds off time	170	A
		$T_A = 150^\circ\text{C}$, 1 second on time, 10 seconds off time	95	A

[1] Test was done with Allegro evaluation board. The maximum allowed current is limited by $T_J(\text{max})$ only.

[2] For more overcurrent profiles, see application note "Secrets of Measuring Currents Above 50 Amps", <https://www.allegromicro.com/en/Design-Center/Technical-Documents/Hall-Effect-Sensor-IC-Publications/AN296141-Secrets-of-Measuring-Currents-Above-50-Amps.aspx>, on the Allegro website, www.allegromicro.com.

THERMAL CHARACTERISTICS: May require derating at maximum conditions

Characteristic	Symbol	Test Conditions [1]	Value	Unit
Package Thermal Resistance	$R_{\theta JA}$	Mounted on the Allegro evaluation board ASEK72981 with FR4 substrate and 8 layers of 2 oz. copper (with an area of 1530 mm ² per layer) connected to the primary leadframe and with thermal vias connecting the copper layers. Performance is based on current flowing through the primary leadframe and includes the power consumed by the PCB.	18	$^\circ\text{C/W}$

[1] Additional thermal information available on the Allegro website

Functional Block Diagram

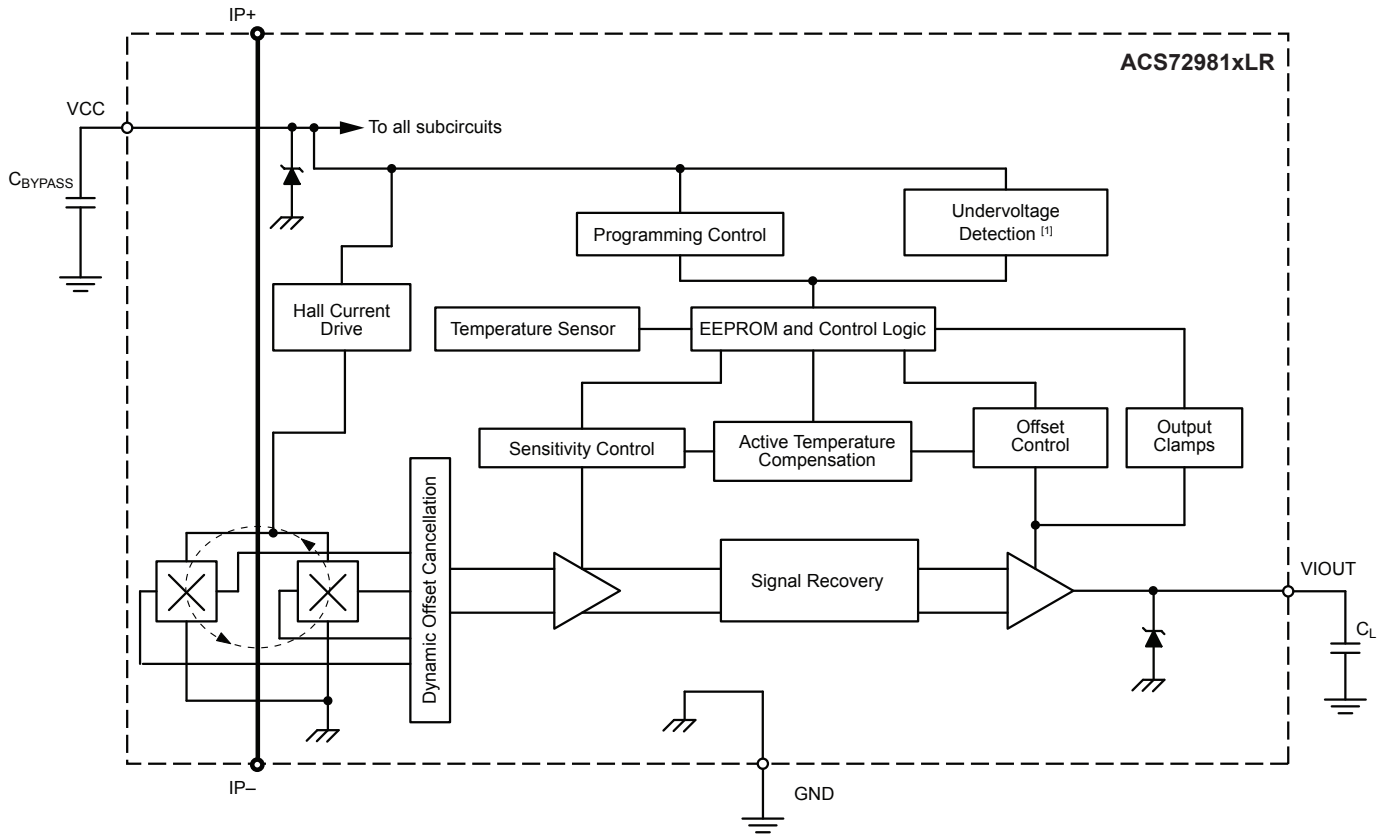

^[1] Undervoltage Detection is disabled when the supply voltage is configured to 3.3 V.

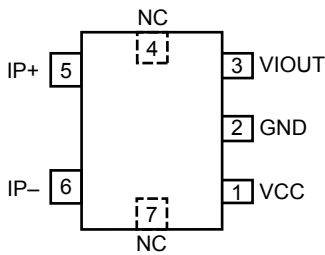

Pinout Diagram

Terminal List Table

Number	Name	Description
1	VCC	Device power supply terminal
2	GND	Device ground terminal
3	VIOUT	Analog output signal
4	NC	No connection; connect to GND for optimal ESD performance
5	IP+	Positive terminal for current being sampled
6	IP-	Negative terminal for current being sampled
7	NC	No connection; connect to GND for optimal ESD performance

COMMON OPERATING CHARACTERISTICS [1]: Valid through full range of T_A and at nominal supply voltage, unless otherwise specified

Characteristic	Symbol	Test Conditions	Min.	Typ. [2]	Max.	Unit
ELECTRICAL CHARACTERISTICS						
Supply Voltage	V_{CC}	5 V nominal supply voltage variant	4.5	5	5.5	V
		3.3 V nominal supply voltage variant	3	3.3	3.6	V
Supply Current	I_{CC}	$V_{CC}(\min) \leq V_{CC} \leq V_{CC}(\max)$, no load on output	–	14	–	mA
Power-On Delay [3]	t_{PO}	$T_A = 25^\circ\text{C}$	–	70	–	μs
Undervoltage Lockout (UVLO) Threshold [4]	V_{UVLOD}	V_{CC} rising; UVLO is disabled, enabling the device output	–	3.8	4.2	V
	V_{UVLOE}	V_{CC} falling; UVLO is enabled, disabling the device output	–	3.7	–	V
UVLO Enable/Disable Delay Time	t_{UVLOE}	Time measured from falling $V_{CC} < V_{UVLOE}$ to UVLO enabled	–	74	–	μs
	t_{UVLOD}	Time measured from rising $V_{CC} > V_{UVLOD}$ to UVLO disabled	–	7	–	μs
Power-On Reset Voltage	V_{PORH}	V_{CC} rising	–	2.8	–	V
	V_{PORL}	V_{CC} falling	–	2.5	–	V
Power-On Reset Hysteresis	$V_{HYS(POR)}$		–	250	–	mV
Internal Bandwidth	BW_i	Small signal –3 dB, $C_L = 1$ nF	–	250	–	kHz
Rise Time [3]	t_r	$T_A = 25^\circ\text{C}$, $C_L = 1$ nF, 1 V step on output	–	1.5	–	μs
Propagation Delay Time [3]	t_{pd}	$T_A = 25^\circ\text{C}$, $C_L = 1$ nF, 1 V step on output	–	1	–	μs
Response Time [3]	$t_{RESPONSE}$	$T_A = 25^\circ\text{C}$, $C_L = 1$ nF, 1 V step on output	–	1.8	–	μs
Output Slew Rate	SR	$T_A = 25^\circ\text{C}$, $C_L = 1$ nF, 1 V step on output	–	0.53	–	V/ μs
DC Output Impedance	R_{OUT}		–	< 1	–	Ω
Output Load Resistance	$R_{LOAD(MIN)}$	VIOOUT to GND	4.7	–	–	k Ω
Output Load Capacitance	$C_{LOAD(MAX)}$	VIOOUT to GND	–	1	10	nF
Primary Conductor Resistance	$R_{PRIMARY}$	$T_A = 25^\circ\text{C}$	–	200	–	$\mu\Omega$
Output Voltage Clamp	$V_{CLP(HIGH)}$	$T_A = 25^\circ\text{C}$, $R_L(\text{PULLDOWN}) = 10$ k Ω to GND	$0.9 \times V_{CC}$	–	–	V
	$V_{CLP(LOW)}$	$T_A = 25^\circ\text{C}$, $R_L(\text{PULLUP}) = 10$ k Ω to VCC	–	–	$0.1 \times V_{CC}$	V
Delay to Clamp	t_{CLP}	$T_A = 25^\circ\text{C}$; $C_L = 1$ nF; Step on I_P from $0.75 I_{PR}$ to $1.5 I_{PR}$	–	5	–	μs
Output Saturation Voltage	$V_{SAT(HIGH)}$	$T_A = 25^\circ\text{C}$, $R_L(\text{PULLDOWN}) = 10$ k Ω to GND	$V_{CC} - 0.2$	–	–	V
	$V_{SAT(LOW)}$	$T_A = 25^\circ\text{C}$, $R_L(\text{PULLUP}) = 10$ k Ω to VCC	–	–	200	mV
ERROR COMPONENTS						
QVO Ratiometry Error [5]	$V_{RatERRQVO}$	$V_{CC} = \pm 5\%$ variation of nominal supply voltage	–	± 3.5	–	mV
Sens Ratiometry Error [5]	$Rat_{ERRSens}$	$V_{CC} = \pm 5\%$ variation of nominal supply voltage	–	± 0.6	–	%
Clamp Ratiometry Error [5]	Rat_{ERRCLP}	$V_{CC} = \pm 5\%$ variation of nominal supply voltage	–	± 1.0	–	%
Noise [5]	V_N	$T_A = 25^\circ\text{C}$, $C_L = 1$ nF	–	0.4	–	$\text{mA}_{RMS}/\sqrt{\text{Hz}}$
Nonlinearity [5]	E_{LIN}	Up to full-scale I_P ; I_P applied for 5 ms	–0.8	± 0.45	0.8	%
Symmetry [5]	E_{SYM}	Over half-scale I_P	–	± 0.25	–	%
Common Mode Field Offset Error Ratio	$CMFR_{OFF}$	Measured at 100 G	–	2	–	mA/G

[1] Device may be operated at higher primary current levels, I_P , ambient, T_A , and internal leadframe temperatures, T_A , provided that the Maximum Junction Temperature, $T_J(\max)$, is not exceeded.

[2] All typical values are ± 3 sigma.

[3] See Definitions of Dynamic Response Characteristics section of this datasheet.

[4] UVLO feature is only available on part numbers programmed with a 5 V nominal supply voltage.

[5] See Definitions of Accuracy Characteristics section of this datasheet.

X050B3 PERFORMANCE CHARACTERISTICS: $T_A = -40^\circ\text{C}$ to 150°C , $V_{CC} = 3.3\text{ V}$, unless otherwise specified

Characteristic	Symbol	Test Conditions	Min.	Typ. [1]	Max.	Unit
NOMINAL PERFORMANCE						
Current Sensing Range	I_{PR}		-50	-	50	A
Sensitivity [2]	Sens	$V_{CC(\text{min})} \leq V_{CC} \leq V_{CC(\text{max})}$, $I_{PR(\text{min})} < I_P < I_{PR(\text{max})}$	-	$26.4 \times V_{CC} / 3.3$	-	mV/A
Zero-Current Output Voltage	$V_{IOUT(Q)}$	Bidirectional, $I_P = 0\text{ A}$	-	$V_{CC}/2$	-	V
ACCURACY PERFORMANCE						
Noise [2]	V_N	$T_A = 25^\circ\text{C}$, $C_L = 1\text{ nF}$, $BW = 250\text{ kHz}$	-	42	-	mV _{p-p}
		$T_A = 25^\circ\text{C}$, $C_L = 1\text{ nF}$, $BW = 250\text{ kHz}$	-	7	-	mV _{RMS}
Sensitivity Error [2]	E_{Sens}	$I_P = 37.5\text{ A}$ applied for 5 ms, $T_A = 25^\circ\text{C}$	-3.25	± 2.25	3.25	%
		$I_P = 37.5\text{ A}$ applied for 5 ms, $T_{OP} = 25^\circ\text{C}$ to 150°C	-3.25	± 2.25	3.25	%
		$I_P = 37.5\text{ A}$ applied for 5 ms, $T_{OP} = -40^\circ\text{C}$ to 25°C	-3.75	± 3.5	3.75	%
Electrical Offset Error [2]	V_{OE}	$I_P = 0\text{ A}$, $T_A = 25^\circ\text{C}$	-5	± 3.3	5	mV
		$I_P = 0\text{ A}$, $T_{OP} = 25^\circ\text{C}$ to 150°C	-5	± 3.3	5	mV
		$I_P = 0\text{ A}$, $T_{OP} = -40^\circ\text{C}$ to 25°C	-10	± 8	10	mV
Total Output Error [2]	E_{TOT}	$I_P = 37.5\text{ A}$, I_P applied for 5 ms, $T_{OP} = 25^\circ\text{C}$ to 150°C	-3.25	± 2.25	3.25	%
		$I_P = 37.5\text{ A}$, I_P applied for 5 ms, $T_{OP} = -40^\circ\text{C}$ to 25°C	-3.75	± 3.5	3.75	%
LIFETIME ACCURACY CHARACTERISTICS [3][4]						
Sensitivity Error Including Lifetime	$E_{\text{Sens(LIFE)(HT)}}$	$T_{OP} = 25^\circ\text{C}$ to 150°C	-3.7	± 2.7	3.7	%
	$E_{\text{Sens(LIFE)(LT)}}$	$T_{OP} = -40^\circ\text{C}$ to 25°C	-4.1	± 3.7	4.1	%
Total Output Including Lifetime	$E_{TOT(LIFE)(HT)}}$	$T_{OP} = 25^\circ\text{C}$ to 150°C	-3.7	± 2.7	3.7	%
	$E_{TOT(LIFE)(LT)}}$	$T_{OP} = -40^\circ\text{C}$ to 25°C	-4.1	± 3.7	4.1	%
Electric Offset Error Including Lifetime	$E_{\text{OFF(LIFE)(HT)}}$	$T_{OP} = 25^\circ\text{C}$ to 150°C	-7.0	± 4.7	7.0	mV
	$E_{\text{OFF(LIFE)(LT)}}$	$T_{OP} = -40^\circ\text{C}$ to 25°C	-12.0	± 5.5	12.0	mV

[1] All typical values are ± 3 sigma.

[2] See Definitions of Accuracy Characteristics section of this datasheet.

[3] Lifetime Accuracy Characteristics are based off of qualification testing to AEC-Q100 Grade 0 level.

[4] Solder reflow induces stress on the device; lifetime drift limits apply after solder reflow.

X050B5 PERFORMANCE CHARACTERISTICS: $T_A = -40^\circ\text{C}$ to 150°C , $V_{CC} = 5\text{ V}$, unless otherwise specified

Characteristic	Symbol	Test Conditions	Min.	Typ. [1]	Max.	Unit
NOMINAL PERFORMANCE						
Current Sensing Range	I_{PR}		-50	-	50	A
Sensitivity [2]	Sens	$V_{CC(\text{min})} \leq V_{CC} \leq V_{CC(\text{max})}$, $I_{PR(\text{min})} < I_P < I_{PR(\text{max})}$	-	$40 \times V_{CC}/5$	-	mV/A
Zero-Current Output Voltage	$V_{IOUT(Q)}$	Bidirectional, $I_P = 0\text{ A}$	-	$V_{CC}/2$	-	V
ACCURACY PERFORMANCE						
Noise [2]	V_N	$T_A = 25^\circ\text{C}$, $C_L = 1\text{ nF}$, $BW = 250\text{ kHz}$	-	60	-	mV _{p-p}
		$T_A = 25^\circ\text{C}$, $C_L = 1\text{ nF}$, $BW = 250\text{ kHz}$	-	10	-	mV _{RMS}
Sensitivity Error [2]	E_{Sens}	$I_P = 37.5\text{ A}$ applied for 5 ms, $T_A = 25^\circ\text{C}$	-3.25	± 2.25	3.25	%
		$I_P = 37.5\text{ A}$ applied for 5 ms, $T_{OP} = 25^\circ\text{C}$ to 150°C	-3.25	± 2.25	3.25	%
		$I_P = 37.5\text{ A}$ applied for 5 ms, $T_{OP} = -40^\circ\text{C}$ to 25°C	-3.75	± 3.5	3.75	%
Electrical Offset Error [2]	V_{OE}	$I_P = 0\text{ A}$, $T_A = 25^\circ\text{C}$	-5	± 3.3	5	mV
		$I_P = 0\text{ A}$, $T_{OP} = 25^\circ\text{C}$ to 150°C	-5	± 3.3	5	mV
		$I_P = 0\text{ A}$, $T_{OP} = -40^\circ\text{C}$ to 25°C	-10	± 8	10	mV
Total Output Error [2]	E_{TOT}	$I_P = 37.5\text{ A}$, I_P applied for 5 ms, $T_{OP} = 25^\circ\text{C}$ to 150°C	-3.25	± 2.25	3.25	%
		$I_P = 37.5\text{ A}$, I_P applied for 5 ms, $T_{OP} = -40^\circ\text{C}$ to 25°C	-3.75	± 3.5	3.75	%
LIFETIME ACCURACY CHARACTERISTICS [3][4]						
Sensitivity Error Including Lifetime	$E_{\text{Sens(LIFE)(HT)}}$	$T_{OP} = 25^\circ\text{C}$ to 150°C	-3.7	± 2.7	3.7	%
	$E_{\text{Sens(LIFE)(LT)}}$	$T_{OP} = -40^\circ\text{C}$ to 25°C	-4.1	± 3.7	4.1	%
Total Output Including Lifetime	$E_{TOT(LIFE)(HT)}}$	$T_{OP} = 25^\circ\text{C}$ to 150°C	-3.7	± 2.7	3.7	%
	$E_{TOT(LIFE)(LT)}}$	$T_{OP} = -40^\circ\text{C}$ to 25°C	-4.1	± 3.7	4.1	%
Electric Offset Error Including Lifetime	$E_{\text{OFF(LIFE)(HT)}}$	$T_{OP} = 25^\circ\text{C}$ to 150°C	-7.0	± 4.7	7.0	mV
	$E_{\text{OFF(LIFE)(LT)}}$	$T_{OP} = -40^\circ\text{C}$ to 25°C	-12.0	± 5.5	12.0	mV

[1] All typical values are ± 3 sigma.

[2] See Definitions of Accuracy Characteristics section of this datasheet.

[3] Lifetime Accuracy Characteristics are based off of qualification testing to AEC-Q100 Grade 0 level.

[4] Solder reflow induces stress on the device; lifetime drift limits apply after solder reflow.

X050U3 PERFORMANCE CHARACTERISTICS: $T_A = -40^\circ\text{C}$ to 150°C , $V_{CC} = 3.3\text{ V}$, unless otherwise specified

Characteristic	Symbol	Test Conditions	Min.	Typ. [1]	Max.	Unit
NOMINAL PERFORMANCE						
Current Sensing Range	I_{PR}		0	–	50	A
Sensitivity [2]	Sens	$V_{CC(\text{min})} \leq V_{CC} \leq V_{CC(\text{max})}$, $I_{PR(\text{min})} < I_P < I_{PR(\text{max})}$	–	$52.8 \times V_{CC} / 3.3$	–	mV/A
Zero-Current Output Voltage	$V_{IOUT(Q)}$	Unidirectional, $I_P = 0\text{ A}$	–	$V_{CC} / 10$	–	V
ACCURACY PERFORMANCE						
Noise [2]	V_N	$T_A = 25^\circ\text{C}$, $C_L = 1\text{ nF}$, $BW = 250\text{ kHz}$	–	78	–	mV _{p-p}
		$T_A = 25^\circ\text{C}$, $C_L = 1\text{ nF}$, $BW = 250\text{ kHz}$	–	13	–	mV _{RMS}
Sensitivity Error [2]	E_{Sens}	$I_P = 37.5\text{ A}$ applied for 5 ms, $T_A = 25^\circ\text{C}$	–3.25	± 2.25	3.25	%
		$I_P = 37.5\text{ A}$ applied for 5 ms, $T_{OP} = 25^\circ\text{C}$ to 150°C	–3.25	± 2.25	3.25	%
		$I_P = 37.5\text{ A}$ applied for 5 ms, $T_{OP} = -40^\circ\text{C}$ to 25°C	–3.75	± 3.5	3.75	%
Electrical Offset Error [2]	V_{OE}	$I_P = 0\text{ A}$, $T_A = 25^\circ\text{C}$	–5	± 3.3	5	mV
		$I_P = 0\text{ A}$, $T_{OP} = 25^\circ\text{C}$ to 150°C	–5	± 3.3	5	mV
		$I_P = 0\text{ A}$, $T_{OP} = -40^\circ\text{C}$ to 25°C	–10	± 8	10	mV
Total Output Error [2]	E_{TOT}	$I_P = 37.5\text{ A}$, I_P applied for 5 ms, $T_{OP} = 25^\circ\text{C}$ to 150°C	–3.25	± 2.25	3.25	%
		$I_P = 37.5\text{ A}$, I_P applied for 5 ms, $T_{OP} = -40^\circ\text{C}$ to 25°C	–3.75	± 3.5	3.75	%
LIFETIME ACCURACY CHARACTERISTICS [3][4]						
Sensitivity Error Including Lifetime	$E_{\text{Sens(LIFE)(HT)}}$	$T_{OP} = 25^\circ\text{C}$ to 150°C	–3.7	± 2.7	3.7	%
	$E_{\text{Sens(LIFE)(LT)}}$	$T_{OP} = -40^\circ\text{C}$ to 25°C	–4.1	± 3.7	4.1	%
Total Output Including Lifetime	$E_{TOT(LIFE)(HT)}$	$T_{OP} = 25^\circ\text{C}$ to 150°C	–3.7	± 2.7	3.7	%
	$E_{TOT(LIFE)(LT)}$	$T_{OP} = -40^\circ\text{C}$ to 25°C	–4.1	± 3.7	4.1	%
Electric Offset Error Including Lifetime	$E_{\text{OFF(LIFE)(HT)}}$	$T_{OP} = 25^\circ\text{C}$ to 150°C	–7.0	± 4.7	7.0	mV
	$E_{\text{OFF(LIFE)(LT)}}$	$T_{OP} = -40^\circ\text{C}$ to 25°C	–12.0	± 5.5	12.0	mV

[1] All typical values are ± 3 sigma.

[2] See Definitions of Accuracy Characteristics section of this datasheet.

[3] Lifetime Accuracy Characteristics are based off of qualification testing to AEC-Q100 Grade 0 level.

[4] Solder reflow induces stress on the device; lifetime drift limits apply after solder reflow.

X050U5 PERFORMANCE CHARACTERISTICS: $T_A = -40^\circ\text{C}$ to 150°C , $V_{CC} = 5\text{ V}$, unless otherwise specified

Characteristic	Symbol	Test Conditions	Min.	Typ. [1]	Max.	Unit
NOMINAL PERFORMANCE						
Current Sensing Range	I_{PR}		0	–	50	A
Sensitivity [2]	Sens	$V_{CC(\text{min})} \leq V_{CC} \leq V_{CC(\text{max})}$, $I_{PR(\text{min})} < I_P < I_{PR(\text{max})}$	–	$80 \times V_{CC} / 5$	–	mV/A
Zero-Current Output Voltage	$V_{IOUT(Q)}$	Unidirectional, $I_P = 0\text{ A}$	–	$V_{CC} / 10$	–	V
ACCURACY PERFORMANCE						
Noise [2]	V_N	$T_A = 25^\circ\text{C}$, $C_L = 1\text{ nF}$, $BW = 250\text{ kHz}$	–	120	–	mV _{p-p}
		$T_A = 25^\circ\text{C}$, $C_L = 1\text{ nF}$, $BW = 250\text{ kHz}$	–	20	–	mV _{RMS}
Sensitivity Error [2]	E_{Sens}	$I_P = 37.5\text{ A}$ applied for 5 ms, $T_A = 25^\circ\text{C}$	–3.25	± 2.25	3.25	%
		$I_P = 37.5\text{ A}$ applied for 5 ms, $T_{OP} = 25^\circ\text{C}$ to 150°C	–3.25	± 2.25	3.25	%
		$I_P = 37.5\text{ A}$ applied for 5 ms, $T_{OP} = -40^\circ\text{C}$ to 25°C	–3.75	± 3.5	3.75	%
Electrical Offset Error [2]	V_{OE}	$I_P = 0\text{ A}$, $T_A = 25^\circ\text{C}$	–5	± 3.3	5	mV
		$I_P = 0\text{ A}$, $T_{OP} = 25^\circ\text{C}$ to 150°C	–5	± 3.3	5	mV
		$I_P = 0\text{ A}$, $T_{OP} = -40^\circ\text{C}$ to 25°C	–10	± 8	10	mV
Total Output Error [2]	E_{TOT}	$I_P = 37.5\text{ A}$, I_P applied for 5 ms, $T_{OP} = 25^\circ\text{C}$ to 150°C	–3.25	± 2.25	3.25	%
		$I_P = 37.5\text{ A}$, I_P applied for 5 ms, $T_{OP} = -40^\circ\text{C}$ to 25°C	–3.75	± 3.5	3.75	%
LIFETIME ACCURACY CHARACTERISTICS [3][4]						
Sensitivity Error Including Lifetime	$E_{\text{Sens(LIFE)(HT)}}$	$T_{OP} = 25^\circ\text{C}$ to 150°C	–3.7	± 2.7	3.7	%
	$E_{\text{Sens(LIFE)(LT)}}$	$T_{OP} = -40^\circ\text{C}$ to 25°C	–4.1	± 3.7	4.1	%
Total Output Including Lifetime	$E_{TOT(LIFE)(HT)}$	$T_{OP} = 25^\circ\text{C}$ to 150°C	–3.7	± 2.7	3.7	%
	$E_{TOT(LIFE)(LT)}$	$T_{OP} = -40^\circ\text{C}$ to 25°C	–4.1	± 3.7	4.1	%
Electric Offset Error Including Lifetime	$E_{\text{OFF(LIFE)(HT)}}$	$T_{OP} = 25^\circ\text{C}$ to 150°C	–7.0	± 4.7	7.0	mV
	$E_{\text{OFF(LIFE)(LT)}}$	$T_{OP} = -40^\circ\text{C}$ to 25°C	–12.0	± 5.5	12.0	mV

[1] All typical values are ± 3 sigma.

[2] See Definitions of Accuracy Characteristics section of this datasheet.

[3] Lifetime Accuracy Characteristics are based off of qualification testing to AEC-Q100 Grade 0 level.

[4] Solder reflow induces stress on the device; lifetime drift limits apply after solder reflow.

X100B3 PERFORMANCE CHARACTERISTICS: $T_A = -40^\circ\text{C}$ to 150°C , $V_{CC} = 3.3\text{ V}$, unless otherwise specified

Characteristic	Symbol	Test Conditions	Min.	Typ. [1]	Max.	Unit
NOMINAL PERFORMANCE						
Current Sensing Range	I_{PR}		-100	-	100	A
Sensitivity [2]	Sens	$V_{CC(\min)} \leq V_{CC} \leq V_{CC(\max)}$, $I_{PR(\min)} < I_P < I_{PR(\max)}$	-	$13.2 \times V_{CC} / 3.3$	-	mV/A
Zero-Current Output Voltage	$V_{IOUT(Q)}$	Bidirectional, $I_P = 0\text{ A}$	-	$V_{CC}/2$	-	V
ACCURACY PERFORMANCE						
Noise [2]	V_N	$T_A = 25^\circ\text{C}$, $C_L = 1\text{ nF}$, $BW = 250\text{ kHz}$	-	18	-	mV _{p-p}
		$T_A = 25^\circ\text{C}$, $C_L = 1\text{ nF}$, $BW = 250\text{ kHz}$	-	3	-	mV _{RMS}
Sensitivity Error [2]	E_{Sens}	$I_P = 37.5\text{ A}$ applied for 5 ms, $T_A = 25^\circ\text{C}$	-3.25	± 2.25	3.25	%
		$I_P = 37.5\text{ A}$ applied for 5 ms, $T_{OP} = 25^\circ\text{C}$ to 150°C	-3.25	± 2.25	3.25	%
		$I_P = 37.5\text{ A}$ applied for 5 ms, $T_{OP} = -40^\circ\text{C}$ to 25°C	-3.75	± 3.5	3.75	%
Electrical Offset Error [2]	V_{OE}	$I_P = 0\text{ A}$, $T_A = 25^\circ\text{C}$	-5	± 3.3	5	mV
		$I_P = 0\text{ A}$, $T_{OP} = 25^\circ\text{C}$ to 150°C	-5	± 3.3	5	mV
		$I_P = 0\text{ A}$, $T_{OP} = -40^\circ\text{C}$ to 25°C	-10	± 8	10	mV
Total Output Error [2]	E_{TOT}	$I_P = 37.5\text{ A}$, I_P applied for 5 ms, $T_{OP} = 25^\circ\text{C}$ to 150°C	-3.25	± 2.25	3.25	%
		$I_P = 37.5\text{ A}$, I_P applied for 5 ms, $T_{OP} = -40^\circ\text{C}$ to 25°C	-3.75	± 3.5	3.75	%
LIFETIME ACCURACY CHARACTERISTICS [3][4]						
Sensitivity Error Including Lifetime	$E_{Sens(LIFE)(HT)}$	$T_{OP} = 25^\circ\text{C}$ to 150°C	-3.7	± 2.7	3.7	%
	$E_{Sens(LIFE)(LT)}$	$T_{OP} = -40^\circ\text{C}$ to 25°C	-4.1	± 3.7	4.1	%
Total Output Including Lifetime	$E_{TOT(LIFE)(HT)}$	$T_{OP} = 25^\circ\text{C}$ to 150°C	-3.7	± 2.7	3.7	%
	$E_{TOT(LIFE)(LT)}$	$T_{OP} = -40^\circ\text{C}$ to 25°C	-4.1	± 3.7	4.1	%
Electric Offset Error Including Lifetime	$E_{OFF(LIFE)(HT)}$	$T_{OP} = 25^\circ\text{C}$ to 150°C	-7.0	± 4.7	7.0	mV
	$E_{OFF(LIFE)(LT)}$	$T_{OP} = -40^\circ\text{C}$ to 25°C	-12.0	± 5.5	12.0	mV

[1] All typical values are ± 3 sigma.

[2] See Definitions of Accuracy Characteristics section of this datasheet.

[3] Lifetime Accuracy Characteristics are based off of qualification testing to AEC-Q100 Grade 0 level.

[4] Solder reflow induces stress on the device; lifetime drift limits apply after solder reflow.

X100B5 PERFORMANCE CHARACTERISTICS: $T_A = -40^\circ\text{C}$ to 150°C , $V_{CC} = 5\text{ V}$, unless otherwise specified

Characteristic	Symbol	Test Conditions	Min.	Typ. [1]	Max.	Unit
NOMINAL PERFORMANCE						
Current Sensing Range	I_{PR}		-100	-	100	A
Sensitivity [2]	Sens	$V_{CC(\min)} \leq V_{CC} \leq V_{CC(\max)}$, $I_{PR(\min)} < I_P < I_{PR(\max)}$	-	$20 \times V_{CC}/5$	-	mV/A
Zero-Current Output Voltage	$V_{IOUT(Q)}$	Bidirectional, $I_P = 0\text{ A}$	-	$V_{CC}/2$	-	V
ACCURACY PERFORMANCE						
Noise [2]	V_N	$T_A = 25^\circ\text{C}$, $C_L = 1\text{ nF}$, $BW = 250\text{ kHz}$	-	30	-	mV _{p-p}
		$T_A = 25^\circ\text{C}$, $C_L = 1\text{ nF}$, $BW = 250\text{ kHz}$	-	5	-	mV _{RMS}
Sensitivity Error [2]	E_{Sens}	$I_P = 37.5\text{ A}$ applied for 5 ms, $T_A = 25^\circ\text{C}$	-3.25	± 2.25	3.25	%
		$I_P = 37.5\text{ A}$ applied for 5 ms, $T_{OP} = 25^\circ\text{C}$ to 150°C	-3.25	± 2.25	3.25	%
		$I_P = 37.5\text{ A}$ applied for 5 ms, $T_{OP} = -40^\circ\text{C}$ to 25°C	-3.75	± 3.5	3.75	%
Electrical Offset Error [2]	V_{OE}	$I_P = 0\text{ A}$, $T_A = 25^\circ\text{C}$	-5	± 3.3	5	mV
		$I_P = 0\text{ A}$, $T_{OP} = 25^\circ\text{C}$ to 150°C	-5	± 3.3	5	mV
		$I_P = 0\text{ A}$, $T_{OP} = -40^\circ\text{C}$ to 25°C	-10	± 8	10	mV
Total Output Error [2]	E_{TOT}	$I_P = 37.5\text{ A}$, I_P applied for 5 ms, $T_{OP} = 25^\circ\text{C}$ to 150°C	-3.25	± 2.25	3.25	%
		$I_P = 37.5\text{ A}$, I_P applied for 5 ms, $T_{OP} = -40^\circ\text{C}$ to 25°C	-3.75	± 3.5	3.75	%
LIFETIME ACCURACY CHARACTERISTICS [3][4]						
Sensitivity Error Including Lifetime	$E_{Sens(LIFE)(HT)}$	$T_{OP} = 25^\circ\text{C}$ to 150°C	-3.7	± 2.7	3.7	%
	$E_{Sens(LIFE)(LT)}$	$T_{OP} = -40^\circ\text{C}$ to 25°C	-4.1	± 3.7	4.1	%
Total Output Including Lifetime	$E_{TOT(LIFE)(HT)}$	$T_{OP} = 25^\circ\text{C}$ to 150°C	-3.7	± 2.7	3.7	%
	$E_{TOT(LIFE)(LT)}$	$T_{OP} = -40^\circ\text{C}$ to 25°C	-4.1	± 3.7	4.1	%
Electric Offset Error Including Lifetime	$E_{OFF(LIFE)(HT)}$	$T_{OP} = 25^\circ\text{C}$ to 150°C	-7.0	± 4.7	7.0	mV
	$E_{OFF(LIFE)(LT)}$	$T_{OP} = -40^\circ\text{C}$ to 25°C	-12.0	± 5.5	12.0	mV

[1] All typical values are ± 3 sigma.

[2] See Definitions of Accuracy Characteristics section of this datasheet.

[3] Lifetime Accuracy Characteristics are based off of qualification testing to AEC-Q100 Grade 0 level.

[4] Solder reflow induces stress on the device; lifetime drift limits apply after solder reflow.

X100U3 PERFORMANCE CHARACTERISTICS: $T_A = -40^\circ\text{C}$ to 150°C , $V_{CC} = 3.3\text{ V}$, unless otherwise specified

Characteristic	Symbol	Test Conditions	Min.	Typ. [1]	Max.	Unit
NOMINAL PERFORMANCE						
Current Sensing Range	I_{PR}		0	–	100	A
Sensitivity [2]	Sens	$V_{CC(\min)} \leq V_{CC} \leq V_{CC(\max)}$, $I_{PR(\min)} < I_P < I_{PR(\max)}$	–	$26.4 \times V_{CC} / 3.3$	–	mV/A
Zero-Current Output Voltage	$V_{IOUT(Q)}$	Unidirectional, $I_P = 0\text{ A}$	–	$V_{CC} / 10$	–	V
ACCURACY PERFORMANCE						
Noise [2]	V_N	$T_A = 25^\circ\text{C}$, $C_L = 1\text{ nF}$, $BW = 250\text{ kHz}$	–	42	–	mV _{p-p}
		$T_A = 25^\circ\text{C}$, $C_L = 1\text{ nF}$, $BW = 250\text{ kHz}$	–	7	–	mV _{RMS}
Sensitivity Error [2]	E_{Sens}	$I_P = 37.5\text{ A}$ applied for 5 ms, $T_A = 25^\circ\text{C}$	–3.25	± 2.25	3.25	%
		$I_P = 37.5\text{ A}$ applied for 5 ms, $T_{OP} = 25^\circ\text{C}$ to 150°C	–3.25	± 2.25	3.25	%
		$I_P = 37.5\text{ A}$ applied for 5 ms, $T_{OP} = -40^\circ\text{C}$ to 25°C	–3.75	± 3.5	3.75	%
Electrical Offset Error [2]	V_{OE}	$I_P = 0\text{ A}$, $T_A = 25^\circ\text{C}$	–5	± 3.3	5	mV
		$I_P = 0\text{ A}$, $T_{OP} = 25^\circ\text{C}$ to 150°C	–5	± 3.3	5	mV
		$I_P = 0\text{ A}$, $T_{OP} = -40^\circ\text{C}$ to 25°C	–10	± 8	10	mV
Total Output Error [2]	E_{TOT}	$I_P = 37.5\text{ A}$, I_P applied for 5 ms, $T_{OP} = 25^\circ\text{C}$ to 150°C	–3.25	± 2.25	3.25	%
		$I_P = 37.5\text{ A}$, I_P applied for 5 ms, $T_{OP} = -40^\circ\text{C}$ to 25°C	–3.75	± 3.5	3.75	%
LIFETIME ACCURACY CHARACTERISTICS [3][4]						
Sensitivity Error Including Lifetime	$E_{Sens(LIFE)(HT)}$	$T_{OP} = 25^\circ\text{C}$ to 150°C	–3.7	± 2.7	3.7	%
	$E_{Sens(LIFE)(LT)}$	$T_{OP} = -40^\circ\text{C}$ to 25°C	–4.1	± 3.7	4.1	%
Total Output Including Lifetime	$E_{TOT(LIFE)(HT)}$	$T_{OP} = 25^\circ\text{C}$ to 150°C	–3.7	± 2.7	3.7	%
	$E_{TOT(LIFE)(LT)}$	$T_{OP} = -40^\circ\text{C}$ to 25°C	–4.1	± 3.7	4.1	%
Electric Offset Error Including Lifetime	$E_{OFF(LIFE)(HT)}$	$T_{OP} = 25^\circ\text{C}$ to 150°C	–7.0	± 4.7	7.0	mV
	$E_{OFF(LIFE)(LT)}$	$T_{OP} = -40^\circ\text{C}$ to 25°C	–12.0	± 5.5	12.0	mV

[1] All typical values are ± 3 sigma.

[2] See Definitions of Accuracy Characteristics section of this datasheet.

[3] Lifetime Accuracy Characteristics are based off of qualification testing to AEC-Q100 Grade 0 level.

[4] Solder reflow induces stress on the device; lifetime drift limits apply after solder reflow.

X100U5 PERFORMANCE CHARACTERISTICS: $T_A = -40^\circ\text{C}$ to 150°C , $V_{CC} = 5\text{ V}$, unless otherwise specified

Characteristic	Symbol	Test Conditions	Min.	Typ. [1]	Max.	Unit
NOMINAL PERFORMANCE						
Current Sensing Range	I_{PR}		0	–	100	A
Sensitivity [2]	Sens	$V_{CC(\text{min})} \leq V_{CC} \leq V_{CC(\text{max})}$, $I_{PR(\text{min})} < I_P < I_{PR(\text{max})}$	–	$40 \times V_{CC} / 5$	–	mV/A
Zero-Current Output Voltage	$V_{IOUT(Q)}$	Unidirectional, $I_P = 0\text{ A}$	–	$V_{CC} / 10$	–	V
ACCURACY PERFORMANCE						
Noise [2]	V_N	$T_A = 25^\circ\text{C}$, $C_L = 1\text{ nF}$, $BW = 250\text{ kHz}$	–	60	–	mV _{p-p}
		$T_A = 25^\circ\text{C}$, $C_L = 1\text{ nF}$, $BW = 250\text{ kHz}$	–	10	–	mV _{RMS}
Sensitivity Error [2]	E_{Sens}	$I_P = 37.5\text{ A}$ applied for 5 ms, $T_A = 25^\circ\text{C}$	–3.25	± 2.25	3.25	%
		$I_P = 37.5\text{ A}$ applied for 5 ms, $T_{OP} = 25^\circ\text{C}$ to 150°C	–3.25	± 2.25	3.25	%
		$I_P = 37.5\text{ A}$ applied for 5 ms, $T_{OP} = -40^\circ\text{C}$ to 25°C	–3.75	± 3.5	3.75	%
Electrical Offset Error [2]	V_{OE}	$I_P = 0\text{ A}$, $T_A = 25^\circ\text{C}$	–5	± 3.3	5	mV
		$I_P = 0\text{ A}$, $T_{OP} = 25^\circ\text{C}$ to 150°C	–5	± 3.3	5	mV
		$I_P = 0\text{ A}$, $T_{OP} = -40^\circ\text{C}$ to 25°C	–10	± 8	10	mV
Total Output Error [2]	E_{TOT}	$I_P = 37.5\text{ A}$, I_P applied for 5 ms, $T_{OP} = 25^\circ\text{C}$ to 150°C	–3.25	± 2.25	3.25	%
		$I_P = 37.5\text{ A}$, I_P applied for 5 ms, $T_{OP} = -40^\circ\text{C}$ to 25°C	–3.75	± 3.5	3.75	%
LIFETIME ACCURACY CHARACTERISTICS [3][4]						
Sensitivity Error Including Lifetime	$E_{\text{Sens(LIFE)(HT)}}$	$T_{OP} = 25^\circ\text{C}$ to 150°C	–3.7	± 2.7	3.7	%
	$E_{\text{Sens(LIFE)(LT)}}$	$T_{OP} = -40^\circ\text{C}$ to 25°C	–4.1	± 3.7	4.1	%
Total Output Including Lifetime	$E_{TOT(LIFE)(HT)}}$	$T_{OP} = 25^\circ\text{C}$ to 150°C	–3.7	± 2.7	3.7	%
	$E_{TOT(LIFE)(LT)}}$	$T_{OP} = -40^\circ\text{C}$ to 25°C	–4.1	± 3.7	4.1	%
Electric Offset Error Including Lifetime	$E_{\text{OFF(LIFE)(HT)}}$	$T_{OP} = 25^\circ\text{C}$ to 150°C	–7.0	± 4.7	7.0	mV
	$E_{\text{OFF(LIFE)(LT)}}$	$T_{OP} = -40^\circ\text{C}$ to 25°C	–12.0	± 5.5	12.0	mV

[1] All typical values are ± 3 sigma.

[2] See Definitions of Accuracy Characteristics section of this datasheet.

[3] Lifetime Accuracy Characteristics are based off of qualification testing to AEC-Q100 Grade 0 level.

[4] Solder reflow induces stress on the device; lifetime drift limits apply after solder reflow.

X150B3 PERFORMANCE CHARACTERISTICS: $T_A = -40^\circ\text{C}$ to 125°C , $V_{CC} = 3.3\text{ V}$, unless otherwise specified

Characteristic	Symbol	Test Conditions	Min.	Typ. [1]	Max.	Unit
NOMINAL PERFORMANCE						
Current Sensing Range	I_{PR}		-150	-	150	A
Sensitivity [2]	Sens	$V_{CC(\text{min})} \leq V_{CC} \leq V_{CC(\text{max})}$, $I_{PR(\text{min})} < I_P < I_{PR(\text{max})}$	-	$8.8 \times V_{CC} / 3.3$	-	mV/A
Zero-Current Output Voltage	$V_{IOUT(Q)}$	Bidirectional, $I_P = 0\text{ A}$	-	$V_{CC}/2$	-	V
ACCURACY PERFORMANCE						
Noise [2]	V_N	$T_A = 25^\circ\text{C}$, $C_L = 1\text{ nF}$, $BW = 250\text{ kHz}$	-	13.2	-	mV _{p-p}
		$T_A = 25^\circ\text{C}$, $C_L = 1\text{ nF}$, $BW = 250\text{ kHz}$	-	2.2	-	mV _{RMS}
Sensitivity Error [2]	E_{Sens}	$I_P = 37.5\text{ A}$ applied for 5 ms, $T_A = 25^\circ\text{C}$	-3.25	± 2.25	3.25	%
		$I_P = 37.5\text{ A}$ applied for 5 ms, $T_{OP} = 25^\circ\text{C}$ to 125°C	-3.25	± 2.25	3.25	%
		$I_P = 37.5\text{ A}$ applied for 5 ms, $T_{OP} = -40^\circ\text{C}$ to 25°C	-3.75	± 3.5	3.75	%
Electrical Offset Error [2]	V_{OE}	$I_P = 0\text{ A}$, $T_A = 25^\circ\text{C}$	-5	± 3.3	5	mV
		$I_P = 0\text{ A}$, $T_{OP} = 25^\circ\text{C}$ to 125°C	-5	± 3.3	5	mV
		$I_P = 0\text{ A}$, $T_{OP} = -40^\circ\text{C}$ to 25°C	-10	± 8	10	mV
Total Output Error [2]	E_{TOT}	$I_P = 37.5\text{ A}$, I_P applied for 5 ms, $T_{OP} = 25^\circ\text{C}$ to 125°C	-3.25	± 2.25	3.25	%
		$I_P = 37.5\text{ A}$, I_P applied for 5 ms, $T_{OP} = -40^\circ\text{C}$ to 25°C	-3.75	± 3.5	3.75	%
LIFETIME ACCURACY CHARACTERISTICS [3][4]						
Sensitivity Error Including Lifetime	$E_{\text{Sens(LIFE)(HT)}}$	$T_{OP} = 25^\circ\text{C}$ to 125°C	-3.7	± 2.7	3.7	%
	$E_{\text{Sens(LIFE)(LT)}}$	$T_{OP} = -40^\circ\text{C}$ to 25°C	-4.1	± 3.7	4.1	%
Total Output Including Lifetime	$E_{TOT(LIFE)(HT)}$	$T_{OP} = 25^\circ\text{C}$ to 125°C	-3.7	± 2.7	3.7	%
	$E_{TOT(LIFE)(LT)}$	$T_{OP} = -40^\circ\text{C}$ to 25°C	-4.1	± 3.7	4.1	%
Electric Offset Error Including Lifetime	$E_{\text{OFF(LIFE)(HT)}}$	$T_{OP} = 25^\circ\text{C}$ to 125°C	-7.0	± 4.7	7.0	mV
	$E_{\text{OFF(LIFE)(LT)}}$	$T_{OP} = -40^\circ\text{C}$ to 25°C	-12.0	± 5.5	12.0	mV

[1] All typical values are ± 3 sigma.

[2] See Definitions of Accuracy Characteristics section of this datasheet.

[3] Lifetime Accuracy Characteristics are based off of qualification testing to AEC-Q100 Grade 0 level.

[4] Solder reflow induces stress on the device; lifetime drift limits apply after solder reflow.

X150B5 PERFORMANCE CHARACTERISTICS: $T_A = -40^\circ\text{C}$ to 125°C , $V_{CC} = 5\text{ V}$, unless otherwise specified

Characteristic	Symbol	Test Conditions	Min.	Typ. [1]	Max.	Unit
NOMINAL PERFORMANCE						
Current Sensing Range	I_{PR}		-150	-	150	A
Sensitivity [2]	Sens	$V_{CC(\text{min})} \leq V_{CC} \leq V_{CC(\text{max})}$, $I_{PR(\text{min})} < I_P < I_{PR(\text{max})}$	-	$13.33 \times V_{CC} / 5$	-	mV/A
Zero-Current Output Voltage	$V_{IOUT(Q)}$	Bidirectional, $I_P = 0\text{ A}$	-	$V_{CC}/2$	-	V
ACCURACY PERFORMANCE						
Noise [2]	V_N	$T_A = 25^\circ\text{C}$, $C_L = 1\text{ nF}$, $BW = 250\text{ kHz}$	-	20.4	-	mV _{p-p}
		$T_A = 25^\circ\text{C}$, $C_L = 1\text{ nF}$, $BW = 250\text{ kHz}$	-	3.4	-	mV _{RMS}
Sensitivity Error [2]	E_{Sens}	$I_P = 37.5\text{ A}$ applied for 5 ms, $T_A = 25^\circ\text{C}$	-3.25	± 2.25	3.25	%
		$I_P = 37.5\text{ A}$ applied for 5 ms, $T_{OP} = 25^\circ\text{C}$ to 125°C	-3.25	± 2.25	3.25	%
		$I_P = 37.5\text{ A}$ applied for 5 ms, $T_{OP} = -40^\circ\text{C}$ to 25°C	-3.75	± 3.5	3.75	%
Electrical Offset Error [2]	V_{OE}	$I_P = 0\text{ A}$, $T_A = 25^\circ\text{C}$	-5	± 3.3	5	mV
		$I_P = 0\text{ A}$, $T_{OP} = 25^\circ\text{C}$ to 125°C	-5	± 3.3	5	mV
		$I_P = 0\text{ A}$, $T_{OP} = -40^\circ\text{C}$ to 25°C	-10	± 8	10	mV
Total Output Error [2]	E_{TOT}	$I_P = 37.5\text{ A}$, I_P applied for 5 ms, $T_{OP} = 25^\circ\text{C}$ to 125°C	-3.25	± 2.25	3.25	%
		$I_P = 37.5\text{ A}$, I_P applied for 5 ms, $T_{OP} = -40^\circ\text{C}$ to 25°C	-3.75	± 3.5	3.75	%
LIFETIME ACCURACY CHARACTERISTICS [3][4]						
Sensitivity Error Including Lifetime	$E_{\text{Sens(LIFE)(HT)}}$	$T_{OP} = 25^\circ\text{C}$ to 125°C	-3.7	± 2.7	3.7	%
	$E_{\text{Sens(LIFE)(LT)}}$	$T_{OP} = -40^\circ\text{C}$ to 25°C	-4.1	± 3.7	4.1	%
Total Output Including Lifetime	$E_{TOT(LIFE)(HT)}$	$T_{OP} = 25^\circ\text{C}$ to 125°C	-3.7	± 2.7	3.7	%
	$E_{TOT(LIFE)(LT)}$	$T_{OP} = -40^\circ\text{C}$ to 25°C	-4.1	± 3.7	4.1	%
Electric Offset Error Including Lifetime	$E_{\text{OFF(LIFE)(HT)}}$	$T_{OP} = 25^\circ\text{C}$ to 125°C	-7.0	± 4.7	7.0	mV
	$E_{\text{OFF(LIFE)(LT)}}$	$T_{OP} = -40^\circ\text{C}$ to 25°C	-12.0	± 5.5	12.0	mV

[1] All typical values are ± 3 sigma.

[2] See Definitions of Accuracy Characteristics section of this datasheet.

[3] Lifetime Accuracy Characteristics are based off of qualification testing to AEC-Q100 Grade 0 level.

[4] Solder reflow induces stress on the device; lifetime drift limits apply after solder reflow.

X150U3 PERFORMANCE CHARACTERISTICS: $T_A = -40^\circ\text{C}$ to 125°C , $V_{CC} = 3.3\text{ V}$, unless otherwise specified

Characteristic	Symbol	Test Conditions	Min.	Typ. [1]	Max.	Unit
NOMINAL PERFORMANCE						
Current Sensing Range	I_{PR}		0	–	150	A
Sensitivity [2]	Sens	$V_{CC(\text{min})} \leq V_{CC} \leq V_{CC(\text{max})}$, $I_{PR(\text{min})} < I_P < I_{PR(\text{max})}$	–	$17.6 \times V_{CC} / 3.3$	–	mV/A
Zero-Current Output Voltage	$V_{IOUT(Q)}$	Unidirectional, $I_P = 0\text{ A}$	–	$V_{CC} / 10$	–	V
ACCURACY PERFORMANCE						
Noise [2]	V_N	$T_A = 25^\circ\text{C}$, $C_L = 1\text{ nF}$, $BW = 250\text{ kHz}$	–	24	–	mV _{p-p}
		$T_A = 25^\circ\text{C}$, $C_L = 1\text{ nF}$, $BW = 250\text{ kHz}$	–	4	–	mV _{RMS}
Sensitivity Error [2]	E_{Sens}	$I_P = 37.5\text{ A}$ applied for 5 ms, $T_A = 25^\circ\text{C}$	–3.25	± 2.25	3.25	%
		$I_P = 37.5\text{ A}$ applied for 5 ms, $T_{OP} = 25^\circ\text{C}$ to 125°C	–3.25	± 2.25	3.25	%
		$I_P = 37.5\text{ A}$ applied for 5 ms, $T_{OP} = -40^\circ\text{C}$ to 25°C	–3.75	± 3.5	3.75	%
Electrical Offset Error [2]	V_{OE}	$I_P = 0\text{ A}$, $T_A = 25^\circ\text{C}$	–5	± 3.3	5	mV
		$I_P = 0\text{ A}$, $T_{OP} = 25^\circ\text{C}$ to 125°C	–5	± 3.3	5	mV
		$I_P = 0\text{ A}$, $T_{OP} = -40^\circ\text{C}$ to 25°C	–10	± 8	10	mV
Total Output Error [2]	E_{TOT}	$I_P = 37.5\text{ A}$, I_P applied for 5 ms, $T_{OP} = 25^\circ\text{C}$ to 125°C	–3.25	± 2.25	3.25	%
		$I_P = 37.5\text{ A}$, I_P applied for 5 ms, $T_{OP} = -40^\circ\text{C}$ to 25°C	–3.75	± 3.5	3.75	%
LIFETIME ACCURACY CHARACTERISTICS [3][4]						
Sensitivity Error Including Lifetime	$E_{\text{Sens(LIFE)(HT)}}$	$T_{OP} = 25^\circ\text{C}$ to 125°C	–3.7	± 2.7	3.7	%
	$E_{\text{Sens(LIFE)(LT)}}$	$T_{OP} = -40^\circ\text{C}$ to 25°C	–4.1	± 3.7	4.1	%
Total Output Including Lifetime	$E_{TOT(LIFE)(HT)}$	$T_{OP} = 25^\circ\text{C}$ to 125°C	–3.7	± 2.7	3.7	%
	$E_{TOT(LIFE)(LT)}$	$T_{OP} = -40^\circ\text{C}$ to 25°C	–4.1	± 3.7	4.1	%
Electric Offset Error Including Lifetime	$E_{\text{OFF(LIFE)(HT)}}$	$T_{OP} = 25^\circ\text{C}$ to 125°C	–7.0	± 4.7	7.0	mV
	$E_{\text{OFF(LIFE)(LT)}}$	$T_{OP} = -40^\circ\text{C}$ to 25°C	–12.0	± 5.5	12.0	mV

[1] All typical values are ± 3 sigma.

[2] See Definitions of Accuracy Characteristics section of this datasheet.

[3] Lifetime Accuracy Characteristics are based off of qualification testing to AEC-Q100 Grade 0 level.

[4] Solder reflow induces stress on the device; lifetime drift limits apply after solder reflow.

X150U5 PERFORMANCE CHARACTERISTICS: $T_A = -40^\circ\text{C}$ to 125°C , $V_{CC} = 5\text{ V}$, unless otherwise specified

Characteristic	Symbol	Test Conditions	Min.	Typ. [1]	Max.	Unit
NOMINAL PERFORMANCE						
Current Sensing Range	I_{PR}		0	–	150	A
Sensitivity [2]	Sens	$V_{CC(\text{min})} \leq V_{CC} \leq V_{CC(\text{max})}$, $I_{PR(\text{min})} < I_P < I_{PR(\text{max})}$	–	$26.66 \times V_{CC} / 5$	–	mV/A
Zero-Current Output Voltage	$V_{IOUT(Q)}$	Unidirectional, $I_P = 0\text{ A}$	–	$V_{CC} / 10$	–	V
ACCURACY PERFORMANCE						
Noise [2]	V_N	$T_A = 25^\circ\text{C}$, $C_L = 1\text{ nF}$, $BW = 250\text{ kHz}$	–	42	–	mV _{p-p}
		$T_A = 25^\circ\text{C}$, $C_L = 1\text{ nF}$, $BW = 250\text{ kHz}$	–	7	–	mV _{RMS}
Sensitivity Error [2]	E_{Sens}	$I_P = 37.5\text{ A}$ applied for 5 ms, $T_A = 25^\circ\text{C}$	–3.25	± 2.25	3.25	%
		$I_P = 37.5\text{ A}$ applied for 5 ms, $T_{OP} = 25^\circ\text{C}$ to 125°C	–3.25	± 2.25	3.25	%
		$I_P = 37.5\text{ A}$ applied for 5 ms, $T_{OP} = -40^\circ\text{C}$ to 25°C	–3.75	± 3.5	3.75	%
Electrical Offset Error [2]	V_{OE}	$I_P = 0\text{ A}$, $T_A = 25^\circ\text{C}$	–5	± 3.3	5	mV
		$I_P = 0\text{ A}$, $T_{OP} = 25^\circ\text{C}$ to 125°C	–5	± 3.3	5	mV
		$I_P = 0\text{ A}$, $T_{OP} = -40^\circ\text{C}$ to 25°C	–10	± 8	10	mV
Total Output Error [2]	E_{TOT}	$I_P = 37.5\text{ A}$, I_P applied for 5 ms, $T_{OP} = 25^\circ\text{C}$ to 125°C	–3.25	± 2.25	3.25	%
		$I_P = 37.5\text{ A}$, I_P applied for 5 ms, $T_{OP} = -40^\circ\text{C}$ to 25°C	–3.75	± 3.5	3.75	%
LIFETIME ACCURACY CHARACTERISTICS [3][4]						
Sensitivity Error Including Lifetime	$E_{\text{Sens(LIFE)(HT)}}$	$T_{OP} = 25^\circ\text{C}$ to 125°C	–3.7	± 2.7	3.7	%
	$E_{\text{Sens(LIFE)(LT)}}$	$T_{OP} = -40^\circ\text{C}$ to 25°C	–4.1	± 3.7	4.1	%
Total Output Including Lifetime	$E_{TOT(LIFE)(HT)}$	$T_{OP} = 25^\circ\text{C}$ to 125°C	–3.7	± 2.7	3.7	%
	$E_{TOT(LIFE)(LT)}$	$T_{OP} = -40^\circ\text{C}$ to 25°C	–4.1	± 3.7	4.1	%
Electric Offset Error Including Lifetime	$E_{\text{OFF(LIFE)(HT)}}$	$T_{OP} = 25^\circ\text{C}$ to 125°C	–7.0	± 4.7	7.0	mV
	$E_{\text{OFF(LIFE)(LT)}}$	$T_{OP} = -40^\circ\text{C}$ to 25°C	–12.0	± 5.5	12.0	mV

[1] All typical values are ± 3 sigma.

[2] See Definitions of Accuracy Characteristics section of this datasheet.

[3] Lifetime Accuracy Characteristics are based off of qualification testing to AEC-Q100 Grade 0 level.

[4] Solder reflow induces stress on the device; lifetime drift limits apply after solder reflow.

X200U3 PERFORMANCE CHARACTERISTICS: $T_A = -40^\circ\text{C}$ to 85°C , $V_{CC} = 3.3\text{ V}$, unless otherwise specified

Characteristic	Symbol	Test Conditions	Min.	Typ. [1]	Max.	Unit
NOMINAL PERFORMANCE						
Current Sensing Range	I_{PR}		0	–	200	A
Sensitivity [2]	Sens	$V_{CC(\text{min})} \leq V_{CC} \leq V_{CC(\text{max})}$, $I_{PR(\text{min})} < I_P < I_{PR(\text{max})}$	–	$13.2 \times V_{CC} / 3.3$	–	mV/A
Zero-Current Output Voltage	$V_{IOUT(Q)}$	Unidirectional, $I_P = 0\text{ A}$	–	$V_{CC} / 10$	–	V
ACCURACY PERFORMANCE						
Noise [2]	V_N	$T_A = 25^\circ\text{C}$, $C_L = 1\text{ nF}$, $BW = 250\text{ kHz}$	–	18	–	mV _{p-p}
		$T_A = 25^\circ\text{C}$, $C_L = 1\text{ nF}$, $BW = 250\text{ kHz}$	–	3	–	mV _{RMS}
Sensitivity Error [2]	E_{Sens}	$I_P = 37.5\text{ A}$ applied for 5 ms, $T_A = 25^\circ\text{C}$	–3.25	± 2.25	3.25	%
		$I_P = 37.5\text{ A}$ applied for 5 ms, $T_{OP} = 25^\circ\text{C}$ to 85°C	–3.25	± 2.25	3.25	%
		$I_P = 37.5\text{ A}$ applied for 5 ms, $T_{OP} = -40^\circ\text{C}$ to 25°C	–3.75	± 3.5	3.75	%
Electrical Offset Error [2]	V_{OE}	$I_P = 0\text{ A}$, $T_A = 25^\circ\text{C}$	–5	± 3.3	5	mV
		$I_P = 0\text{ A}$, $T_{OP} = 25^\circ\text{C}$ to 85°C	–5	± 3.3	5	mV
		$I_P = 0\text{ A}$, $T_{OP} = -40^\circ\text{C}$ to 25°C	–10	± 8	10	mV
Total Output Error [2]	E_{TOT}	$I_P = 37.5\text{ A}$, I_P applied for 5 ms, $T_{OP} = 25^\circ\text{C}$ to 85°C	–3.25	± 2.25	3.25	%
		$I_P = 37.5\text{ A}$, I_P applied for 5 ms, $T_{OP} = -40^\circ\text{C}$ to 25°C	–3.75	± 3.5	3.75	%
LIFETIME ACCURACY CHARACTERISTICS [3][4]						
Sensitivity Error Including Lifetime	$E_{\text{Sens(LIFE)(HT)}}$	$T_{OP} = 25^\circ\text{C}$ to 85°C	–3.7	± 2.7	3.7	%
	$E_{\text{Sens(LIFE)(LT)}}$	$T_{OP} = -40^\circ\text{C}$ to 25°C	–4.1	± 3.7	4.1	%
Total Output Including Lifetime	$E_{\text{TOT(LIFE)(HT)}}$	$T_{OP} = 25^\circ\text{C}$ to 85°C	–3.7	± 2.7	3.7	%
	$E_{\text{TOT(LIFE)(LT)}}$	$T_{OP} = -40^\circ\text{C}$ to 25°C	–4.1	± 3.7	4.1	%
Electric Offset Error Including Lifetime	$E_{\text{OFF(LIFE)(HT)}}$	$T_{OP} = 25^\circ\text{C}$ to 85°C	–7.0	± 4.7	7.0	mV
	$E_{\text{OFF(LIFE)(LT)}}$	$T_{OP} = -40^\circ\text{C}$ to 25°C	–12.0	± 5.5	12.0	mV

[1] All typical values are ± 3 sigma.

[2] See Definitions of Accuracy Characteristics section of this datasheet.

[3] Lifetime Accuracy Characteristics are based off of qualification testing to AEC-Q100 Grade 0 level.

[4] Solder reflow induces stress on the device; lifetime drift limits apply after solder reflow.

X200U5 PERFORMANCE CHARACTERISTICS: $T_A = -40^\circ\text{C}$ to 85°C , $V_{CC} = 5\text{ V}$, unless otherwise specified

Characteristic	Symbol	Test Conditions	Min.	Typ. [1]	Max.	Unit
NOMINAL PERFORMANCE						
Current Sensing Range	I_{PR}		0	–	200	A
Sensitivity [2]	Sens	$V_{CC(\text{min})} \leq V_{CC} \leq V_{CC(\text{max})}$, $I_{PR(\text{min})} < I_P < I_{PR(\text{max})}$	–	$20 \times V_{CC} / 5$	–	mV/A
Zero-Current Output Voltage	$V_{IOUT(Q)}$	Unidirectional, $I_P = 0\text{ A}$	–	$V_{CC} / 10$	–	V
ACCURACY PERFORMANCE						
Noise [2]	V_N	$T_A = 25^\circ\text{C}$, $C_L = 1\text{ nF}$, $BW = 250\text{ kHz}$	–	30	–	mV _{p-p}
		$T_A = 25^\circ\text{C}$, $C_L = 1\text{ nF}$, $BW = 250\text{ kHz}$	–	5	–	mV _{RMS}
Sensitivity Error [2]	E_{Sens}	$I_P = 37.5\text{ A}$ applied for 5 ms, $T_A = 25^\circ\text{C}$	–3.25	± 2.25	3.25	%
		$I_P = 37.5\text{ A}$ applied for 5 ms, $T_{OP} = 25^\circ\text{C}$ to 85°C	–3.25	± 2.25	3.25	%
		$I_P = 37.5\text{ A}$ applied for 5 ms, $T_{OP} = -40^\circ\text{C}$ to 25°C	–3.75	± 3.5	3.75	%
Electrical Offset Error [2]	V_{OE}	$I_P = 0\text{ A}$, $T_A = 25^\circ\text{C}$	–5	± 3.3	5	mV
		$I_P = 0\text{ A}$, $T_{OP} = 25^\circ\text{C}$ to 85°C	–5	± 3.3	5	mV
		$I_P = 0\text{ A}$, $T_{OP} = -40^\circ\text{C}$ to 25°C	–10	± 8	10	mV
Total Output Error [2]	E_{TOT}	$I_P = 37.5\text{ A}$, I_P applied for 5 ms, $T_{OP} = 25^\circ\text{C}$ to 85°C	–3.25	± 2.25	3.25	%
		$I_P = 37.5\text{ A}$, I_P applied for 5 ms, $T_{OP} = -40^\circ\text{C}$ to 25°C	–3.75	± 3.5	3.75	%
LIFETIME ACCURACY CHARACTERISTICS [3][4]						
Sensitivity Error Including Lifetime	$E_{\text{Sens(LIFE)(HT)}}$	$T_{OP} = 25^\circ\text{C}$ to 85°C	–3.7	± 2.7	3.7	%
	$E_{\text{Sens(LIFE)(LT)}}$	$T_{OP} = -40^\circ\text{C}$ to 25°C	–4.1	± 3.7	4.1	%
Total Output Including Lifetime	$E_{\text{TOT(LIFE)(HT)}}$	$T_{OP} = 25^\circ\text{C}$ to 85°C	–3.7	± 2.7	3.7	%
	$E_{\text{TOT(LIFE)(LT)}}$	$T_{OP} = -40^\circ\text{C}$ to 25°C	–4.1	± 3.7	4.1	%
Electric Offset Error Including Lifetime	$E_{\text{OFF(LIFE)(HT)}}$	$T_{OP} = 25^\circ\text{C}$ to 85°C	–7.0	± 4.7	7.0	mV
	$E_{\text{OFF(LIFE)(LT)}}$	$T_{OP} = -40^\circ\text{C}$ to 25°C	–12.0	± 5.5	12.0	mV

[1] All typical values are ± 3 sigma.

[2] See Definitions of Accuracy Characteristics section of this datasheet.

[3] Lifetime Accuracy Characteristics are based off of qualification testing to AEC-Q100 Grade 0 level.

[4] Solder reflow induces stress on the device; lifetime drift limits apply after solder reflow.

X200B3 PERFORMANCE CHARACTERISTICS: $T_A = -40^\circ\text{C}$ to 85°C , $V_{CC} = 3.3\text{ V}$, unless otherwise specified

Characteristic	Symbol	Test Conditions	Min.	Typ. [1]	Max.	Unit
NOMINAL PERFORMANCE						
Current Sensing Range	I_{PR}		-200	-	200	A
Sensitivity [2]	Sens	$V_{CC(\text{min})} \leq V_{CC} \leq V_{CC(\text{max})}$, $I_{PR(\text{min})} < I_P < I_{PR(\text{max})}$	-	$6.6 \times V_{CC} / 3.3$	-	mV/A
Zero-Current Output Voltage	$V_{IOUT(Q)}$	Bidirectional, $I_P = 0\text{ A}$	-	$V_{CC}/2$	-	V
ACCURACY PERFORMANCE						
Noise [2]	V_N	$T_A = 25^\circ\text{C}$, $C_L = 1\text{ nF}$, $BW = 250\text{ kHz}$	-	12	-	mV _{p-p}
		$T_A = 25^\circ\text{C}$, $C_L = 1\text{ nF}$, $BW = 250\text{ kHz}$	-	2	-	mV _{RMS}
Sensitivity Error [2]	E_{Sens}	$I_P = 37.5\text{ A}$ applied for 5 ms, $T_A = 25^\circ\text{C}$	-3.25	± 2.25	3.25	%
		$I_P = 37.5\text{ A}$ applied for 5 ms, $T_{OP} = 25^\circ\text{C}$ to 85°C	-3.25	± 2.25	3.25	%
		$I_P = 37.5\text{ A}$ applied for 5 ms, $T_{OP} = -40^\circ\text{C}$ to 25°C	-3.75	± 3.5	3.75	%
Electrical Offset Error [2]	V_{OE}	$I_P = 0\text{ A}$, $T_A = 25^\circ\text{C}$	-5	± 3.3	5	mV
		$I_P = 0\text{ A}$, $T_{OP} = 25^\circ\text{C}$ to 85°C	-5	± 3.3	5	mV
		$I_P = 0\text{ A}$, $T_{OP} = -40^\circ\text{C}$ to 25°C	-10	± 8	10	mV
Total Output Error [2]	E_{TOT}	$I_P = 37.5\text{ A}$, I_P applied for 5 ms, $T_{OP} = 25^\circ\text{C}$ to 85°C	-3.25	± 2.25	3.25	%
		$I_P = 37.5\text{ A}$, I_P applied for 5 ms, $T_{OP} = -40^\circ\text{C}$ to 25°C	-3.75	± 3.5	3.75	%
LIFETIME ACCURACY CHARACTERISTICS [3][4]						
Sensitivity Error Including Lifetime	$E_{\text{Sens(LIFE)(HT)}}$	$T_{OP} = 25^\circ\text{C}$ to 85°C	-3.7	± 2.7	3.7	%
	$E_{\text{Sens(LIFE)(LT)}}$	$T_{OP} = -40^\circ\text{C}$ to 25°C	-4.1	± 3.7	4.1	%
Total Output Including Lifetime	$E_{\text{TOT(LIFE)(HT)}}$	$T_{OP} = 25^\circ\text{C}$ to 85°C	-3.7	± 2.7	3.7	%
	$E_{\text{TOT(LIFE)(LT)}}$	$T_{OP} = -40^\circ\text{C}$ to 25°C	-4.1	± 3.7	4.1	%
Electric Offset Error Including Lifetime	$E_{\text{OFF(LIFE)(HT)}}$	$T_{OP} = 25^\circ\text{C}$ to 85°C	-7.0	± 4.7	7.0	mV
	$E_{\text{OFF(LIFE)(LT)}}$	$T_{OP} = -40^\circ\text{C}$ to 25°C	-12.0	± 5.5	12.0	mV

[1] All typical values are ± 3 sigma.

[2] See Definitions of Accuracy Characteristics section of this datasheet.

[3] Lifetime Accuracy Characteristics are based off of qualification testing to AEC-Q100 Grade 0 level.

[4] Solder reflow induces stress on the device; lifetime drift limits apply after solder reflow.

X200B5 PERFORMANCE CHARACTERISTICS: $T_A = -40^\circ\text{C}$ to 85°C , $V_{CC} = 5\text{ V}$, unless otherwise specified

Characteristic	Symbol	Test Conditions	Min.	Typ. [1]	Max.	Unit
NOMINAL PERFORMANCE						
Current Sensing Range	I_{PR}		-200	-	200	A
Sensitivity [2]	Sens	$V_{CC(\text{min})} \leq V_{CC} \leq V_{CC(\text{max})}$, $I_{PR(\text{min})} < I_P < I_{PR(\text{max})}$	-	$10 \times V_{CC} / 5$	-	mV/A
Zero-Current Output Voltage	$V_{IOUT(Q)}$	Bidirectional, $I_P = 0\text{ A}$	-	$V_{CC}/2$	-	V
ACCURACY PERFORMANCE						
Noise [2]	V_N	$T_A = 25^\circ\text{C}$, $C_L = 1\text{ nF}$, $BW = 250\text{ kHz}$	-	18	-	mV _{p-p}
		$T_A = 25^\circ\text{C}$, $C_L = 1\text{ nF}$, $BW = 250\text{ kHz}$	-	3	-	mV _{RMS}
Sensitivity Error [2]	E_{Sens}	$I_P = 37.5\text{ A}$ applied for 5 ms, $T_A = 25^\circ\text{C}$	-3.25	± 2.25	3.25	%
		$I_P = 37.5\text{ A}$ applied for 5 ms, $T_{OP} = 25^\circ\text{C}$ to 85°C	-3.25	± 2.25	3.25	%
		$I_P = 37.5\text{ A}$ applied for 5 ms, $T_{OP} = -40^\circ\text{C}$ to 25°C	-3.75	± 3.5	3.75	%
Electrical Offset Error [2]	V_{OE}	$I_P = 0\text{ A}$, $T_A = 25^\circ\text{C}$	-5	± 3.3	5	mV
		$I_P = 0\text{ A}$, $T_{OP} = 25^\circ\text{C}$ to 85°C	-5	± 3.3	5	mV
		$I_P = 0\text{ A}$, $T_{OP} = -40^\circ\text{C}$ to 25°C	-10	± 8	10	mV
Total Output Error [2]	E_{TOT}	$I_P = 37.5\text{ A}$, I_P applied for 5 ms, $T_{OP} = 25^\circ\text{C}$ to 85°C	-3.25	± 2.25	3.25	%
		$I_P = 37.5\text{ A}$, I_P applied for 5 ms, $T_{OP} = -40^\circ\text{C}$ to 25°C	-3.75	± 3.5	3.75	%
LIFETIME ACCURACY CHARACTERISTICS [3][4]						
Sensitivity Error Including Lifetime	$E_{\text{Sens(LIFE)(HT)}}$	$T_{OP} = 25^\circ\text{C}$ to 85°C	-3.7	± 2.7	3.7	%
	$E_{\text{Sens(LIFE)(LT)}}$	$T_{OP} = -40^\circ\text{C}$ to 25°C	-4.1	± 3.7	4.1	%
Total Output Including Lifetime	$E_{\text{TOT(LIFE)(HT)}}$	$T_{OP} = 25^\circ\text{C}$ to 85°C	-3.7	± 2.7	3.7	%
	$E_{\text{TOT(LIFE)(LT)}}$	$T_{OP} = -40^\circ\text{C}$ to 25°C	-4.1	± 3.7	4.1	%
Electric Offset Error Including Lifetime	$E_{\text{OFF(LIFE)(HT)}}$	$T_{OP} = 25^\circ\text{C}$ to 85°C	-7.0	± 4.7	7.0	mV
	$E_{\text{OFF(LIFE)(LT)}}$	$T_{OP} = -40^\circ\text{C}$ to 25°C	-12.0	± 5.5	12.0	mV

[1] All typical values are ± 3 sigma.

[2] See Definitions of Accuracy Characteristics section of this datasheet.

[3] Lifetime Accuracy Characteristics are based off of qualification testing to AEC-Q100 Grade 0 level.

[4] Solder reflow induces stress on the device; lifetime drift limits apply after solder reflow.

CHARACTERISTIC PERFORMANCE DATA

Response Time (t_{RESPONSE})

25 A excitation signal with 10%-90% rise time = 1 μs

Sensitivity = 40 mV/A, $C_{\text{BYPASS}} = 0.1 \mu\text{F}$, $C_{\text{L}} = 1 \text{ nF}$

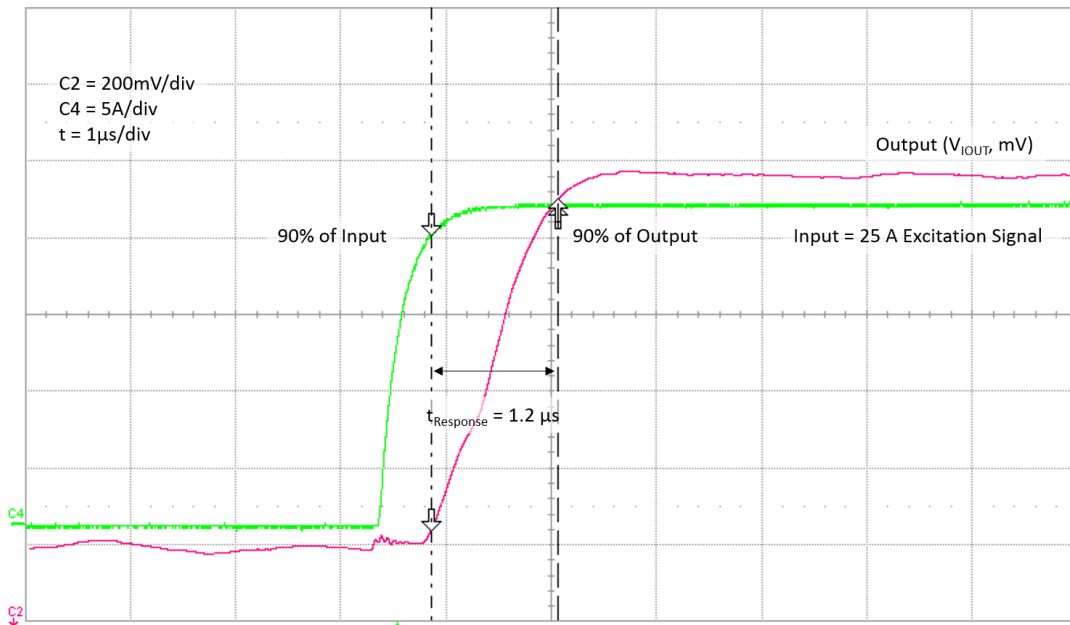

Propagation Delay (t_{pd})

25 A excitation signal with 10%-90% rise time = 1 μs

Sensitivity = 40 mV/A, $C_{\text{BYPASS}} = 0.1 \mu\text{F}$, $C_{\text{L}} = 1 \text{ nF}$

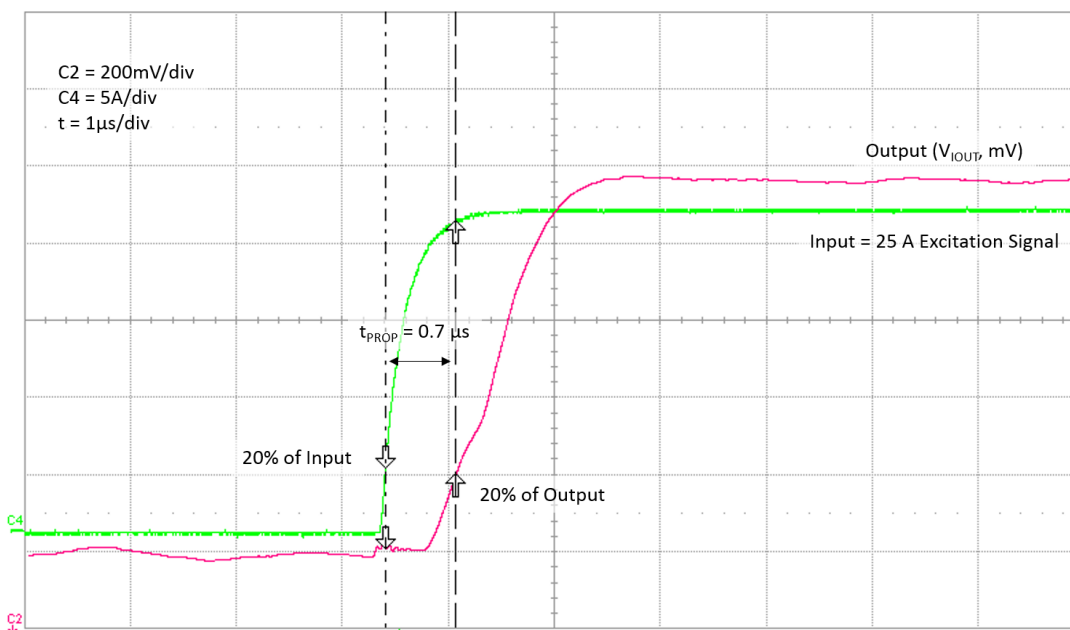

Rise Time (t_r)

25 A excitation signal with 10%-90% rise time = 1 μs

Sensitivity = 40 mV/A, $C_{\text{BYPASS}} = 0.1 \mu\text{F}$, $C_L = 1 \text{ nF}$

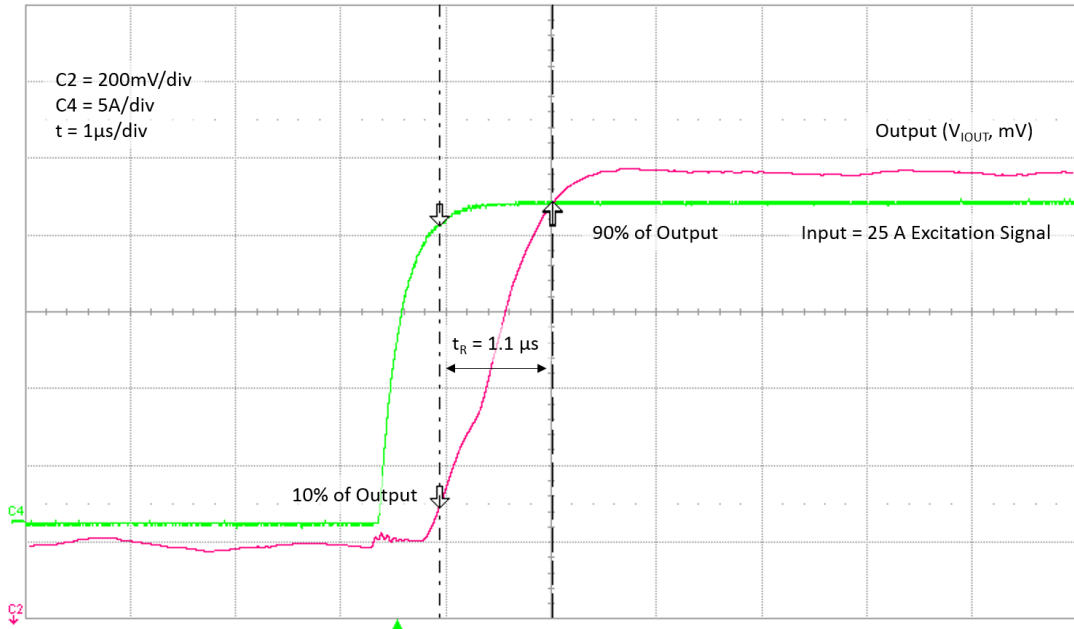

UVLO Enable Time (t_{UVLOE})

V_{CC} 5 V to 3 V fall time = 1.5 μ s

Sensitivity = 40 mV/A, C_{BYPASS} = 0.1 μ F, C_L = 1 nF

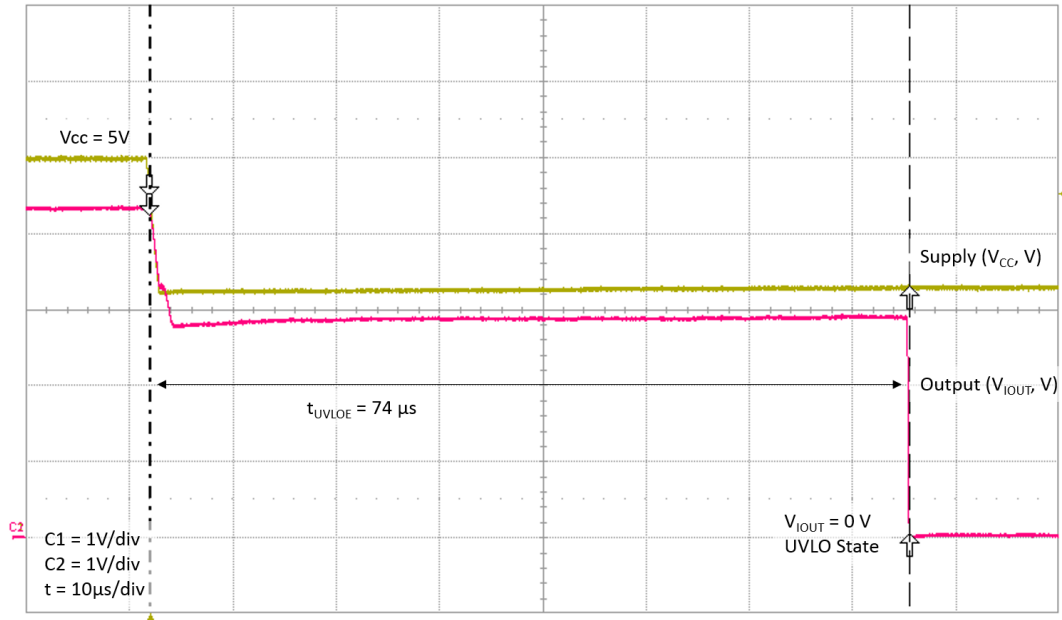

UVLO Disable Time (t_{UVLOD})

V_{CC} 3 V to 5 V recovery time = 1.5 μ s

Sensitivity = 40 mV/A, C_{BYPASS} = 0.1 μ F, C_L = 1 nF

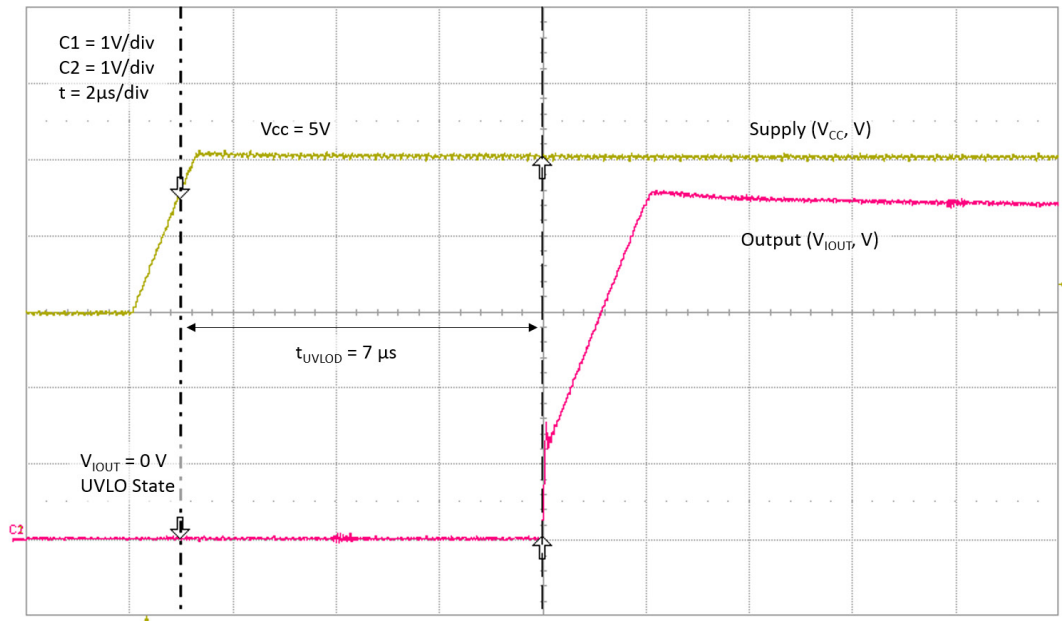

Power-On Example Curve

Sensitivity = 40 mV/A, $C_{BYPASS} = 0.1 \mu\text{F}$, $C_L = 1 \text{ nF}$, $R_{L(PULLUP)} = 4.7 \text{ k}\Omega$, $I_P = 50 \text{ A}$

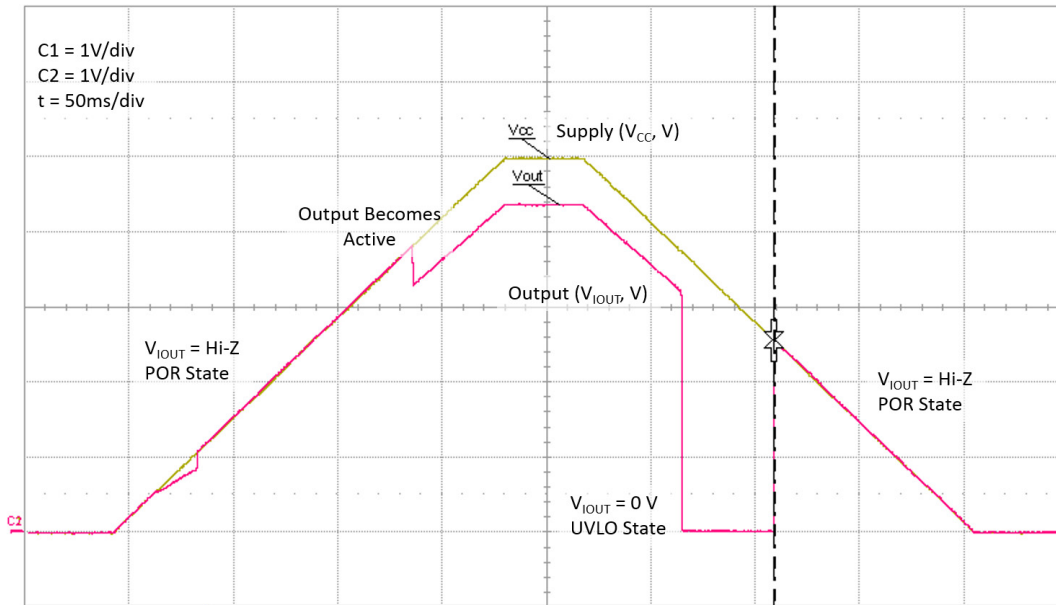

Power-On Time (t_{PO})

Sensitivity = 40 mV/A, $C_{BYPASS} = 0.1 \mu\text{F}$, $C_L = 1 \text{ nF}$, $I_P = 50 \text{ A}$

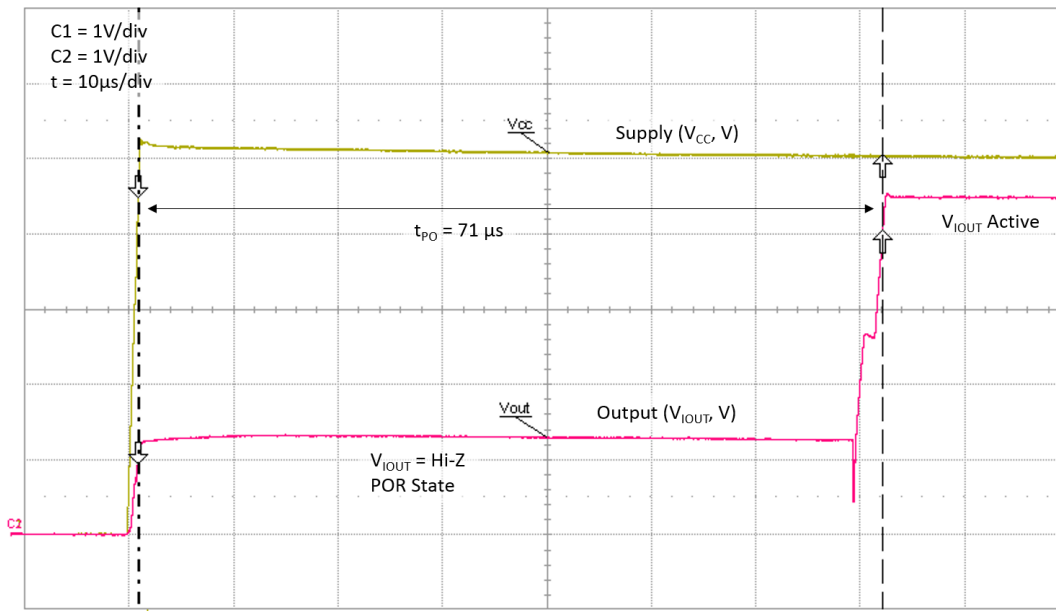

CHARACTERISTIC PERFORMANCE DATA ACS72981LLRATR-050B3

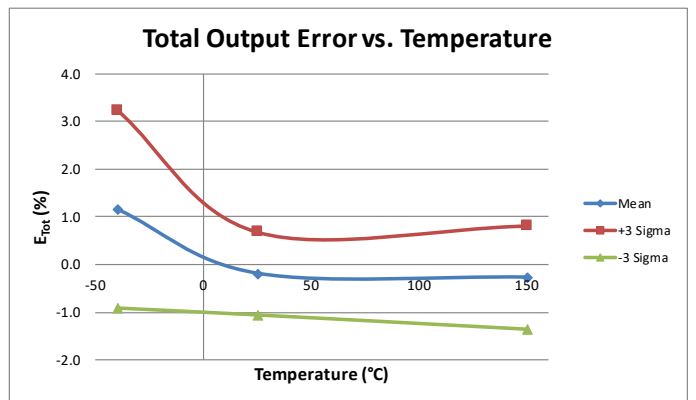
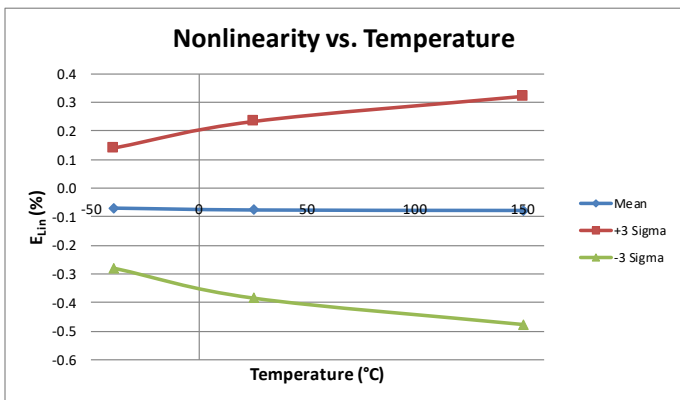
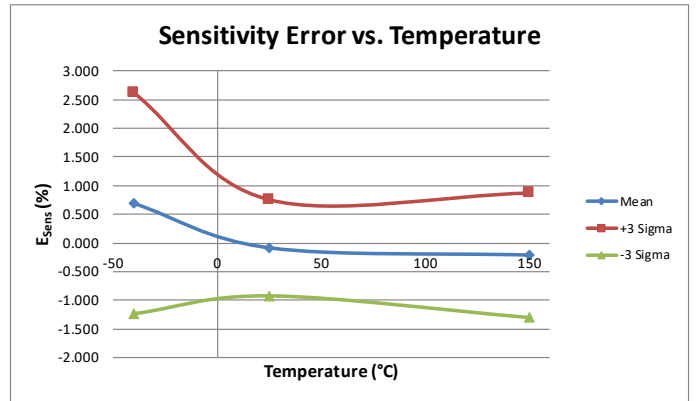
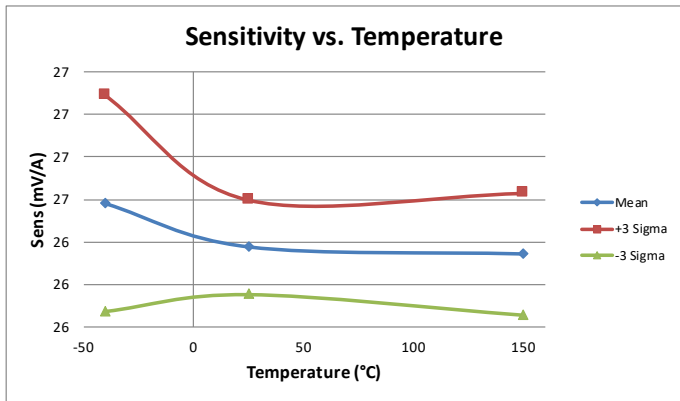
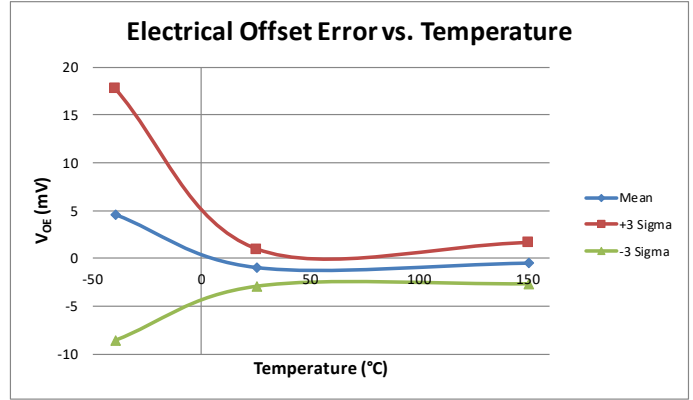
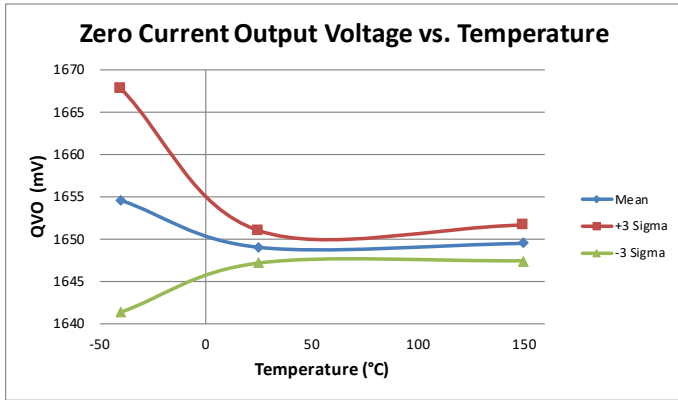

CHARACTERISTIC PERFORMANCE DATA ACS72981LLRATR-050B5

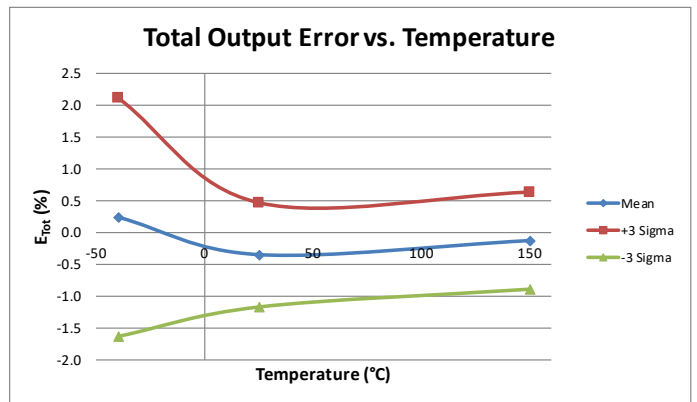
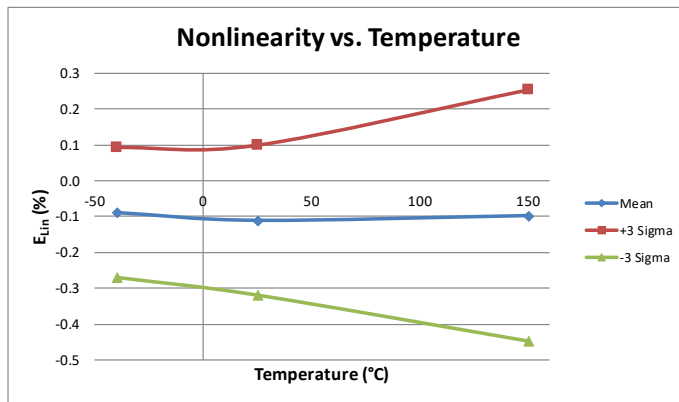
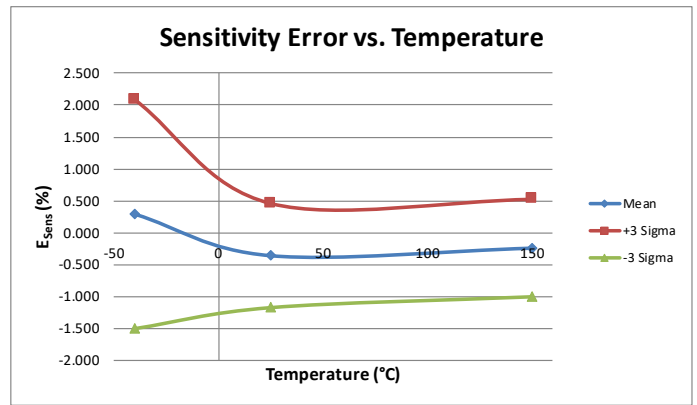
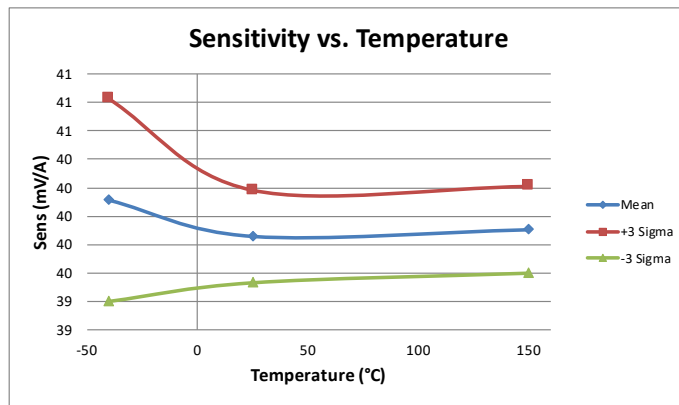
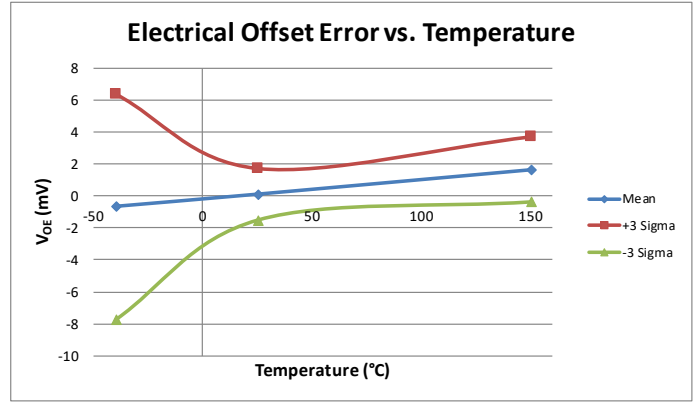
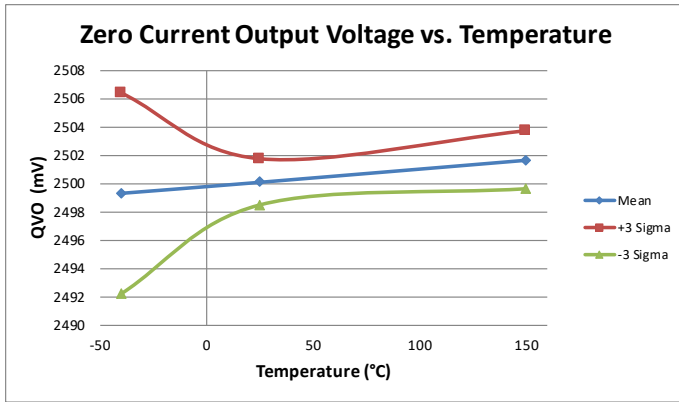

CHARACTERISTIC PERFORMANCE DATA ACS72981LLRATR-050U3

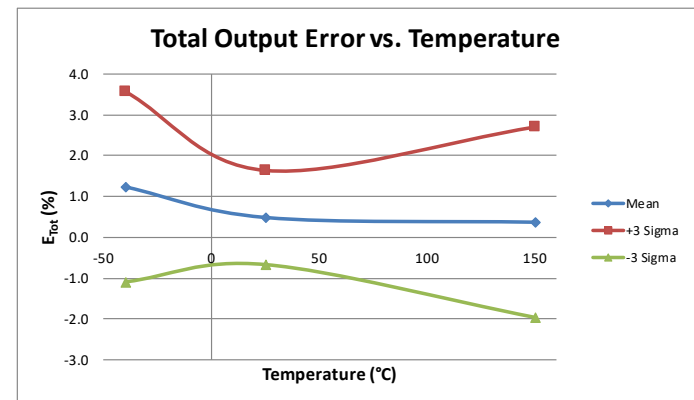
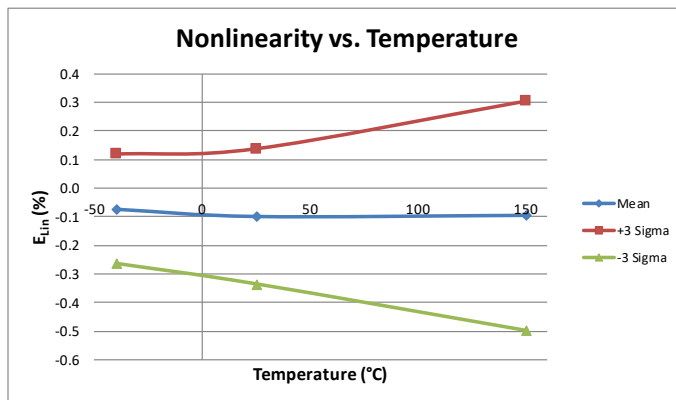
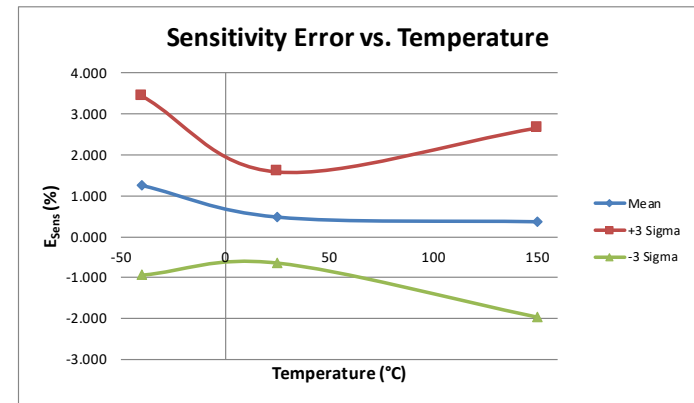
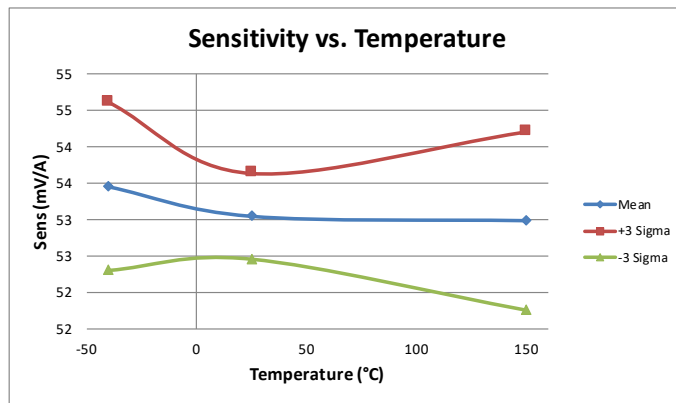
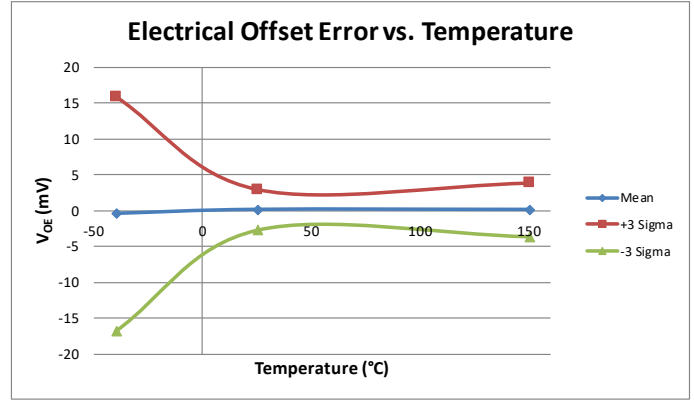
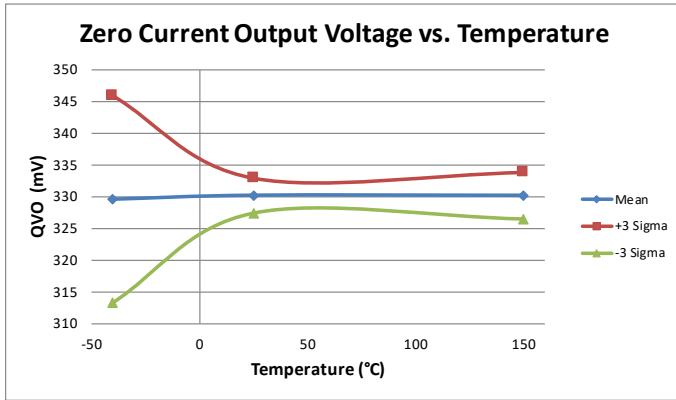

CHARACTERISTIC PERFORMANCE DATA ACS72981LLRATR-050U5

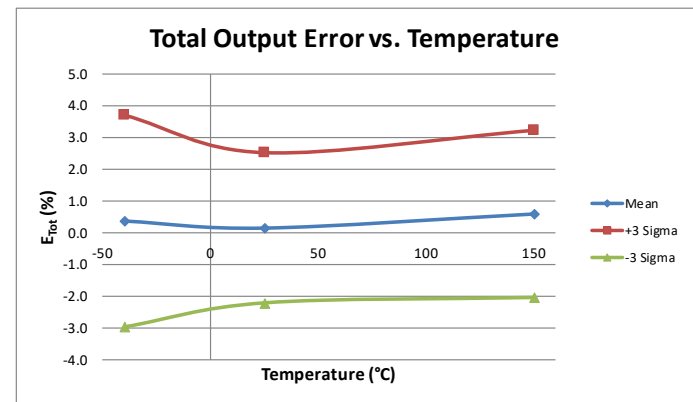
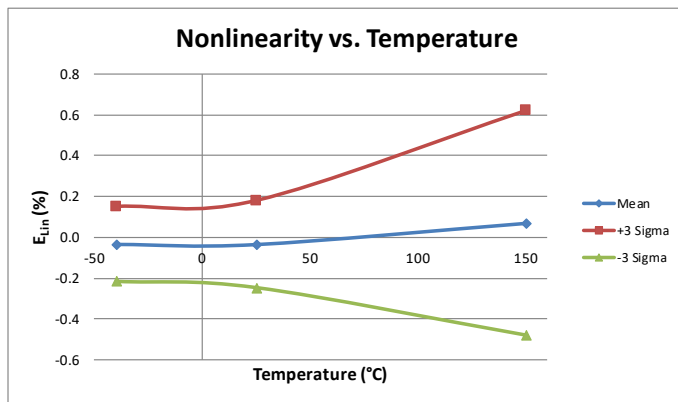
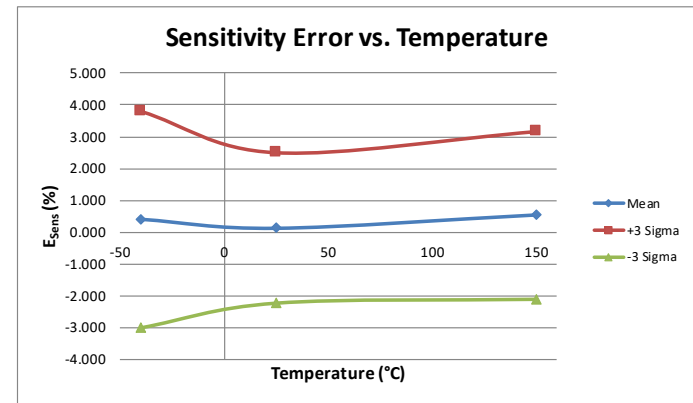
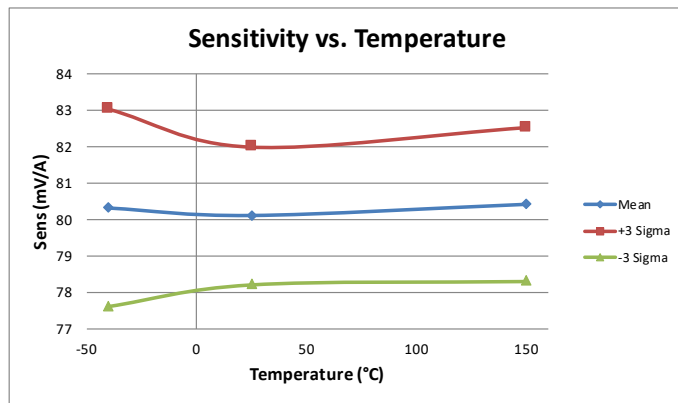
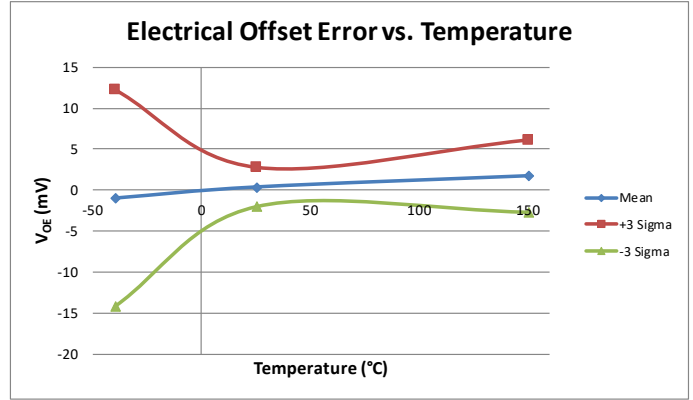
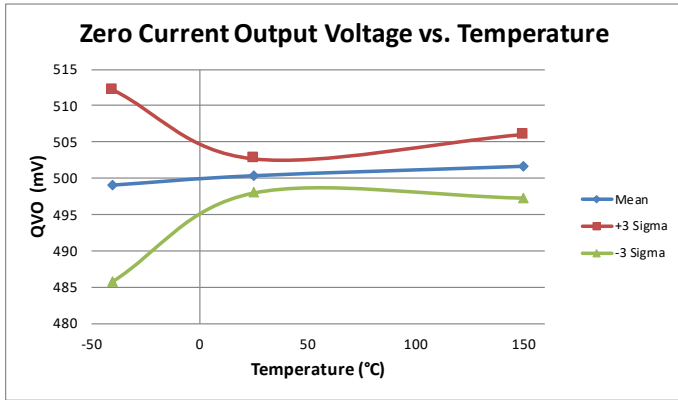

CHARACTERISTIC PERFORMANCE DATA ACS72981LLRATR-100B3

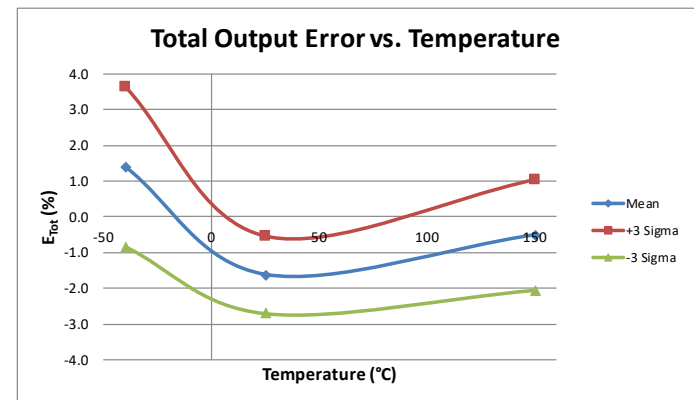
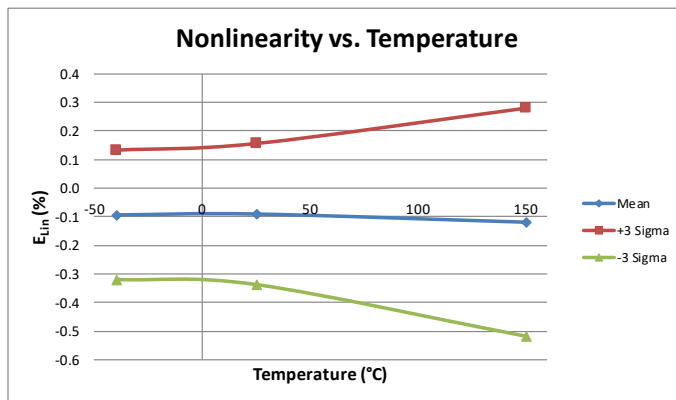
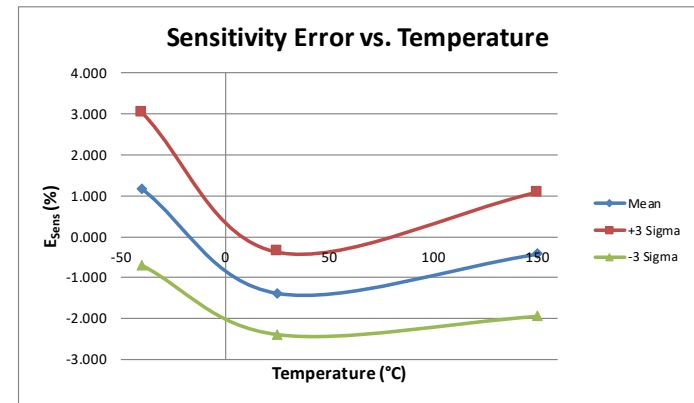
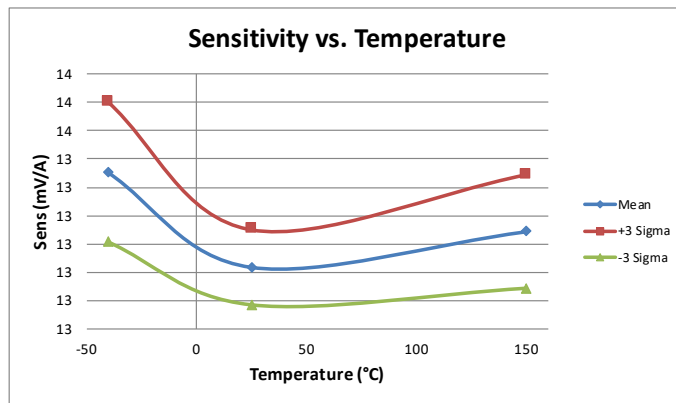
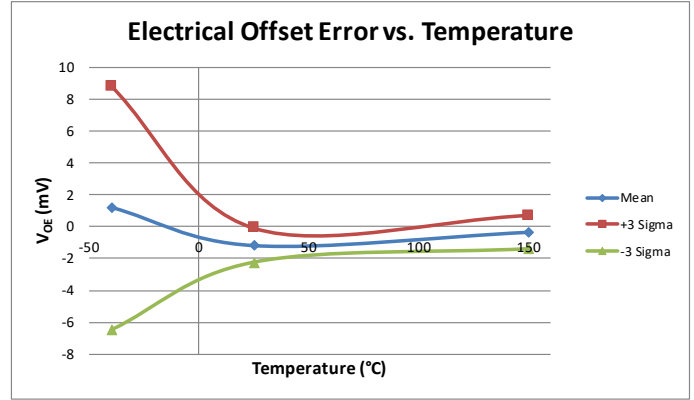
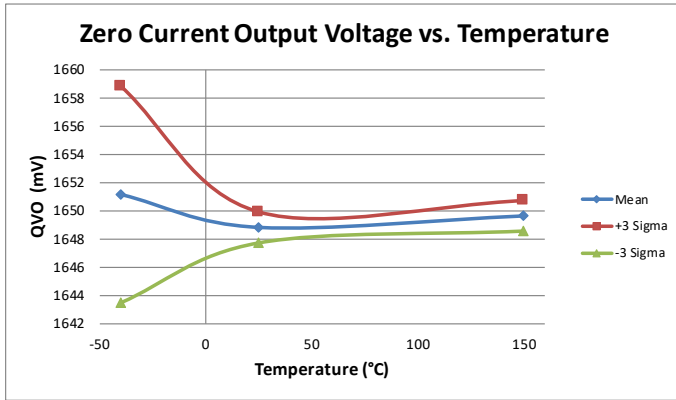

CHARACTERISTIC PERFORMANCE DATA ACS72981LLRATR-100B5

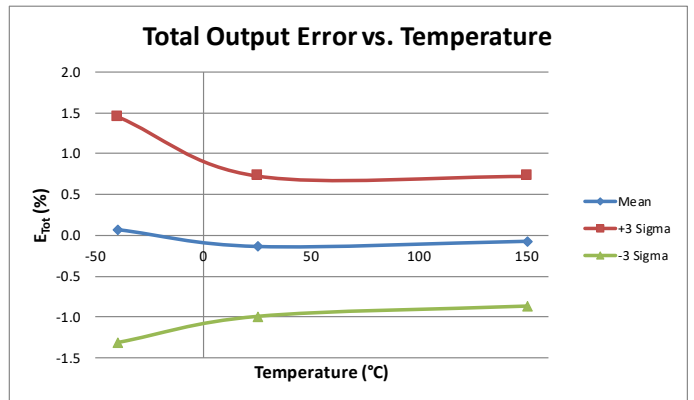
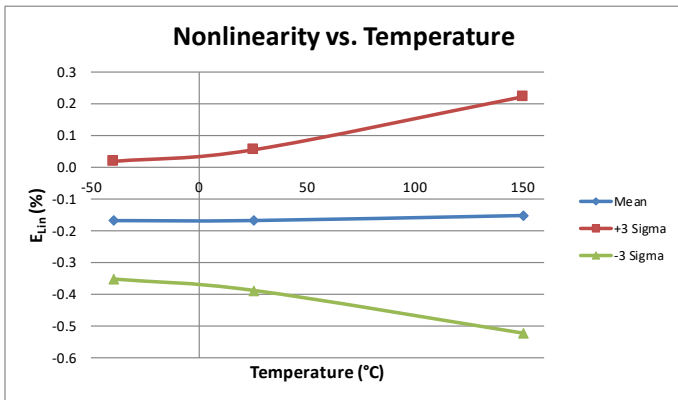
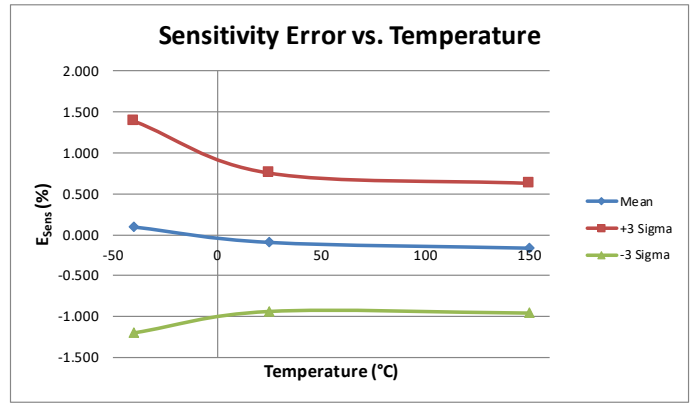
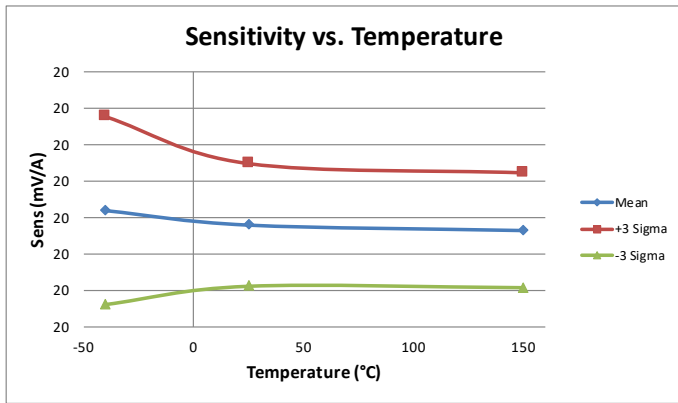
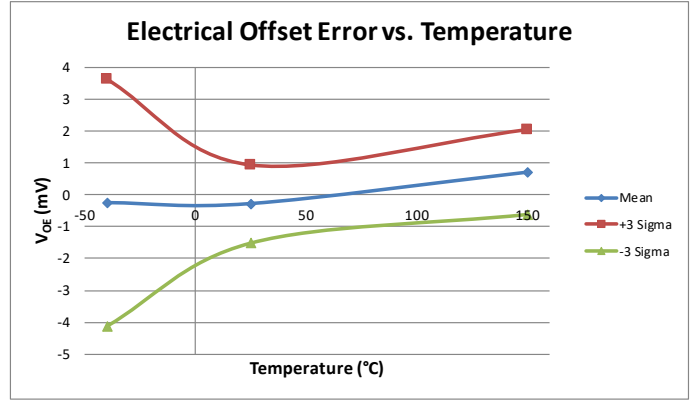
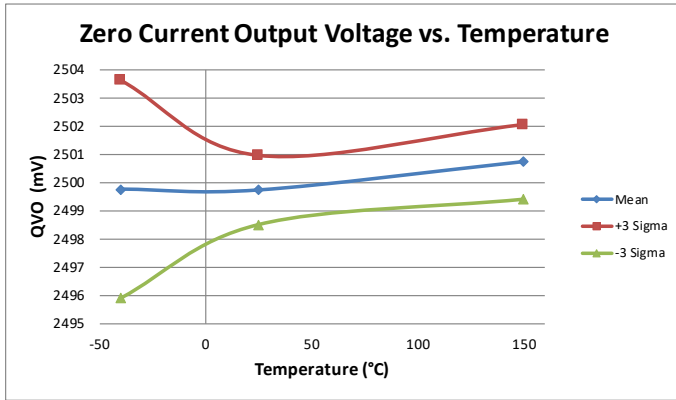

CHARACTERISTIC PERFORMANCE DATA ACS72981LLRATR-100U3

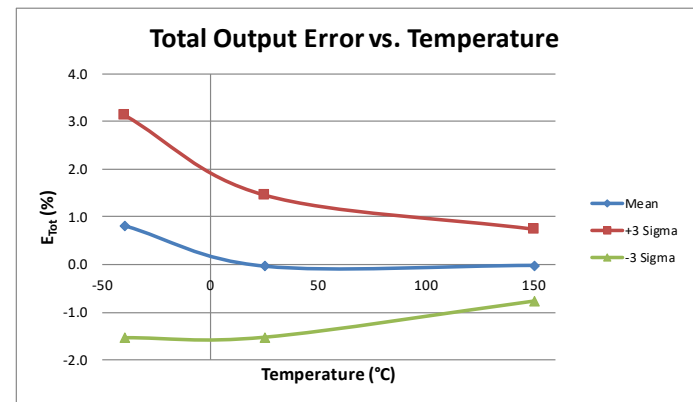
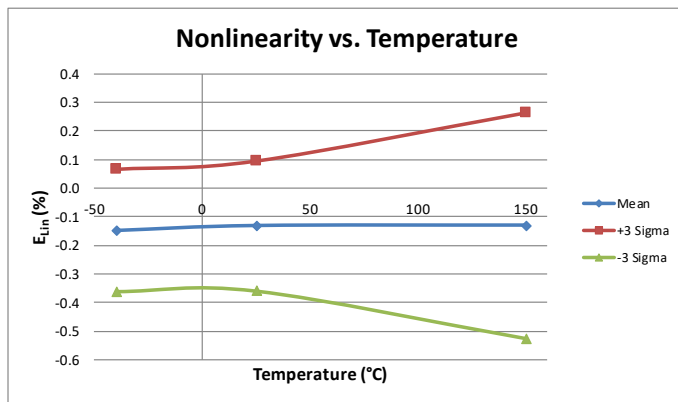
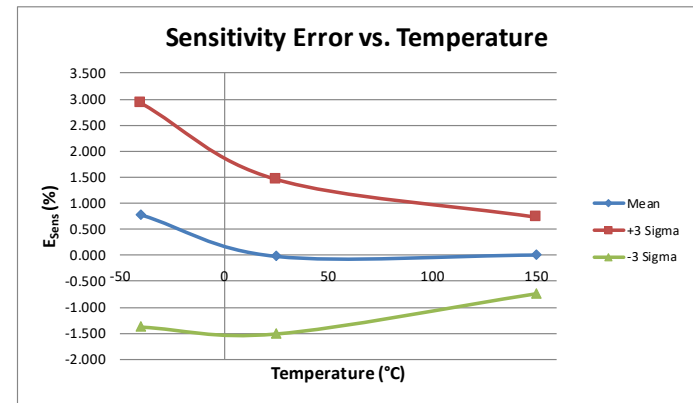
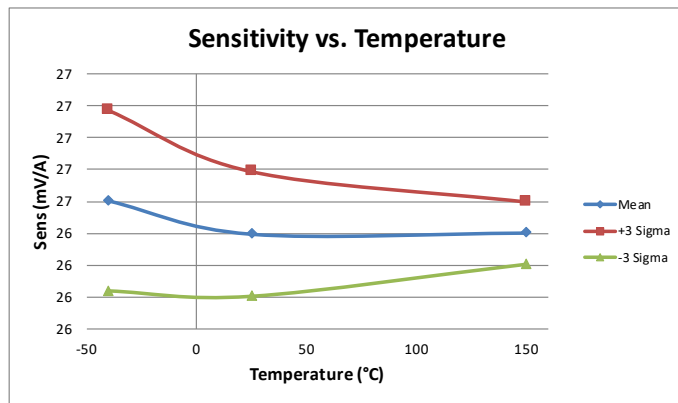
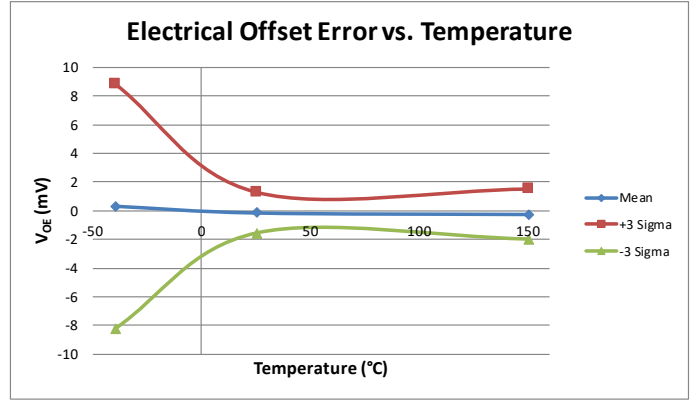
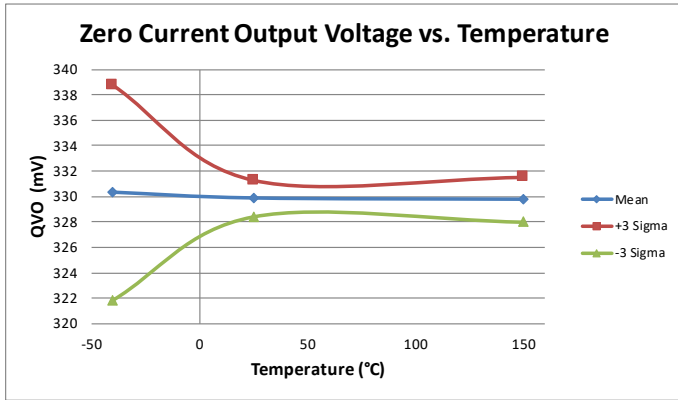

CHARACTERISTIC PERFORMANCE DATA ACS72981LLRATR-100U5

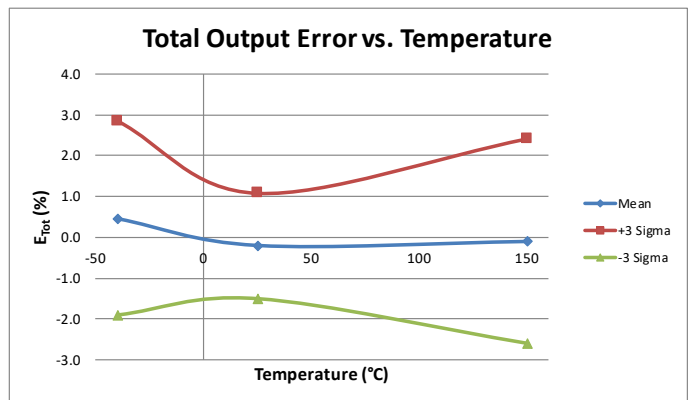
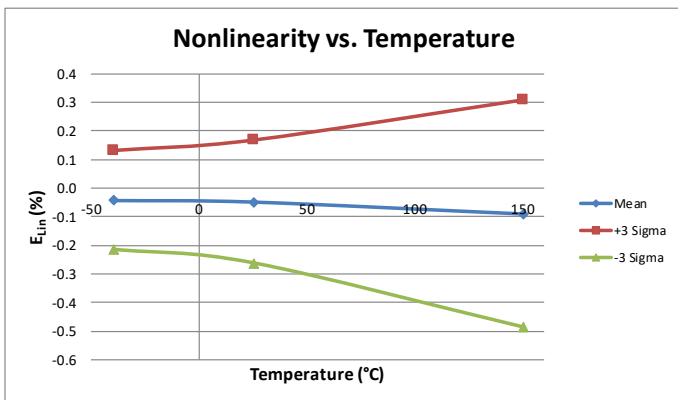
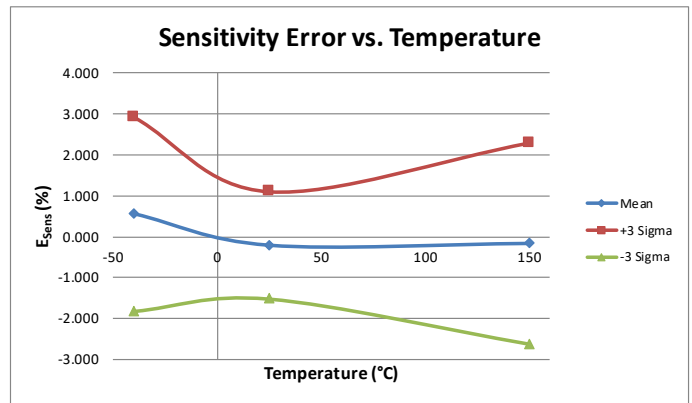
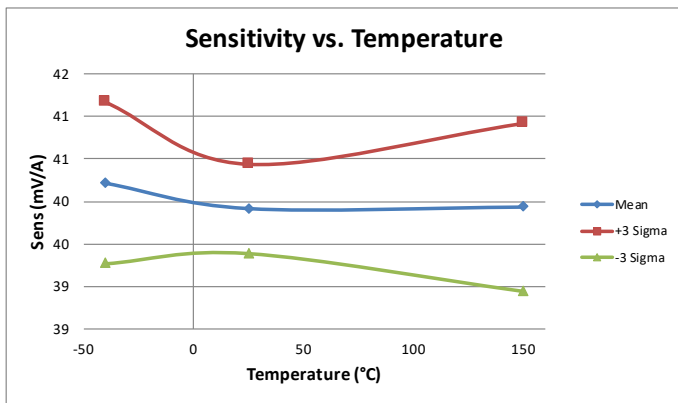
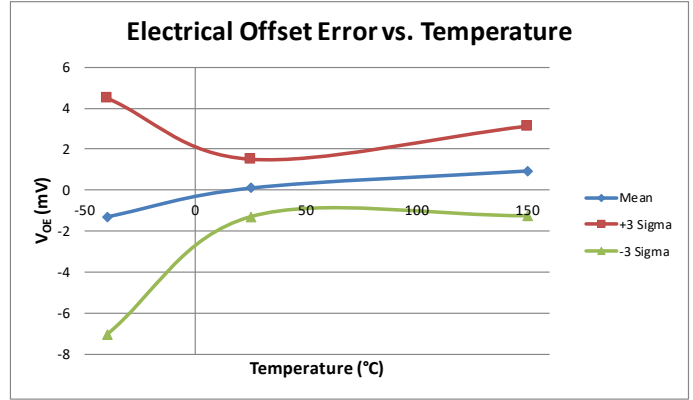
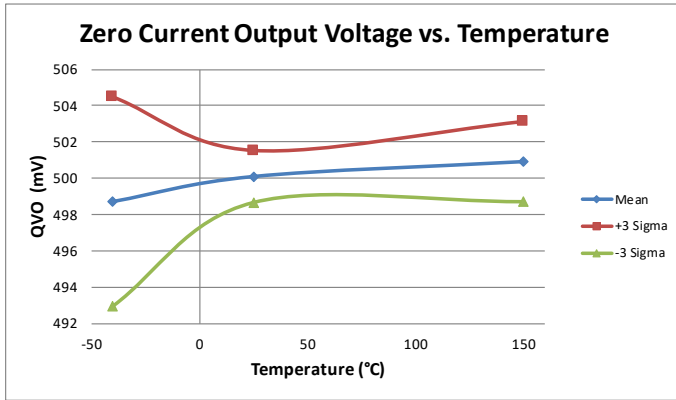

CHARACTERISTIC PERFORMANCE DATA ACS72981KLRATR-150B3

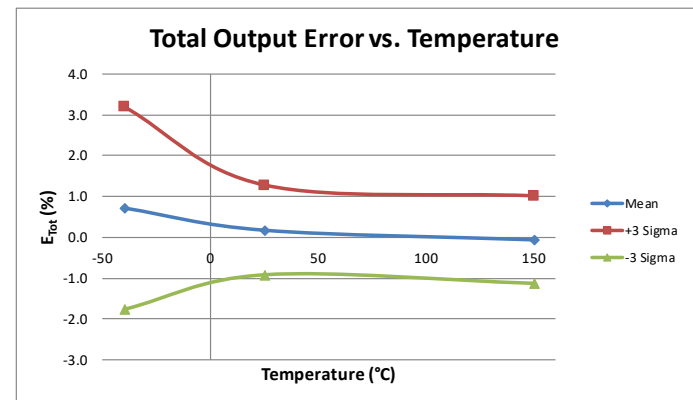
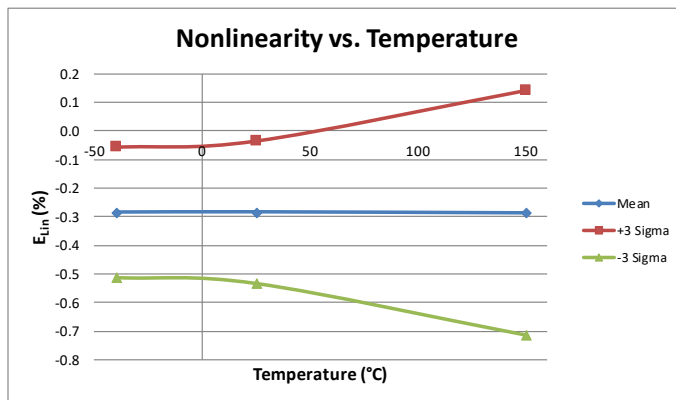
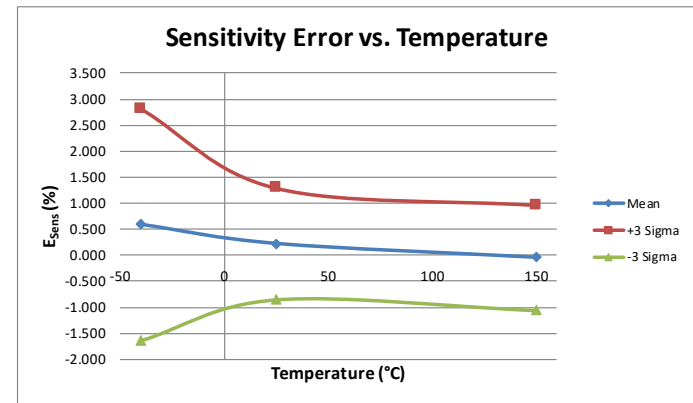
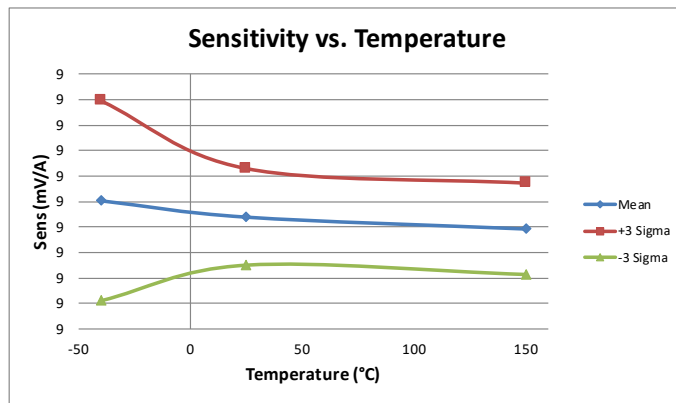
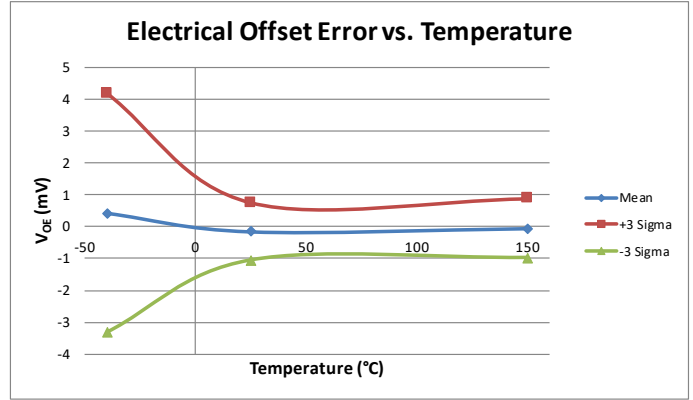
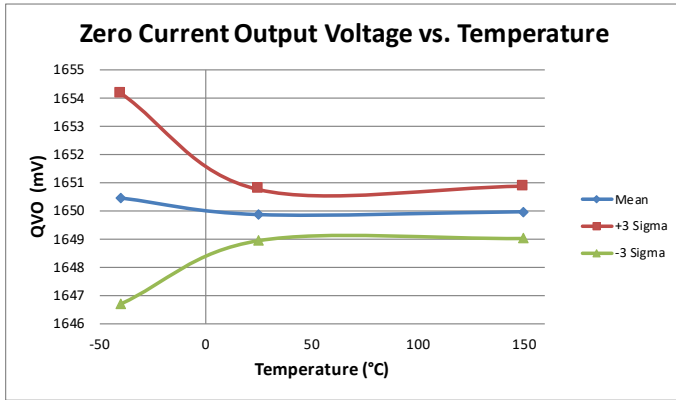

CHARACTERISTIC PERFORMANCE DATA ACS72981KLRATR-150B5

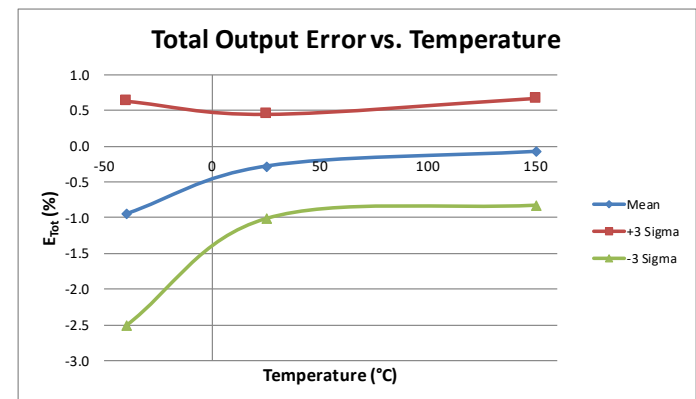
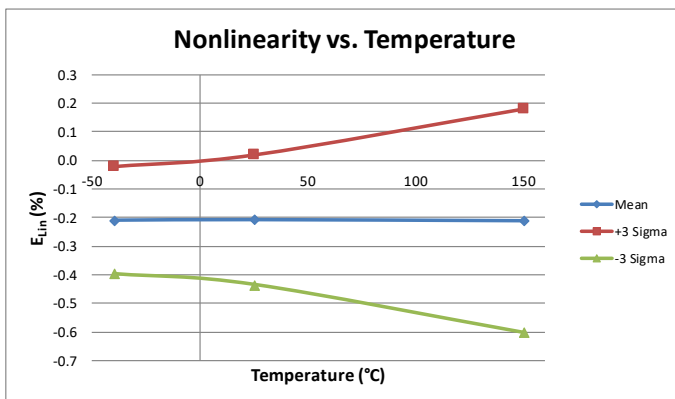
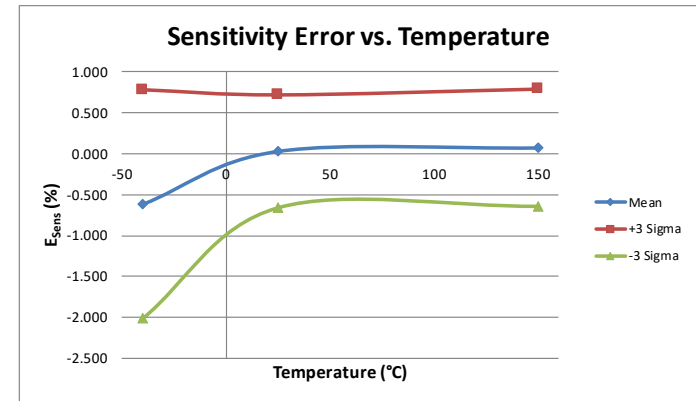
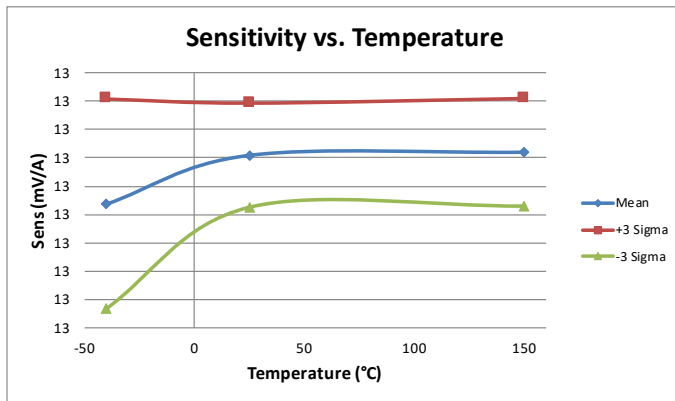
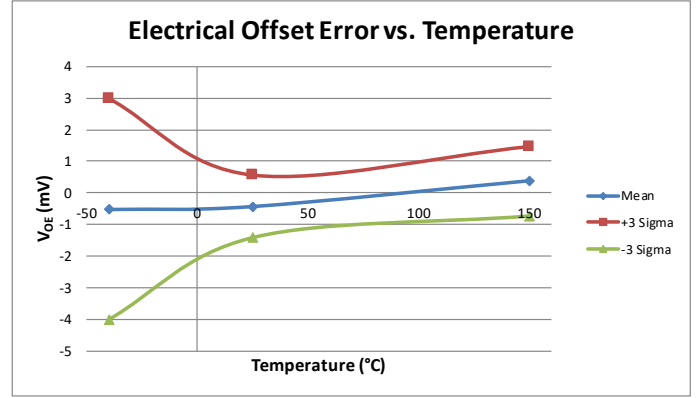
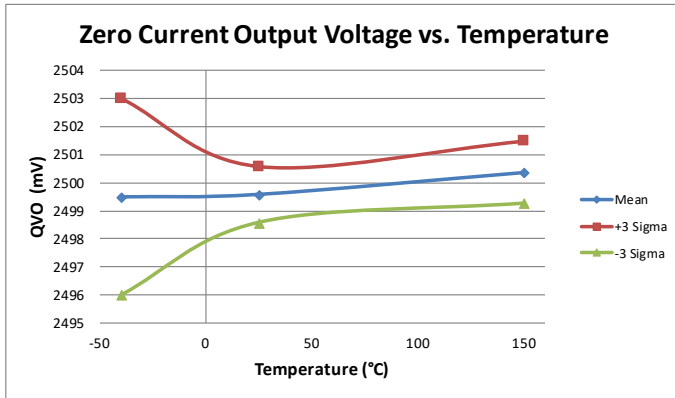

CHARACTERISTIC PERFORMANCE DATA ACS72981KLRATR-150U3

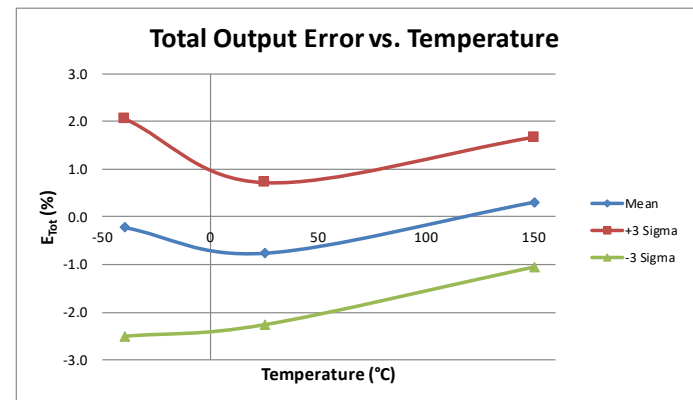
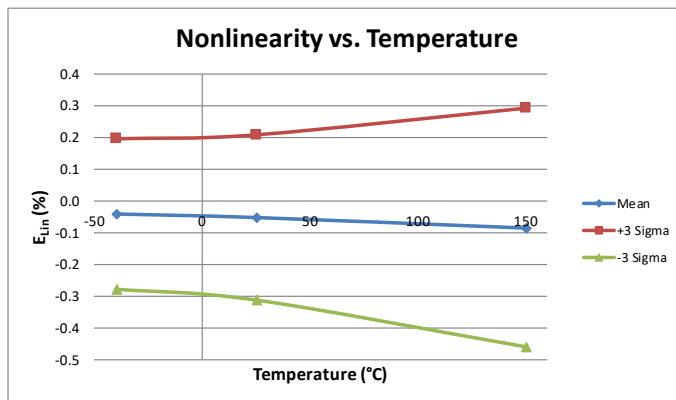
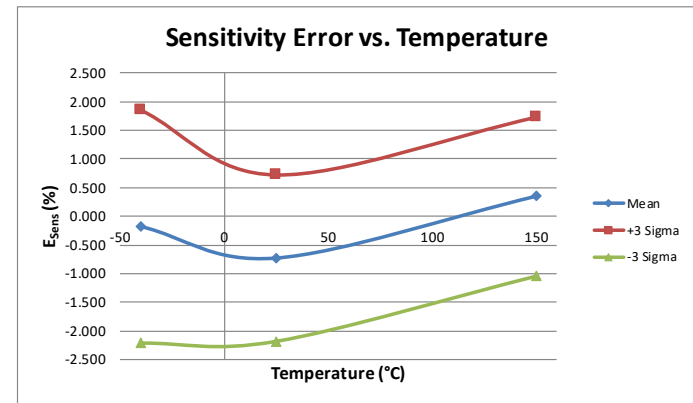
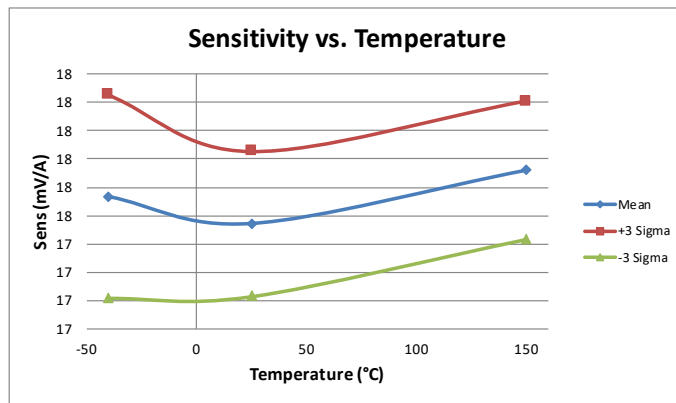
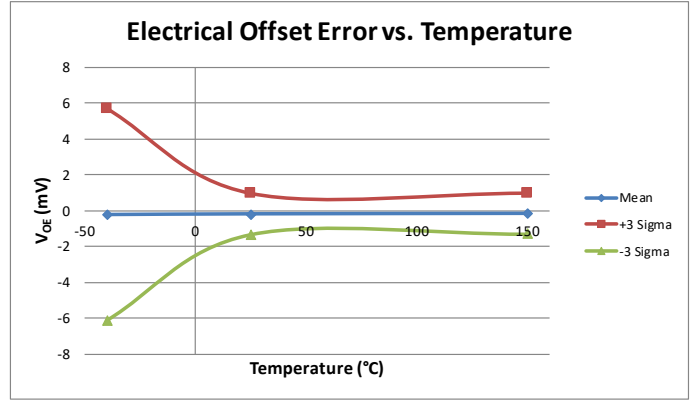
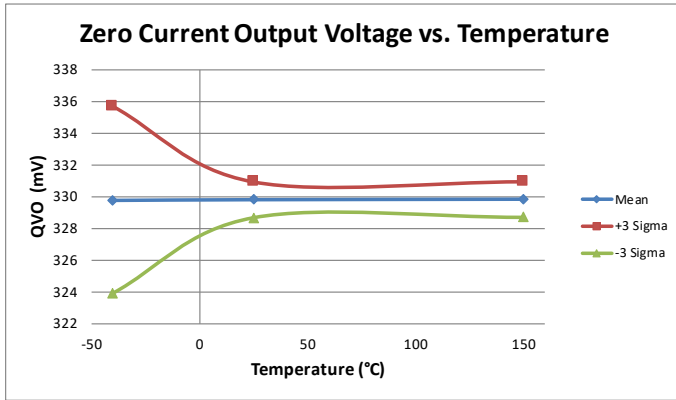

CHARACTERISTIC PERFORMANCE DATA ACS72981KLRATR-150U5

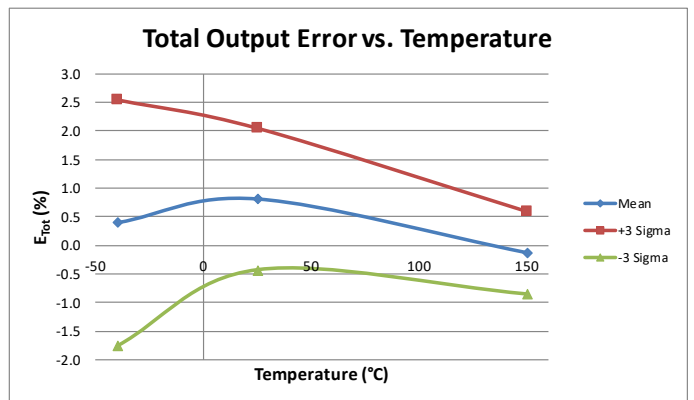
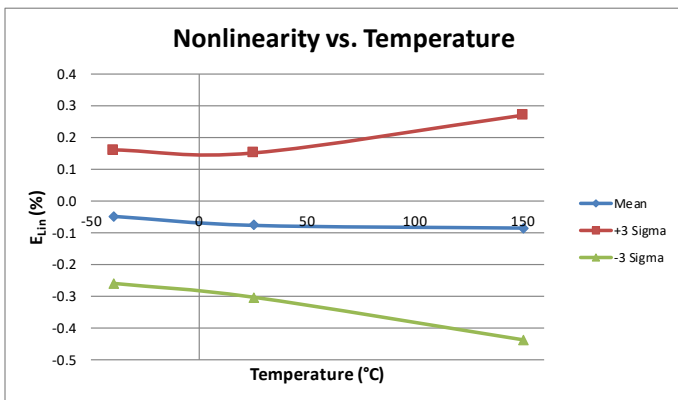
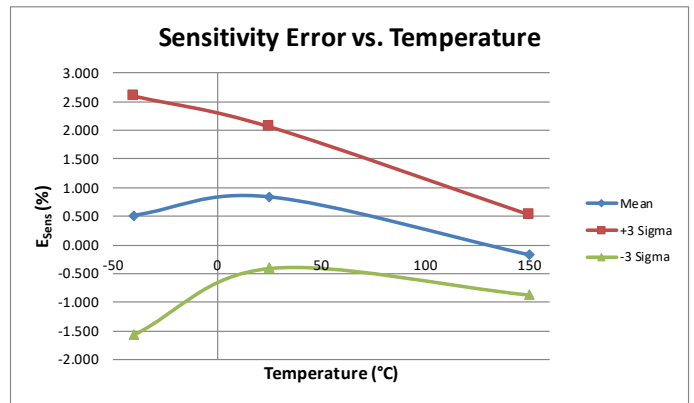
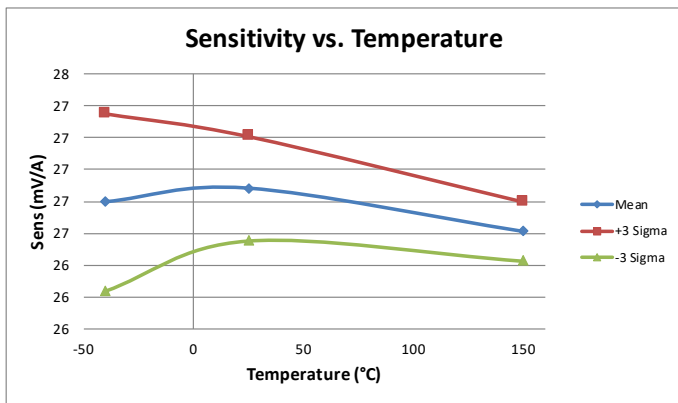
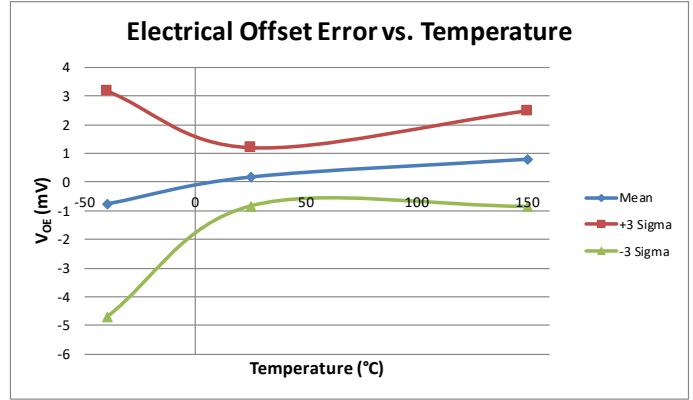
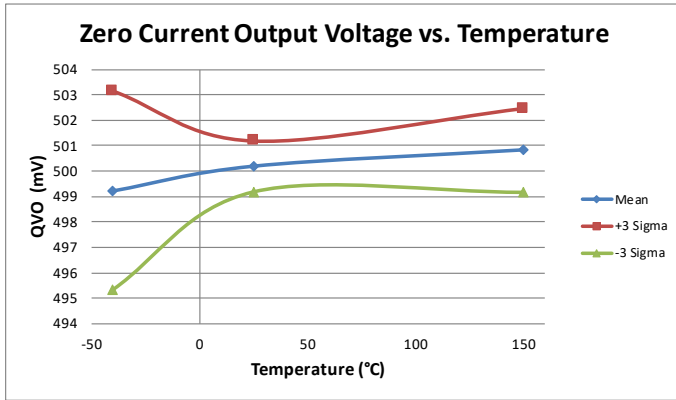

CHARACTERISTIC PERFORMANCE DATA ACS72981ELRATR-200U3

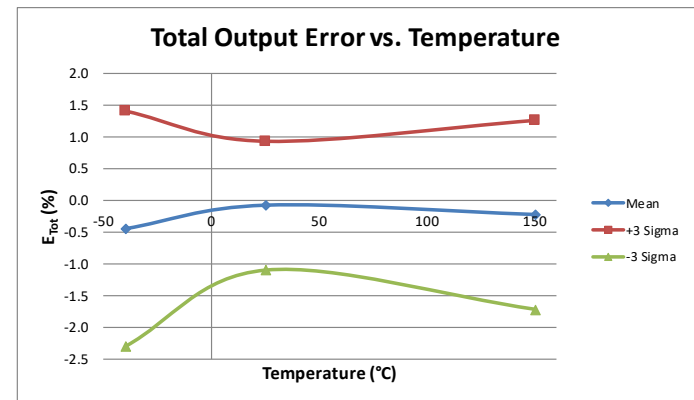
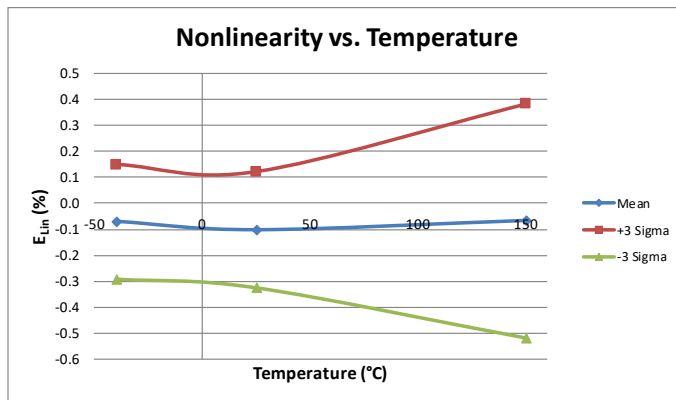
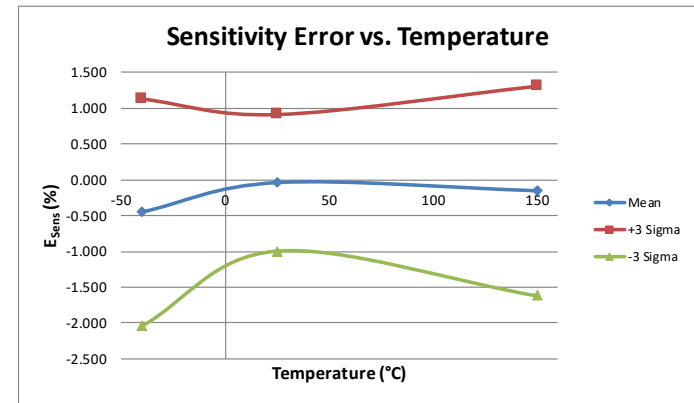
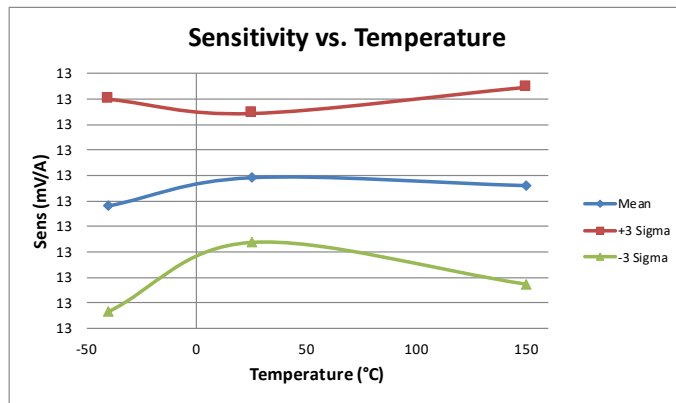
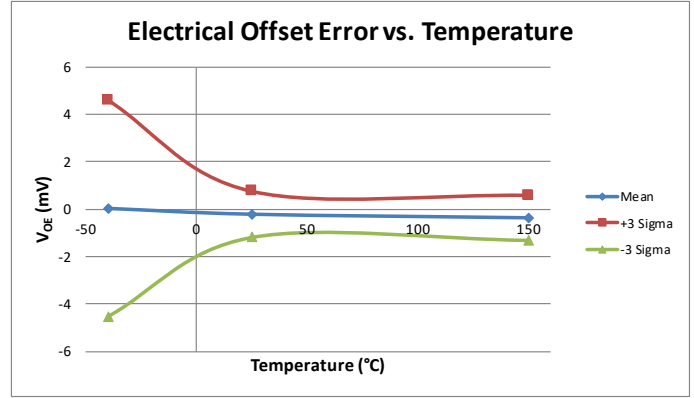
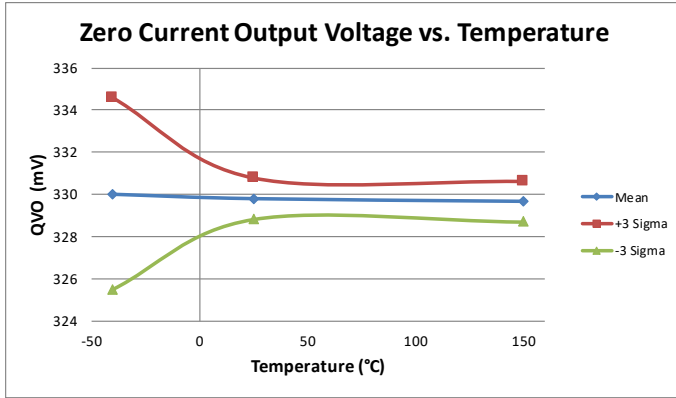

CHARACTERISTIC PERFORMANCE DATA ACS72981ELRATR-200U5

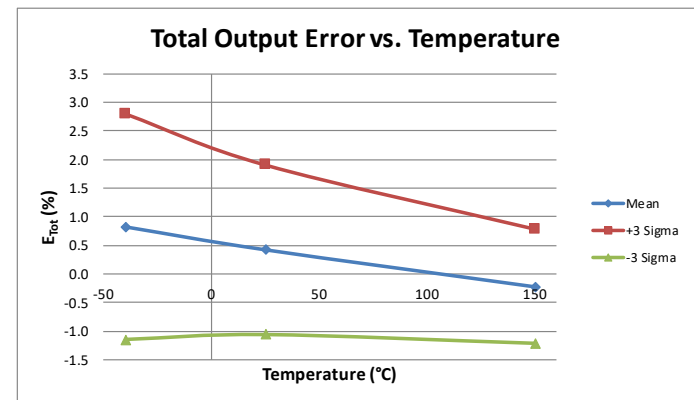
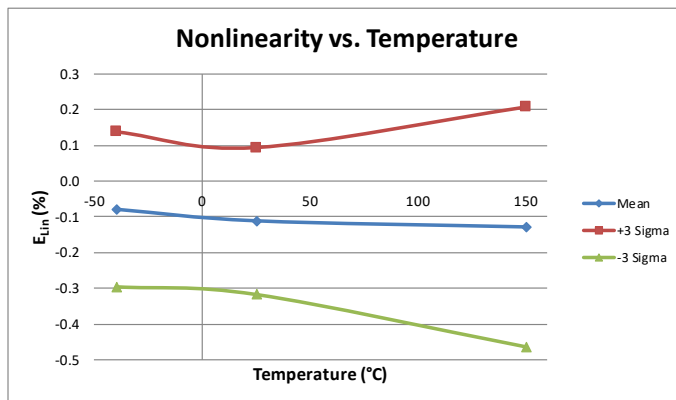
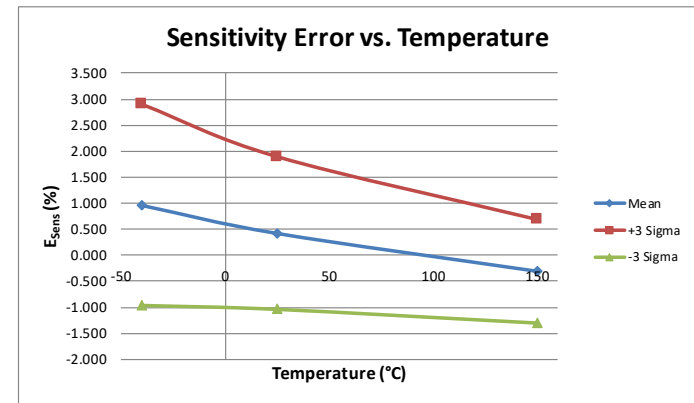
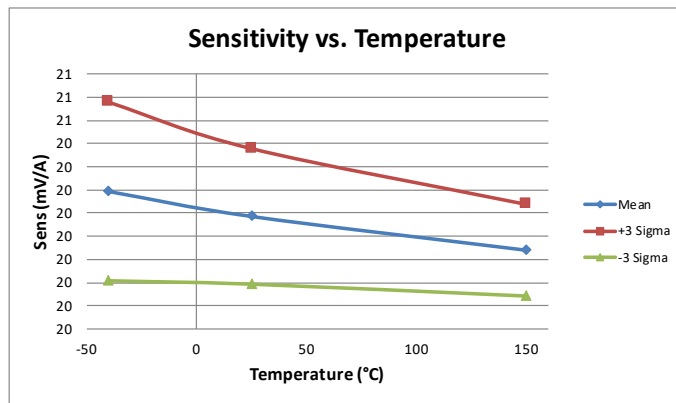
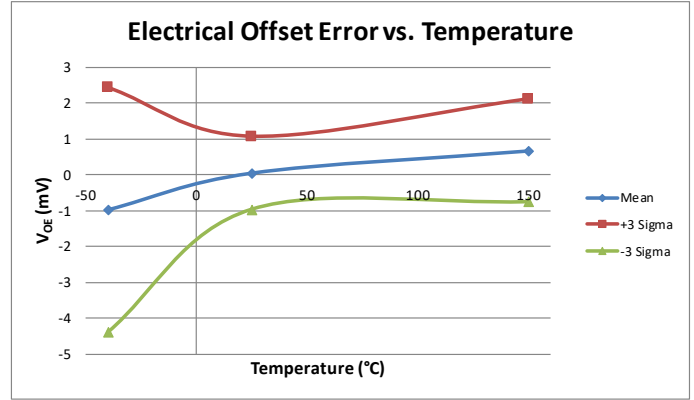
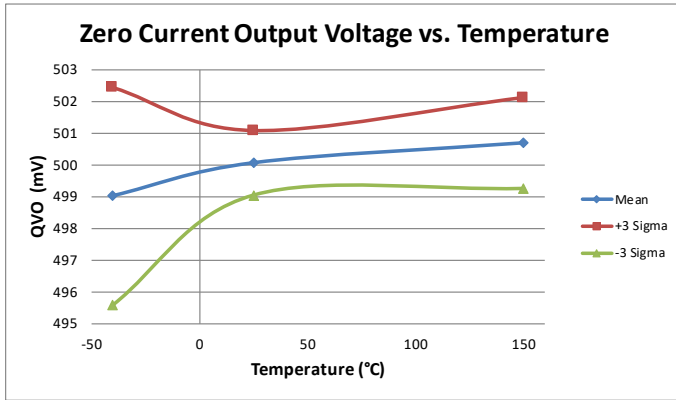

CHARACTERISTIC PERFORMANCE DATA ACS72981ELRATR-200B3

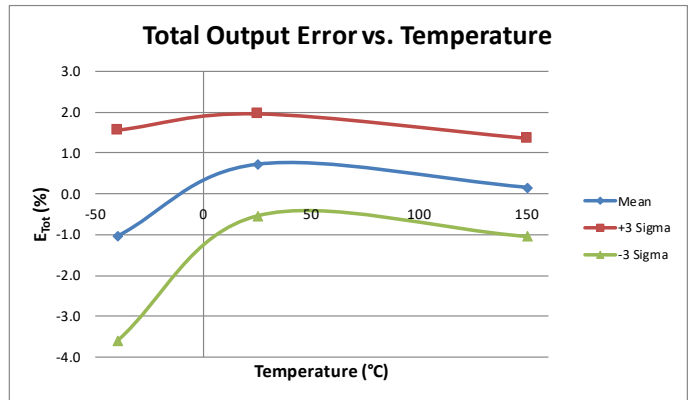
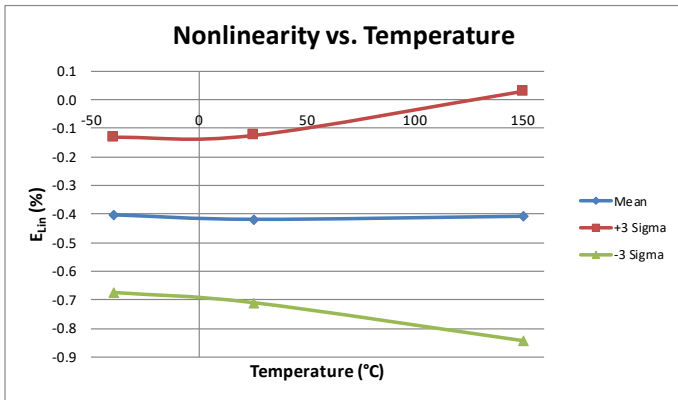
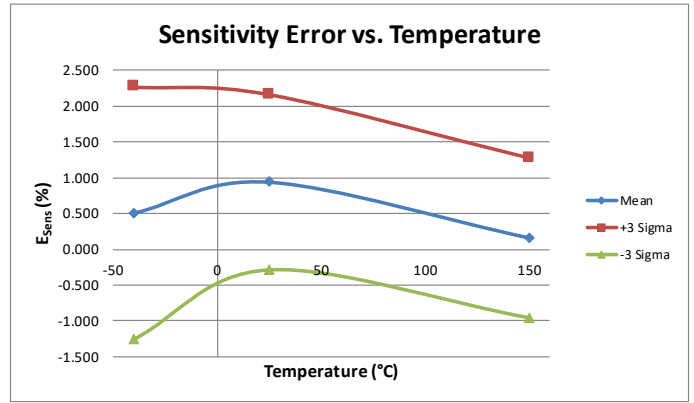
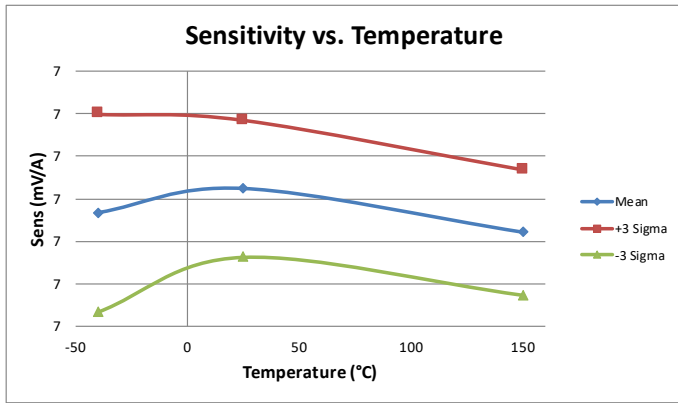
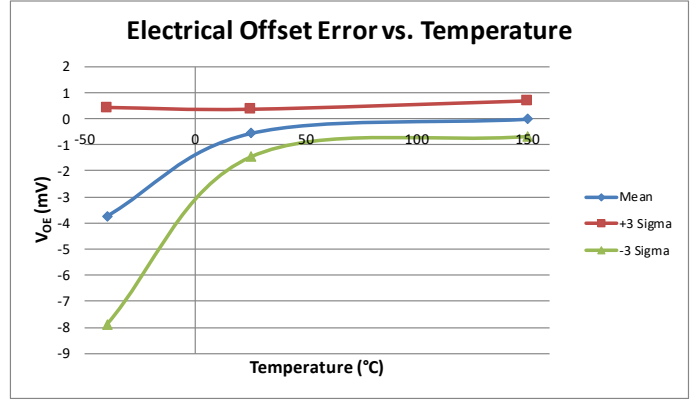
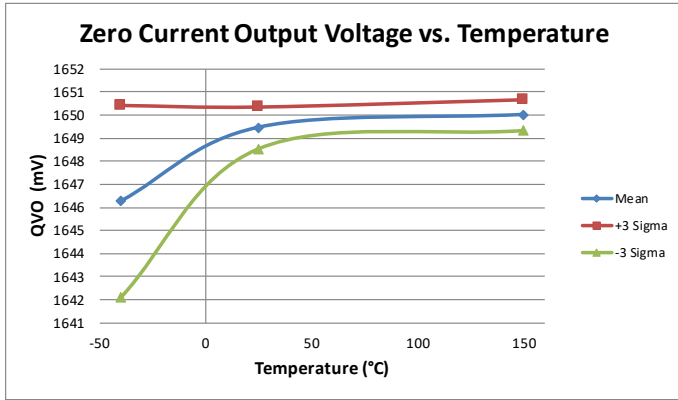

CHARACTERISTIC PERFORMANCE DATA ACS72981ELRATR-200B5

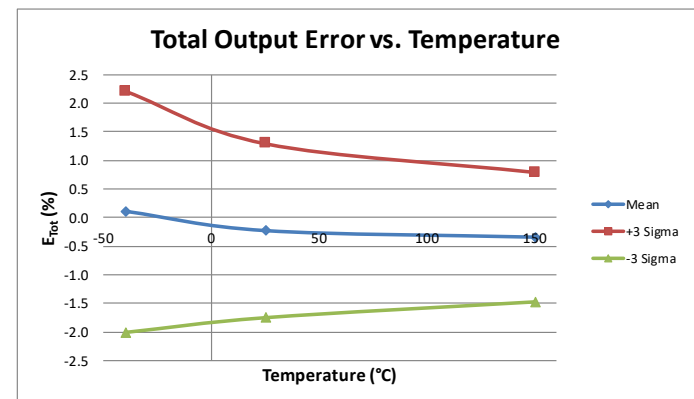
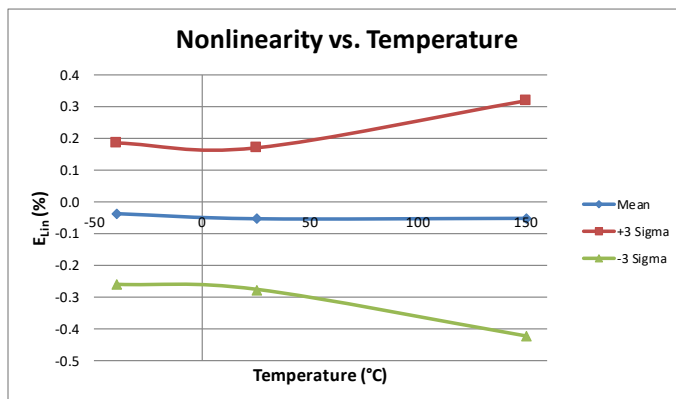
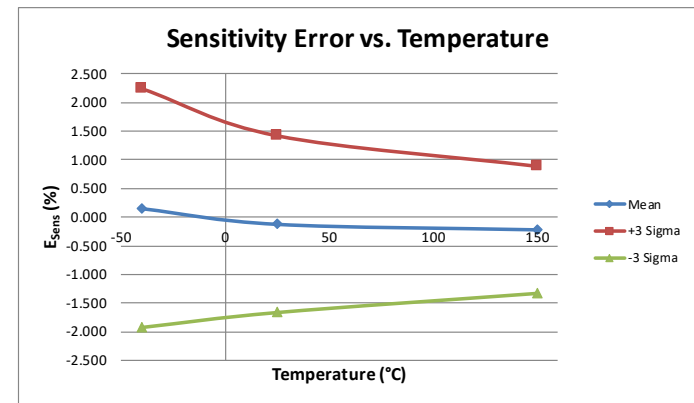
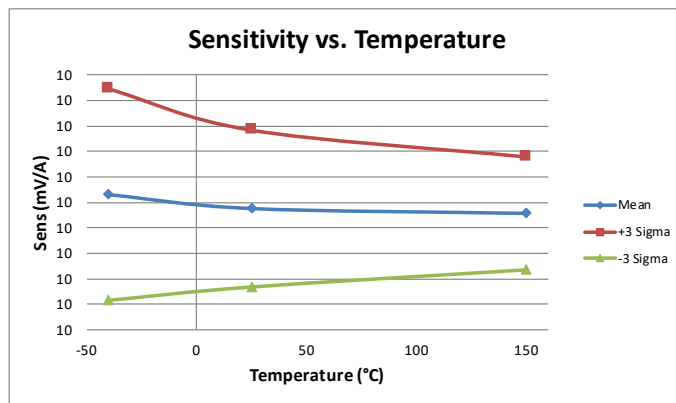
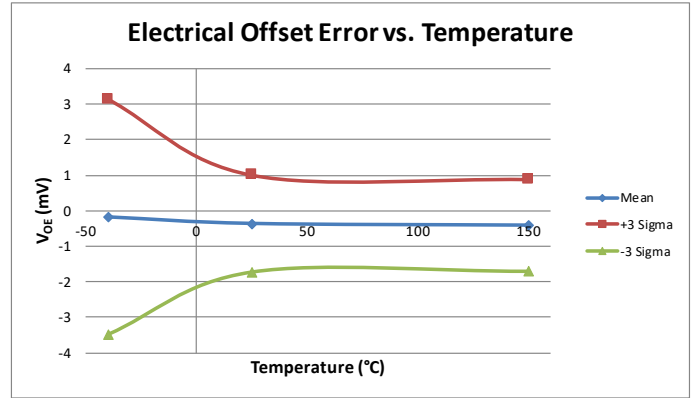
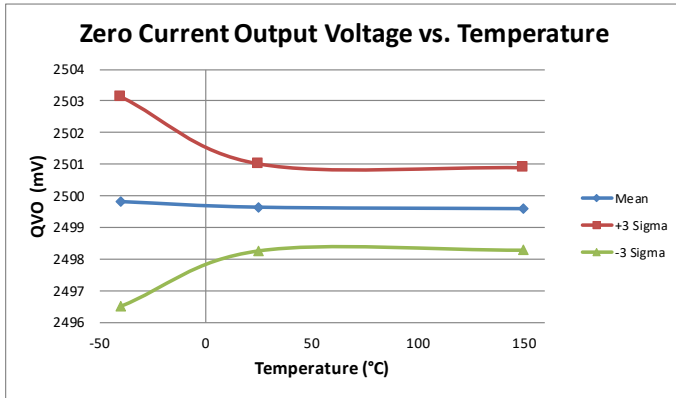

CHARACTERISTIC PERFORMANCE TYPICAL FREQUENCY RESPONSE

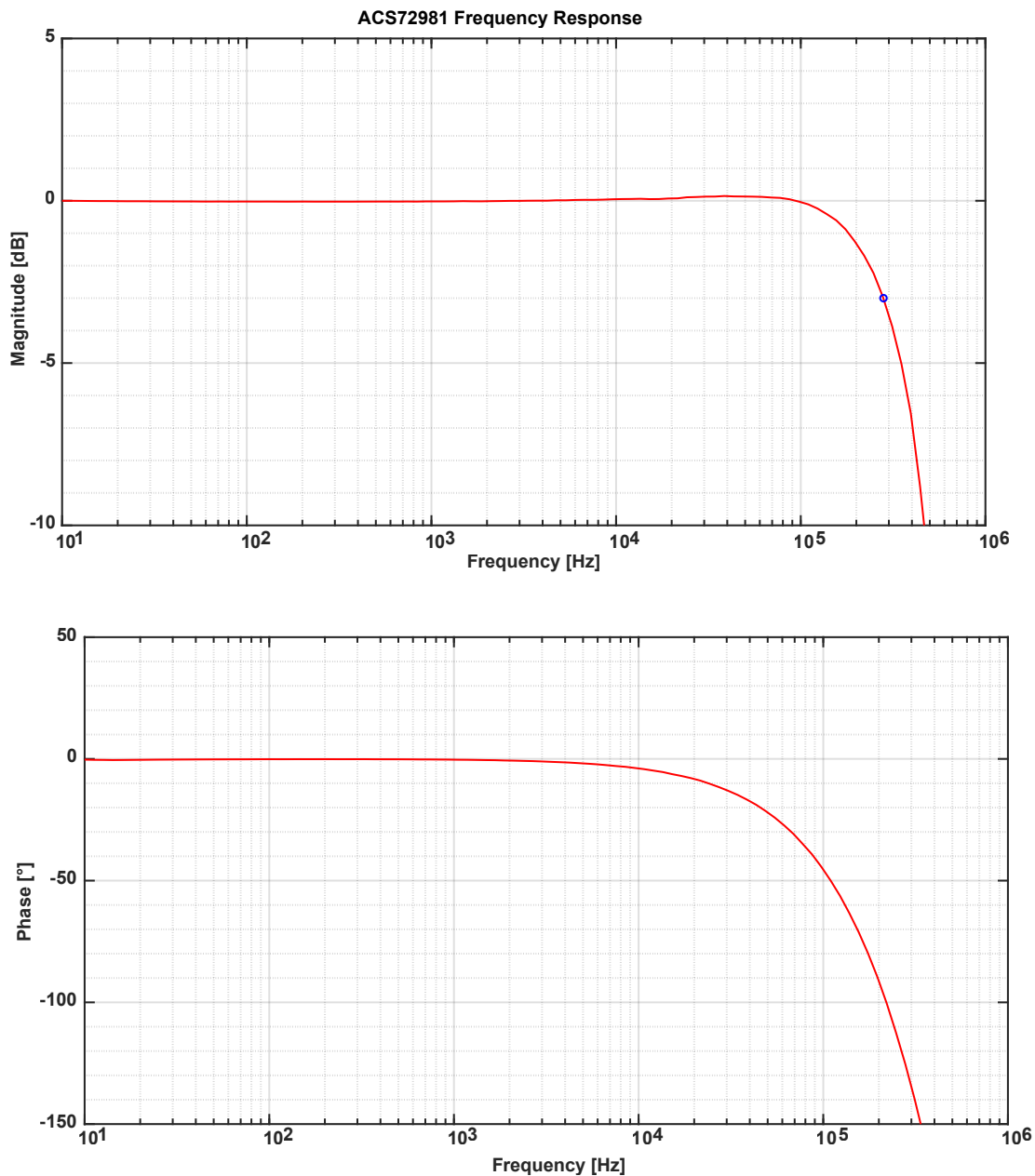

For information regarding bandwidth characterization methods used for the ACS72981, see the “Characterizing System Bandwidth” application note (<https://allegromicro.com/en/insights-and-innovations/technical-documents/hall-effect-sensor-ic-publications/an296169-ac720-bandwidth-testing>) on the Allegro website.

CHARACTERISTIC DEFINITIONS

Definitions of Accuracy Characteristics

SENSITIVITY (Sens)

The change in sensor IC output in response to a 1 A change through the primary conductor. The sensitivity is the product of the magnetic circuit sensitivity (G/A) (1 G = 0.1 mT) and the linear IC amplifier gain (mV/G). The linear IC amplifier gain is programmed at the factory to optimize the sensitivity (mV/A) for the full-scale current of the device.

$$\text{Sens} = \frac{V_{\text{OUT}}(\text{IP}_1) - V_{\text{OUT}}(\text{IP}_2)}{\text{IP}_1 - \text{IP}_2}$$

SENSITIVITY ERROR (E_{Sens})

The sensitivity error is the percent difference between the measured sensitivity and the ideal sensitivity. For example, in the case of $V_{\text{CC}} = 5 \text{ V}$:

$$E_{\text{Sens}} = \frac{\text{Sens}_{\text{Meas}}(5\text{V}) - \text{Sens}_{\text{Ideal}}(5\text{V})}{\text{Sens}_{\text{IDEAL}}(5\text{V})} \times 100 (\%)$$

NOISE (V_{N})

The noise floor is derived from the thermal and shot noise observed in Hall elements. Dividing the noise (mV) by the sensitivity (mV/A) provides the smallest current that the device is able to resolve.

NONLINEARITY (E_{LIN})

The nonlinearity is a measure of how linear the output of the sensor IC is over the full current measurement range. The nonlinearity is calculated as:

$$E_{\text{LIN}} = \left\{ 1 - \left[\frac{\text{Sens}_{\text{IPR}(\text{MAX})}}{\text{Sens}_{\text{IPR}(\text{HALF})}} \right] \right\} \times 100 (\%)$$

where $\text{Sens}_{\text{IPR}(\text{MAX})}$ is the output of the sensor IC with the maximum measurement current flowing through it and $\text{Sens}_{\text{IPR}(\text{HALF})}$ is the output of the sensor IC with half of the maximum measurement current flowing through it.

SYMMETRY (E_{SYM})

The degree to which the absolute voltage output from the IC varies in proportion to either a positive or negative half-scale primary current. The following equation is used to derive symmetry:

$$E_{\text{SYM}} = \left\{ 1 - \left[\frac{\text{Sens}_{\text{IPR}(\text{HALF})}}{\text{Sens}_{\text{IPR}(-\text{HALF})}} \right] \right\} \times 100 (\%)$$

RATIOMETRY

The device features a ratiometric output. This means that the quiescent voltage output, $V_{\text{IOUT}(\text{Q})}$, and the magnetic sensitivity, Sens, are proportional to the supply voltage, V_{CC} . The ratiometric change in the quiescent voltage output is defined as:

$$V_{\text{RatERRQVO}} = \left[\left(V_{\text{IOUTQ}}(5\text{V}) \times \frac{V_{\text{CC}}}{5 \text{ V}} \right) - V_{\text{IOUTQ}}(V_{\text{CC}}) \right] \times 1000 (\text{mV})$$

and the ratiometric change (%) in sensitivity is defined as:

$$\text{Rat}_{\text{ERRSens}} = \left[1 - \frac{\left(\frac{\text{Sens}(V_{\text{CC}})}{\text{Sens}(5\text{V})} \right)}{\left(\frac{V_{\text{CC}}}{5 \text{ V}} \right)} \right] \times 100 (\%)$$

and the ratiometric change (%) in clamp voltage is defined as:

$$\text{Rat}_{\text{ERRCLP}} = \left[1 - \frac{\left(\frac{V_{\text{CLP}}(V_{\text{CC}})}{V_{\text{CLP}}(5\text{V})} \right)}{\left(\frac{V_{\text{CC}}}{5 \text{ V}} \right)} \right] \times 100 (\%)$$

ZERO CURRENT OUTPUT VOLTAGE ($V_{IOUT(Q)}$)

The output of the sensor when the primary current is zero. For a unipolar supply voltage, it nominally remains at $0.5 \times V_{CC}$ for a bidirectional device and $0.1 \times V_{CC}$ for a unidirectional device. For example, in the case of a bidirectional output device, $V_{CC} = 5\text{ V}$ translates into $V_{IOUT(Q)} = 2.5\text{ V}$. Variation in $V_{IOUT(Q)}$ can be attributed to the resolution of the Allegro linear IC quiescent voltage trim and thermal drift.

ELECTRICAL OFFSET ERROR (V_{OE})

The deviation of the device output from its ideal quiescent value of $0.5 \times V_{CC}$ due to nonmagnetic causes. To convert this voltage to amperes, divide by the device sensitivity, Sens.

TOTAL OUTPUT ERROR (E_{TOT})

The difference between the current measurement from the sensor IC and the actual current (I_P), relative to the actual current. This is equivalent to the difference between the ideal output voltage and the actual output voltage, divided by the ideal sensitivity, relative to the current flowing through the primary conduction path:

$$E_{TOT(IP)} = \frac{V_{IOUT(IP)} - V_{IOUT_{IDEAL}(IP)}}{Sens_{IDEAL} \times I_{PRMAX}} \times 100 (\%)$$

$$V_{IOUT_{IDEAL}(IP)} = V_{IOUT_{IDEAL}(Q)} + (Sens_{IDEAL} \times I_P)$$

The Total Output Error incorporates all sources of error and is a function of I_P .

At relatively high currents, E_{TOT} will be mostly due to sensitivity error, and at relatively low currents, E_{TOT} will be mostly due to Offset Voltage (V_{OE}). In fact, as I_P approaches zero, E_{TOT} approaches infinity due to the offset voltage. This is illustrated in Figure 1 and Figure 2. Figure 1 shows a distribution of output voltages versus I_P at 25°C and across temperature. Figure 2 shows the corresponding E_{TOT} versus I_P .

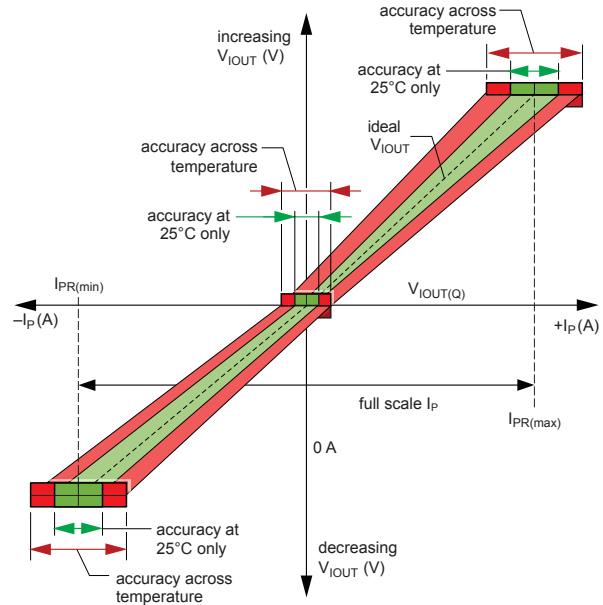

Figure 1: Output Voltage versus Sensed Current

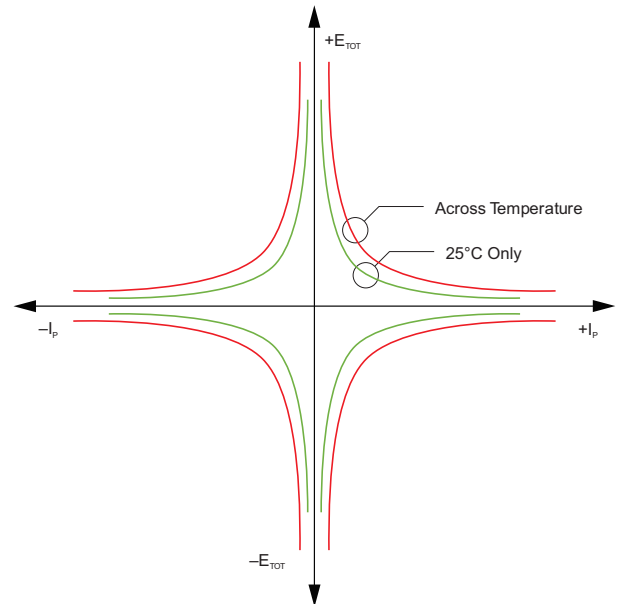

Figure 2: Total Output Error versus Sensed Current

Definitions of Dynamic Response Characteristics

POWER-ON TIME (t_{PO})

When the supply is ramped to its operating voltage, the device requires a finite time to power its internal components before responding to an input magnetic field.

Power-On Time, t_{PO} , is defined as the time it takes for the output voltage to settle within $\pm 10\%$ of its steady-state value under an applied magnetic field, after the power supply has reached its minimum specified operating voltage, $V_{CC}(\text{min.})$, as shown in the chart at right.

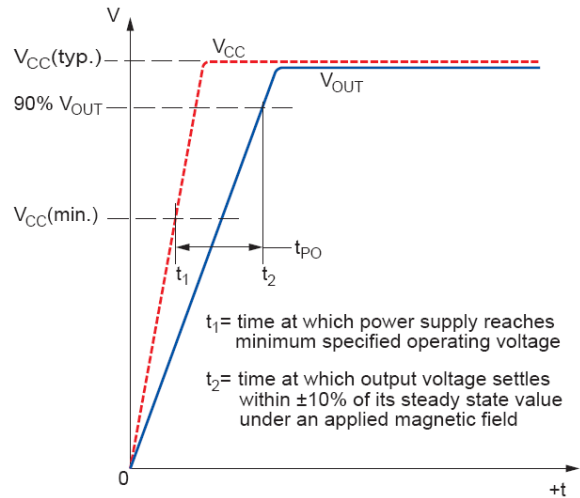

Figure 3: Power-On Time (t_{PO})

RISE TIME (t_r)

The time interval between a) when the sensor reaches 10% of its full-scale value, and b) when it reaches 90% of its full-scale value.

PROPAGATION DELAY (t_{pd})

The time interval between a) when the sensed current reaches 20% of its full-scale value, and b) when the sensor output reaches 20% of its full-scale value.

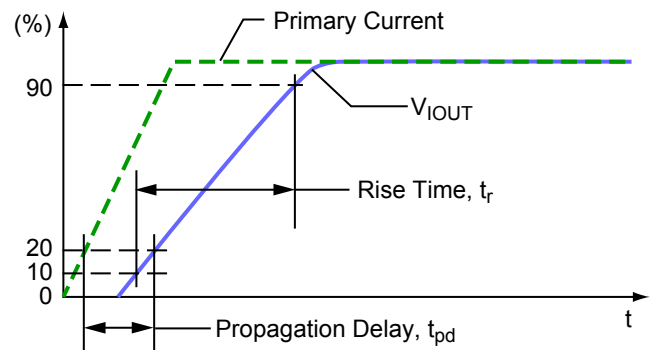

Figure 4: Propagation Delay (t_{PD}) and Rise Time (t_r)

RESPONSE TIME ($t_{RESPONSE}$)

The time interval between a) when the sensed current reaches 90% of its final value, and b) when the sensor output reaches 90% of its full-scale value.

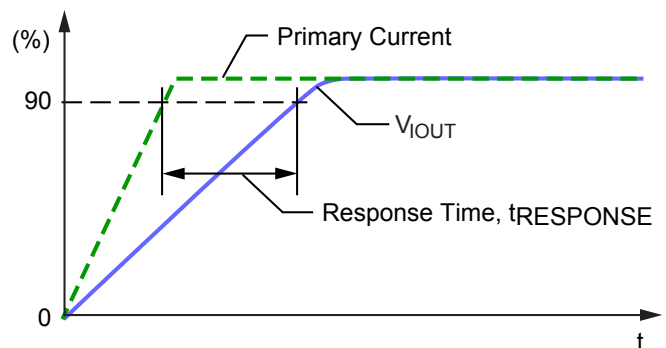

Figure 5: Response Time ($t_{RESPONSE}$)

FUNCTIONAL DESCRIPTION

Power-On Reset (POR) and Undervoltage Lock-Out (UVLO) Operation – Nominal Supply Voltage = 5 V

The descriptions in this section assume: temperature = 25°C, no output load (R_L, C_L), and no significant magnetic field is present.

- Power-Up.** At power-up, as V_{CC} ramps up, the output is in a high-impedance state. When V_{CC} crosses V_{PORH} (location [1] in Figure 6 and [1'] in Figure 7), the POR Release counter starts counting for t_{PORR} . At this point, if V_{CC} exceeds V_{UVLOD} [2'], the output will go to $V_{CC}/2$ after t_{UVLOD} [3'].

If V_{CC} does not exceed V_{UVLOD} [2], the output will stay in the high-impedance state until V_{CC} reaches V_{UVLOD} [3] and then will go to $V_{CC}/2$ after t_{UVLOD} [4].

- V_{CC} drops below $V_{CC(min)} = 4.5$ V.** If V_{CC} drops below V_{UVLOE} [4', 5], the UVLO Enable Counter starts counting. If V_{CC} is still below V_{UVLOE} when counter reaches t_{UVLOE} , the UVLO function will be enabled and the output will be pulled near GND [6]. If V_{CC} exceeds V_{UVLOE} before the UVLO Enable Counter reaches t_{UVLOE} [5'], the output will continue to be $V_{CC}/2$.

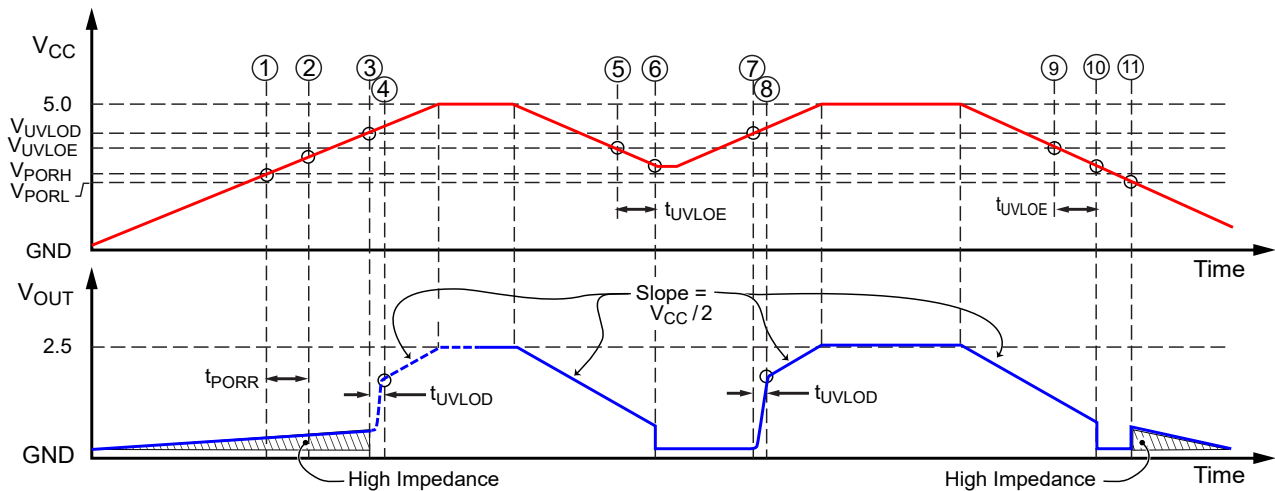

Figure 6: POR and UVLO Operation – Slow Rise Time Case

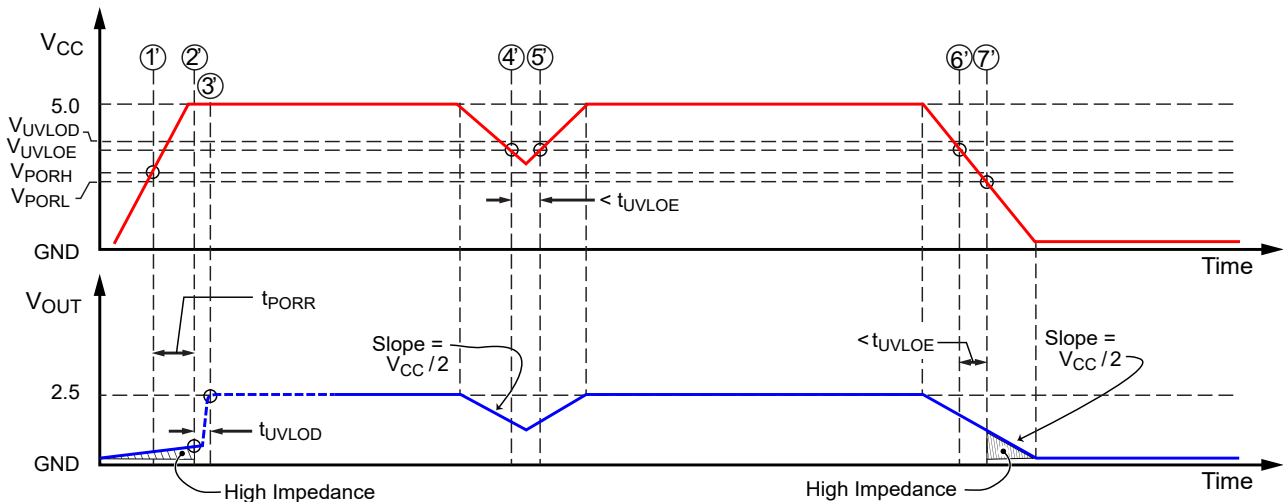

Figure 7: POR and UVLO Operation – Fast Rise Time Case

- **Coming out of UVLO.** While UVLO is enabled [6], if V_{CC} exceeds V_{UVLOD} [7], UVLO will be disabled after t_{UVLOD} , and the output will be $V_{CC}/2$ [8].
- **Power-Down.** As V_{CC} ramps down below V_{UVLOE} [6', 9], the UVLO Enable Counter will start counting. If V_{CC} is higher than V_{PORL} when the counter reaches t_{UVLOE} , the UVLO function will be enabled and the output will be pulled near GND [10]. The output will enter a high-impedance state as V_{CC} goes below V_{PORL} [11]. If V_{CC} falls below V_{PORL} before the UVLO Enable Counter reaches t_{UVLOE} , the output will transition directly into a high-impedance state [7'].

Power-On Reset (POR) Only – Nominal Supply Voltage = 3.3V

The descriptions in this section assume: temperature = 25°C, no output load (R_L , C_L), and $I_P = 0$ A.

Power-Up

At power-up, as V_{CC} ramps up, the output is in a high-impedance state. When V_{CC} crosses V_{PORH} (location [1] in Figure 8 and [1'] in Figure 9), the POR Release counter starts counting for t_{PO} [2, 2']. At this point, the output will go to $V_{CC}/2$.

V_{CC} drops below $V_{CC}(\min) = 3$ V

If V_{CC} drops below V_{PORH} [3'] but remains higher than V_{PORL} [4'], the output will continue to be $V_{CC}/2$.

Power-Down

As V_{CC} ramps down below V_{PORL} [3, 5'], the output will enter a high-impedance state.

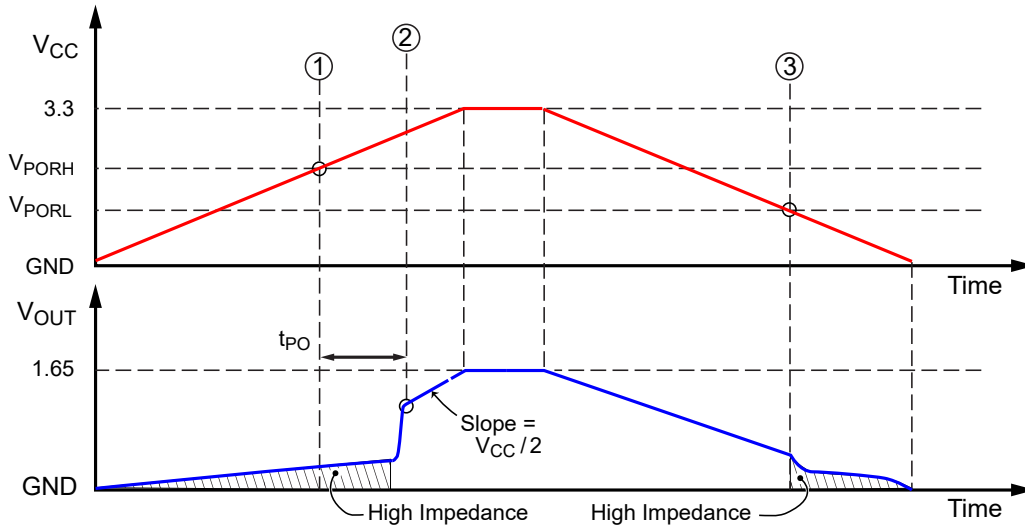

Figure 8: POR and UVLO Operation – Slow Rise Time Case

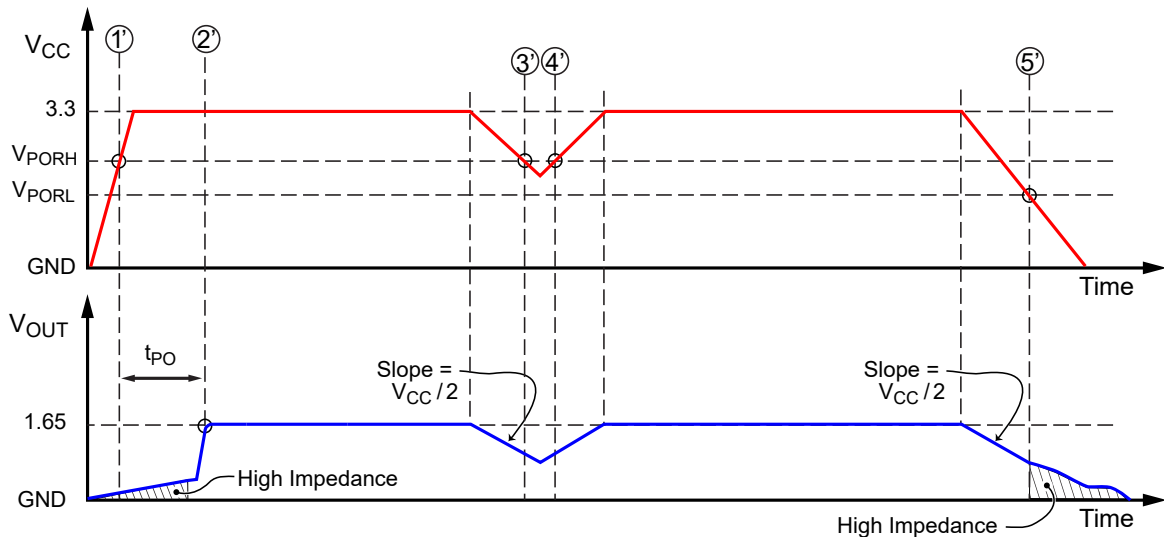

Figure 9: POR and UVLO Operation – Fast Rise Time Case

CHOPPER STABILIZATION TECHNIQUE

When using Hall-effect technology, a limiting factor for switchpoint accuracy is the small signal voltage developed across the Hall element. This voltage is disproportionately small relative to the offset that can be produced at the output of the Hall sensor IC. This makes it difficult to process the signal while maintaining an accurate, reliable output over the specified operating temperature and voltage ranges.

Chopper stabilization is a unique approach used to minimize Hall offset on the chip. Allegro employs a technique to remove key sources of the output drift induced by thermal and mechanical stresses. This offset reduction technique is based on a signal modulation-demodulation process. The undesired offset signal is separated from the magnetic field-induced signal in the frequency domain, through modulation. The subsequent demodulation acts as a modulation process for the offset, causing the magnetic-field-induced signal to recover its original spectrum at baseband, while the DC offset becomes a high-frequency signal. The magnetic-

sourced signal then can pass through a low-pass filter, while the modulated DC offset is suppressed.

In addition to the removal of the thermal and stress-related offset, this novel technique also reduces the amount of thermal noise in the Hall sensor IC while completely removing the modulated residue resulting from the chopper operation. The chopper stabilization technique uses a high-frequency sampling clock. For demodulation process, a sample-and-hold technique is used. This high-frequency operation allows a greater sampling rate, which results in higher accuracy and faster signal-processing capability. This approach desensitizes the chip to the effects of thermal and mechanical stresses, and produces devices that have extremely stable quiescent Hall output voltages and precise recoverability after temperature cycling. This technique is made possible through the use of a BiCMOS process, which allows the use of low-offset, low-noise amplifiers in combination with high-density logic integration and sample-and-hold circuits.

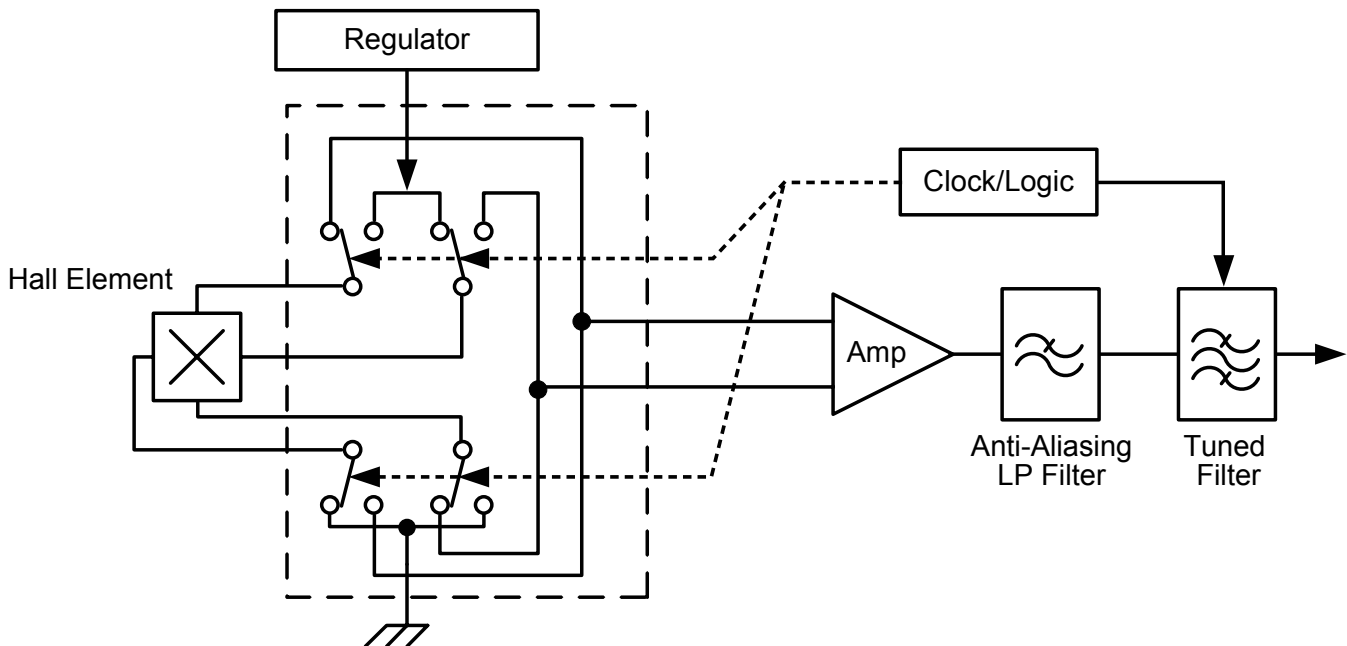

Figure 10: Concept of Chopper Stabilization Technique

APPLICATION INFORMATION

Field from Nearby Current Path

To best use the CMR capabilities of these devices, the circuit board containing the ICs should be designed to make the external magnetic fields on both Hall plates equal. This helps to minimize error due to external fields generated by the current-carrying PCB traces themselves. There are three main parameters for each current-carrying trace that determine the error that it will induce on an IC: *distance* from the IC, *width* of the current-carrying conductor, and the *angle* between it and the IC. Figure 11 shows an example of a current-carrying conductor routed near an IC. The distance between the device and the conductor, d , is the distance from the device center to the center of the conductor. The width of the current path is w . The angle between the device and the current path, θ , is defined as the angle between a straight line connecting the two Hall plates and a line perpendicular to the current path.

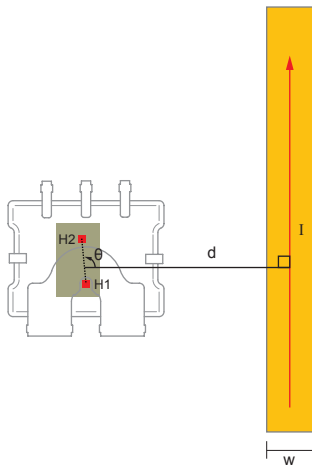

Figure 11: ACS72981 with nearby current path, viewed from the bottom of the sensor

When it is not possible to keep θ close to 90° , the next best option is to keep the distance from the current path to the current sensor IC, d , as large as possible. Assuming that the current path is at the worst-case angle in relation to the IC, $\theta = 0^\circ$ or 180° , the equation:

$$Error = \frac{2 \times I}{Cf} \times \left[\frac{1}{d - \frac{H_{space}}{2} \times \cos\theta} - \frac{1}{d + \frac{H_{space}}{2} \times \cos\theta} \right]$$

where H_{space} is the distance between the two Hall plates and Cf is the coupling factor of the IC. This coupling factor varies between the different ICs. The ACS72981 has a coupling factor of 5 to 5.5 G/A, whereas other Allegro ICs can range from 10 to 15 G/A. The ACS72981 H_{space} is 1.9 mm.

Other Layout Practices to Consider

When laying out a board that contains an Allegro current sensor IC with CMR, the direction and proximity of all current-carrying paths are important, but they are not the only factors to consider when optimizing IC performance. Other sources of stray fields that can contribute to system error include traces that connect to the IC's integrated current conductor, as well as the position of nearby permanent magnets.

The way that the circuit board connects to a current sensor IC must be planned with care. Common mistakes that can impact performance are:

- The angle of approach of the current path to the I_P pins
- Extending the current trace too far beneath the IC

THE ANGLE OF APPROACH

One common mistake when using an Allegro current sensor IC is to bring the current in from an undesirable angle. Figure 12 shows an example of the approach of the current traces to the IC (in this case, the ACS72981). In this figure, traces are shown for I_{P+} and I_{P-} . The light green region is the desired area of approach for the current trace going to I_{P+} . This region is from 0° to 85° . This rule applies likewise for the I_{P-} trace.

The limitation of this region is to prevent the current-carrying trace from contributing any stray field that can cause error on the IC output. When the current traces connected to I_P are outside this region, they must be treated as discussed above (Field from a Nearby Current Path).

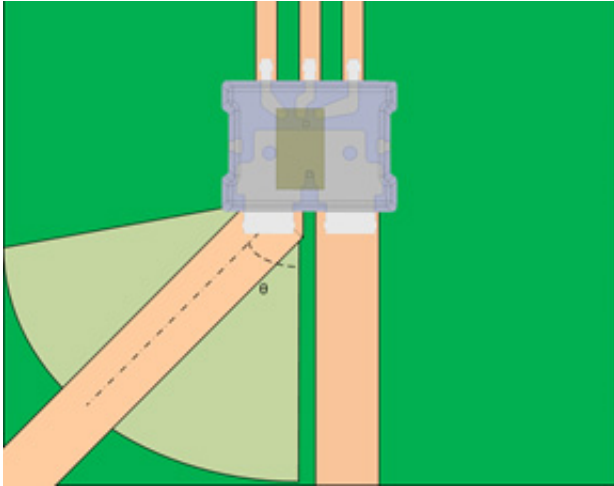

Figure 12: ACS72981 Current Trace Approach – the desired range of the angle θ is from 0° to 85°

ENCROACHMENT UNDER THE IC

In the LR package, the encroachment of the current-carrying trace under the device actually changes the path of the current flowing through the I_p bus. This can cause a change in the coupling factor of the I_p bus to the IC and can significantly reduce device performance. Using ANSYS Maxwell Electromagnetic Suites, the current density and magnetic field generated from the current flow were simulated. In Figure 13, there are results from two different simulations. The first is the case where the current trace leading up to the I_p bus terminates at the desired point. The second case is where the current trace encroaches far up the I_p bus. The red arrows in both simulations represent the areas of high current density. In the simulation with no excess overlap, the red areas, and hence the current density, are very different from the simulation with the excess overlap. It was also observed that the field on H1 was larger when there was no excess overlap. This can be observed by the darker shade of blue.

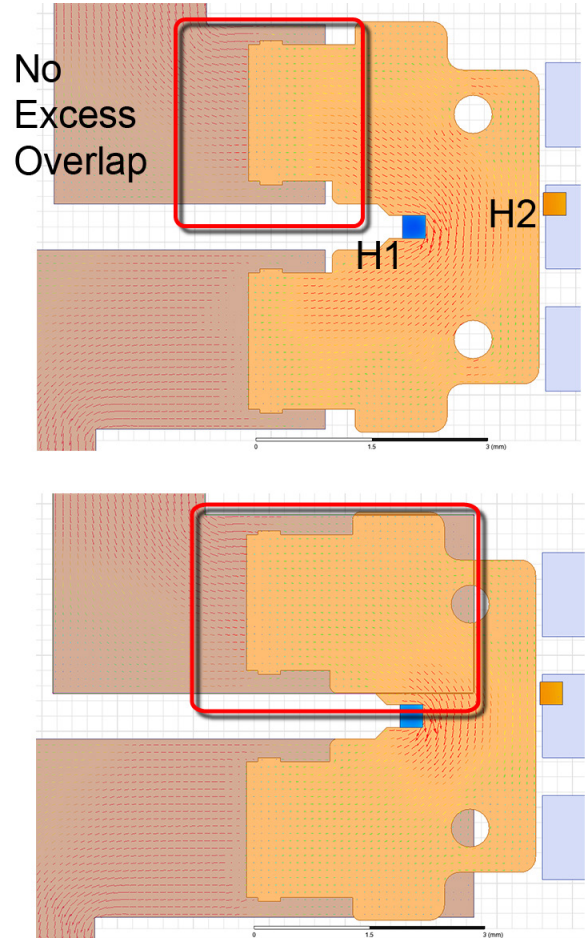

Figure 13: Simulations of ACS72981 Leadframe with Different Overlap of the Current Trace and the I_p Bus

Thermal Rise vs. Primary Current

Self-heating due to the flow of current should be considered during the design of any current sensing system. The sensor, printed circuit board (PCB), and contacts to the PCB will generate heat as current moves through the system.

The thermal response is highly dependent on PCB layout, copper thickness, cooling techniques, and the profile of the injected current. The current profile includes peak current, current “on-time”, and duty cycle. While the data presented in this section was collected with direct current (DC), these numbers may be used to approximate thermal response for both AC signals and current pulses.

The plot in Figure 14 shows the measured rise in steady-state die temperature of the ACS72981 versus continuous current at an ambient temperature, T_A , of 25°C. The thermal offset curves may be directly applied to other values of T_A . Conversely, Figure 15 shows the maximum continuous current at a given T_A . Surges beyond the maximum current listed in Figure 15 are allowed given the maximum junction temperature, $T_{J(MAX)}$ (165°C), is not exceeded.

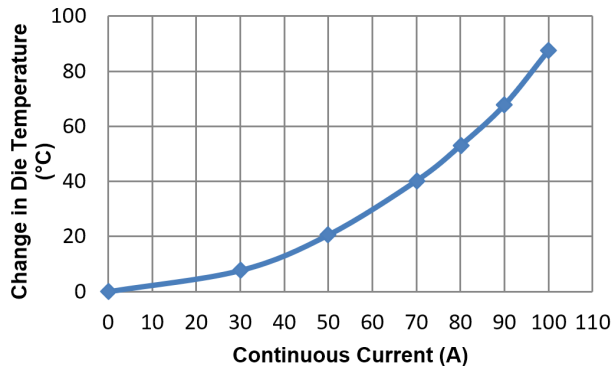

Figure 14: Self Heating in the LR Package Due to Current Flow

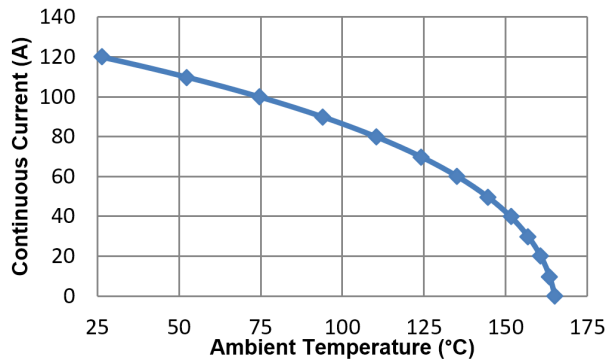

Figure 15: Maximum Continuous Current at a Given T_A

The thermal capacity of the ACS72981 should be verified by the end user in the application’s specific conditions. The maximum junction temperature, $T_{J(MAX)}$ (165°C), should not be exceeded. Further information on this application testing is available in the [DC Current Capability and Fuse Characteristics of Current Sensor ICs with 50 to 200 A Measurement Capability application note](#) on the Allegro website.

ASEK72981 Evaluation Board Layout

Thermal data shown in Figure 14 and Figure 15 was collected using the ASEK72981 Evaluation Board (TED-0002378). This board includes 1530 mm² of 2 oz. copper (0.0694 mm) connected to pins 5 and 6 with thermal vias connecting the 8 layers. The PCB is shown below in Figure 16.

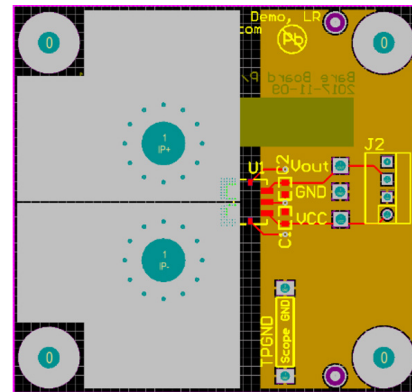

Figure 16: ASEK72981 Evaluation Board

Gerber files for the ASEK72981 evaluation board are available for download from the Allegro website. See the technical documents section of the [ACS72981 device webpage](#).

PACKAGE OUTLINE DRAWING

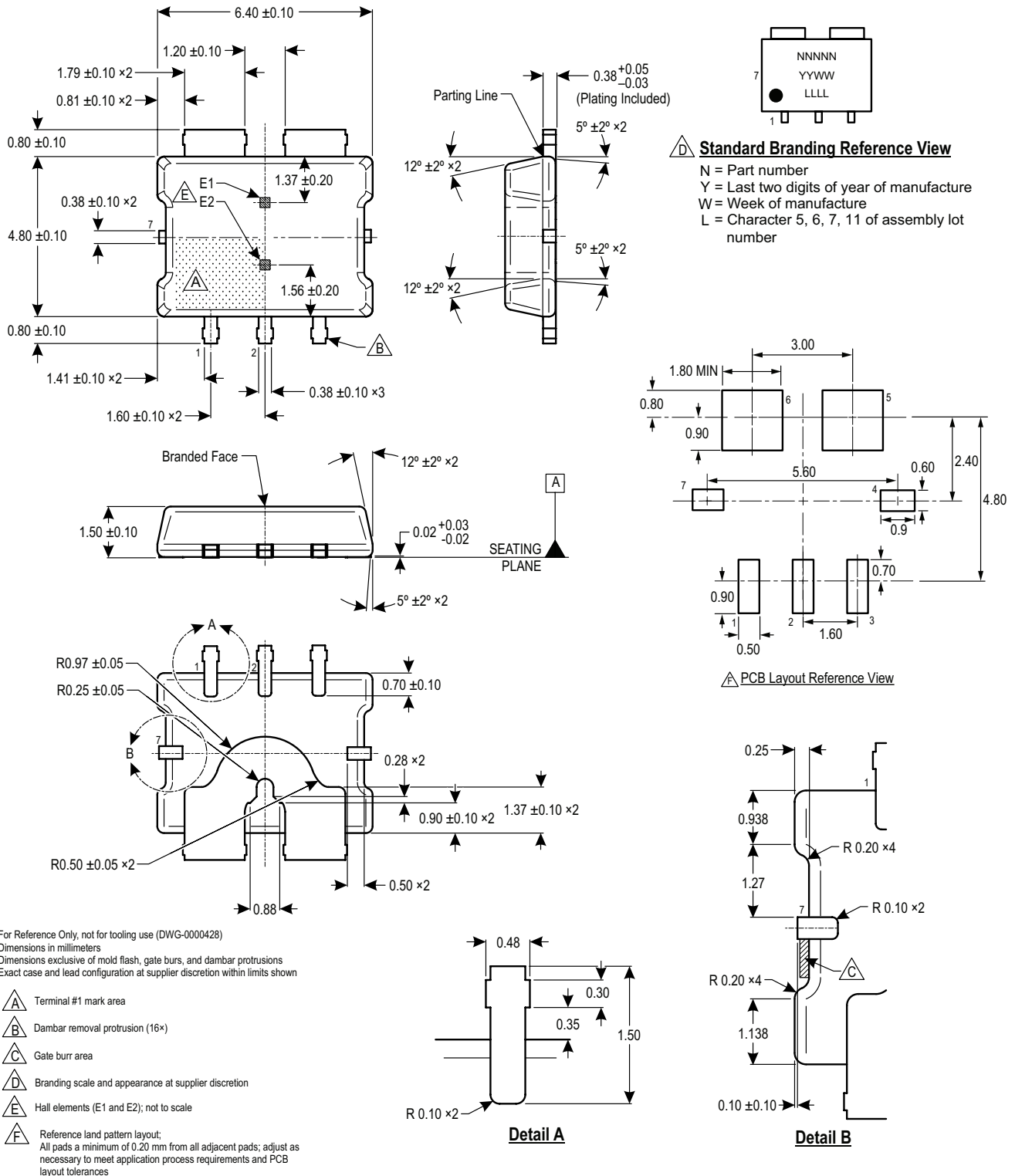

Figure 17: Package LR, 7-Pin PSOF Package

Revision History

Number	Date	Description
–	March 2, 2018	Initial release
1	September 24, 2018	Updated Features and Benefits (page 1); minor editorial updates
2	April 12, 2019	Updated product variants and added characteristic performance data plots (page 2, 6-17, 22-34).
3	May 31, 2019	Added -200U3, -200U5, -200B3, and -200B5 product variants (page 2, 18-21, 38-41)
4	July 17, 2019	Added Thermal Characteristics table (page 3)
5	August 28, 2019	Added Maximum Continuous Current to Absolute Maximum Ratings table (page 3), ESD ratings table (page 3), and updated thermal data section (pages 51-52)
6	November 8, 2019	Removed Zero Current Output Voltage from Operating Characteristics table (page 5). Added Zero Current-Output Voltage to Performance Characteristics tables (pages 6-21). Updated Characteristic Performance Typical Frequency Response plots (page 42). Updated Zero-Current Output Voltage definition (page 44).
7	November 21, 2019	Added Output Slew Rate characteristic (page 5); corrected ASEK72981 Evaluation Board Layout section (page 52)
8	December 6, 2019	Updated ACS72981LLRATR-050B5 Electrical Offset Error vs. Temperature plot (page 27)
9	September 24, 2020	Corrected Selection Guide sensitivity values for -200U3, -200U5, -200B3, and -200B5 product variants (page 2), and Performance Characteristics sensitivity value for -200U3 (page 18).
10	March 20, 2024	Added solder reflow footnote to Lifetime Accuracy Characteristics (pages 6-21); added Sensitivity equation to Sensitivity section (page 43); updated Total Output Error equation (page 44), and minor editorial updates.

Copyright 2024, Allegro MicroSystems.

Allegro MicroSystems reserves the right to make, from time to time, such departures from the detail specifications as may be required to permit improvements in the performance, reliability, or manufacturability of its products. Before placing an order, the user is cautioned to verify that the information being relied upon is current.

Allegro's products are not to be used in any devices or systems, including but not limited to life support devices or systems, in which a failure of Allegro's product can reasonably be expected to cause bodily harm.

The information included herein is believed to be accurate and reliable. However, Allegro MicroSystems assumes no responsibility for its use; nor for any infringement of patents or other rights of third parties which may result from its use.

Copies of this document are considered uncontrolled documents.

For the latest version of this document, visit our website:

www.allegromicro.com

Looking for pricing, stock, or lifecycle information?

Click below to explore more details on WIN SOURCE:

- ⊖ [View ACS72981KLRATR-150B5 on WIN SOURCE](#)
- ⊖ [Allegro MicroSystems, LLC Information](#)

Optimize Your Supply Chain with WIN SOURCE Solutions

- ✓ Global Sourcing Solution
- ✓ Obsolete Management
- ✓ Cost Control Management
- ✓ Shortage Management
- ✓ Alternative Solution
- ✓ Excess Inventory Management