



THE DATASHEET OF DPG30C300HB



HiPerFRED²

$$V_{RRM} = 300V$$

$$I_{FAV} = 2x \quad 15A$$

$$t_{rr} = 35ns$$

High Performance Fast Recovery Diode
 Low Loss and Soft Recovery
 Common Cathode

Part number

DPG30C300HB

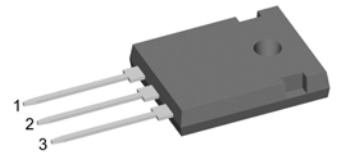

Backside: cathode

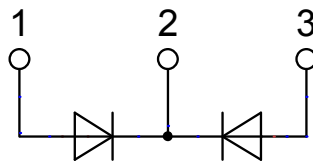
**Features / Advantages:**

- Planar passivated chips
- Very low leakage current
- Very short recovery time
- Improved thermal behaviour
- Very low I_{rm} -values
- Very soft recovery behaviour
- Avalanche voltage rated for reliable operation
- Soft reverse recovery for low EMI/RFI
- Low I_{rm} reduces:
 - Power dissipation within the diode
 - Turn-on loss in the commutating switch

Applications:

- Antiparallel diode for high frequency switching devices
- Antisaturation diode
- Snubber diode
- Free wheeling diode
- Rectifiers in switch mode power supplies (SMPS)
- Uninterruptible power supplies (UPS)

Package: TO-247

- Industry standard outline
- RoHS compliant
- Epoxy meets UL 94V-0

Fast Diode				Ratings		
Symbol	Definition	Conditions	min.	typ.	max.	Unit
V_{RSM}	max. non-repetitive reverse blocking voltage	$T_{VJ} = 25^{\circ}C$			300	V
V_{RRM}	max. repetitive reverse blocking voltage	$T_{VJ} = 25^{\circ}C$			300	V
I_R	reverse current, drain current	$V_R = 300 V$	$T_{VJ} = 25^{\circ}C$		1	μA
		$V_R = 300 V$	$T_{VJ} = 150^{\circ}C$		0.08	mA
V_F	forward voltage drop	$I_F = 15 A$	$T_{VJ} = 25^{\circ}C$		1.25	V
					1.50	V
		$I_F = 15 A$	$T_{VJ} = 150^{\circ}C$		1.00	V
					1.27	V
I_{FAV}	average forward current	$T_C = 145^{\circ}C$ rectangular $d = 0.5$	$T_{VJ} = 175^{\circ}C$		15	A
V_{FO}	threshold voltage	} for power loss calculation only	$T_{VJ} = 175^{\circ}C$		0.69	V
r_F	slope resistance				17.3	m Ω
R_{thJC}	thermal resistance junction to case				1.7	K/W
R_{thCH}	thermal resistance case to heatsink			0.25		K/W
P_{tot}	total power dissipation	$T_C = 25^{\circ}C$			90	W
I_{FSM}	max. forward surge current	$t = 10 \text{ ms}; (50 \text{ Hz}), \text{ sine}; V_R = 0 V$	$T_{VJ} = 45^{\circ}C$		240	A
C_J	junction capacitance	$V_R = 150 V \quad f = 1 \text{ MHz}$	$T_{VJ} = 25^{\circ}C$		20	pF
I_{RM}	max. reverse recovery current	} $I_F = 15 A; V_R = 200 V$	$T_{VJ} = 25^{\circ}C$		3	A
			$T_{VJ} = 125^{\circ}C$		6.5	A
t_{rr}	reverse recovery time	} $-di_F/dt = 200 A/\mu s$	$T_{VJ} = 25^{\circ}C$		35	ns
			$T_{VJ} = 125^{\circ}C$		55	ns

Package TO-247			Ratings			
Symbol	Definition	Conditions	min.	typ.	max.	Unit
I_{RMS}	RMS current	per terminal ¹⁾			50	A
T_{VJ}	virtual junction temperature		-55		175	°C
T_{op}	operation temperature		-55		150	°C
T_{stg}	storage temperature		-55		150	°C
Weight				6		g
M_D	mounting torque		0.8		1.2	Nm
F_C	mounting force with clip		20		120	N

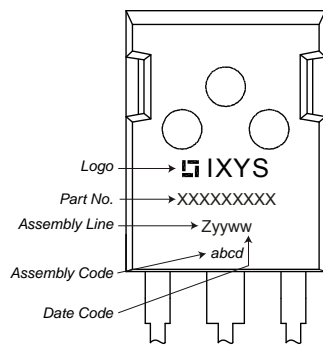
Product Marking

Part number

D = Diode
 P = HiPerFRED
 G = extreme fast
 30 = Current Rating [A]
 C = Common Cathode
 300 = Reverse Voltage [V]
 HB = TO-247AD (3)

Ordering	Part Number	Marking on Product	Delivery Mode	Quantity	Code No.
Standard	DPG30C300HB	DPG30C300HB	Tube	30	502567

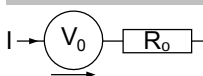
Similar Part	Package	Voltage class
DPG30C300PB	TO-220AB (3)	300
DPG30C300PC	TO-263AB (D2Pak) (2)	300

Equivalent Circuits for Simulation
** on die level*
 $T_{VJ} = 175\text{ °C}$

Fast Diode

$V_{0\ max}$	threshold voltage	0.69	V
$R_{0\ max}$	slope resistance *	14.7	mΩ

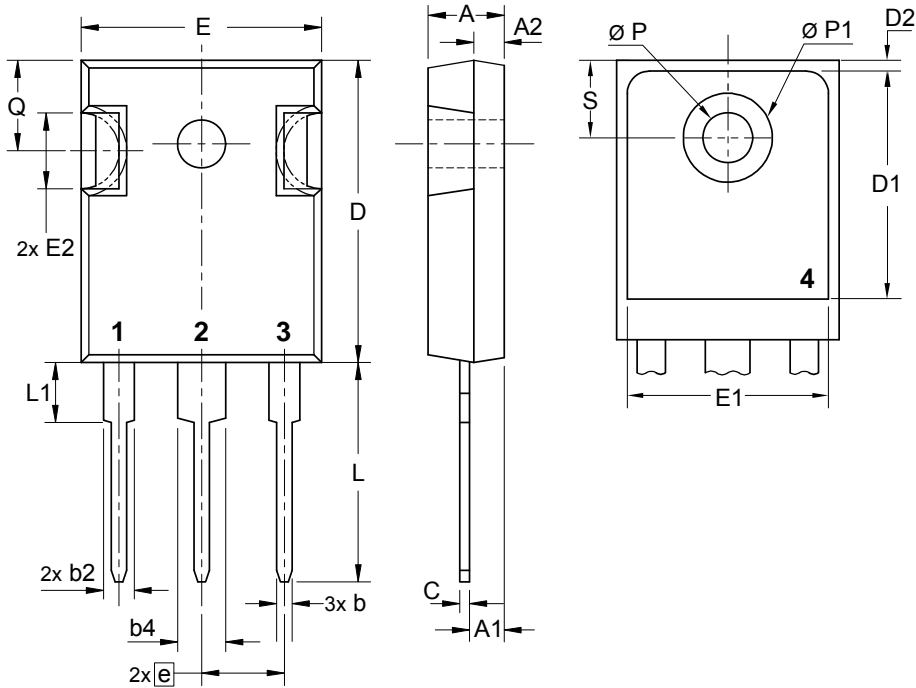
Outlines TO-247

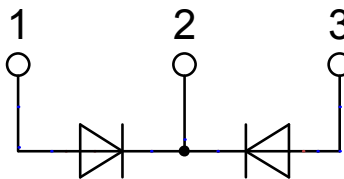

Sym.	Inches		Millimeter	
	min.	max.	min.	max.
A	0.185	0.209	4.70	5.30
A1	0.087	0.102	2.21	2.59
A2	0.059	0.098	1.50	2.49
D	0.819	0.845	20.79	21.45
E	0.610	0.640	15.48	16.24
E2	0.170	0.216	4.31	5.48
e	0.215 BSC		5.46 BSC	
L	0.780	0.800	19.80	20.30
L1	-	0.177	-	4.49
Ø P	0.140	0.144	3.55	3.65
Q	0.212	0.244	5.38	6.19
S	0.242 BSC		6.14 BSC	
b	0.039	0.055	0.99	1.40
b2	0.065	0.094	1.65	2.39
b4	0.102	0.135	2.59	3.43
c	0.015	0.035	0.38	0.89
D1	0.515	-	13.07	-
D2	0.020	0.053	0.51	1.35
E1	0.530	-	13.45	-
Ø P1	-	0.29	-	7.39



Fast Diode

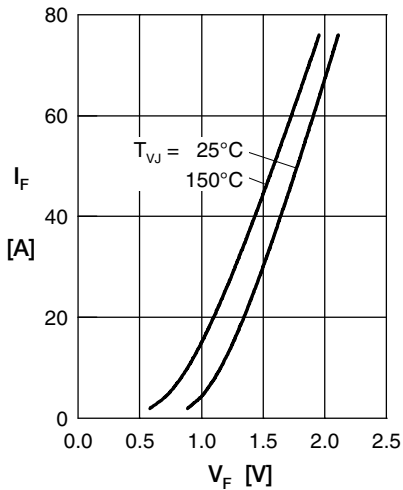

Fig. 1 Forward current I_F versus V_F

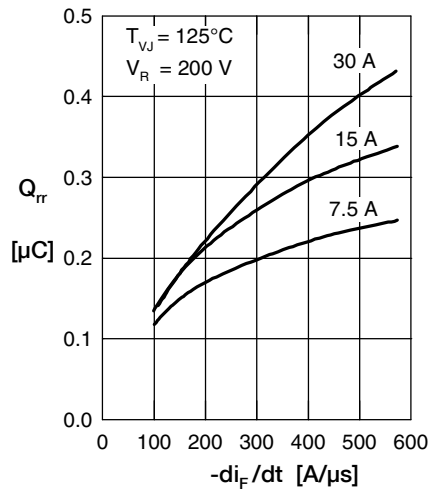

Fig. 2 Typ. reverse recov. charge Q_{rr} versus $-di_F/dt$

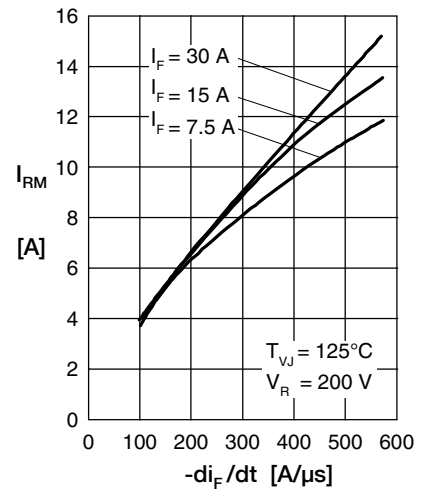

Fig. 3 Typ. peak reverse current I_{RM} versus $-di_F/dt$

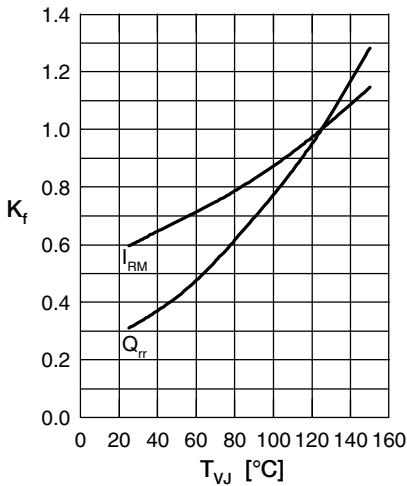

Fig. 4 Typ. dynamic parameters Q_{rr} , I_{RM} versus T_{VJ}

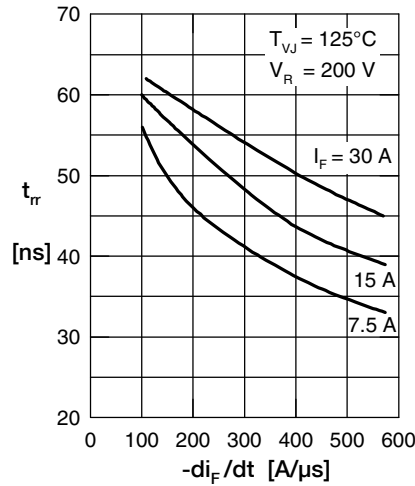

Fig. 5 Typ. recovery time t_{rr} versus $-di_F/dt$

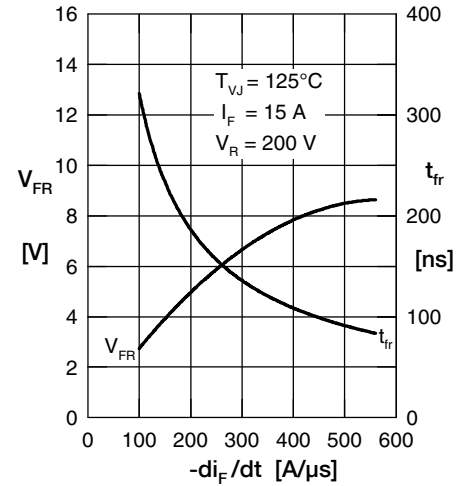

Fig. 6 Typ. peak forward voltage V_{FR} and t_{rr} versus di_F/dt

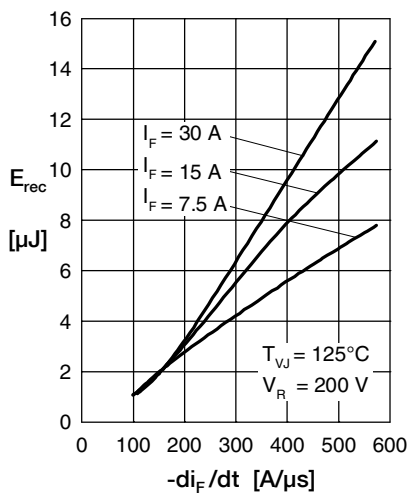

Fig. 7 Typ. recovery energy E_{rec} versus $-di_F/dt$

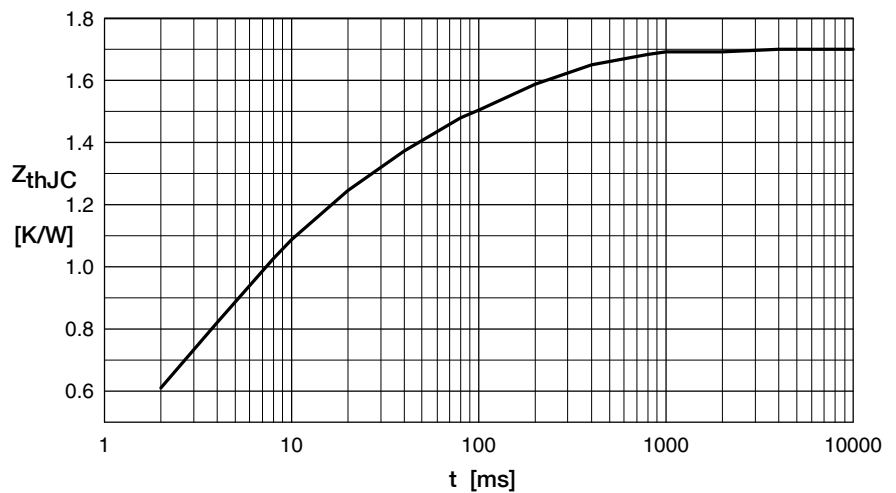



Fig. 8 Transient thermal resistance junction to case

Looking for pricing, stock, or lifecycle information?

Click below to explore more details on WIN SOURCE:

-  [View DPG30C300HB on WIN SOURCE](#)
-  [IXYS Information](#)

Optimize Your Supply Chain with WIN SOURCE Solutions

-  Global Sourcing Solution
-  Obsolete Management
-  Cost Control Management
-  Shortage Management
-  Alternative Solution
-  Excess Inventory Management