



THE DATASHEET OF UM3204QT



4-Bit Bidirectional Voltage-Level Translator for Open-Drain and Push-Pull Application

UM3204H CSP12 1.9×1.4

UM3204Q QFN14 3.5×3.5

UM3204QS QFN14 3.5×3.5

UM3204UE TSSOP14

UM3204QT QFN12 1.7×2.0

General Description

The UM3204 is quad channel ESD-protected level translator provide the level shifting necessary to allow data transfer in a multi-voltage system. Externally applied voltages, V_{CCB} and V_{CCA} , set the logic levels on either side of the device. A low-voltage logic signal present on the V_{CCA} side of the device appears as a high-voltage logic signal on the V_{CCB} side of the device, and vice-versa. The UM3204 bidirectional level translator utilizes a transmission-gate based design to allow data translation in either direction ($V_{CCA} \leftrightarrow V_{CCB}$) on any single data line. The UM3204 accepts V_{CCA} from +1.65V to +3.6V and V_{CCB} from +2.3V to +5.5V, making it ideal for data transfer between low-voltage ASICs / PLDs and higher voltage systems.

The UM3204 enters a three-state output mode to reduce supply current when output enable (OE) is low. The UM3204 is designed so that the OE input circuit is supplied by V_{CCA} . $\pm 5\text{kV}$ ESD protection on the V_{CCB} side for greater protection in applications that route signals externally. The UM3204 is a quad level translator available in CSP12 1.9×1.4, QFN14 3.5×3.5, TSSOP14 and QFN12 1.7×2.0 packages.

Applications

- SPI, MICROWIRE, and I²C Level Translation
- Low-Voltage ASIC Level Translation
- Smart Card Readers
- Cell-Phone Cradles
- Portable POS Systems
- Portable Communication Devices
- Low-Cost Serial Interfaces
- Cell-Phones
- GPS
- Telecommunications Equipment

Features

- Max Data Rates:
24Mbps(Push Pull),
2Mbps(Open Drain)
- Bidirectional Level Translation
- 1.65V to 3.6V on A Port and 2.3V to 5.5V on B Port($V_{CCA} \leq V_{CCB}$)
- $\pm 5\text{kV}$ ESD Protection on B Port
- No Power-Supply Sequencing Required
 V_{CCA} or V_{CCB} Can Be Ramped First
- CSP12, QFN14, TSSOP14 and QFN12 Packages

Pin Configurations

Top View

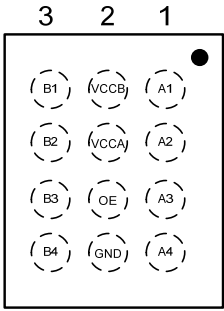
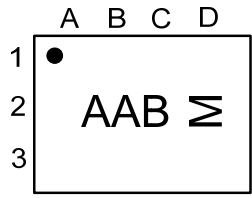
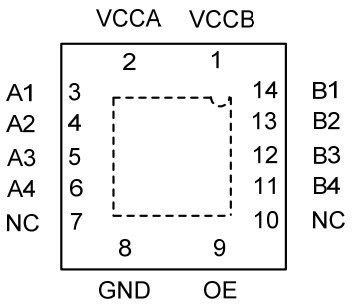
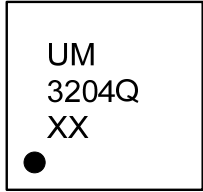
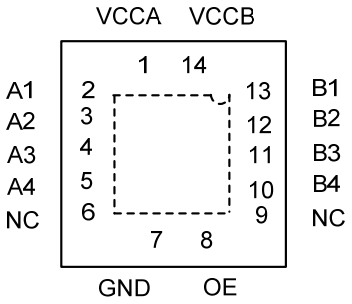
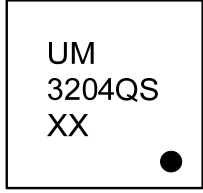
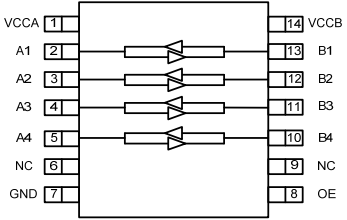
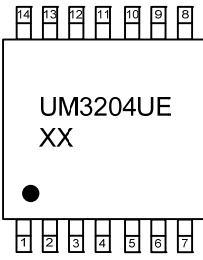
<p style="text-align: center;">(Top View)</p> 	 <p style="text-align: center;">M: Month Code UM3204H CSP12 1.9×1.4</p>
<p style="text-align: center;">(Top View)</p> 	 <p style="text-align: center;">XX: Week Code UM3204Q QFN14 3.5×3.5</p>
<p style="text-align: center;">(Top View)</p> 	 <p style="text-align: center;">XX: Week Code UM3204QS QFN14 3.5×3.5</p>
<p style="text-align: center;">(Top View)</p> 	 <p style="text-align: center;">XX: Week Code UM3204UE TSSOP14</p>

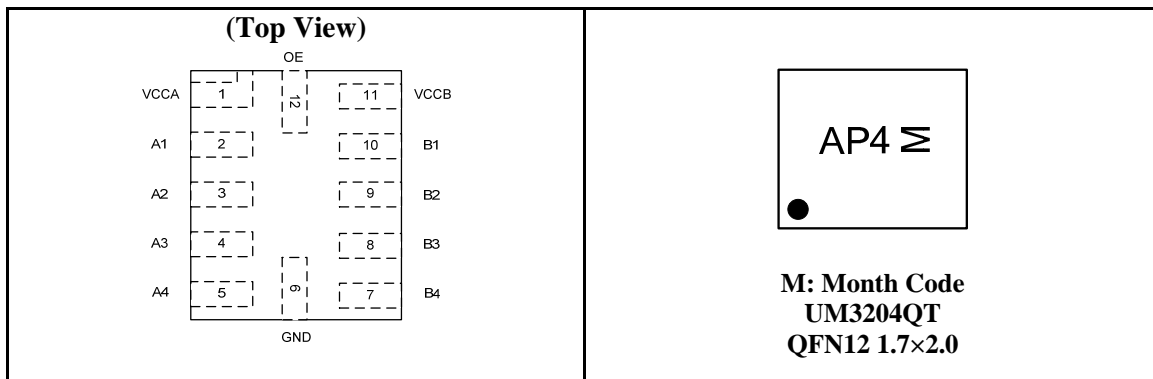

Ball Mapping for UM3204H

	A	B	C	D
1	A1	A2	A3	A4
2	V _{CCB}	V _{CCA}	OE	GND
3	B1	B2	B3	B4

Transparent Top View

Pin Description

Pin Name	Function
V _{CCA}	A-Port supply voltage. $1.65V \leq V_{CCA} \leq 3.6V$ and $V_{CCA} \leq V_{CCB}$
A1	Input/Output 1. Referenced to V _{CCA}
A2	Input/Output 2. Referenced to V _{CCA}
A3	Input/Output 3. Referenced to V _{CCA}
A4	Input/Output 4. Referenced to V _{CCA}
GND	Ground
OE	3-state output enable. Pull OE low to place all outputs in 3-state mode. Referenced to V _{CCA}
B4	Input/Output 4. Referenced to V _{CCB}
B3	Input/Output 3. Referenced to V _{CCB}
B2	Input/Output 2. Referenced to V _{CCB}
B1	Input/Output 1. Referenced to V _{CCB}
V _{CCB}	B-Port supply voltage. $2.3V \leq V_{CCB} \leq 5.5V$

Ordering Information

Part Number	Packaging Type	Marking Code	Shipping Qty
UM3204H	CSP12 1.9×1.4	AAB	3000pcs/7Inch Tape & Reel
UM3204Q	QFN14 3.5×3.5	UM3204Q	3000pcs/13Inch Tape & Reel
UM3204QS	QFN14 3.5×3.5	UM3204QS	3000pcs/13Inch Tape & Reel
UM3204UE	TSSOP14	UM3204UE	3000pcs/13Inch Tape & Reel
UM3204QT	QFN12 1.7×2.0	AP4	3000pcs/7Inch Tape & Reel

Absolute Maximum Ratings (Note 1)

Over operating free-air temperature range (unless otherwise noted)

Symbol	Parameter	Value	Unit
V_{CCA}	Supply Voltage Range	-0.5 to +4.5	V
V_{CCB}	Supply Voltage Range	-0.5 to +6.5	V
V_I	Input Voltage Range	A ports	-0.5 to +4.5
		B ports	-0.5 to +6.5
V_O	Voltage Range applied to any output in the high-impedance or power-off state	A ports	-0.5 to +4.5
		B ports	-0.5 to +6.5
V_O	Voltage Range applied to any output in the high or low state (Note 2)	A ports	-0.5 to ($V_{CCA}+0.5$)
		B ports	-0.5 to ($V_{CCB}+0.5$)
I_{IK}	Input Clamp Current	$V_I < 0$	-50 mA
I_{OK}	Output Clamp Current	$V_O < 0$	-50 mA
I_O	Continuous Output Current		±50 mA
	Continuous Current through V_{CCA} , V_{CCB} , or GND		±100 mA
T_{OP}	Operating Temperature Range		-40 to +85 °C
T_{STG}	Storage Temperature Range		-65 to +150 °C

Note1. Stresses beyond those listed under "absolute maximum ratings" may cause permanent damage to the device. These are stress ratings only and functional operation of the device at these or any other conditions beyond those indicated under "recommended operating conditions" is not implied. Exposure to absolute-maximum-rated conditions for extended periods may affect device reliability.

Note2. The value of V_{CCA} and V_{CCB} are provided in the recommended operating conditions table.

Recommended Operating Conditions (Note 1, 2)

Symbol	Parameter		V _{CCA}	V _{CCB}	Min	Max	Unit
V _{CCA}	Supply Voltage				1.65	3.6	V
V _{CCB}					2.3	5.5	
V _{IH}	High Level Input Voltage	A- Port	1.65V to 1.95V 2.3V to 3.6V	2.3V to 5.5V	V _{CCI} -0.2	V _{CCI}	V
		B- Port	1.65V to 3.6V		2.3V to 5.5V	V _{CCI} -0.4	
		OE					V _{CCA} ×0.65
V _{IL}	Low Level Input Voltage	A- Port	1.65V to 3.6V	2.3V to 5.5V	0	0.15	V
		B- Port			0	0.15	
		OE			0	V _{CCA} ×0.35	
Δt/ΔV	Input Transition Rise or Fall Time	A-Port push-pull driving	1.65V to 3.6V	2.3V to 5.5V		10	ns/V
		B-Port push-pull driving				10	
		Control input				10	

Note1. V_{CCI} is the supply voltage associated with the input port.

Note2. V_{CCA} must be less than or equal to V_{CCB} and must not exceed 3.6 V.

Electrical Characteristics (Note 1, 2, 3)

Over recommended operating free-air temperature range (unless otherwise noted)

Parameter	Test Conditions	V _{CCA}	V _{CCB}	T _A =25°C		-40°C to 85°C		Unit
				Typ	Max	Min	Max	
V _{OHA}	I _{OH} =-20μA	1.65V to 3.6V	2.3V to 5.5V			V _{CCA} ×0.8		V
V _{OLA}	I _{OL} =1mA	1.65V to 3.6V	2.3V to 5.5V				0.4	V
V _{OHB}	I _{OH} =-20μA	1.65V to 3.6V	2.3V to 5.5V			V _{CCB} ×0.8		V
V _{OLB}	I _{OL} =1mA	1.65V to 3.6V	2.3V to 5.5V				0.4	V
I _I	OE	V _I =V _{CCI} or GND	1.65V to 3.6V	2.3V to 5.5V	±1		±2	μA
I _{OZ}	A or B Port	OE=V _{IL}	1.65V to 3.6V	2.3V to 5.5V	±1		±2	μA
I _{CCA}	V _I =V _O =open, I _O =0	1.65V to V _{CCB}	2.3V to 5.5V				2.4	μA
		3.6V	0V				2.2	
		0V	5.5V				-1	
I _{CCB}	V _I =V _O =open, I _O =0	1.65V to V _{CCB}	2.3V to 5.5V				12	μA
		3.6V	0V				-1	
		0V	5.5V				1	
I _{CCA} + I _{CCB}	V _I =V _O =open, I _O =0	1.65V to 3.6V	2.3V to 5.5V				14.4	μA
C _i	OE		3.3V	3.3V	2.5		3.5	pF
C _{IO}	A Port		3.3V	3.3V	5		6.5	pF
	B Port				12		16.5	

Note1. V_{CCI} is the supply voltage associated with the input port.

Note2. V_{CCO} is the supply voltage associated with the output port.

Note3. V_{CCA} must be less than or equal to V_{CCB} and must not exceed 3.6 V.

Timing Requirements

Over recommended operating free-air temperature range, $V_{CCA} = 1.8V \pm 0.15V$ (unless otherwise noted)

			$V_{CCB}=2.5V \pm 0.2V$		$V_{CCB}=3.3V \pm 0.3V$		$V_{CCB}=5V \pm 0.5V$		Unit
			Min	Max	Min	Max	Min	Max	
Data Rate	Push-pull driving		24		24		24		Mbps
	Open-drain driving		2		2		2		
t_w Pulse duration	Push-pull driving	Data inputs	41		41		41		ns
	Open-drain driving		500		500		500		

Timing Requirements

Over recommended operating free-air temperature range, $V_{CCA} = 2.5V \pm 0.2V$ (unless otherwise noted)

			$V_{CCB}=2.5V \pm 0.2V$		$V_{CCB}=3.3V \pm 0.3V$		$V_{CCB}=5V \pm 0.5V$		Unit
			Min	Max	Min	Max	Min	Max	
Data Rate	Push-pull driving		24		24		24		Mbps
	Open-drain driving		2		2		2		
t_w Pulse duration	Push-pull driving	Data inputs	41		41		41		ns
	Open-drain driving		500		500		500		

Timing Requirements

Over recommended operating free-air temperature range, $V_{CCA} = 3.3V \pm 0.3V$ (unless otherwise noted)

			$V_{CCB}=3.3V \pm 0.3V$		$V_{CCB}=5V \pm 0.5V$		Unit
			Min	Max	Min	Max	
Data Rate	Push-pull driving		24		24		Mbps
	Open-drain driving		2		2		
t_w Pulse duration	Push-pull driving	Data inputs	41		41		ns
	Open-drain driving		500		500		

Switching Characteristics

Over recommended operating free-air temperature range, $V_{CCA} = 1.8V \pm 0.15V$ (unless otherwise noted)

Parameter	From (Input)	To (Output)	Test Conditions	$V_{CCB}=2.5V \pm 0.2V$		$V_{CCB}=3.3V \pm 0.3V$		$V_{CCB}=5V \pm 0.5V$		Unit
				Min	Max	Min	Max	Min	Max	
t_{PHL}	A	B	Push-pull		4.6		4.7		5.8	ns
			Open-drain	2.9	8.8	2.9	9.6	3	10	
t_{PLH}			Push-pull		6.8		6.8		7	
			Open-drain	45	260	36	208	27	198	
t_{PHL}	B	A	Push-pull		4.4		4.5		4.7	ns
			Open-drain	1.9	5.3	1.1	4.4	1.2	4	
t_{PLH}			Push-pull		5.3		4.5		0.5	
			Open-drain	45	175	36	140	27	102	
t_{dis}	OE	A		200		200		200	ns	
		B		200		200		200		
t_{en}	OE	A		50		40		35	ns	
		B		50		40		35		
t_{rA}	A port rise time		Push-pull	3.2	9.5	2.3	9.3	2	7.6	ns
			Open-drain	38	165	30	132	22	95	
t_{rB}	B port rise time		Push-pull	4	10.8	2.7	9.1	2.7	7.6	ns
			Open-drain	34	145	23	106	10	58	
t_{fA}	A port fall time		Push-pull	2	5.9	1.9	6	1.7	3.3	ns
			Open-drain	4.4	6.9	4.3	6.4	4.2	6.1	
t_{fB}	B port fall time		Push-pull	2.9	7.6	2.8	7.5	2.8	8.8	ns
			Open-drain	6.9	13.8	7.5	16.2	7	16.2	
$t_{SK(O)}$	Channel-to-channel			1		1		1	ns	
Max data rate			Push-pull		24		24		24	Mbps
			Open-drain		2		2		2	

Switching Characteristics

Over recommended operating free-air temperature range, $V_{CCA} = 2.5V \pm 0.2V$ (unless otherwise noted)

Parameter	From (Input)	To (Output)	Test Conditions	$V_{CCB}=2.5V \pm 0.2V$		$V_{CCB}=3.3V \pm 0.3V$		$V_{CCB}=5V \pm 0.5V$		Unit
				Min	Max	Min	Max	Min	Max	
t_{PHL}	A	B	Push-pull		3.2		3.3		3.4	ns
			Open-drain	1.7	6.3	2	6	2.1	5.8	
t_{PLH}			Push-pull		3.5		4.1		4.4	
			Open-drain	43	250	36	206	27	190	
t_{PHL}	B	A	Push-pull		3		3.6		4.3	ns
			Open-drain	1.8	4.7	2.6	4.2	1.2	4	
t_{PLH}			Push-pull		2.5		1.6		0.7	
			Open-drain	44	170	37	140	27	103	
t_{dis}	OE	A		200		200		200	ns	
		B		200		200		200		
t_{en}	OE	A		50		40		35	ns	
		B		50		40		35		
t_{rA}	A port rise time		Push-pull	2.8	7.4	2.6	6.6	1.8	5.6	ns
			Open-drain	34	149	28	121	24	89	
t_{rB}	B port rise time		Push-pull	3.2	8.3	2.9	7.2	2.4	6.1	ns
			Open-drain	35	151	24	112	12	64	
t_{fA}	A port fall time		Push-pull	1.9	5.7	1.9	5.5	1.8	5.3	ns
			Open-drain	4.4	6.9	4.3	6.2	4.2	5.8	
t_{fB}	B port fall time		Push-pull	2.2	7.8	2.4	6.7	2.6	6.6	ns
			Open-drain	5.1	8.8	5.4	9.4	5.4	10.4	
$t_{SK(O)}$	Channel-to-channel			1		1		1	ns	
Max data rate			Push-pull	24		24		24	Mbps	
			Open-drain	2		2		2		

Switching Characteristics

Over recommended operating free-air temperature range, $V_{CCA} = 3.3V \pm 0.3V$ (unless otherwise noted)

Parameter	From (Input)	To (Output)	Test Conditions	$V_{CCB}=3.3V \pm 0.3V$		$V_{CCB}=5V \pm 0.5V$		Unit
				Min	Max	Min	Max	
t_{PHL}	A	B	Push-pull		2.4		3.1	ns
			Open-drain	1.2	4.2	1.4	4.6	
t_{PLH}			Push-pull		4.2		4.4	
Open-drain			36	204	28	165		
t_{PHL}	B	A	Push-pull		2.5		3.3	ns
			Open-drain	1	124	1	97	
t_{PLH}			Push-pull		2.5		2.6	
Open-drain			3	139	3	105		
t_{dis}	OE	A		200		200	ns	
		B		200		200		
t_{en}	OE	A		40		35	ns	
		B		40		35		
t_{rA}	A port rise time		Push-pull	2.3	5.6	1.9	4.8	ns
			Open-drain	25	116	19	85	
t_{rB}	B port rise time		Push-pull	2.5	6.4	2.1	7.4	ns
			Open-drain	26	116	14	72	
t_{fA}	A port fall time		Push-pull	2	5.4	1.9	5	ns
			Open-drain	4.3	6.1	4.2	5.7	
t_{fB}	B port fall time		Push-pull	2.3	7.4	2.4	7.6	ns
			Open-drain	5	7.6	4.8	8.3	
$t_{SK(O)}$	Channel-to-channel			1		1	ns	
Max data rate			Push-pull	24		24	Mbps	
			Open-drain	2		2		

Applications Information

The UM3204 can be used in level-translation applications for interfacing devices or systems operating at different interface voltages with one another. The UM3204 is ideal for use in application where an open-drain driver is connected to the data I/Os. The UM3204 can also be used in applications where a push-pull driver is connected to the data I/Os, but the UM3304 might be a better option for such push-pull applications.

Block Diagram

The UM3204 (block diagram see Figure 1) does not require a direction-control signal to control the direction of data flow from A to B or from B to A. Each A-port I/O has an internal 10-k Ω pull-up resistor to V_{CCA} , and each B-port I/O has an internal 10-k Ω pull-up resistor to V_{CCB} . During a rising edge, the one-shot turns on the PMOS transistors (PU1, PU2) for a short duration, which speed up the low-to-high transition.

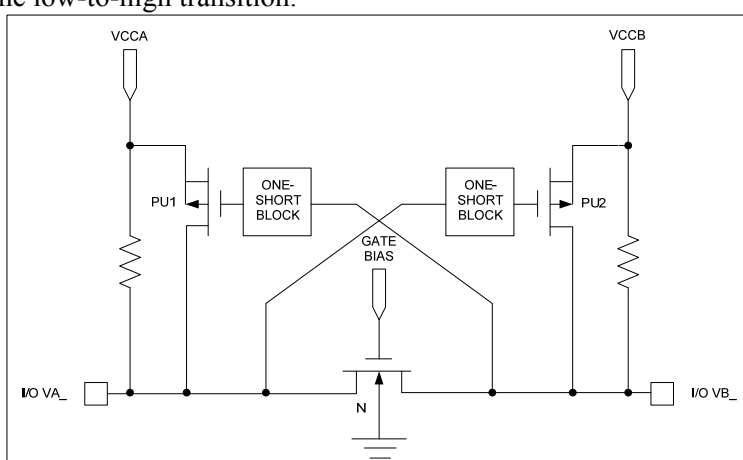

Figure 1 Block Diagram of UM3204 I/O Cell

Input Driver Requirements

The fall time (t_{fA} , t_{fB}) of a signal depends on the output impedance of the external device driving the data I/Os of the UM3204. Similarly, the t_{pHL} and the maximum data rates also depend on the output impedance of the external driver. The values for t_{fA} , t_{fB} , t_{pHL} , and the maximum data rates in the data sheet assume that the output impedance of the external driver is less than 50 Ω .

Power Up

During operation, ensure that $V_{CCA} \leq V_{CCB}$ at all times. During power-up sequencing, $V_{CCA} \geq V_{CCB}$ does not damage the device, so any power supply can be ramped up first. The UM3204 has circuitry that disables all output ports when either V_{CC} is switched off ($V_{CCA/B} = 0V$).

Enable and Disable

The UM3204 has an OE input that is used to disable the device by setting OE = low, which places all I/Os in the high-impedance (Hi-Z) state. The disable time (t_{dis}) indicates the delay between the time when OE goes low and when the outputs actually get disabled (Hi-Z). The enable time (t_{en}) indicates the amount of time the user must allow for the one-shot circuitry to become operational after OE is taken high.

Pull-up or Pull-down Resistors on I/O Lines

Each A-port I/O has an internal 10-kΩ pull-up resistor to V_{CCA} , and each B-port I/O has an internal 10-kΩ pull-up resistor to V_{CCB} . If a smaller value of pull-up resistor is required, an external resistor must be added from the I/O to V_{CCA} or V_{CCB} (in parallel with the internal 10-kΩ resistor).

Test Circuits

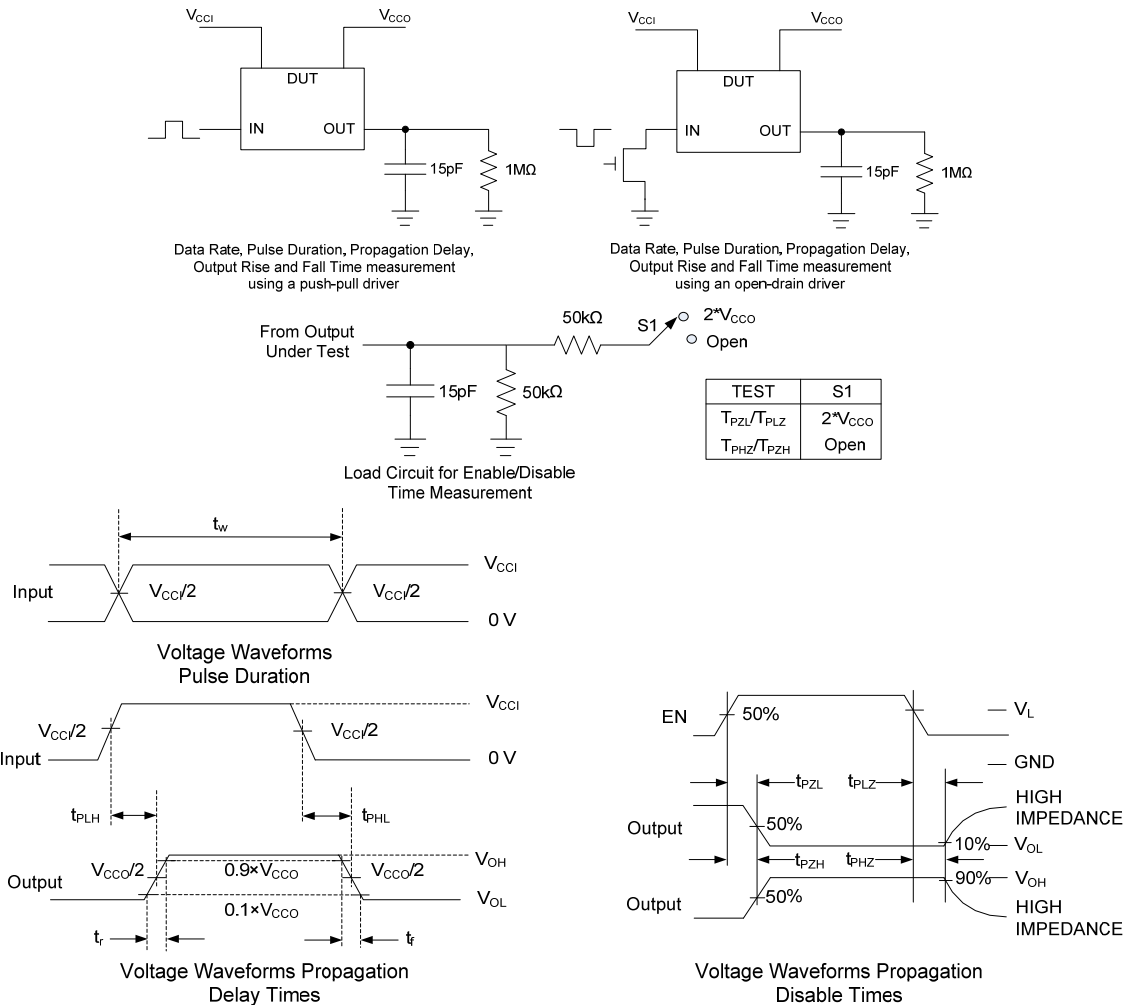

- A. C_L includes probe and jig capacitances.
- B. Waveform 1 is for an output with internal conditions such that the output is low, except when disabled by the output control.
Waveform 2 is for an output with internal conditions such that the output is high, except when disabled by the output control.
- C. All input pulses are supplied by generators having the following characteristics: $PRR \leq 100\text{MHz}$, $Z_0 = 50\Omega$, $dv/dt \geq 1\text{V/ns}$.
- D. The outputs are measured one at a time, with one transition per measurement.
- E. t_{PLZ} and t_{PHZ} are the same as t_{dis} .
- F. t_{PZL} and t_{PZH} are the same as t_{en} .
- G. t_{PLH} and t_{PHL} are the same as t_{pd} .
- H. V_{CCI} is the V_{CC} associated with the input port.
- I. V_{CCO} is the V_{CC} associated with the output port.
- J. All parameters and waveforms are not applicable to all devices.

Figure 2 Load Circuits and Voltage Waveforms

Package Information

UM3204H CSP12 1.9×1.4

Outline Drawing

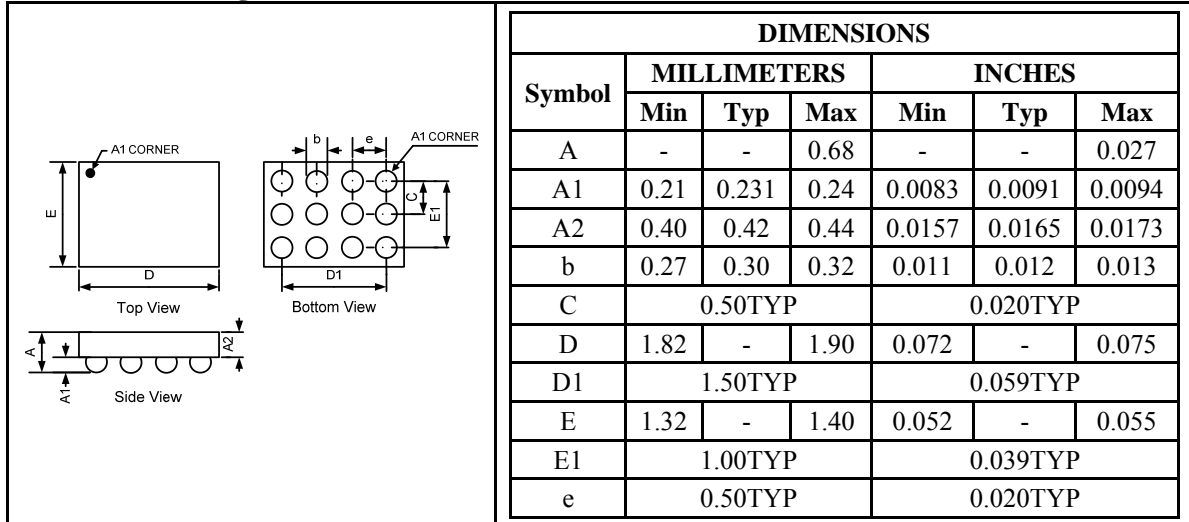

Land Pattern

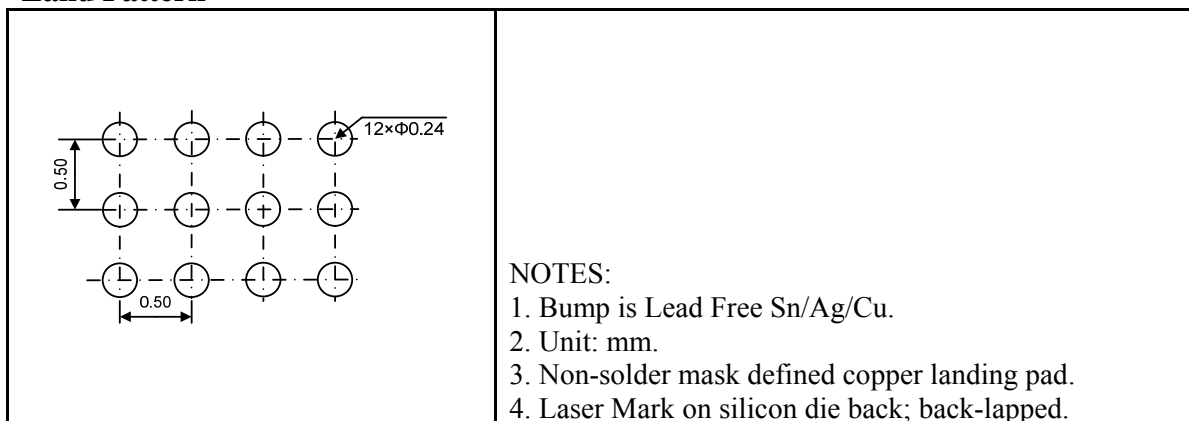

Tape and Reel Orientation

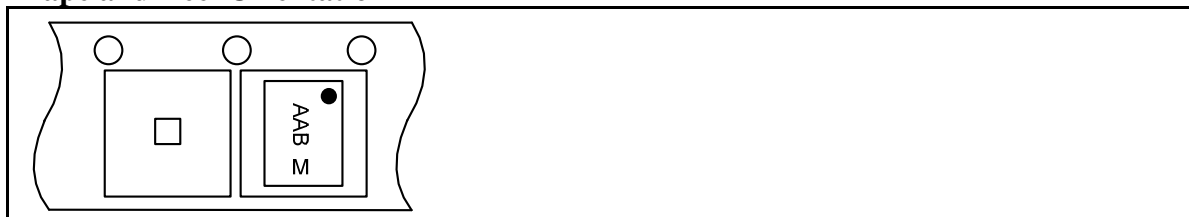

UM3204Q QFN14 3.5×3.5

Outline Drawing

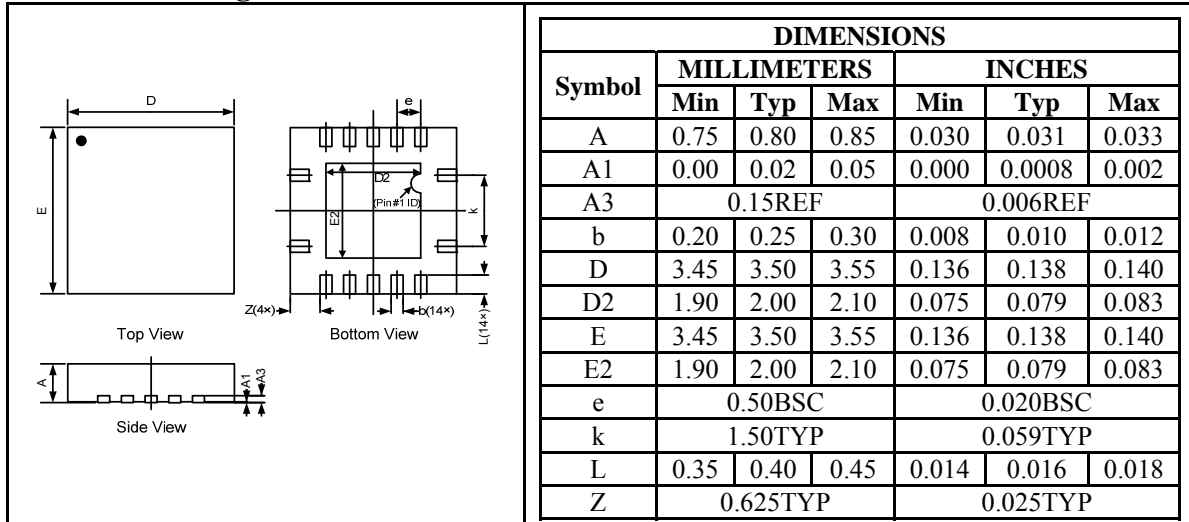

Land Pattern

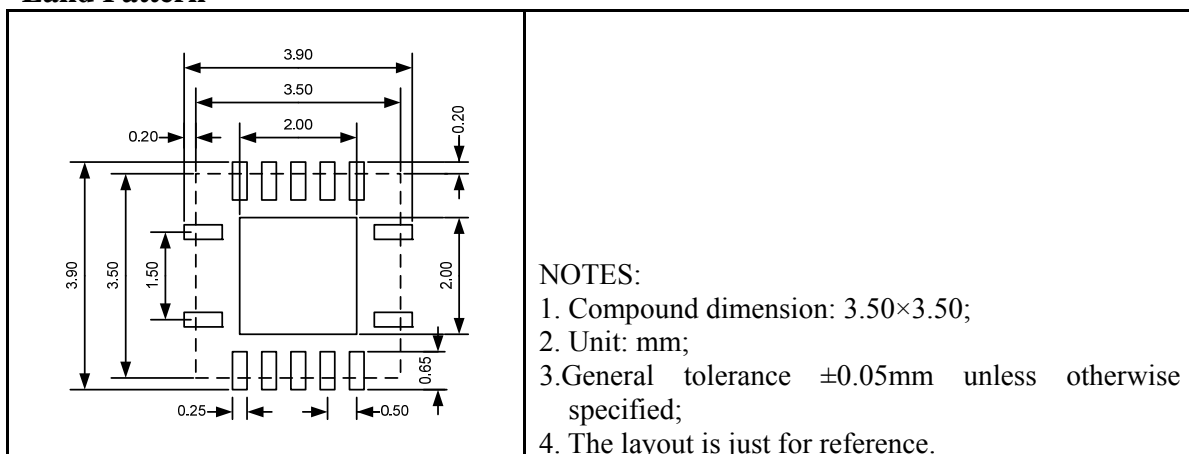

Tape and Reel Orientation



UM3204QS QFN14 3.5×3.5

Outline Drawing

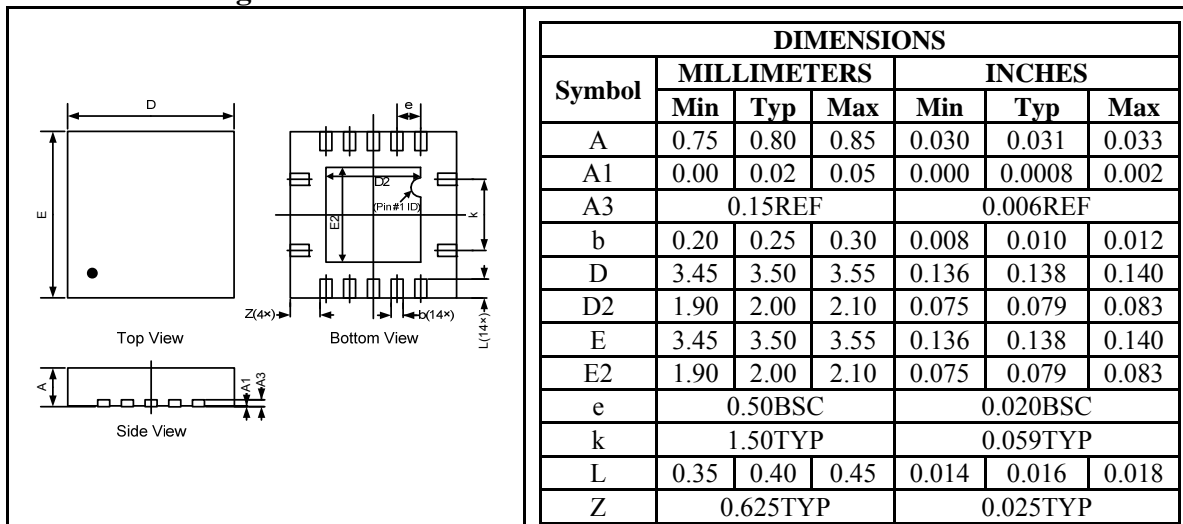

Land Pattern

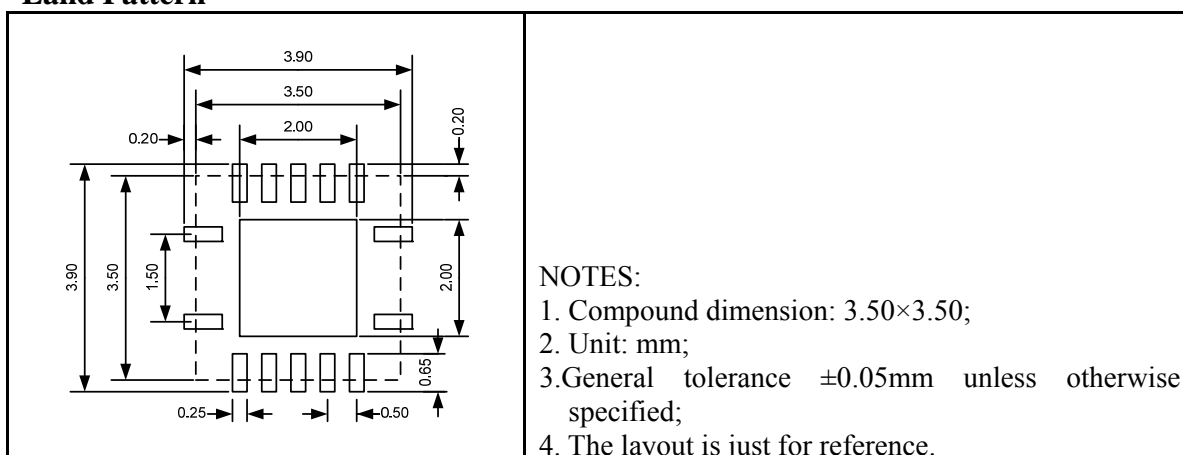

Tape and Reel Orientation

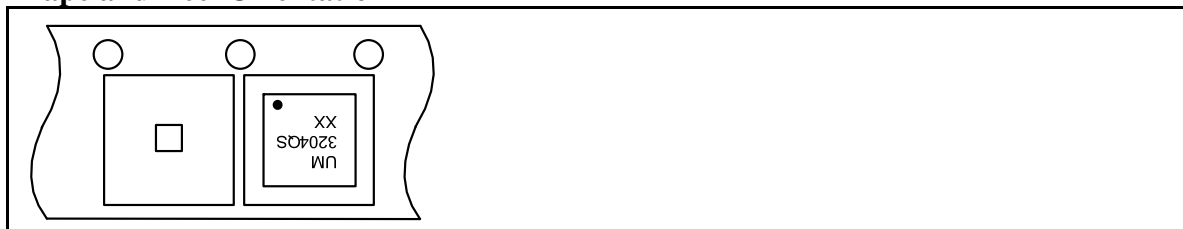

UM3204UE: TSSOP14

Outline Drawing

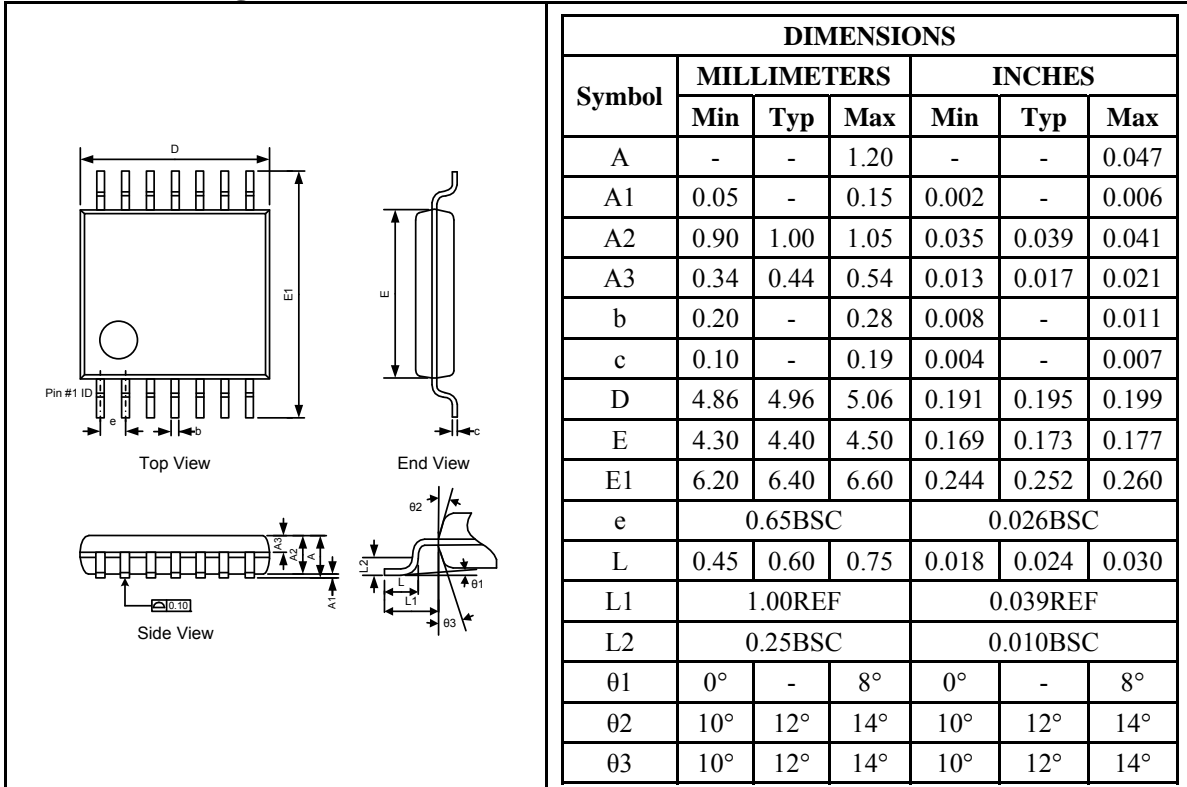

Land Pattern

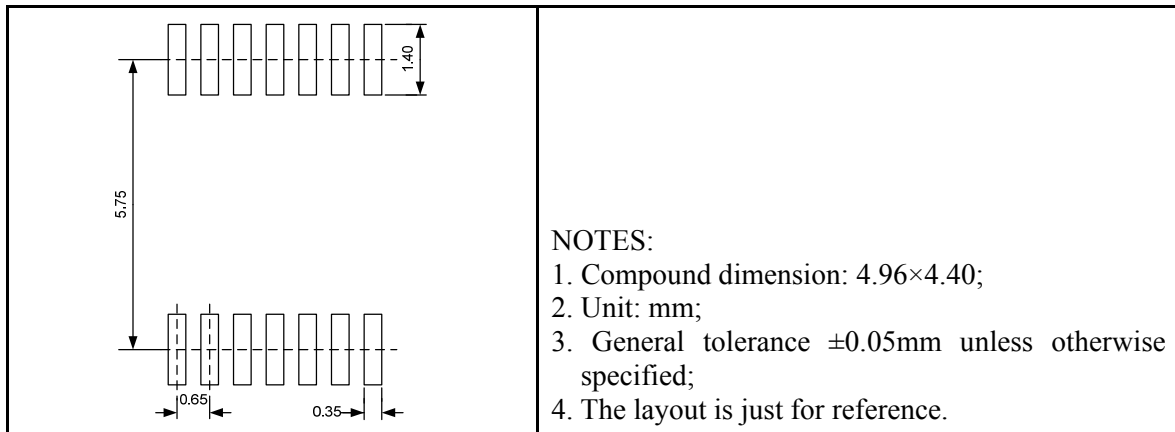

Tape and Reel Orientation



UM3204QT QFN12 1.7×2.0

Outline Drawing

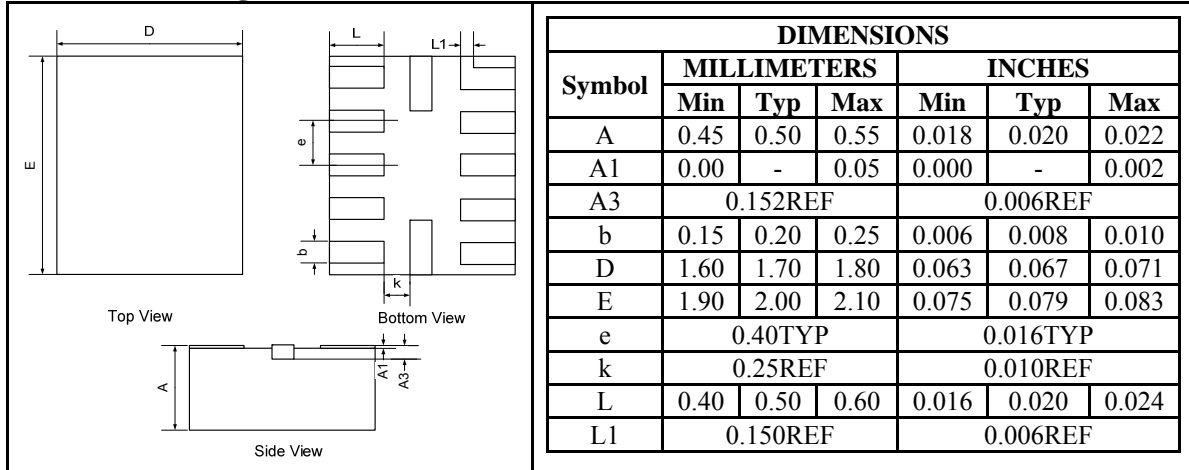

Land Pattern

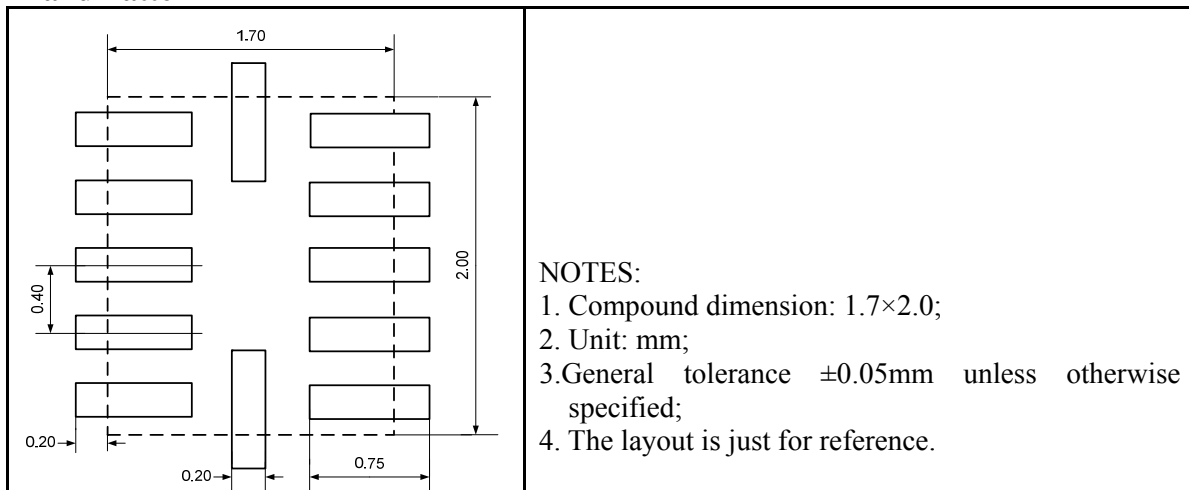

Tape and Reel Orientation

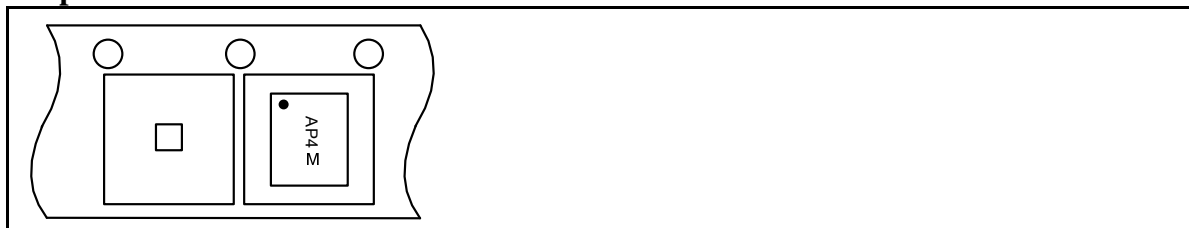

GREEN COMPLIANCE

Union Semiconductor is committed to environmental excellence in all aspects of its operations including meeting or exceeding regulatory requirements with respect to the use of hazardous substances. Numerous successful programs have been implemented to reduce the use of hazardous substances and/or emissions.

All Union components are compliant with the RoHS directive, which helps to support customers in their compliance with environmental directives. For more green compliance information, please visit:

http://www.union-ic.com/index.aspx?cat_code=RoHSDeclaration

IMPORTANT NOTICE

The information in this document has been carefully reviewed and is believed to be accurate. Nonetheless, this document is subject to change without notice. Union assumes no responsibility for any inaccuracies that may be contained in this document, and makes no commitment to update or to keep current the contained information, or to notify a person or organization of any update. Union reserves the right to make changes, at any time, in order to improve reliability, function or design and to attempt to supply the best product possible.



Union Semiconductor, Inc

Add: Unit 606, No.570 Shengxia Road, Shanghai 201210



Tel: 021-51093966

Fax: 021-51026018

Website: www.union-ic.com

Looking for pricing, stock, or lifecycle information?

Click below to explore more details on WIN SOURCE:

-  [View UM3204QT](#) on WIN SOURCE
-  [Union Semiconductor](#) Information

Optimize Your Supply Chain with WIN SOURCE Solutions

-  Global Sourcing Solution
-  Obsolete Management
-  Cost Control Management
-  Shortage Management
-  Alternative Solution
-  Excess Inventory Management