



**THE DATASHEET OF
0997030.WXN**



MINI® Blade Fuses Rated 58V

MINI® style fuse for use in 42V Systems. Same Time-Current characteristic as the 32V MINI® fuse. Fits into standard MINI® fuse sockets. Has a rejection feature to prevent fuses with lower voltage rating from being wrongfully inserted into the circuit. Current rating 2A - 30A @58VDC max.

Specifications

Voltage Rating:	58 VDC
Interrupting Rating:	1000A @ 58 VDC
*Recommended Environmental Temperature:	-40°C to +125°C
Terminals Material:	Silver plated zinc alloy
Housing Materials:	PA66 (U.L. 94 Flammability rating – V2)
Net Weight Per Fuse:	0.57±5% gr
Complies with:	SAE J2077, SAE 2576 ISO 8820 UL 248 Special Purpose Fuses



*Silver plating allows up to 150°C at the terminal interface.



MINI® Blade Fuses

Time-Current Characteristic Curves

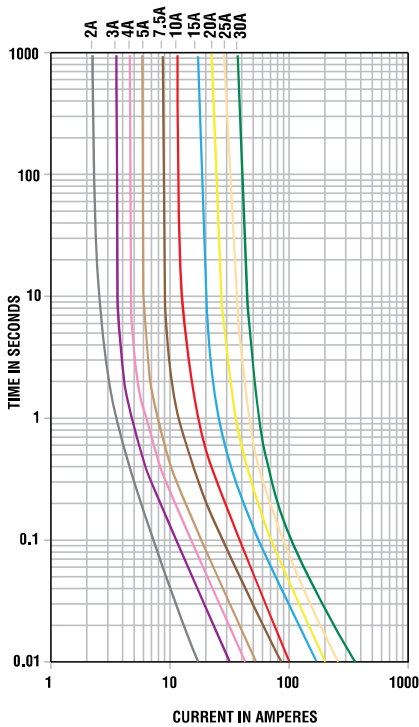

Ordering Information

Part Number	Rating	Package Size
0997xxx.WXN	2 - 30	3000

Time-Current Characteristics

% of Rating	Opening Time Min / Max (s)
110	360,000 / ∞
135	0.75 / 600
200	0.15 / 5
350	0.08 / 0.5
600	0.03 / 0.1

Ratings

Part Number	Current Rating (A)	Housing Material Color	Test Cable Size (mm ²)	Typ. Voltage Drop (mV)	Typ. Cold Resistance (mΩ)	Typ. I ² t (A ² s)
0997002_	2	Grey	0.5	171	55.60	2.8
0997003_	3	Purple	0.5	153	33.75	9.4
0997004_	4	Pink	0.5	121	23.48	17
0997005_	5	Brown	0.5	129	17.75	25
099707.5_	7.5	Dark Brown	0.75	135	10.85	68
0997010_	10	Red	1	108	7.42	93
0997015_	15	Blue	1.5	98	4.58	270
0997020_	20	Yellow	2.5	96	3.21	380
0997025_	25	Light Orange	2.5	86	2.36	625
0997030_	30	Green	4	87	1.85	1,100

The typical I²t is an average value calculated from the breaking capacity tests by using the melting time before the arcing occurs.

REV07122021

Littelfuse® products are not designed for, and shall not be used for, any purpose (including, without limitation, automotive, military, aerospace, medical, life-saving, life-sustaining or nuclear facility applications, devices intended for surgical implant into the body, or any other application in which the failure or lack of desired operation of the product may result in personal injury, death, or property damage) other than those expressly set forth in applicable Littelfuse® product documentation. Warranties granted by Littelfuse® shall be deemed void for products used for any purpose not expressly set forth in applicable Littelfuse® documentation. Littelfuse® shall not be liable for any claims or damages arising out of products used in applications not expressly intended by Littelfuse® as set forth in applicable Littelfuse® documentation. The sale and use of Littelfuse® products is subject to Littelfuse Terms and Conditions of Sale, unless otherwise agreed by Littelfuse®.

MINI® Blade Fuses Rated 58V

Dimensions

Dimensions in mm for reference only.
See outline drawing for dimensions and tolerances.

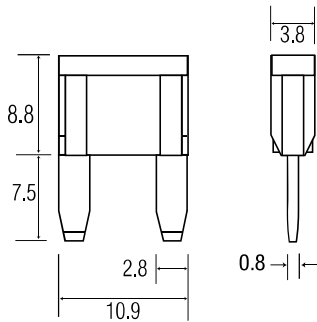

Temperature Table

	max. allowed current load [A] at ambient temperature (typical derating)							
	-40°C	-20°C	0°C	20°C	40°C	60°C	80°C	100°C
2A	2.0	2.0	2.0	1.9	1.7	1.6	1.4	1.3
3A	3.0	2.8	2.7	2.5	2.4	2.2	2.0	1.8
4A	4.0	3.8	3.6	3.4	3.2	2.9	2.7	2.4
5A	5.0	4.8	4.5	4.3	4.0	3.7	3.4	3.0
7.5A	7.5	7.1	6.8	6.4	6.0	5.5	5.1	4.5
10A	10	10	9.8	9.2	8.6	8.0	7.3	6.5
15A	15	15	14	13	12	12	11	9.0
20A	20	19	18	17	16	15	14	12
25A	25	24	22	21	20	18	17	15
30A	30	29	27	26	24	22	20	18

Typical Derating of Fuse Melting Element

Temperature Security Margin is 20%
Please contact Littelfuse® for Details Regarding Derating Test Set-Up.

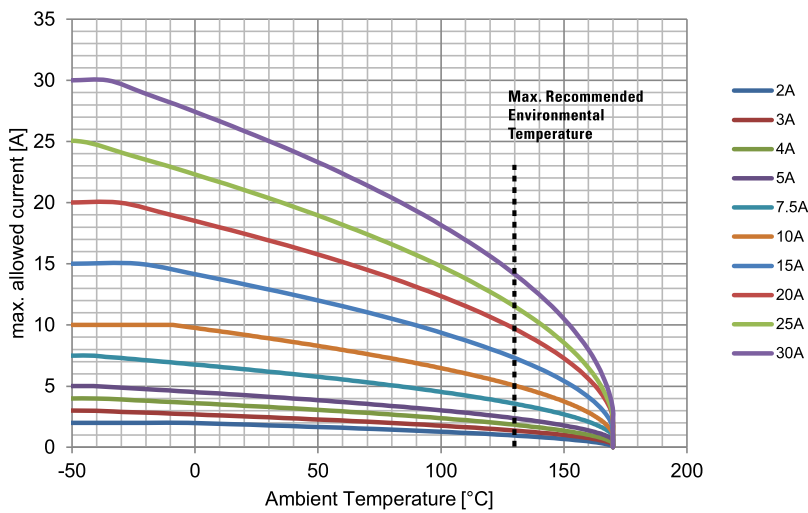



Derating curves may change depending on the final condition of the application (terminals characteristics, wire size etc.).
Please ask Littelfuse® for more information.

REV07122021

Littelfuse® products are not designed for, and shall not be used for, any purpose (including, without limitation, automotive, military, aerospace, medical, life-saving, life-sustaining or nuclear facility applications, devices intended for surgical implant into the body, or any other application in which the failure or lack of desired operation of the product may result in personal injury, death, or property damage) other than those expressly set forth in applicable Littelfuse® product documentation. Warranties granted by Littelfuse® shall be deemed void for products used for any purpose not expressly set forth in applicable Littelfuse® documentation. Littelfuse® shall not be liable for any claims or damages arising out of products used in applications not expressly intended by Littelfuse® as set forth in applicable Littelfuse® documentation. The sale and use of Littelfuse® products is subject to Littelfuse Terms and Conditions of Sale, unless otherwise agreed by Littelfuse®.

Looking for pricing, stock, or lifecycle information?

Click below to explore more details on WIN SOURCE:

-  [View 0997030.WXN on WIN SOURCE](#)
-  [Littelfuse Inc. Information](#)

Optimize Your Supply Chain with WIN SOURCE Solutions

-  Global Sourcing Solution
-  Obsolete Management
-  Cost Control Management
-  Shortage Management
-  Alternative Solution
-  Excess Inventory Management