



**THE DATASHEET OF
TL3342F450QG**



SERIES TL 3342 SWITCHES

TACT SWITCHES SMT

TACT SWITCHES

NAVIGATION SWITCHES

PUSHBUTTON SWITCHES

TOGGLE SWITCHES

ROCKER SWITCHES

SLIDE SWITCHES

SNAP-ACTION SWITCHES

DIP SWITCHES

KEYLOCK SWITCHES

ROTARY SWITCHES

DETECTOR SWITCHES

CAP OPTIONS

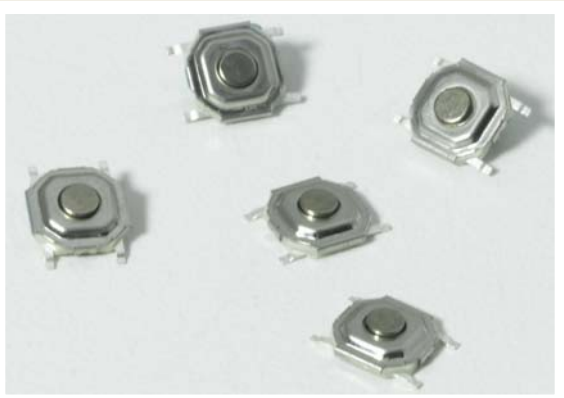

FEATURES & BENEFITS

- ▶ Low profile design
- ▶ Positive tactile response

APPLICATIONS/MARKETS

- ▶ Telecommunications
- ▶ Consumer Electronics
- ▶ Audio/visual
- ▶ Medical
- ▶ Testing/instrumentation
- ▶ Computer/servers/peripherals

SPECIFICATIONS

Contact Rating:	50mA @ 12 VDC
Life Expectancy:	100,000 cycles typical
Contact Resistance:	20mΩ max. initial @ 2-4 VDC, 100mA
Insulation Resistance:	100MΩ
Dielectric Strength:	1,000 Vrms at sea level
Actuation Force:	160± 50 gf, 260± 50 gf
Operating Temperature:	-20°C to 70°C

MATERIALS

Housing:	Polyphenylene Sulfide (PPS) or 4/6 Nylon
Actuator:	Polyphenylene Sulfide (PPS) or 4/6 Nylon
Cover:	Tin plated steel
Contacts:	Silver-clad phosphor bronze
Terminals:	Silver-clad brass

HOW TO ORDER

SERIES	MODEL NO.	ACTUATOR ("L" Dimension)	OPERATING FORCE	CONTACT MATERIAL	TERMINATION
TL	3342	(None) = Std.	F160 F260	Q = Silver	G = Gull Wing

Example Ordering Number
TL-3342-F160-Q-G

Specifications subject to change without notice 11.8.2018

TL 3342

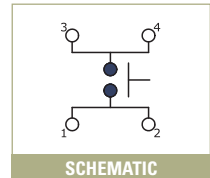
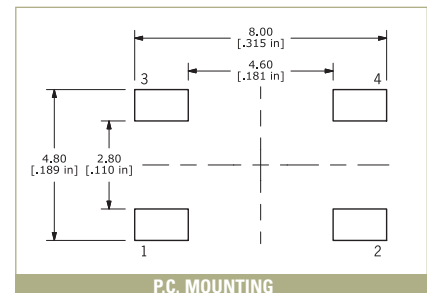
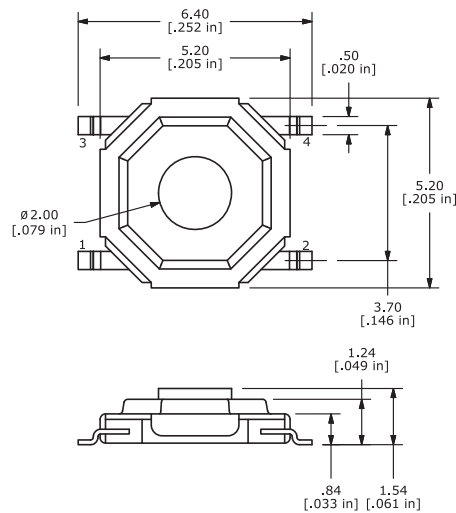







Looking for pricing, stock, or lifecycle information?

Click below to explore more details on WIN SOURCE:

 [View TL3342F450QG on WIN SOURCE](#)

 [E-Switch Information](#)

Optimize Your Supply Chain with WIN SOURCE Solutions

-  Global Sourcing Solution
-  Obsolete Management
-  Cost Control Management
-  Shortage Management
-  Alternative Solution
-  Excess Inventory Management