



**THE DATASHEET OF  
LTC2688HUI-16#TRPBF**



16-Channel, 12-/16-Bit Voltage Output SoftSpan DAC

FEATURES

- ▶ 16 independent SoftSpan DAC channels
- ▶ Independently programmable output ranges: 0 V to 5 V, 0 V to 10 V,  $\pm 5$  V,  $\pm 10$  V,  $\pm 15$  V
- ▶ Full 12-/16-bit resolution at all ranges
- ▶ Flexible single- or dual-supply operation
- ▶ Maximum INL error:  $\pm 3$  LSB<sub>16</sub>,  $\pm 0.75$  LSB<sub>12</sub>
- ▶ Precision 4.096 V reference,  $\pm 5$  ppm/ $^{\circ}$ C maximum
- ▶ A/B toggle or sinusoidal dither using up to 3 toggle pins
- ▶ Multiplexer for output voltage and load current sense
- ▶ Outputs drive  $\pm 20$  mA guaranteed
- ▶ 6 mm  $\times$  6 mm, 40-lead LFCSP and 4.5 mm  $\times$  4.5 mm, 64-ball WLCSP

APPLICATIONS

- ▶ Optical networking
- ▶ Instrumentation
- ▶ Data acquisition
- ▶ Automatic test equipment
- ▶ Process control and industrial automation

FUNCTIONAL BLOCK DIAGRAM

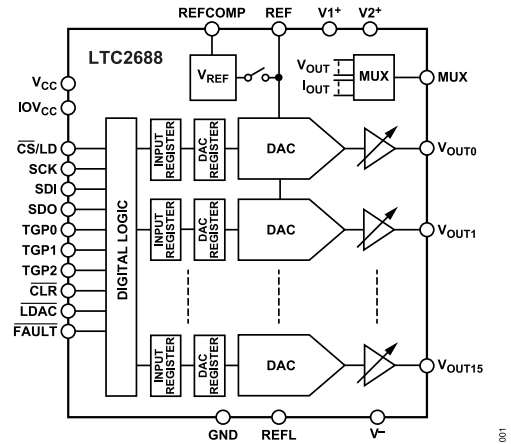

Figure 1.

GENERAL DESCRIPTION

The LTC2688 is a 16-channel, 12-/16-bit,  $\pm 15$  V digital-to-analog converter (DAC) with an integrated precision reference. The LTC2688 is guaranteed monotonic and has built in rail-to-rail output buffers that can source or sink up to 20 mA. This SoftSpan™ DAC offers five output ranges up to  $\pm 15$  V. The range of each channel is independently programmable.

The internal 4.096 V precision reference sets the accuracy of the output voltage. An external reference can be used for additional range options. Three toggle pins support Input Register A and Input Register B toggle or sinusoidal dither at multiple frequencies. An analog multiplexer simplifies measurement of pin voltages, load currents, and junction temperature.

Programmable offset and gain registers improve the accuracy of the DAC outputs.

The serial peripheral interface (SPI) and MICROWIRE™-compatible, 3-wire serial interface operates on logic levels as low as 1.71 V and clock rates up to 50 MHz.

## TABLE OF CONTENTS

Features.....	1	Read Commands.....	24
Applications.....	1	Offset and Gain Adjustment.....	26
Functional Block Diagram.....	1	Analog Mux.....	28
General Description.....	1	Toggle and Dither Operation.....	29
Specifications.....	4	Daisy-Chain Mode.....	36
Timing Characteristics.....	6	Power-Down Mode.....	36
Absolute Maximum Ratings.....	8	Asynchronous DAC Update Using $\overline{\text{LDAC}}$ .....	38
Thermal Resistance.....	8	Fault Detection.....	38
Electrostatic Discharge (ESD) Ratings.....	8	Configuration Register.....	39
ESD Caution.....	8	Reference Modes.....	39
Pin Configuration and Function Descriptions.....	9	Voltage Outputs.....	39
Typical Performance Characteristics.....	12	Thermal Overload Protection.....	40
Terminology.....	19	Applications Information.....	41
Theory of Operation.....	20	Printed Circuit Board Layout.....	41
Power-On Reset.....	20	Command Addresses.....	42
Power Supply Sequencing.....	20	Outline Dimensions.....	44
Serial Interface.....	21	Ordering Guide.....	45
Writing Codes to DACs.....	23	Evaluation Boards.....	45
Span Selection and Channel Settings.....	24		

## REVISION HISTORY

### 1/2023—Rev. B to Rev. C

Changes to Table 2.....	6
-------------------------	---

### 11/2022—Rev. A to Rev. B

Changes to Data Sheet Title.....	1
Changes to Features Section.....	1
Changes to General Description Section.....	1
Changes to Table 1.....	4
Changes to Table 2.....	6
Changes to Figure 26 Caption, Figure 27 Caption, and Figure 28 Caption.....	15
Added Figure 30, Figure 31, Figure 32, and Figure 33; Renumbered Sequentially.....	16
Added Table 11; Renumbered Sequentially.....	23
Changes to Table 12 Title.....	23
Changes to Figure 51 Caption.....	24
Added Figure 52.....	24
Changes to Table 20 Title.....	26
Added Table 21.....	26
Changes to Gain Adjustment Section.....	27
Changes to Table 23 Title.....	27
Added Table 24 and Table 25.....	27
Changes to Example of Dither Operation Section.....	31
Changes to Table 43.....	42
Changes to Ordering Guide.....	45
Changes to Evaluation Boards.....	45

### 8/2022—Rev. 0 to Rev. A

Added 64-Ball WLCSP (Universal).....	1
--------------------------------------	---

**TABLE OF CONTENTS**

Changes to Features Section.....	1
Changes to Figure 1.....	1
Changes to Reference Temperature Coefficient Parameter and Output Noise Spectral Density Parameter, Table 1.....	4
Added Electrostatic Discharge (ESD) Ratings Section.....	8
Changes to Table 4.....	8
Added ESD Ratings for LTC2688 Section and Table 5; Renumbered Sequentially.....	8
Added Figure 4 and Table 7; Renumbered Sequentially.....	10
Changes to Figure 5 Caption.....	12
Changes to Figure 43.....	20
Changes to Power Supply Sequencing Section.....	20
Changes to Figure 44.....	21
Changes to Figure 47 Caption.....	24
Changes to Analog Mux Section.....	28
Changes to Figure 48.....	29
Changes to Toggle Operations Example Section.....	30
Changes to Figure 50.....	30
Changes to Printed Circuit Board Layout Section.....	41
Change to Table 39.....	42
Updated Outline Dimensions.....	44
Changes to Ordering Guide.....	45
Changes to Evaluation Boards.....	45

**6/2021—Revision 0: Initial Version**

## SPECIFICATIONS

All specifications apply over the full operating temperature range, unless otherwise noted. Typical values are at  $T_A = 25^\circ\text{C}$ .  $V_{CC} = 5\text{ V}$ ,  $IOV_{CC} = 5\text{ V}$ ,  $V1^+ = V2^+ = 15\text{ V}$ ,  $V^- = -15\text{ V}$ ,  $V_{REF} = 4.096\text{ V}$ ,  $V_{OUT}$  unloaded, unless otherwise specified. For  $\pm 15\text{ V}$  range,  $V1^+ = V2^+ = 18\text{ V}$ ,  $V^- = -18\text{ V}$ .

Table 1.

Parameter	Symbol	Test Conditions/Comments	Min	Typ	Max	Unit
<b>DC PERFORMANCE</b>						
LTC2688-16						
Resolution			16			Bits
Monotonicity		All ranges <sup>1</sup>	16			Bits
Differential Nonlinearity	DNL	All ranges <sup>1</sup>			$\pm 1$	LSB
Integral Nonlinearity	INL	All ranges <sup>1</sup>			$\pm 3$	LSB
LTC2688-12						
Resolution			12			Bits
Monotonicity		All ranges <sup>1</sup>	12			
Differential Nonlinearity	DNL	All ranges <sup>1</sup>			$\pm 0.25$	LSB
Integral Nonlinearity	INL	All ranges <sup>1</sup>			$\pm 0.75$	LSB
Unipolar Offset Error	$V_{OS}$	0 V to 5 V range		$\pm 0.5$	$\pm 2$	mV
		0 V to 10 V range		$\pm 1$	$\pm 4$	mV
$V_{OS}$ Temperature Coefficient		All unipolar ranges		1		ppm/ $^\circ\text{C}$
Single-Supply Zero-Scale Error	ZSE	All unipolar ranges, $V^- = \text{GND}$		2	4	mV
Bipolar Zero Error	BZE	All bipolar ranges			$\pm 0.04$	% FSR <sup>2</sup>
BZE Temperature Coefficient		All bipolar ranges		2		ppm/ $^\circ\text{C}$
Gain Error	GE	All ranges, external reference			$\pm 0.08$	% FSR <sup>2</sup>
Gain Temperature Coefficient				2		ppm/ $^\circ\text{C}$
Output Voltage Swing	$V_{OUT}$	To $V^-$ (unloaded)		$V^- + 0.004$		V
		To $Vx^+$ (unloaded)		$Vx^+ - 0.004$		V
		To $V^-$ ( $-20\text{ mA} \leq I_{OUT} \leq +20\text{ mA}$ ), $\pm 15\text{ V}$ range			$V^- + 2.2$	V
		To $Vx^+$ ( $-20\text{ mA} \leq I_{OUT} \leq +20\text{ mA}$ ), $\pm 15\text{ V}$ range	$Vx^+ - 2.2$			V
Power Supply Rejection	PSR	$V_{CC} = 5\text{ V} \pm 5\%$		-80		dB
		$Vx^+/V^- = 15\text{ V} \pm 5\%$		-80		dB
Load Regulation		$-20\text{ mA} \leq I_{OUT} \leq +20\text{ mA}$ , $Vx^+ = +17.2\text{ V}$ , $V^- = -17.2\text{ V}$ , $\pm 15\text{ V}$ range		70	150	$\mu\text{V}/\text{mA}$
DC Crosstalk <sup>3</sup> , 0 V to 5 V Range		Due to full-scale output change		$\pm 2$		$\mu\text{V}$
		Due to load current change		$\pm 1$		$\mu\text{V}/\text{mA}$
		Due to powering down (per channel)		$\pm 4$		$\mu\text{V}$
$Vx^+/V^-$ Short-Circuit Output Current <sup>4</sup> , $\pm 15\text{ V}$ Output Range	$I_{SC}$	Negative full scale, forcing output to GND	-41			mA
		Positive full scale, forcing output to GND			41	mA
<b>REFERENCE</b>						
Reference Output Voltage <sup>5</sup>			4.094	4.096	4.098	V
		$T_A = T_{MIN}$ to $T_{MAX}$	4.092	4.096	4.100	V
Reference Temperature Coefficient <sup>6</sup>						
LFCSP Package				$\pm 2$	$\pm 5$	ppm/ $^\circ\text{C}$
WLCSP Package				$\pm 5$		ppm/ $^\circ\text{C}$
Line Regulation		$V_{CC} \pm 5\%$		-80		dB
Short-Circuit Current		Forcing output to GND		0.1		mA
REFCOMP Pin Short-Circuit Current		Forcing output to GND		10		$\mu\text{A}$
Load Regulation		$I_{OUT} = 1\text{ }\mu\text{A}$		320		mV/mA
Output Voltage Noise Density		REFCOMP, capacitor ( $C_{REFCOMP}$ ) = REF capacitor ( $C_{REF}$ ) = $0.1\text{ }\mu\text{F}$ , at $f = 10\text{ kHz}$		32		nV/ $\sqrt{\text{Hz}}$

## SPECIFICATIONS

Table 1. (Continued)

Parameter	Symbol	Test Conditions/Comments	Min	Typ	Max	Unit
<b>REFERENCE INPUT</b>						
Range		External reference mode <sup>7</sup>	2.0		$V_{CC} - 0.6$	V
Current				10	15	$\mu$ A
Capacitance				8		pF
<b>POWER SUPPLY</b>						
Analog Supply Voltage	$V_{CC}$		4.75		5.25	V
Analog Positive Supply	$V1^+$		$V_{CC} - 0.3$		$V^- + 42$	V
	$V2^+$		$V_{CC} - 0.3$		$V1^+ + 0.3$	V
Analog Negative Supply	$V^-$		-21		0	V
Digital Input/Output (I/O) Supply Voltage	$IOV_{CC}$		1.71		$V_{CC} + 0.3$	V
Supply Current						
$V_{CC}$ <sup>8</sup>	$I_{V_{CC}}$	$V_{CC} = 5$ V; 0 V to 5 V range		21.9		mA
		$V_{CC} = 5$ V; 0 V to 10 V range		22.3		mA
		$V_{CC} = 5$ V; $\pm 5$ V range		25.6		mA
		$V_{CC} = 5$ V; $\pm 10$ V range		29.6		mA
		$V_{CC} = 5$ V; $\pm 15$ V range		33.6	37.0	mA
$Vx^+/V^-$ <sup>9</sup>	$I_S$	$Vx^+/V^- = \pm 15$ V; 0 V to 5 V range		6.4		mA
		$Vx^+/V^- = \pm 15$ V; 0 V to 10 V range		6.4		mA
		$Vx^+/V^- = \pm 15$ V; $\pm 5$ V range		8.3		mA
		$Vx^+/V^- = \pm 15$ V; $\pm 10$ V range		10.8		mA
		$Vx^+/V^- = \pm 15$ V; $\pm 15$ V range		13	15	mA
$IOV_{CC}$	$I_{IOV_{CC}}$	$IOV_{CC} = 5$ V, digital inputs at $IOV_{CC}$ or GND		0.05	1	$\mu$ A
Shutdown Supply Current						
$V_{CC}$		$V_{CC} = 5$ V		20		$\mu$ A
$V^+$		$V^+/V^- = \pm 15$ V		30		$\mu$ A
$V^-$		$V^+/V^- = \pm 15$ V		-30		$\mu$ A
<b>ANALOG MUX</b>						
MUX DC Output Impedance				3.5		k $\Omega$
MUX Leakage Current					1	$\mu$ A
MUX Output Voltage Range			$V^-$		$V1^+ - 1.4$	V
MUX Continuous Current <sup>10</sup>					0.2	mA
Junction Temperature Sense Slope				7.95		mV/ $^{\circ}$ C
Junction Temperature Accuracy				$\pm 5$		$^{\circ}$ C
<b>AC PERFORMANCE</b>						
Settling Time	$t_{SETTLE}$					$\mu$ s
0 V to 5 V Range, $\pm 5$ V Step		0.0015% ( $\pm 1$ LSB <sub>16</sub> )		<10		$\mu$ s
		0.024% ( $\pm 1$ LSB <sub>12</sub> )		6.5		$\mu$ s
0 V to 10 V Range or $\pm 5$ V Range, $\pm 10$ V Step		0.0015% ( $\pm 1$ LSB <sub>16</sub> )		<11		$\mu$ s
		0.024% ( $\pm 1$ LSB <sub>12</sub> )		8.6		$\mu$ s
$\pm 10$ V Range, $\pm 20$ V Step		0.0015% ( $\pm 1$ LSB <sub>16</sub> )		<20		$\mu$ s
		0.024% ( $\pm 1$ LSB <sub>12</sub> )		15		$\mu$ s
$\pm 15$ V Range, $\pm 30$ V Step		0.0015% ( $\pm 1$ LSB <sub>16</sub> )		<28		$\mu$ s
		0.024% ( $\pm 1$ LSB <sub>12</sub> )		21		$\mu$ s
Voltage Output Slew Rate	SR			>3.5		V/ $\mu$ s
Capacitive Load Driving				1000		pF
Glitch Impulse <sup>11</sup>		At midscale transition, 0 V to 5 V range		7		nV-sec
DAC to DAC Crosstalk <sup>12</sup>		Due to full-scale output change, 0 V to 5 V range		1		nV-sec
Output Noise Spectral Density	$e_n$	0 V to 5 V output range, internal reference				

## SPECIFICATIONS

Table 1. (Continued)

Parameter	Symbol	Test Conditions/Comments	Min	Typ	Max	Unit
		At f = 1 kHz		60		nV/ $\sqrt{\text{Hz}}$
		At f = 10 kHz		45		nV/ $\sqrt{\text{Hz}}$
		0.1 Hz to 10 Hz		1.7		$\mu\text{V rms}$
		0.1 Hz to 200 kHz		30		$\mu\text{V rms}$
DIGITAL INPUT/OUTPUT (I/O)						
Digital Output High Voltage	$V_{OH}$	SDO pin, load current = $-100 \mu\text{A}$	$\text{IOV}_{CC} - 0.2$			V
Digital Output Low Voltage	$V_{OL}$	SDO pin, load current = $100 \mu\text{A}$			0.2	V
		$\overline{\text{FAULT}}$ pin, load current = $100 \mu\text{A}$			0.2	V
Digital High-Z Output Leakage	$I_{OZ}$	SDO pin leakage current ( $\overline{\text{CS}}/\text{LD}$ high)			$\pm 1$	$\mu\text{A}$
		$\overline{\text{FAULT}}$ pin leakage current (not asserted)			1	$\mu\text{A}$
Digital Input Leakage	$I_{LK}$	$V_{IN} = \text{GND to IOV}_{CC}$			$\pm 1$	$\mu\text{A}$
Digital Input Capacitance <sup>10</sup>	$C_{IN}$				8	pF
$\text{IOV}_{CC} = 2.7 \text{ V to } V_{CC}$						
Digital Input High Voltage	$V_{IH}$		$0.8 \times \text{IOV}_{CC}$			V
Digital Input Low Voltage	$V_{IL}$				0.5	V
$\text{IOV}_{CC} = 1.71 \text{ V to } 2.7 \text{ V}$						
Digital Input High Voltage	$V_{IH}$		$0.8 \times \text{IOV}_{CC}$			V
Digital Input Low Voltage	$V_{IL}$				0.3	V

<sup>1</sup> Output ranges include 0 V to 5 V, 0 V to 10 V,  $\pm 5 \text{ V}$ ,  $\pm 10 \text{ V}$ , and  $\pm 15 \text{ V}$ .

<sup>2</sup> FSR is full-scale range.

<sup>3</sup> DC crosstalk is measured using the internal reference. The conditions of one DAC channel are changed as specified, and the output of an adjacent channel (at midscale) is measured before and after the change.

<sup>4</sup> This IC includes current limiting that is intended to protect the device during momentary overload conditions. Junction temperature can exceed the rated maximum during current limiting. Continuous operation above the specified maximum operating junction temperature may impair device reliability.

<sup>5</sup> Reference voltage output is production tested using a socket. Mechanical stress caused by soldering parts to a printed circuit board may cause the output voltage to shift and temperature coefficient to change. See the [Printed Circuit Board Layout](#) section.

<sup>6</sup> Temperature coefficient is calculated by dividing the maximum change in output voltage by the specified temperature range.

<sup>7</sup> GE, BZE, and  $V_{OS}$  specifications can degrade for reference input voltages less than 3 V. See [Figure 5](#), [Figure 6](#), and [Figure 12](#) in the [Typical Performance Characteristics](#) section.

<sup>8</sup> Internal reference on.  $\text{IV}_{CC}$  measured with all channels at zero scale for unipolar ranges and negative full scale for bipolar ranges.

<sup>9</sup>  $V_{x^+}$  current ( $I_{V^+}$ ) is measured with all channels at full scale.  $V^-$  current ( $I_{V^-}$ ) is measured with all channels at zero scale for unipolar ranges and negative full scale for bipolar ranges.

<sup>10</sup> Guaranteed by design; not production tested.

<sup>11</sup> 0 V to 5 V range, internal reference mode. DAC is stepped  $\pm 1$  LSB between half scale and half scale – 1 LSB. Load is 2 k $\Omega$  in parallel with 200 pF to GND.

<sup>12</sup> DAC to DAC crosstalk is the glitch that appears at the output of one DAC due to full-scale change at the output of another DAC. 0 V to 5 V range with internal reference. The measured DAC is at midscale.

## TIMING CHARACTERISTICS

All specifications apply over the full operating temperature range, unless otherwise noted. Typical values are at  $T_A = 25^\circ\text{C}$ .  $V_{CC} = 4.75 \text{ V to } 5.25 \text{ V}$ ,  $\text{IOV}_{CC} = 1.71 \text{ V to } V_{CC}$ .  $C_{LOAD}$  is load capacitance.  $\text{IOV}_{CC} = 2.7 \text{ V to } V_{CC}$ , unless otherwise noted. See [Figure 2](#).

Table 2.

Parameter	Description	Min	Typ	Max	Unit
$t_1$	SDI valid to SCK setup	3			ns
$t_2$	SDI valid to SCK hold	3			ns
$t_3$	SCK high time	6			ns

## SPECIFICATIONS

Table 2. (Continued)

Parameter	Description	Min	Typ	Max	Unit
$t_4$	SCK low time	6			ns
$t_5$	$\overline{CS}/LD$ pulse width	8			ns
$t_6$	LSB SCK high to $\overline{CS}/LD$ high	5			ns
$t_7$	$\overline{CS}/LD$ low to SCK high	5			ns
$t_8$	SDO propagation delay from SCK falling edge, $C_{LOAD} = 10$ pF, $IOV_{CC} = 2.7$ V to 5.25 V			25	ns
	SDO propagation delay from SCK falling edge, $C_{LOAD} = 10$ pF, $IOV_{CC} = 1.7$ V to 2.7 V			60	ns
$t_9$	$\overline{CLR}$ pulse width	8			ns
$t_{10}$	$\overline{CS}/LD$ high to SCK positive edge	4			ns
$t_{11}$	$\overline{LDAC}$ pulse width	8			ns
$t_{12}$	$\overline{CS}/LD$ high to $\overline{LDAC}$ high or low transition <sup>1</sup>	8			ns
$f_{SCK}$	SCK frequency			50	MHz
$t_{13}$	TGPx high time		0.25		$\mu$ s
$t_{14}$	TGPx low time <sup>2</sup>		0.25		$\mu$ s

<sup>1</sup> Value of  $t_{12}$  is not valid for write code to all DAC channels. For write code to all DAC channels, the typical value of  $t_{12}$  is 320 ns.

<sup>2</sup> Guaranteed by design but not production tested.

## Timing Diagram

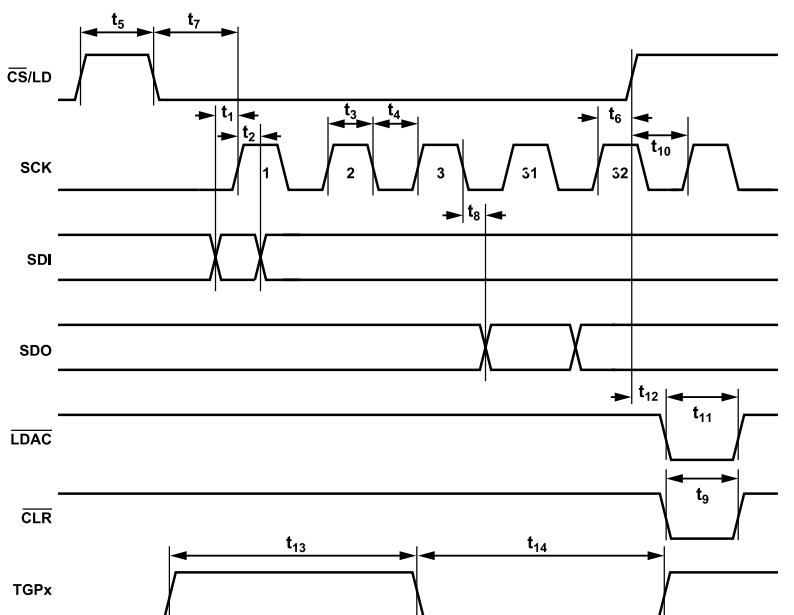

Figure 2. Serial Interface Timing Diagram

## ABSOLUTE MAXIMUM RATINGS

Table 3.

Parameter	Rating
$V_{CC}$ to GND	-0.3 V to +6 V
$IOV_{CC}$ to GND	-0.3 V to +6 V
REFL to GND	-0.3 V to +0.3V
$V1^+$ to GND	-0.3 V to +22 V
$V2^+$ to GND	-0.3 V to $V1^+$ , or -0.3 V to +22 V (whichever is smaller)
$V^-$ to GND	-22V to +0.3 V
$V1^+$ to $V^-$	-0.3 V to +44 V
$V2^+$ to $V^-$	-0.3 V to +44 V
Mux Continuous DC Output Current	$\pm 200 \mu A$
$\overline{CS/LD}$ , SCK, SDI	-0.3 V to $IOV_{CC} + 0.3 V$ or -0.3 V to +6 V (whichever is smaller)
$\overline{LDAC}$ , $\overline{CLR}$ , $\overline{FAULT}$ to GND	-0.3 V to $IOV_{CC} + 0.3 V$ or -0.3 V to +6 V (whichever is smaller)
TGP0, TGP1, TGP2 to GND	-0.3 V to $IOV_{CC} + 0.3 V$ or -0.3 V to +6 V (whichever is smaller)
$V_{OUT0}$ to $V_{OUT15}$ , MUX to GND	$V^- - 0.3 V$ to $Vx^+ + 0.3 V$ , or $\pm 22 V$
REF, REFCOMP	-0.3 V to $V_{CC} + 0.3 V$ or -0.3 V to 6 V (whichever is smaller)
SDO	-0.3 V to $IOV_{CC} + 0.3 V$ or -0.3 V to 6 V (whichever is smaller)
Temperature	
Operating Range	
LTC2688C	0°C to 70°C
LTC2688I	-40°C to +85°C
LTC2688H	-40°C to +125°C
Storage Range	-65°C to +150°C
Junction, $T_{JMAX}$	150°C

Stresses at or above those listed under Absolute Maximum Ratings may cause permanent damage to the product. This is a stress rating only; functional operation of the product at these or any other conditions above those indicated in the operational section of this specification is not implied. Operation beyond the maximum operating conditions for extended periods may affect product reliability.

## THERMAL RESISTANCE

Thermal performance is directly linked to printed circuit board (PCB) design and operating environment. Careful attention to PCB thermal design is required.

$\theta_{JA}$  is the natural convection junction to ambient thermal resistance measured in a one-cubic foot sealed enclosure.  $\theta_{JC}$  is the junction to case thermal resistance.

Table 4. Thermal Resistance

Package Type	$\theta_{JA}$	$\theta_{JC}$	Unit
05-08-1728 <sup>1</sup>	33	2	°C/W
CB-64-5	32.2	0.2	°C/W

<sup>1</sup> Thermal impedance simulated values are based on JEDEC 2S2P thermal test board with no bias. See JEDEC JESD-51.

## ELECTROSTATIC DISCHARGE (ESD) RATINGS

The following ESD information is provided for handling of ESD-sensitive devices in an ESD protected area only.

Human body model (HBM) per ANSI/ESDA/JEDEC JS-001.

Field induced charged device model (FICDM) per ANSI/ESDA/JEDEC JS-002.

### ESD Ratings for LTC2688

Table 5. LTC2688, 40-Lead LFCSP and 64-Ball WLCSP

ESD Model	Withstand Threshold (V)	Class
HBM	3500	2
FICDM	500	C4

## ESD CAUTION



**ESD (electrostatic discharge) sensitive device.** Charged devices and circuit boards can discharge without detection. Although this product features patented or proprietary protection circuitry, damage may occur on devices subjected to high energy ESD. Therefore, proper ESD precautions should be taken to avoid performance degradation or loss of functionality.

## PIN CONFIGURATION AND FUNCTION DESCRIPTIONS

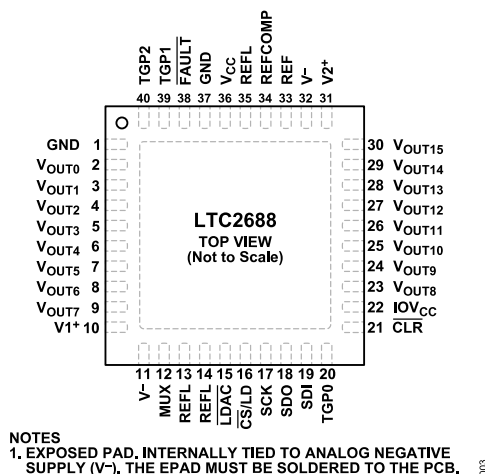

Figure 3. LFCSP Pin Configuration

Table 6. Pin Function Descriptions—LFCSP

Pin No.	Mnemonic	Description
1, 37	GND	Analog Ground. Tie GND to a clean analog ground plane.
2 to 9, 23 to 30	V <sub>OUT0</sub> to V <sub>OUT15</sub>	DAC Analog Voltage Outputs.
10	V1 <sup>+</sup>	Analog Positive Supply for the V <sub>OUT0</sub> to V <sub>OUT7</sub> DAC Outputs. Bypass V1 <sup>+</sup> to GND with a 1 μF capacitor. V1 <sup>+</sup> must be greater than or equal to V2 <sup>+</sup> .
11, 32	V <sup>-</sup>	Analog Negative Supply. Bypass V <sup>-</sup> to GND with a 1 μF capacitor unless V <sup>-</sup> is connected to GND.
12	MUX	Analog Multiplexer Output. Any of the 16 DAC output pin voltages, current load sense voltages (V <sub>SENSE</sub> ), and junction temperatures can be monitored by measuring the voltage at the MUX pin. When the mux is disabled, the MUX pin becomes high impedance. A full listing of available mux functions is given in Table 26.
13, 14, 35	REFL	Reference Low Pins. Signal ground for all DAC channels and internal reference. Tie the REFL pins to a clean analog ground plane.
15	LDAC	Active Low Asynchronous DAC Update Pin. When CS/LD is high, a falling edge on LDAC updates all DAC registers with the contents of the input registers. When LDAC is low, a rising edge on CS/LD similarly updates all DAC registers. Logic levels are determined by IOV <sub>CC</sub> . If the LDAC pin is not used, tie it high to IOV <sub>CC</sub> . Updates can then be performed through SPI commands.
16	CS/LD	Serial Interface Chip Select/Load Input. When CS/LD is low, SCK is enabled for shifting data on SDI into the register. When CS/LD is taken high, SCK is disabled and the specified command (see Table 8 and Table 9) is executed. Logic levels are determined by IOV <sub>CC</sub> .
17	SCK	Serial Interface Clock Input. Logic levels are determined by IOV <sub>CC</sub> .
18	SDO	Serial Interface Data Output. Data is clocked out onto SDO by the falling edge of SCK. SDO is high impedance when CS/LD is high. Logic levels are determined by IOV <sub>CC</sub> .
19	SDI	Serial Interface Data Input. Data on SDI is clocked into the DAC on the rising edge of SCK. The LTC2688 accepts input word lengths of 24 bits or 32 bits. Logic levels are determined by IOV <sub>CC</sub> .
20, 39, 40	TGP0, TGP1, TGP2	Asynchronous Toggle and Sinusoidal Dither Multifunctional Pins. In toggle mode, a falling edge updates the DAC register with data from Input Register A and a rising edge updates the DAC register with data from Input Register B. In sinusoidal dither mode, the toggle pins function as dither clock inputs. DAC outputs update on the rising edge. Toggle and dither operations only affect those DAC channels with their toggle/dither enable bit (ENX) set to 1. When neither toggle nor dither operations are used, tie the TGPx pins to GND, and set EN to 0. Logic levels are determined by IOV <sub>CC</sub> .
21	CLR	Active Low Asynchronous Clear Input. A logic low at this level-triggered input clears the device to zero-scale code and a 0 V to 5 V span range. The control registers are cleared to default values. Logic levels are determined by IOV <sub>CC</sub> .
22	IOV <sub>CC</sub>	Digital Input/Output Supply Voltage. 1.71 V ≤ IOV <sub>CC</sub> ≤ V <sub>CC</sub> + 0.3 V. Bypass IOV <sub>CC</sub> to GND with a 0.1 μF capacitor.
31	V2 <sup>+</sup>	Analog Positive Supply for the V <sub>OUT8</sub> to V <sub>OUT15</sub> DAC Outputs. Bypass the V2 <sup>+</sup> pin to GND with a 1 μF capacitor. V2 <sup>+</sup> must be less than or equal to V1 <sup>+</sup> .
33	REF	Reference Input/Output. The voltage at the REF pin sets the full-scale range of all channels. By default, the internal reference is routed to this pin. The REF pin must be buffered when driving external dc load currents. When set to external reference mode, the internal reference is disconnected, and the REF pin becomes a high impedance input to which a precision external reference can be applied. For low noise and reference stability, tie a capacitor from the REF pin to GND. The value must be

## PIN CONFIGURATION AND FUNCTION DESCRIPTIONS

Table 6. Pin Function Descriptions—LFCSP (Continued)

Pin No.	Mnemonic	Description
34	REFCOMP	less than the capacitance at the REFCOMP pin. In external reference mode, the allowable reference input voltage range is 2.0 V to $V_{CC} - 0.6$ V. Internal Reference Compensation. For low noise and reference stability, tie REFCOMP to a 0.1 $\mu$ F capacitor to GND. Tying REFCOMP to GND causes the device to power up with the internal reference disabled, allowing the use of an external reference at startup.
36	$V_{CC}$	Analog Supply Voltage Input. $4.75 \text{ V} \leq V_{CC} \leq 5.25 \text{ V}$ . Bypass $V_{CC}$ to GND with a 1 $\mu$ F capacitor.
38	$\overline{\text{FAULT}}$	Fault Indicator. $\overline{\text{FAULT}}$ is an open-drain, N channel output that pulls low when a fault condition occurs. A fault condition is detected when the junction temperature exceeds 160°C or when a SPI transaction error occurs. The $\overline{\text{FAULT}}$ pin is released on the next $\overline{\text{CS/LD}}$ rising edge. A pull-up resistor of $\geq 10 \text{ k}\Omega$ is recommended.
41	EPAD	Exposed Pad. Internally tied to analog negative supply ( $V^-$ ). The EPAD must be soldered to the PCB.

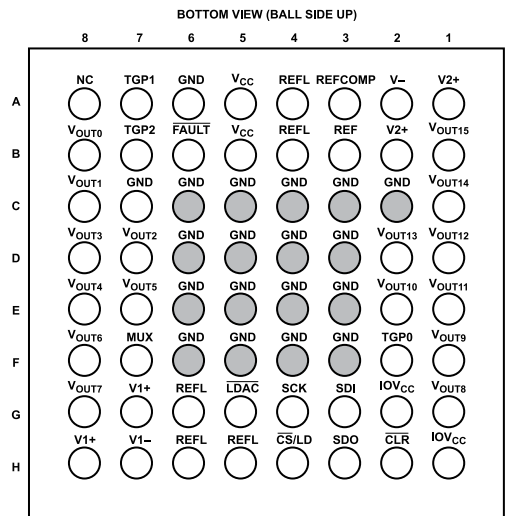

Figure 4. WLCSP Pin Configuration

Table 7. Pin Function Descriptions—WLCSP

Pin No.	Mnemonic	Description
A1, B2	$V2^+$	Analog Positive Supply for the $V_{OUT8}$ to $V_{OUT15}$ DAC Outputs. Bypass the $V2^+$ pin to GND with a 1 $\mu$ F capacitor. $V2^+$ must be less than or equal to $V1^+$ .
A2, H7	$V^-$	Analog Negative Supply. Bypass $V^-$ to GND with a 1 $\mu$ F capacitor unless $V^-$ is connected to GND.
A3	REFCOMP	Internal Reference Compensation. For low noise and reference stability, tie REFCOMP to a 0.1 $\mu$ F capacitor to GND. Tying REFCOMP to GND causes the device to power up with the internal reference disabled, allowing the use of an external reference at startup.
A4, B4, G6, H5, H6	REFL	Reference Low Pins. Signal ground for all DAC channels and internal reference. Tie the REFL pins to a clean analog ground plane.
A5, B5	$V_{CC}$	Analog Supply Voltage Input. $4.75 \text{ V} \leq V_{CC} \leq 5.25 \text{ V}$ . Bypass $V_{CC}$ to GND with a 1 $\mu$ F capacitor.
A6, C2, C3, C4, C5, C6, C7, D3, D4, D5, D6, E3, E4, E5, E6, F3, F4, F5, F6	GND	Analog Ground. Tie GND to a clean analog ground plane.
A7, B7, F2	TGP0, TGP1, TGP2	Asynchronous Toggle and Sinusoidal Dither Multifunctional Pins. In toggle mode, a falling edge updates the DAC register with data from Input Register A and a rising edge updates the DAC register with data from Input Register B. In sinusoidal dither mode, the toggle pins function as dither clock inputs. DAC outputs update on the rising edge. Toggle and dither operations only affect those DAC channels with their toggle/dither enable bit (ENX) set to 1. When neither toggle nor dither operations are used, tie the TGPx pins to GND, and set EN to 0. Logic levels are determined by IOVCC.
A8	NC	
B8, C8, D7, D8, E8, E7, F8, G8, G1, F1,	$V_{OUT0}$ to $V_{OUT15}$	DAC Analog Voltage Outputs.

## PIN CONFIGURATION AND FUNCTION DESCRIPTIONS

Table 7. Pin Function Descriptions—WLCSP (Continued)

Pin No.	Mnemonic	Description
E2, E1, D1, D2, C1, B1 B3	REF	Reference Input/Output. The voltage at the REF pin sets the full-scale range of all channels. By default, the internal reference is routed to this pin. The REF pin must be buffered when driving external dc load currents. When set to external reference mode, the internal reference is disconnected, and the REF pin becomes a high impedance input to which a precision external reference can be applied. For low noise and reference stability, tie a capacitor from the REF pin to GND. The value must be less than the capacitance at the REFCOMP pin. In external reference mode, the allowable reference input voltage range is 2.0 V to $V_{CC} - 0.6$ V.
B6	$\overline{\text{FAULT}}$	Fault Indicator. $\overline{\text{FAULT}}$ is an open-drain, N channel output that pulls low when a fault condition occurs. A fault condition is detected when the junction temperature exceeds 160°C or when a SPI transaction error occurs. The $\overline{\text{FAULT}}$ pin is released on the next $\overline{\text{CS/LD}}$ rising edge. A pull-up resistor of $\geq 10$ k $\Omega$ is recommended.
F7	MUX	Analog Multiplexer Output. Any of the 16 DAC output pin voltages, current load sense voltages ( $V_{\text{SENSE}}$ ), and junction temperatures can be monitored by measuring the voltage at the MUX pin. When the mux is disabled, the MUX pin becomes high impedance. A full listing of available mux functions is given in Table 26.
G7, H8	V1 <sup>+</sup>	Analog Positive Supply for the $V_{\text{OUT0}}$ to $V_{\text{OUT7}}$ DAC Outputs. Bypass V1 <sup>+</sup> to GND with a 1 $\mu$ F capacitor. V1 <sup>+</sup> must be greater than or equal to V2 <sup>+</sup> .
G2, H1	IOV <sub>CC</sub>	Digital Input/Output Supply Voltage. $1.71 \text{ V} \leq \text{IOV}_{\text{CC}} \leq V_{\text{CC}} + 0.3 \text{ V}$ . Bypass IOV <sub>CC</sub> to GND with a 0.1 $\mu$ F capacitor.
G3	SDI	Serial Interface Data Input. Data on SDI is clocked into the DAC on the rising edge of SCK. The LTC2688 accepts input word lengths of 24 bits or 32 bits. Logic levels are determined by IOV <sub>CC</sub> .
G4	SCK	Serial Interface Clock Input. Logic levels are determined by IOV <sub>CC</sub> .
G5	$\overline{\text{LDAC}}$	Active Low Asynchronous DAC Update Pin. When $\overline{\text{CS/LD}}$ is high, a falling edge on $\overline{\text{LDAC}}$ updates all DAC registers with the contents of the input registers. When $\overline{\text{LDAC}}$ is low, a rising edge on $\overline{\text{CS/LD}}$ similarly updates all DAC registers. Logic levels are determined by IOV <sub>CC</sub> . If the $\overline{\text{LDAC}}$ pin is not used, tie it high to IOV <sub>CC</sub> . Updates can then be performed through SPI commands.
H2	$\overline{\text{CLR}}$	Active Low Asynchronous Clear Input. A logic low at this level triggered input clears the device to zero-scale code and a 0 V to 5 V span range. The control registers are cleared to default values. Logic levels are determined by IOV <sub>CC</sub> .
H3	SDO	Serial Interface Data Output. Data is clocked out onto SDO by the falling edge of SCK. SDO is high impedance when $\overline{\text{CS/LD}}$ is high. Logic levels are determined by IOV <sub>CC</sub> .
H4	$\overline{\text{CS/LD}}$	Serial Interface Chip Select/Load Input. When $\overline{\text{CS/LD}}$ is low, SCK is enabled for shifting data on SDI into the register. When $\overline{\text{CS/LD}}$ is taken high, SCK is disabled and the specified command (see Table 8 and Table 9) is executed. Logic levels are determined by IOV <sub>CC</sub> .

TYPICAL PERFORMANCE CHARACTERISTICS

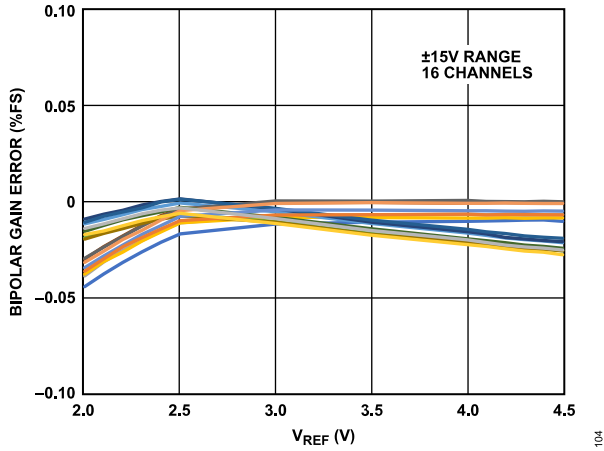

Figure 5. Bipolar Gain Error vs.  $V_{REF}$

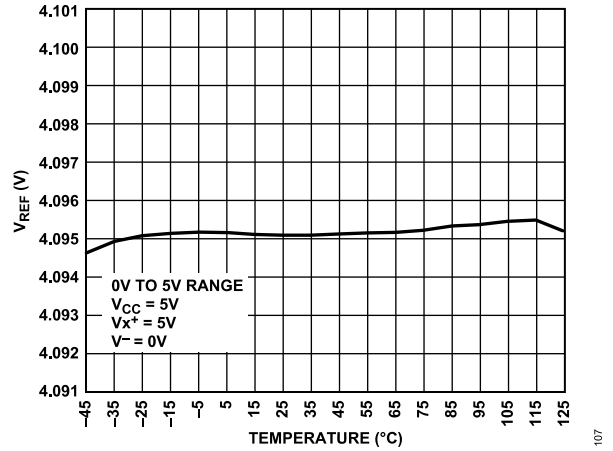

Figure 8.  $V_{REF}$  vs. Temperature

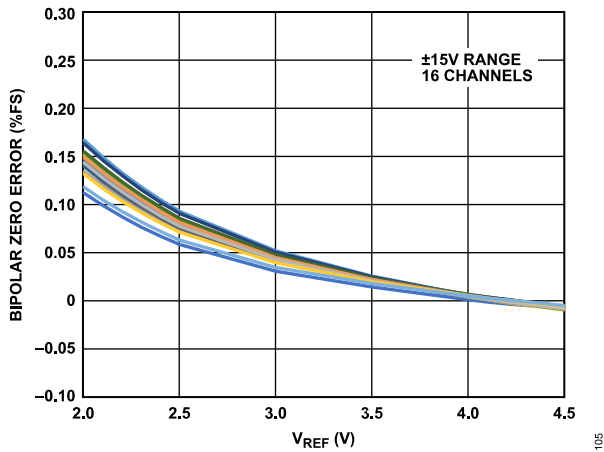

Figure 6. Bipolar Zero Error vs.  $V_{REF}$

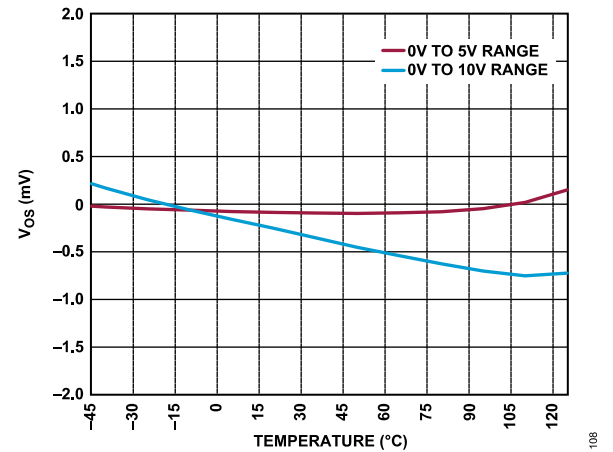

Figure 9. Unipolar Offset Error ( $V_{OS}$ ) vs. Temperature

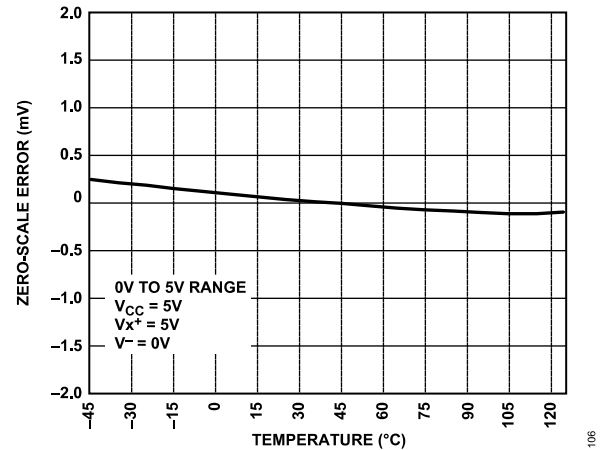

Figure 7. Zero-Scale Error (ZSE) vs. Temperature

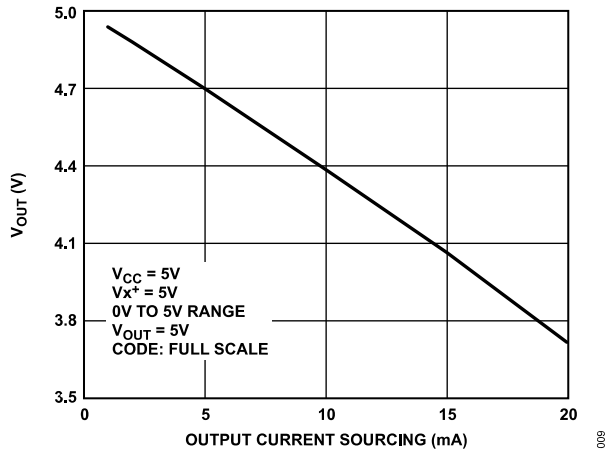

Figure 10.  $V_{OUT}$  vs. Output Current Sourcing

TYPICAL PERFORMANCE CHARACTERISTICS

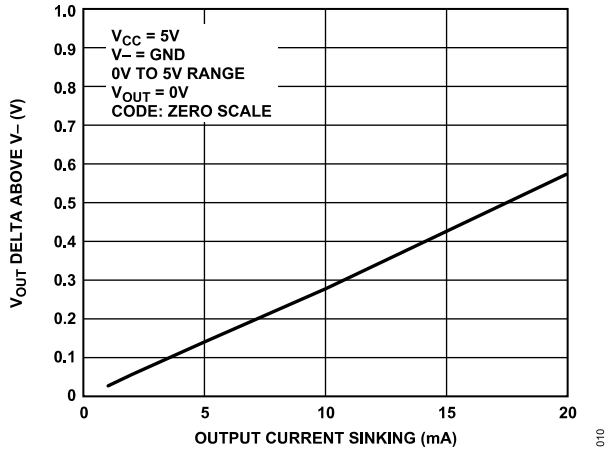

Figure 11.  $V_{OUT}$  Delta Above  $V^-$  vs. Output Current Sinking

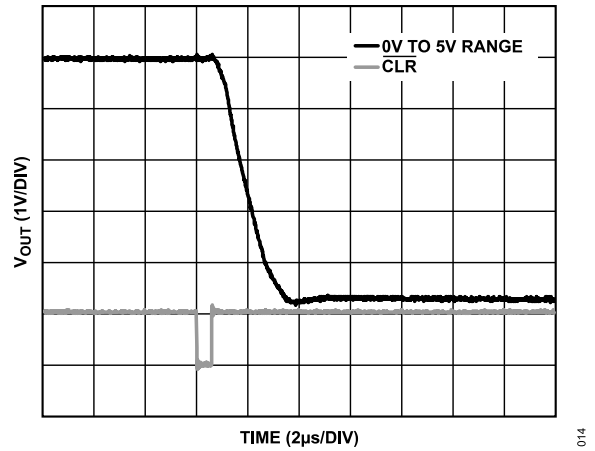

Figure 14. Hardware  $\overline{CLR}$  to Zero Scale

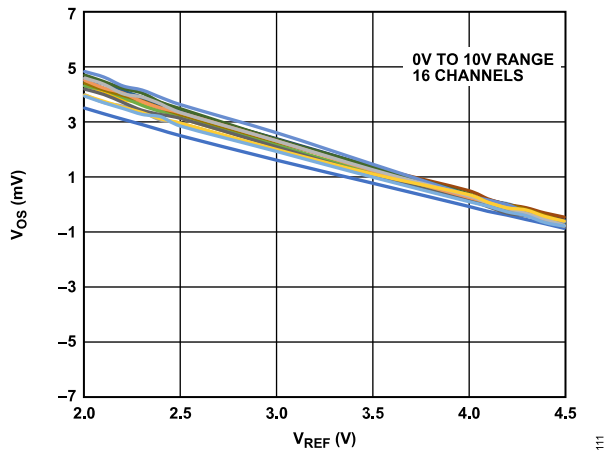

Figure 12.  $V_{OS}$  vs.  $V_{REF}$

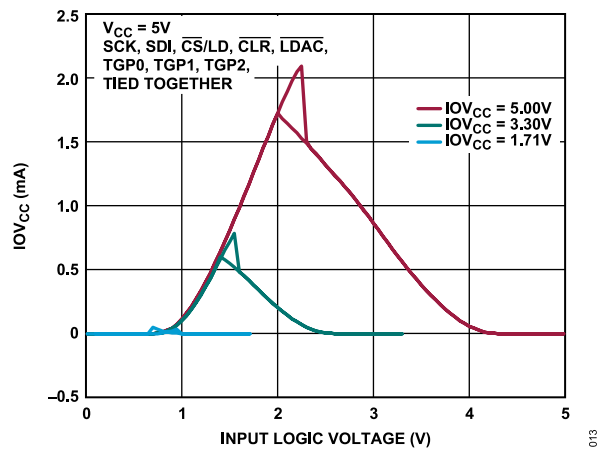

Figure 15.  $IOV_{CC}$  vs. Input Logic Voltage

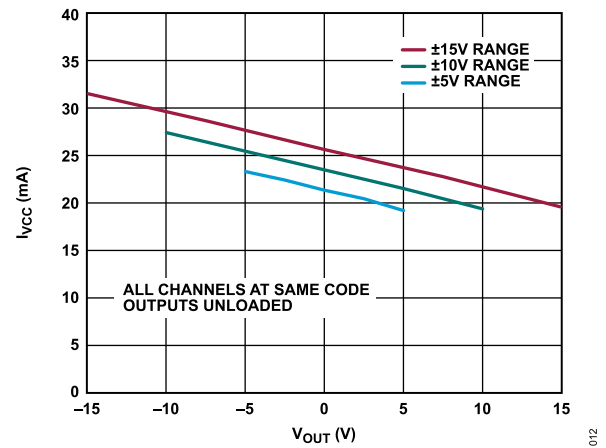

Figure 13.  $I_{VCC}$  vs.  $V_{OUT}$

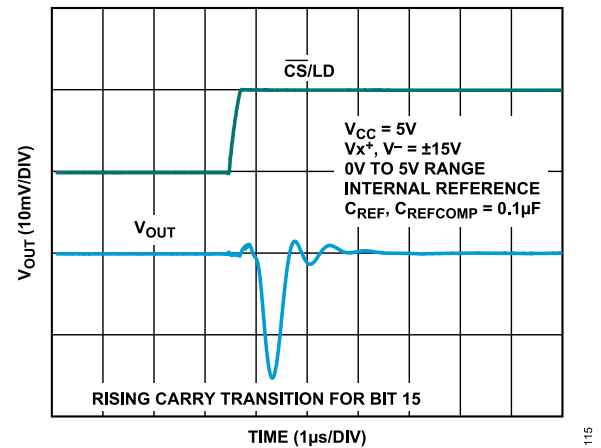

Figure 16. Glitch Impulse

TYPICAL PERFORMANCE CHARACTERISTICS

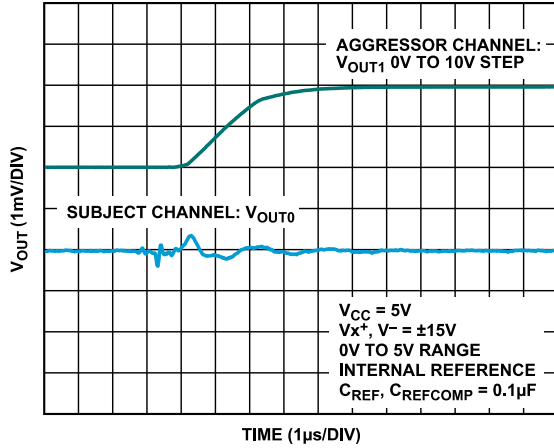

Figure 17. DAC to DAC Crosstalk

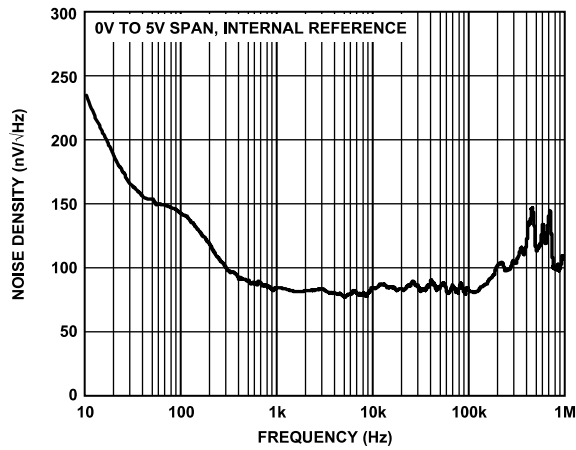

Figure 18. Noise Density vs. Frequency

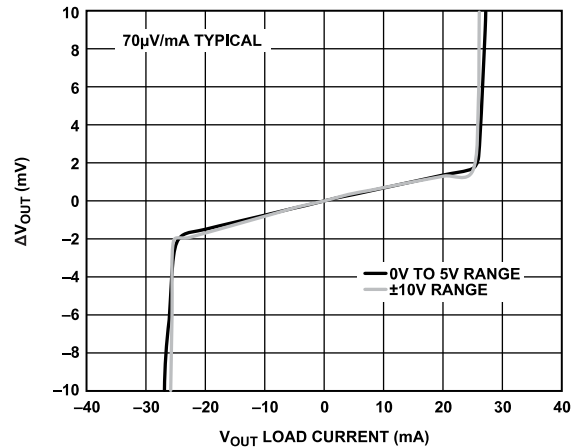

Figure 19.  $\Delta V_{OUT}$  vs.  $V_{OUT}$  Load Current

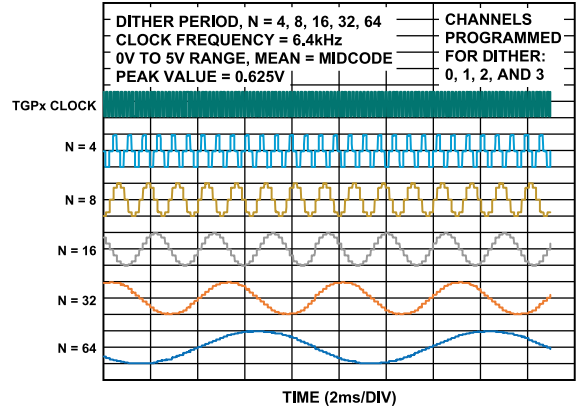

Figure 20. Sinusoidal Dither Waveform

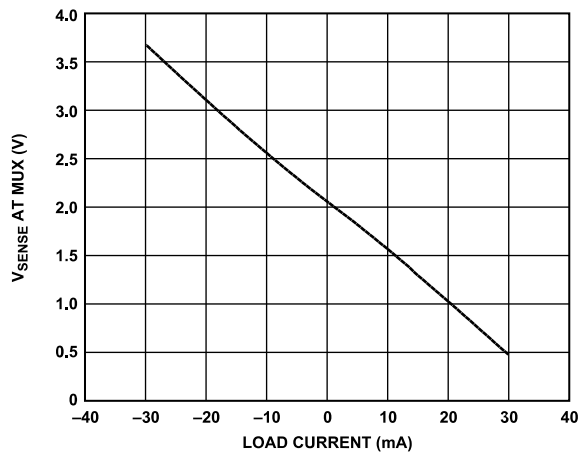

Figure 21.  $V_{SENSE}$  at MUX vs. Load Current

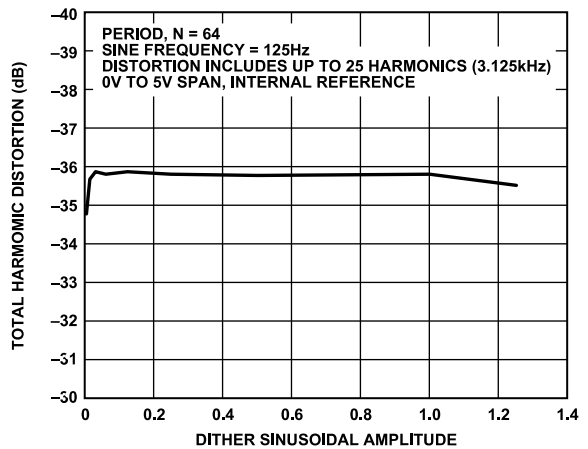

Figure 22. Total Harmonic Distortion (THD) vs. Dither Sinusoidal Amplitude

TYPICAL PERFORMANCE CHARACTERISTICS

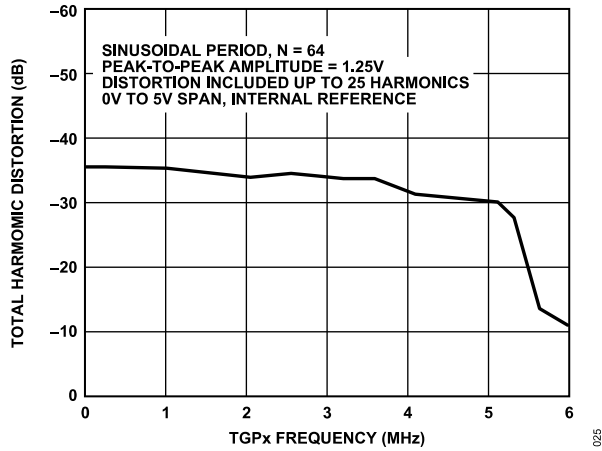

Figure 23. Total Harmonic Distortion vs. TGPx Frequency

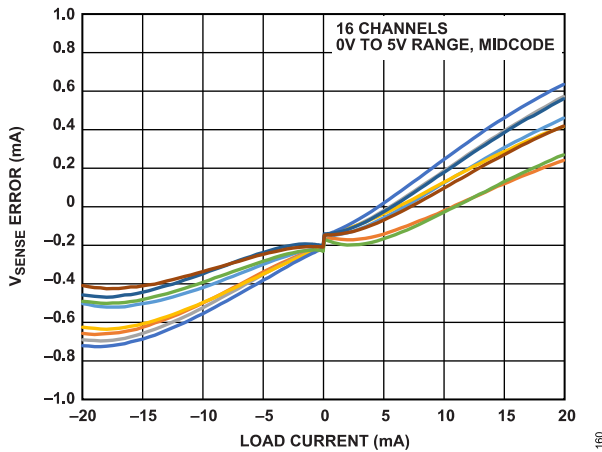

Figure 24.  $V_{SENSE}$  Error vs. Load Current from Equation 2 and Equation 3

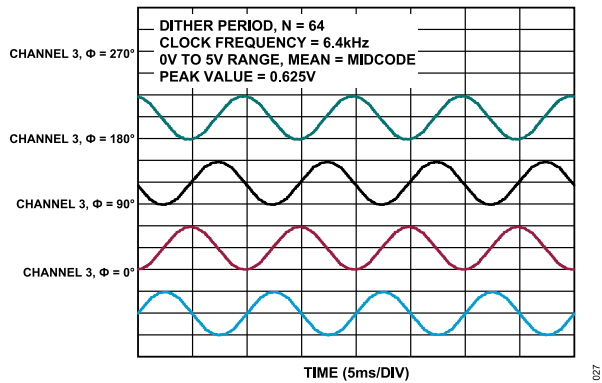

Figure 25. Sinusoidal Dither for Various Phase Settings

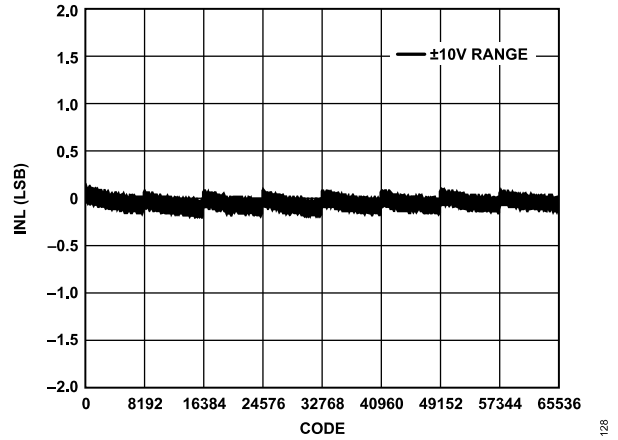

Figure 26. LTC2688-16 INL vs. Code

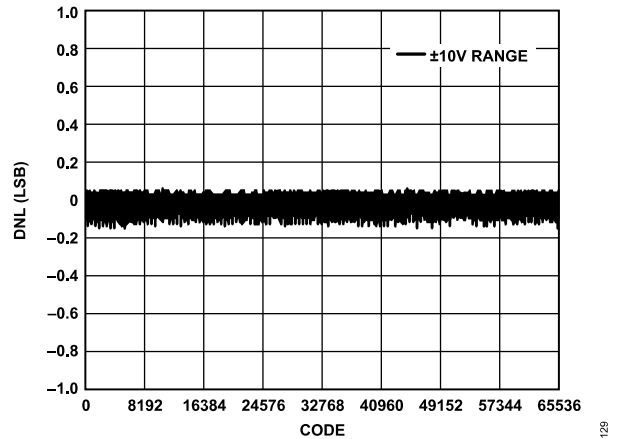

Figure 27. LTC2688-16 DNL vs. Code

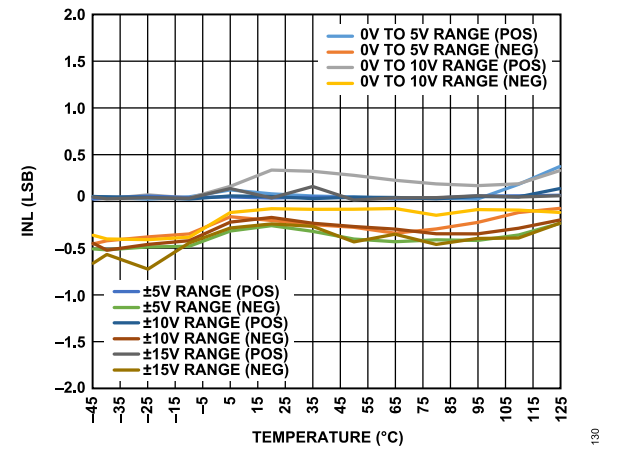

Figure 28. LTC2688-16 INL vs. Temperature

TYPICAL PERFORMANCE CHARACTERISTICS

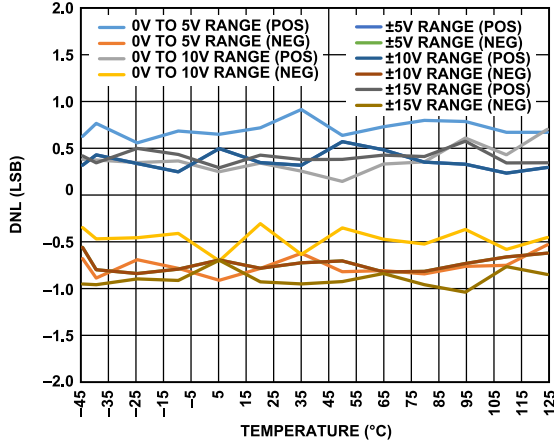

Figure 29. LTC2688-16 DNL vs. Temperature

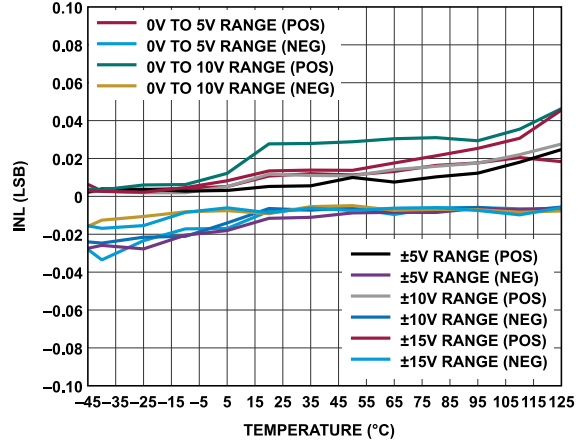

Figure 32. LTC2688-12 INL vs. Temperature

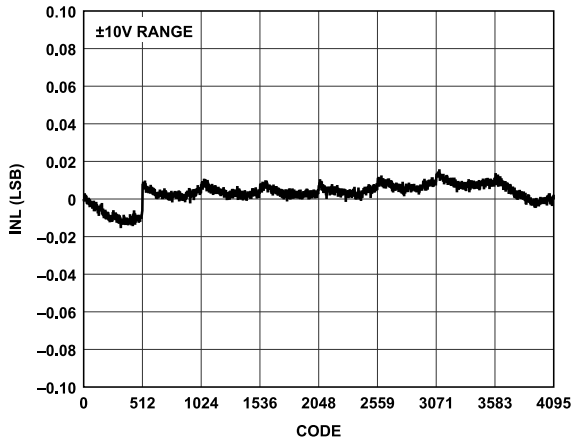

Figure 30. LTC2688-12 INL vs. Code

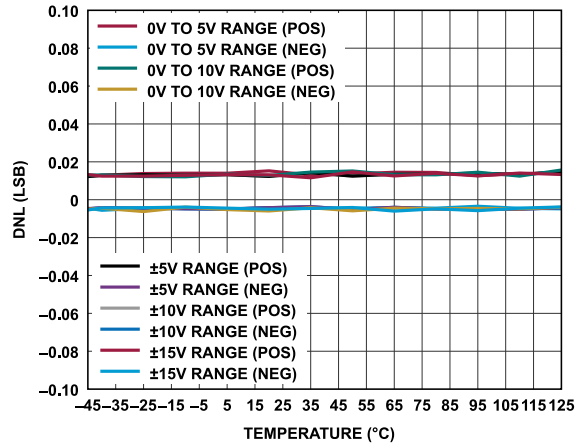

Figure 33. LTC2688-12 DNL vs. Temperature

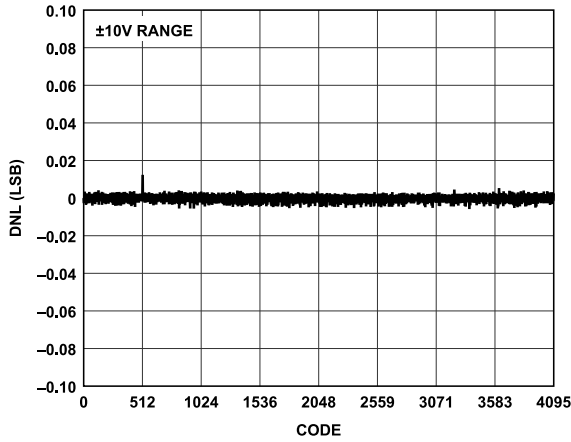

Figure 31. LTC2688-12 DNL vs. Code

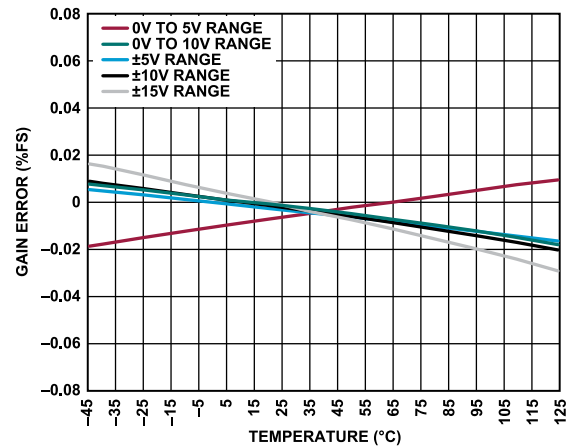

Figure 34. Gain Error vs. Temperature

TYPICAL PERFORMANCE CHARACTERISTICS

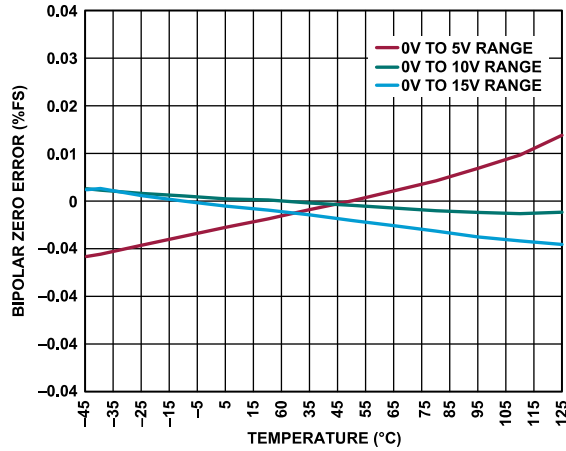

Figure 35. Bipolar Zero Error vs. Temperature

145

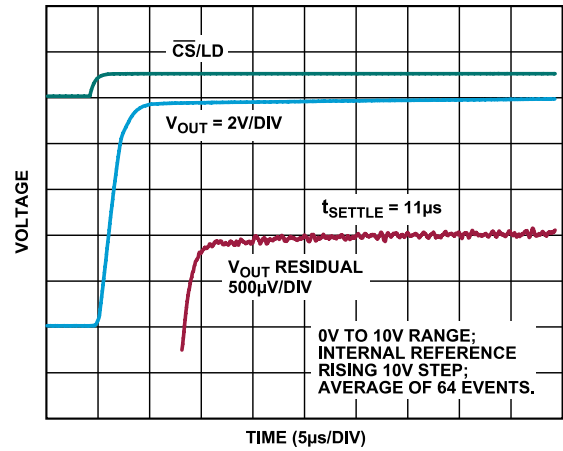

Figure 38. Settling Time, 10 V

135

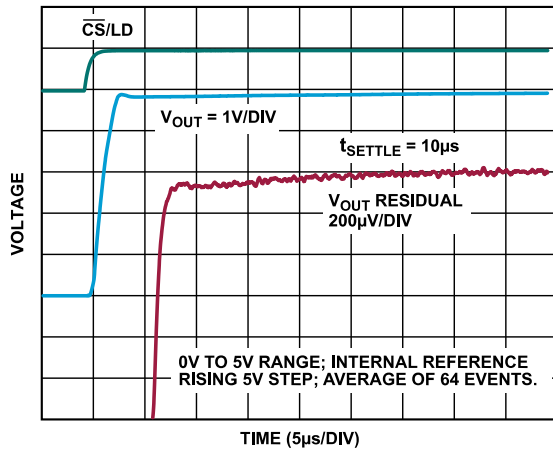

Figure 36. Settling Time, 5 V

134

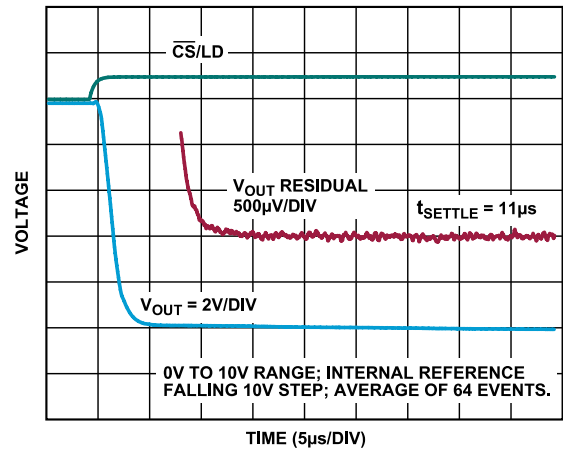

Figure 39. Settling Time, 10 V (Falling)

139

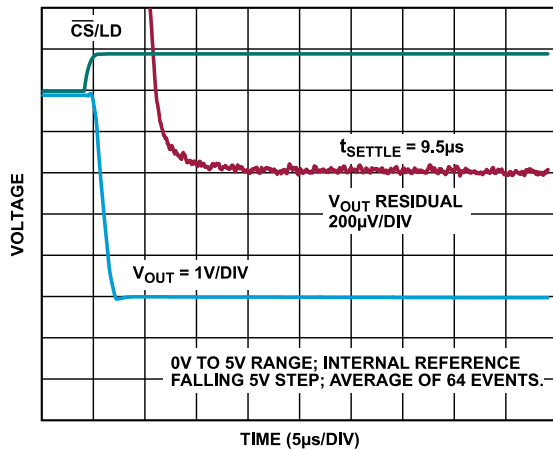

Figure 37. Settling Time, 5 V (Falling)

138

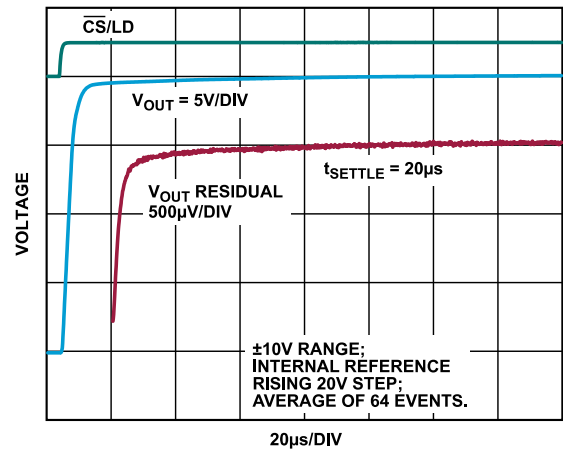

Figure 40. Settling Time, 20 V

136

TYPICAL PERFORMANCE CHARACTERISTICS

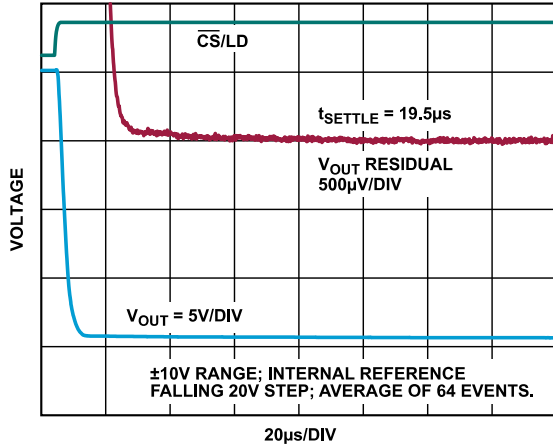

Figure 41. Settling Time, 20 V (Falling)

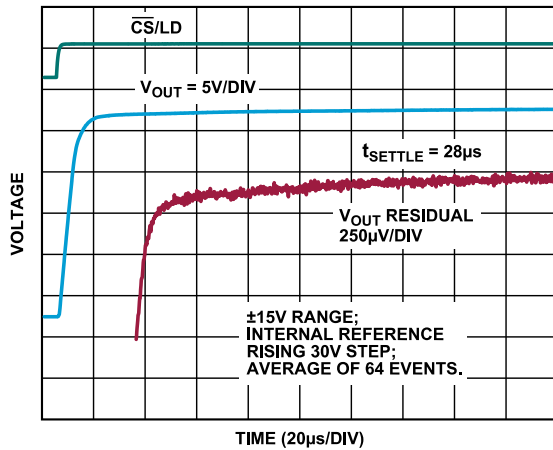

Figure 42. Settling Time, 30 V

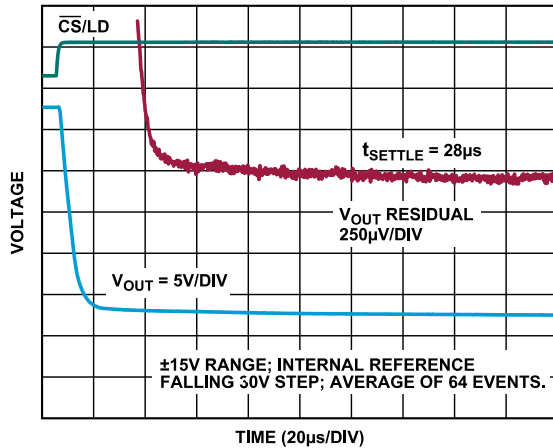

Figure 43. Settling Time, 30 V (Falling)

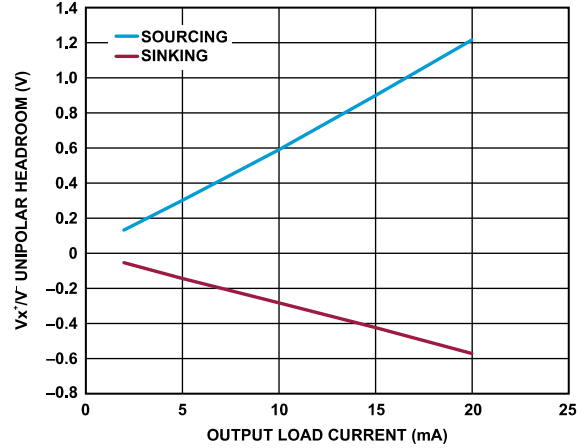

Figure 44.  $V_{x^+}/V^-$  Unipolar Headroom vs. Output Load Current

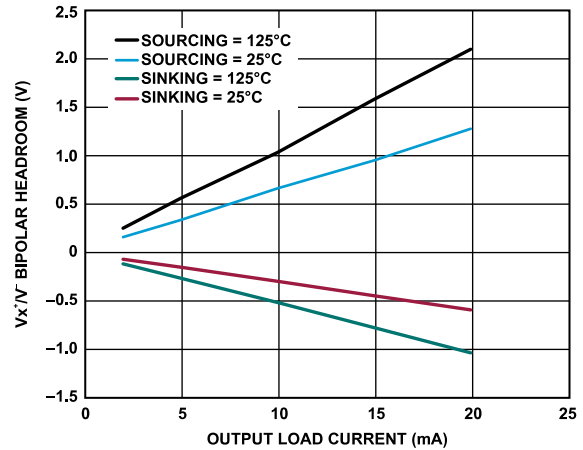

Figure 45.  $V_{x^+}/V^-$  Bipolar Headroom vs. Output Load Current

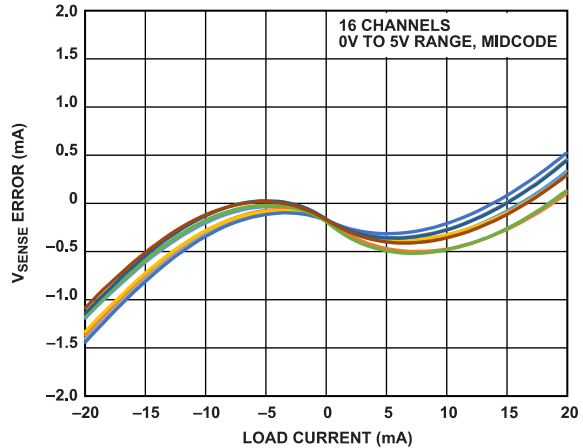

Figure 46.  $V_{SENSE}$  Error vs. Load Current from Equation 5

## TERMINOLOGY

### Integral Nonlinearity (INL)

Integral nonlinearity is a measurement of the maximum deviation, in LSBs, from a straight line passing through the endpoints of the DAC transfer function. A typical INL error vs. DAC code plot is shown in [Figure 26](#).

### Differential Nonlinearity (DNL)

Differential nonlinearity is the difference between the measured change and the ideal 1 LSB change between any two adjacent codes. A specified differential nonlinearity of  $\pm 1$  LSB maximum ensures monotonicity. This DAC is guaranteed monotonic by design. A typical DNL error vs. DAC code plot is shown in [Figure 27](#).

### Unipolar Offset Error ( $V_{OS}$ )

Unipolar offset error is the voltage that is measured when zero code is loaded to the DAC register, for unipolar output voltage ranges. Unipolar offset error is expressed in mV.

### $V_{OS}$ Temperature Coefficient

$V_{OS}$  temperature coefficient is a measure of the change in  $V_{OS}$  with a change in temperature. It is expressed in ppm/ $^{\circ}$ C.

### Single-Supply Zero-Scale Error

Single-supply zero-scale error is a measurement of the output error when zero code is loaded to the DAC register, and the device is operated with a single supply and  $V^-$  is grounded.

### Bipolar Zero Error (BZE)

Bipolar zero error is the deviation of the analog output from the ideal midscale output of 0 V when the DAC register is loaded with midscale code.

### Bipolar Zero Error Temperature Coefficient

Bipolar zero error temperature coefficient is a measure of the change in BZE with a change in temperature. It is expressed in ppm/ $^{\circ}$ C.

### Gain Error

Gain error is a measure of the span error of the DAC. It is the deviation in slope of the DAC transfer characteristic from the ideal expressed as %FSR.

### Gain Error Temperature Coefficient

Gain temperature coefficient is a measurement of the change in gain error with changes in temperature. It is expressed in ppm of ppm/ $^{\circ}$ C.

### Power Supply Rejection (PSR)

PSR indicates how the output of the DAC is affected by changes in the supply voltage. PSR is the ratio of the change in  $V_{OUTX}$  to a change in  $V_{CC}$  for a full-scale output of the DAC. It is measured in dB.

### Settling Time

Settling time is the amount of time it takes for the output of a DAC to settle to a specified level for a  $\frac{1}{4}$  to  $\frac{3}{4}$  full-scale input change and is measured from the rising edge of  $\overline{CS}/LD$ .

### Glitch Impulse

Glitch impulse is the impulse injected into the analog output when the input code in the DAC register changes state. It is normally specified as the area of the glitch in nV-sec, and is measured when the digital input code is changed by 1 LSB at the midscale transition.

### DC Crosstalk

DC crosstalk is the dc change in the output level of one DAC in response to a change in the output or power status of another DAC. It is measured with a full-scale output change on one DAC (or power-down and power-up) while monitoring another DAC output maintained at midscale. It is expressed in  $\mu$ V.

DC crosstalk due to load current change is a measure of the impact that a change in load current on one DAC has to another DAC kept at midscale. It is expressed in  $\mu$ V/mA.

### DAC to DAC Crosstalk

DAC to DAC crosstalk is the glitch impulse transferred to the output of one DAC due to a digital code change and subsequent analog output change of another DAC. DAC to DAC crosstalk is measured with a full-scale code change (all 0s to all 1s and vice versa) on one DAC output, using the write and update commands, while monitoring the other DAC output kept at midscale. The energy of the glitch is expressed in nV-sec.

### Output Noise Spectral Density

Output noise spectral density is a measurement of the internally generated random noise. Random noise is characterized as a spectral density (nV/ $\sqrt{\text{Hz}}$ ). It is measured by loading the DAC to midscale and measuring noise at the output. It is measured in nV/ $\sqrt{\text{Hz}}$ .

## THEORY OF OPERATION

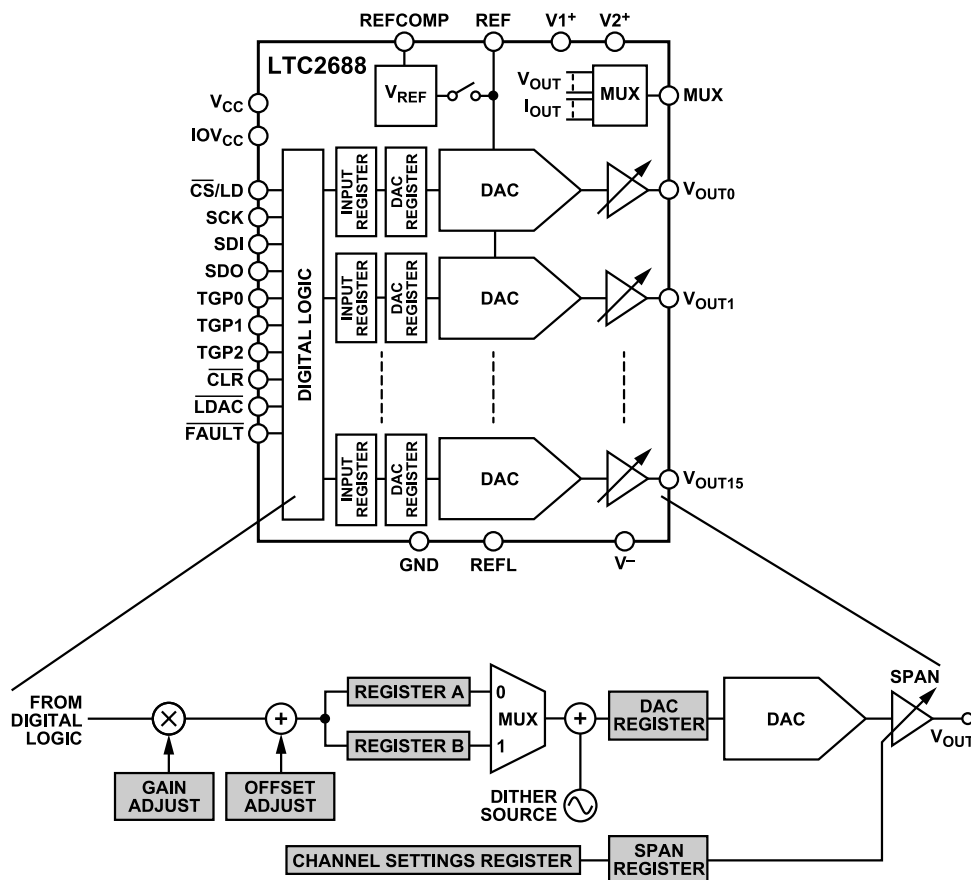

Figure 47. Block Diagram

The LTC2688 is a 16-channel,  $\pm 15$  V DAC with selectable output ranges and an integrated precision reference. The DAC operates on a positive 5 V  $V_{CC}$  supply, and the outputs are driven by bipolar supply rails ( $V1^+$ ,  $V2^+$ , and  $V^-$ ).  $V1^+$  and  $V2^+$  can operate as low as  $V_{CC}$ , and the negative  $V^-$  supply can operate at ground, making the devices compatible with single-supply systems.  $V1^+$  and  $V2^+$  can operate as high as +21 V ( $V1^+$  must be greater than or equal to  $V2^+$ ).  $V^-$  can operate as low as -21 V, making the LTC2688 robust in industrial environments where high voltage fault protection is critical.

The output amplifiers offer true rail-to-rail operation and can source or sink up to 20 mA per DAC channel. The  $V1^+$  and  $V2^+$  pins can operate at independent voltages to optimize power efficiency. When drawing a load current from the  $V1^+$ ,  $V2^+$ , or  $V^-$  rails, the output voltage headroom with respect to that rail is limited by the typical channel resistance of the output devices.

### POWER-ON RESET

The outputs reset when power is first applied, making system initialization consistent and repeatable. Furthermore, on power-up, the device resets all internal registers to their default values. The default output range for all DAC channel outputs is 0 V to 5 V, and the default DAC code is zero scale.

### POWER SUPPLY SEQUENCING

To minimize channel output overshoot and any excess current during power-up, power up the supplies as follows. If  $V_{CC}$  and  $Vx^+$  have the same values, tie  $Vx^+$  to  $V_{CC}$  and power them up first, and then power up  $V^-$ . If  $V_{CC}$  and  $Vx^+$  have different values, power up  $Vx^+$ , then  $V_{CC}$ , and finally  $V^-$ .  $IOV_{CC}$  does not have a supply sequence requirement. For both scenarios, it is recommended to keep the supply ramp times for all supplies to 100  $\mu$ s or slower. If an external reference is used, maintain the voltage at REF within the range of  $-0.3 \text{ V} \leq V_{REF} \leq V_{CC} + 0.3 \text{ V}$  during power-up (see the [Absolute Maximum Ratings](#) section) and tie the REFCOMP pin to ground (see the [Reference Modes](#) section). Take particular care to observe these limits during power supply turn on and turn off sequences when the voltage at  $V_{CC}$  is in transition. On power-up, immediately perform a software reset.

Supply bypassing is critical to achieving optimal performance. For optimal performance, establish at least 1  $\mu$ F to ground on the  $V_{CC}$ ,  $V^+$ , and  $V^-$  supplies, and establish at least 0.1  $\mu$ F of low, 100 m $\Omega$ , effective series resistance (ESR) capacitance for each supply, as close to the device as possible. The larger capacitor can be omitted for  $IOV_{CC}$ .

037

THEORY OF OPERATION

SERIAL INTERFACE

When the  $\overline{CS}/LD$  pin is taken low, the data on the SDI pin is loaded into the shift register on the rising edges of the clock (SCK). Data can only be transferred to the LTC2688 when the  $\overline{CS}/LD$  signal is low. The rising edge of  $\overline{CS}/LD$  ends the data transfer and causes the device to carry out the action specified. For the LTC2688, the total word length can be 24 bits (3 bytes) or 32 bits (4 bytes). The leading command/address byte is followed by two data bytes and an optional third that contains an optional 6-bit cyclic redundancy check (CRC) code. See the [SPI Cyclic Redundant Check Enable/Disable](#) section for details.

CRC checking is only supported for a word length of 32 bits (4 bytes). In daisy-chain mode, internal register length requires the clock count to be multiples of 32. See the [Daisy-Chain Mode](#) section for details.

To ensure data integrity, the device also monitors the number of bits clocked into the chip and issues a fault condition for an invalid number of clock cycles. See the [Fault Detection](#) section for details.

Figure 48 and Figure 49 show timing waveforms of a typical 32-bit SPI transaction. The  $\overline{CS}/LD$  pin must be low while bits are

clocked in. The following rising edge of  $\overline{CS}/LD$  completes the SPI transaction and executes the command. Figure 48 shows a typical 32-bit write command sequence with echo readback. For all write commands, the command word reappears on the SDO pin with a latency of one command cycle (echo readback). This latency allows the user to read back the command from the device and verify the integrity of the data transfer. Figure 49 shows a typical 32-bit read command sequence. In this example, the user reads the fault register. Both the read command and the requested data appear with a latency of one command cycle during the transmission of the next command word.

Figure 50 shows a typical 24-bit read command sequence. A 24-bit read command differs from a 32-bit read command in that only the requested data appears with a latency of one command cycle during the transmission of the next command word. The first eight bits do not show the read command that was executed. Instead, ignore those bits. Note that echo readback is not available when 24-bit command words are used.

For the detailed structure of command words, refer to the [Writing Codes to DACs](#) section and the [Read Commands](#) section.

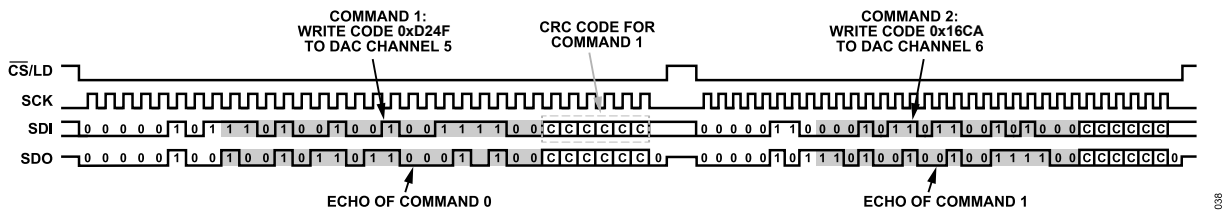

Figure 48. Typical Write Command Sequence for 32-Bit Words, with Echo Readback

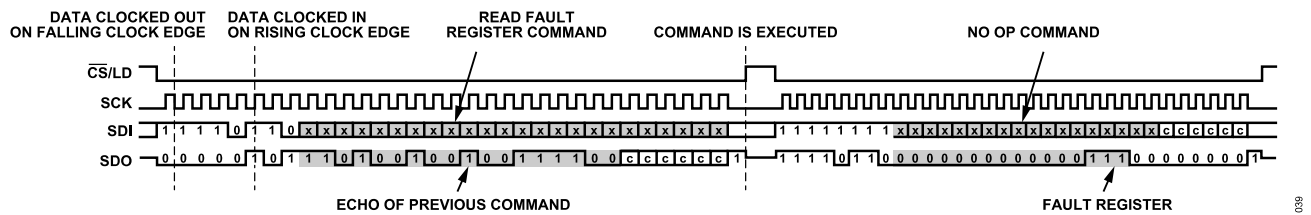

Figure 49. Typical Read Command Sequence for 32-Bit Words, X = Don't Care

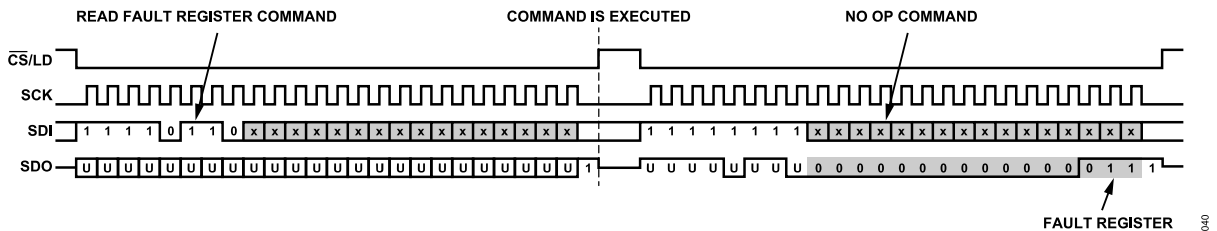

Figure 50. Typical Read Command Sequence for 24-Bit Words

## THEORY OF OPERATION

## SPI Command Table

The LTC2688 supports the write and read commands summarized in [Table 8](#) and [Table 9](#). Commands are encoded with the first byte containing the command code. For commands that refer to a specific DAC channel, the chip interprets the last four bits of the command byte as the binary encoded DAC Channel Address

A[3:0], see [Table 10](#). The optional CRC error checking is available for all commands, except for the write/read configuration register (Command 7 and Command 24), and the write/read fault register (Command 13 and Command 30). For these commands, CRC error checking is skipped even if the CRC error checking feature is enabled.

Table 8. Write Operation SPI Commands

Command No.	Write Operations	Command Code	Data	CRC (Optional)
0	Write code to DAC Channel x	0000 A[3:0]	Data	CRC
1	Write channel settings to DAC Channel x	0001 A[3:0]	Data	CRC
2	Write offset adjust to DAC Channel x	0010 A[3:0]	Data	CRC
3	Write gain adjust to DAC Channel x	0011 A[3:0]	Data	CRC
4	Write code to and update DAC Channel x	0100 A[3:0]	Data	CRC
5	Write code to DAC Channel x, update all DAC channels	0101 A[3:0]	Data	CRC
6	Update DAC Channel x	0110 A[3:0]	Don't care	CRC
7	Write configuration register	0111 0000	Data	Don't care
8	Write power-down register	0111 0001	Data	CRC
9	Write A/B select register	0111 0010	Data	CRC
10	Write software toggle bit register	0111 0011	Data	CRC
11	Write toggle/dither enable register	0111 0100	Data	CRC
12	Write mux control register	0111 0101	Data	CRC
13	Write fault register	0111 0110	Data	Don't care
14	Write code to all DAC channels	0111 1000	Data	CRC
15	Write code and update all DAC channels	0111 1001	Data	CRC
16	Write channel settings to all DAC channels	0111 1010	Data	CRC
17	Write channel settings and update all DAC channels	0111 1011	Data	CRC
18	Update all DAC channels	0111 1100	Don't care	CRC

Table 9. Read Operation SPI Commands

Command No.	Read Operations	Command Code	Data	CRC (Optional)
20	Read offset and gain adjusted code of DAC Channel x	1000 A[3:0]	Don't care	CRC
21	Read channel settings of DAC Channel x	1001 A[3:0]	Don't care	CRC
22	Read offset adjust of DAC Channel x	1010 A[3:0]	Don't care	CRC
23	Read gain adjust of DAC Channel x	1011 A[3:0]	Don't care	CRC
24	Read configuration register	1111 0000	Don't care	Don't care
25	Read power-down status	1111 0001	Don't care	CRC
26	Read A/B select register	1111 0010	Don't care	CRC
27	Read software toggle bit register	1111 0011	Don't care	CRC
28	Read toggle/dither enable register	1111 0100	Don't care	CRC
29	Read mux control register	1111 0101	Don't care	CRC
30	Read fault register	1111 0110	Don't care	Don't care
31	Read thermal shutdown status register	1111 0111	Don't care	CRC
32	No operation	1111 1111	Don't care	CRC

## THEORY OF OPERATION

## WRITING CODES TO DACS

The LTC2688 has several internal registers for each DAC. A DAC channel has two sets of double buffered registers: one set for the code data, and one set for the span (output range) of the DAC. Double buffering provides the capability to simultaneously update the span and code, which allows smooth voltage transitions when changing output ranges. Double buffering also enables the simultaneous updating of multiple DACs. Each set of double buffered registers comprises an input register and a DAC register, as follows:

- ▶ **Input register:** the write operation shifts data from the SDI pin into a chosen input register. The input registers are holding buffers. Write operations do not affect the DAC outputs directly. In the code datapath, there are two input registers, A and B, for each DAC register. Input Register B is an alternate input register used only in toggle and dither operation, whereas Input Register A is the default input register (see [Figure 47](#)).
- ▶ **DAC register:** the update operation copies the contents of an input register to its associated DAC register. The content of a DAC register directly controls the DAC output voltage or range. The update operation also powers up the selected DAC if it was in power-down mode. The datapath and registers are shown in [Figure 47](#). Updates always refresh both code and span data, but the values held in the DAC registers remain unchanged unless the associated input register values have been changed via a write operation. For example, writing a new code and updating the channel updates the code, but the span is unchanged. A channel update can come from a serial update command, an LDAC negative pulse, or a toggle operation.

[Table 12](#) shows the command word structure for Command 0, write code to DAC Channel x. Individual DAC channels are addressed by Bits A[3:0] as shown in [Table 10](#). The MSB bit of the data, D[15:0] is always aligned with the first bit of Byte 1.

**Table 11. Write Code to DAC Channel X, Command 0 (LTC2688-12)**

Command Code	Byte 1										Byte 2						Byte 3							
0000, A[3:0]	D11	D10	D9	D8	D7	D6	D5	D4	D3	D2	D1	D0	X	X	X	X	X	X	C/X	C/X	C/X	C/X	C/X	C/X

**Table 12. Write Code to DAC Channel X, Command 0 (LTC2688-16)**

Command Code	Byte 1										Byte 2						Byte 3							
0000, A[3:0]	D15	D14	D13	D12	D11	D10	D9	D8	D7	D6	D5	D4	D3	D2	D1	D0	X	X	C/X	C/X	C/X	C/X	C/X	C/X

**Table 13. Writing DAC Channel Settings, Command 1**

Command Code	Byte 1						Byte 2						Byte 3											
0001, A[3:0]	X	X	X	X	Mode	DIT_ PH1	DIT_ PH0	DIT_ PER2	DIT_ PER1	DIT_ PER0	TD_ SEL1	TD_ SEL0	S3	S2	S1	S0	X	X	C/X	C/X	C/X	C/X	C/X	C/X

**Table 10. DAC Address Mapping**

DAC No.	Address			
	A3	A2	A1	A0
DAC0	0	0	0	0
DAC1	0	0	0	1
DAC2	0	0	1	0
DAC3	0	0	1	1
DAC4	0	1	0	0
DAC5	0	1	0	1
DAC6	0	1	1	0
DAC7	1	1	1	1
DAC8	1	0	0	0
DAC9	1	0	0	1
DAC10	1	0	1	0
DAC11	1	0	1	1
DAC12	1	1	0	0
DAC13	1	1	0	1
DAC14	1	1	1	0
DAC15	1	1	1	1

Several additional commands are supported to write codes to DAC channels and perform update operations. Command 0, Command 4, and Command 5 write a DAC code to DAC Channel x, with x encoded in A[3:0]. In addition to writing a DAC code to DAC Channel x, Command 4 updates DAC Channel x and Command 5 updates all DAC channels. Command 6 only updates DAC Channel x.

Command 14, Command 15, and Command 18 operate on all DAC channels simultaneously. Command 14 writes the same code to all DAC channels, Command 15 writes to and updates all DAC channels, and Command 18 only updates all DAC channels.

All commands that write or update DAC channels follow the same command word structure as shown in [Table 12](#), except for Command 6 and Command 18, for which the D[15:0] data is replaced with X, where X represents don't care bits. Note that C represents the CRC code bits.

## THEORY OF OPERATION

## SPAN SELECTION AND CHANNEL SETTINGS

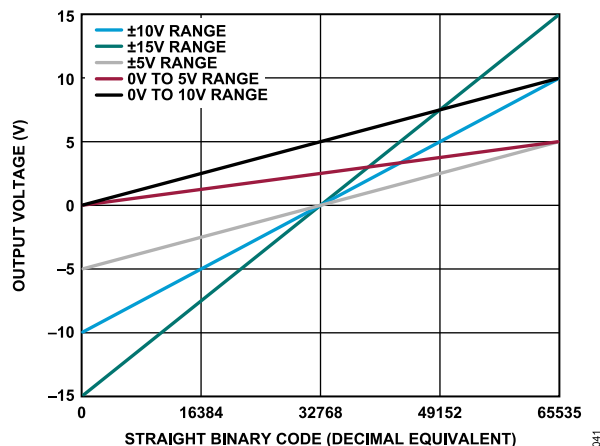

Figure 51. DAC Transfer Functions for LTC2688-16, All Voltage Spans and Bit Resolutions, Internal Reference Mode

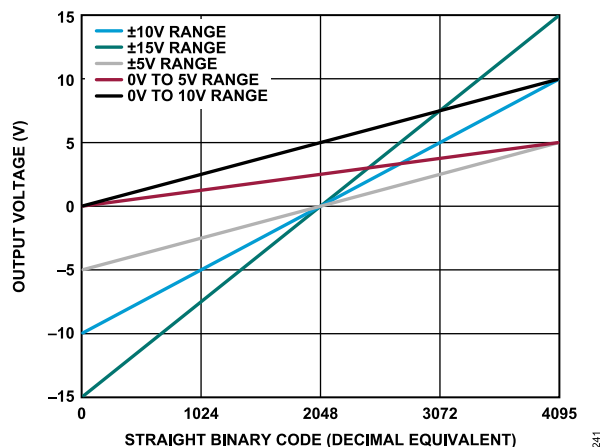

Figure 52. DAC Transfer Functions for LTC2688-12, All Voltage Spans and Bit Resolutions, Internal Reference Mode

The LTC2688 allows individual programming of the voltage span (output voltage range) for each DAC channel (SoftSpan). The device also supports 5% overrange spans. The span selection bits, S[3:0], encode span settings as summarized in Table 14 and Table 15, and the corresponding DAC transfer functions are depicted in Figure 51.

Table 14. Span Selection Bits S[3:0] Settings

S3	S2	S1	S0	Output Range	
				Internal Reference	External Reference
0	0	0	0	0 V to 5 V	0 V to $5 \times (V_{REF}/4.096)$
0	0	0	1	0 V to 10 V	0 V to $10 \times (V_{REF}/4.096)$
0	0	1	0	$\pm 5$ V	$\pm 5 \times (V_{REF}/4.096)$
0	0	1	1	$\pm 10$ V	$\pm 10 \times (V_{REF}/4.096)$
0	1	0	0	$\pm 15$ V	$\pm 15 \times (V_{REF}/4.096)$

Table 15. Span Selection Bits S[3:0] Settings, 5% Overage

S3	S2	S1	S0	Output Range	
				Internal Reference	External Reference
1	0	0	0	0 V to 5.25 V	0 V to $5 \times (V_{REF}/4.096)$
1	0	0	1	0 V to 10.5 V	0 V to $10 \times (V_{REF}/4.096)$
1	0	1	0	$\pm 5.25$ V	$\pm 5 \times (V_{REF}/4.096)$
1	0	1	1	$\pm 10.5$ V	$\pm 10 \times (V_{REF}/4.096)$
1	1	0	0	$\pm 15.75$ V	$\pm 15 \times (V_{REF}/4.096)$

Use Command 1, detailed in Table 13, to program DAC channel settings and span ranges. Span settings are contained in Bits S[3:0] and the default value is 0x0. Note that X represents the don't care bits and C represents the CRC code bits. If CRC error checking is not used, the third data byte can be omitted (24-bit word length). See the Toggle and Dither Operation section for a detailed description of related registers and functions.

Command 1 writes the settings of DAC Channel x, with DAC Channel Address x encoded in A[3:0]. Command 16 writes settings to all DAC channels, whereas Command 17 also updates all DAC channels.

## READ COMMANDS

Read operations are initiated with read commands as shown in Table 16. The command byte is followed by X (don't care bits), and an optional CRC code. For example, when reading the configuration register, the user must send Command 24 (see Table 16) to the device. The requested data appears at the SDO pin in the next command cycle (see Table 17) and mirrors the syntax of the corresponding write command. Note that the device outputs trailing zeros for the third byte. For a list of supported read commands, refer to Table 9.

## THEORY OF OPERATION

Table 16. Command Word for Reading Configuration Register, Command 24

Command Code	Byte 1										Byte 2						Byte 3									
1111 0000	X	X	X	X	X	X	X	X	X	X	X	X	X	X	X	X	X	X	X	X	C/X	C/X	C/X	C/X	C/X	C/X

Table 17. SDO Pin Data-Words After the Read Configuration Register Command

Command Code	Byte 1										Byte 2			Byte 3									
1111 0000	RST	0	0	0	0	0	0	0	0	0	0	0	0	TSD_ DIS	EXT_ REF	SPI_ CRC	0	0	0	0	0	0	0

## THEORY OF OPERATION

## OFFSET AND GAIN ADJUSTMENT

The LTC2688 supports offset and gain adjustment for each individual DAC channel. Note that the gain operation is performed before the offset correction (see Figure 47). The adjusted DAC code is calculated by multiplying the code data, D[15:0], by the gain adjust code, G[15:0], and then adding the offset adjust code, O[13:0].

## Offset Adjustment

The device supports an offset adjustment range of  $\pm 12.5\%$  full scale with a resolution of 1 LSB. Table 18 shows offset adjustment ranges and corresponding codes. Note that negative offsets are encoded in twos complement binary data format.

Use Command 2 (see Table 19) to program offset adjustments. Note that after writing to the offset adjustment registers of a DAC channel, offset adjustment does not take effect until a code is written to the DAC. Use Command 20 to read back the

offset adjusted DAC code. Table 20 shows the adjusted data-word that appears at the SDO pin after Command 20 is written.

Table 18. Offset Correction Range and Codes

Offset Adjust Value <sup>1</sup>	O[13:0] <sup>1</sup>
+12.498 % FS	0111...111
...	...
+30.5 ppm FS	0000...010
+15.3 ppm FS	0000...001
0 ppm FS	0000...000
-15.3 ppm FS	1111...111
-30.5 ppm FS	1111...110
...	...
-12.5 % FS	1000...000

<sup>1</sup> Ellipses (...) indicate a sequential continuation of the numbering scheme.

Table 19. Writing Offset Adjustment to a DAC Channel, Command 2

Command Code	Byte 1								Byte 2								Byte 3							
0010 A[3:0]	O13	O12	O11	O10	O9	O8	O7	O6	O5	O4	O3	O2	O1	O0	X	X	X	X	C/X	C/X	C/X	C/X	C/X	C/X

Table 20. SDO Pin Data-Word Readback of Offset and Gain Adjusted DAC Code for LTC2688-16, Command 20

Command Code	Byte 1								Byte 2								Byte 3							
1000 A[3:0]	D15	D14	D13	D12	D11	D10	D9	D8	D7	D6	D5	D4	D3	D2	D1	D0	0	0	0	0	0	0	0	0

Table 21. SDO Pin Data-Word Readback of Offset and Gain Adjusted DAC Code for LTC2688-12, Command 20

Command Code	Byte 1								Byte 2								Byte 3							
1000 A[3:0]	D11	D10	D9	D8	D7	D6	D5	D4	D3	D2	D1	D0	0	0	0	0	0	0	0	0	0	0	0	

## THEORY OF OPERATION

## Gain Adjustment

The device supports a gain adjustment range from 1.5× to 0.5×, or ±50%. Table 22 shows gain adjustment ranges and corresponding codes.

Negative gain adjustments are encoded in twos complement binary data format. The following formula shows the calculation of the gain adjustment code,  $G^{CODE}$ :

$$G^{CODE} = \text{round}\left(2^M \times \frac{G\%}{100}\right) \quad (1)$$

where:

$G^{CODE}$  is the gain adjustment code.

Table 22. Gain Adjust Range and Codes,  $M = 16$

Gain Adjust, $G\%$ <sup>1</sup>	Unit	$G^{CODE}$ , G[15:0] <sup>1</sup>
+50	%FS	0111...111
...		...
+30.5	ppm FS	0000...010
+15.3	ppm FS	0000...001
0	ppm FS	0000...000
-15.3	ppm FS	1111...111
-30.5	ppm FS	1111...110
...		...
-50	%FS	1000...000

<sup>1</sup> The ellipses (...) indicate a sequential continuation of the numbering scheme.

Table 23. Writing Gain Adjustment to a DAC Channel, Command 3 for LTC2688-16

Command Code	Byte 1								Byte 2								Byte 3							
0011 A[3:0]	G15	G14	G13	G12	G11	G10	G9	G8	G7	G6	G5	G4	G3	G2	G1	G0	X	X	X	C/X	C/X	C/X	C/X	C/X

Table 24. Gain Adjust Range and Codes,  $M = 12$

Gain Adjust, $G\%$ <sup>1</sup>	Unit	$G^{CODE}$ , G[11:0] <sup>1</sup>
+50	%FS	0111...111
...		...
+30.5	ppm FS	0000...010
+15.3	ppm FS	0000...001
0	ppm FS	0000...000
-15.3	ppm FS	1111...111
-30.5	ppm FS	1111...110
...		...
-50	%FS	1000...000

<sup>1</sup> The ellipses (...) indicate a sequential continuation of the numbering scheme.

Table 25. Writing Gain Adjustment to a DAC Channel, Command 3 for LTC2688-12

Command Code	Byte 1								Byte 2				Byte 3											
0011 A[3:0]	G11	G10	G9	G8	G7	G6	G5	G4	G3	G2	G1	G0	0	0	0	0	X	X	X	C/X	C/X	C/X	C/X	C/X

$G\%$  is the desired gain adjustment.

$M$  is the resolution parameter listed in Table 22.

Use Command 3 (see Table 23) to program the gain adjustments.

Note that after writing to the gain registers of a DAC channel, the gain adjustment does not take effect until a code is written to the DAC. Use Command 20 to read back the offset and gain adjusted DAC code.

Table 20 shows the adjusted data-word that appears at the SDO pin after Command 20 is written.

## THEORY OF OPERATION

## ANALOG MUX

The LTC2688 includes an analog high voltage multiplexer (mux) for monitoring the 16 DAC output voltages and load currents and takes voltage measurements at the MUX pin (Pin 12). The MUX pin is intended for use with high impedance loads only. Continuous dc output current at the MUX pin must be limited to  $\pm 200 \mu\text{A}$  to avoid damaging internal circuits. The output impedance of the multiplexer

is  $3.5 \text{ k}\Omega$ . However, when using the multiplexer to measure load current ( $V_{\text{SENSE}}$ ), the output impedance is typically  $100 \text{ k}\Omega$ . The output voltage range of the multiplexer is from  $V^-$  to  $(V1^+ - 1.4 \text{ V})$ . Note that when the mux is disabled ( $\text{ENMUX} = 0$ ), the MUX pin is high impedance, which is the default at power-up. For enabling the mux and selecting a signal with the  $\text{M}[9:0]$  bits, use Command 12 (shown in Table 27) to set the mux control register.

Table 26. Analog Mux Control Addresses

M9	M8	M7	M6	M5	M4	M3	M2	M1	M0	MUX Pin State
1	1	0	0	0	0	0	0	0	0	DAC0 voltage output
1	1	0	0	0	0	0	0	0	1	DAC1 voltage output
1	1	0	0	0	0	0	0	1	0	DAC2 voltage output
1	1	0	0	0	0	0	0	1	1	DAC3 voltage output
1	1	0	0	0	0	0	1	0	0	DAC4 voltage output
1	1	0	0	0	0	0	1	0	1	DAC5 voltage output
1	1	0	0	0	0	0	1	1	0	DAC6 voltage output
1	1	0	0	0	0	0	1	1	1	DAC7 voltage output
1	1	0	0	0	0	1	0	0	0	DAC8 voltage output
1	1	0	0	0	0	1	0	0	1	DAC9 voltage output
1	1	0	0	0	0	1	0	1	0	DAC10 voltage output
1	1	0	0	0	0	1	0	1	1	DAC11 voltage output
1	1	0	0	0	0	1	1	0	0	DAC12 voltage output
1	1	0	0	0	0	1	1	0	1	DAC13 voltage output
1	1	0	0	0	0	1	1	1	0	DAC14 voltage output
1	1	0	0	0	0	1	1	1	1	DAC15 voltage output
0	0	0	0	0	0	0	0	0	0	DAC0 $V_{\text{SENSE}}$ output
0	0	0	0	0	0	0	0	0	1	DAC1 $V_{\text{SENSE}}$ output
0	0	0	0	0	0	0	0	1	0	DAC2 $V_{\text{SENSE}}$ output
0	0	0	0	0	0	0	0	1	1	DAC3 $V_{\text{SENSE}}$ output
0	0	0	0	0	0	0	1	0	0	DAC4 $V_{\text{SENSE}}$ output
0	0	0	0	0	0	0	1	0	1	DAC5 $V_{\text{SENSE}}$ output
0	0	0	0	0	0	0	1	1	0	DAC6 $V_{\text{SENSE}}$ output
0	0	0	0	0	0	0	1	1	1	DAC7 $V_{\text{SENSE}}$ output
0	0	0	0	0	0	1	0	0	0	DAC8 $V_{\text{SENSE}}$ output
0	0	0	0	0	0	1	0	0	1	DAC9 $V_{\text{SENSE}}$ output
0	0	0	0	0	0	1	0	1	0	DAC10 $V_{\text{SENSE}}$ output
0	0	0	0	0	0	1	0	1	1	DAC11 $V_{\text{SENSE}}$ output
0	0	0	0	0	0	1	1	0	0	DAC12 $V_{\text{SENSE}}$ output
0	0	0	0	0	0	1	1	0	1	DAC13 $V_{\text{SENSE}}$ output
0	0	0	0	0	0	1	1	1	0	DAC14 $V_{\text{SENSE}}$ output
0	0	0	0	0	0	1	1	1	1	DAC15 $V_{\text{SENSE}}$ output
1	0	0	0	0	0	0	0	0	0	REFL (Pin 14)
1	0	0	0	0	1	0	0	0	0	$V_{\text{CC}}$
1	0	0	0	1	0	0	0	0	0	$V_{\text{REF}}$
1	0	0	0	1	1	0	0	0	0	Voltage proportional to absolute temperature ( $V_{\text{PTAT}}$ ), $T_{\text{J}} = 25^\circ\text{C} + (V_{\text{PTAT}} - 2.44)/(7.95 \times 10^{-3})$

## THEORY OF OPERATION

Table 27. Mux Control Register, Command 12

Command Code		Byte 1									Byte 2							Byte 3									
0111	0101	X	X	X	X	X	ENMUX	M9	M8	M7	M6	M5	M4	M3	M2	M1	M0	X	X	X	X	X	X	X	X	X	X

Setting the ENMUX bit (default value is 0) enables the mux. The M[9:0] bits (default value is 0x000) are mux address bits. See Table 27 for signal selection. To read the mux control register, use Command 29. The data-word containing the mux control register appears at the SDO pin in the next command cycle. See the Read Commands section for details.

If the M[9:0] bits are set to monitor the  $V_{SENSE}$  voltage of a DAC channel output, a voltage that represents the load current of the corresponding DAC channel appears at the MUX pin (Pin 12). The DAC channel load current can be calculated using the  $V_{SENSE}$  voltage and the DAC channel output voltage,  $V_{OUT}$ . If  $V_{SENSE} < 2.048$  V, use Equation 2 to calculate the load source current.

$$I_{LOAD SOURCE} = \frac{1}{6} \times \sqrt{1 - \frac{V_{SENSE}}{5}} - 0.128 - \frac{\beta \times V_{OUT}}{25,000} \quad (2)$$

If  $V_{SENSE} > 2.048$  V, use Equation 3 to calculate the load sink current.

$$I_{LOAD SINK} = \frac{\sqrt{2.048} - \sqrt{V_{SENSE}}}{16.2} - \frac{\beta \times V_{OUT}}{25,000} \quad (3)$$

where:

$I_{LOAD SOURCE}$  and  $I_{LOAD SINK}$  are in amperes.

$I_{LOAD SOURCE}$  is a positive value, indicating current is flowing out of the DAC output, and  $I_{LOAD SINK}$  is a negative value, indicating current is flowing into the DAC channel.

$V_{SENSE}$  and  $V_{OUT}$  are in volts.

$\beta$  is calculated as follows:

$$\beta = 1 - \frac{4}{Span Range} \quad (4)$$

where *Span Range* is the voltage range of the DAC channel (5 for 0 V to 5 V range, 10 for 0 V to 10 V range or  $\pm 5$  V range, 20 for  $\pm 10$  V range, and 30 for  $\pm 15$  V range).

Using Equation 2 through Equation 4, the load current monitor has a typical  $V_{SENSE}$  error of under 800  $\mu$ A (see Figure 24).

Alternatively, use the following simpler formula to measure the load current,  $I_{LOAD}$ :

$$I_{LOAD} = \frac{(2.048 - V_{SENSE})}{50} \quad (5)$$

where:

$I_{LOAD}$  is in amperes. A negative  $I_{LOAD}$  indicates a sinking load current, and a positive  $I_{LOAD}$  indicates a sourcing current.  $I_{LOAD}$  has an error of less than 5% (see Figure 46).

$V_{SENSE}$  is in volts.

## TOGGLE AND DITHER OPERATION

The LTC2688 supports toggle and dither operations. Toggle operation enables fast switching of a DAC output between two different DAC codes without any SPI transaction, thereby eliminating communication transactions. Examples include injection of a small ac bias, or independently switching between on and off states. Dither operation adds a small sinusoidal wave to the digital DAC signal path. Dithering is a signal processing technique that involves the injection of ac noise to the signal path to reduce system nonlinearities. Each DAC channel can be programmed independently for either toggle or dither operation.

## Toggle Operation

Figure 53 illustrates toggle operation. Two unique DAC codes are stored in Input Register A and Input Register B. During toggle operation, a mux controlled by the toggle clock (TCK) determines which input register, either A or B, is latched into the DAC register. The user has control over TCK by choosing the toggle signal for each individual DAC channel by selecting TGPx (where x = 0, 1, or 2) or the software toggle bit.

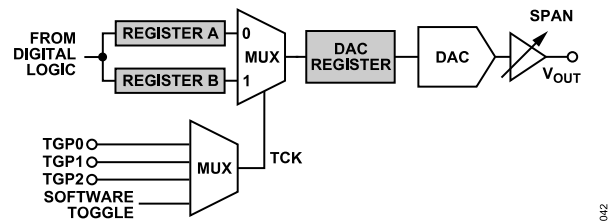

Figure 53. Toggle Operation

When the TCK signal is high the DAC outputs a voltage ( $V_A$ ) corresponding to Input Register A, and when TCK is low, the DAC outputs a voltage ( $V_B$ ) corresponding to Input Register B (see Figure 54). The toggle function can be disabled by writing 0x0000 to the toggle/dither enable register (Command 11).

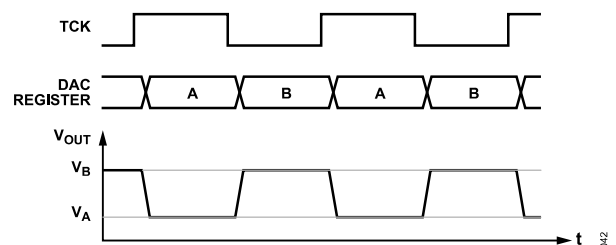

Figure 54. TCK Timing

**THEORY OF OPERATION**

**Toggle Operation Example**

As an example for the LTC2688, to set up Channel 0 for toggling between 32,768 and 32,767, use the TGP2 toggle pin to execute the following command sequence:

1. Write 0x0000 to the A/B select register (Command 9) to select Input Register A.
2. Write Code 0x2000 to Channel 0 (Command 0). Input Register A of Channel 0 is written.
3. Write 0x0001 to the A/B select register (Command 9) to select Input Register B.
4. Write Code 0x1FFF to Channel 0 (Command 0). Input Register B of Channel 0 is written. Input Register A and Input Register B hold the two desired codes. At this stage, Channel 0 is ready for the toggle operation.
5. Write 0x0030 to the channel setting register for Channel 0 (Command 1): mode = 0 and TD\_SEL[1:0] = 11. The TGP2 pin is thus selected as the toggle clock input.
6. Write 0x0001 to the toggle/dither enable register (Command 11).
7. Apply the toggle clock signal to the TGP2 pin. The DAC output voltage changes on the rising and falling edges of the toggle clock signal as shown in Figure 54.

**Dither Operation**

A dither signal generator injects a digital dither signal into the DAC signal path as shown in Figure 55.

The device generates a sinusoidal dither signal  $D(n)$  by accessing a lookup table (see Table 28), and corresponds to

$$D(n) = \sin\left(\frac{2\pi}{N}n + \varphi_0\right)$$

where:

$n = 0, 1, 2, \dots, N - 1$ .

$N$  is the signal period.

$\varphi_0$  is the phase angle, initial signal phase

Examples of the digital sinusoids are shown in Figure 56 and Figure 57. The user can select the TGPx pins or the software toggle bit as the dither clock (DCK) of the signal generator for each individual DAC channel. Signal parameters, represented by  $N$  and  $\varphi_0$ , can also be selected for each individual channel, which facilitates pre-

cise control of signal frequencies and phase relationships between dithered DAC channels. Note that,

$$f_{\text{SIGNAL}} = f_{\text{DCK}}/N$$

where:

$f_{\text{SIGNAL}}$  is the frequency of the dither signal.

$f_{\text{DCK}}$  is the dither clock frequency.

Before entering the digital DAC signal path, the sinusoidal dither,  $D(n)$ , is scaled and offset by values held in Input Register B and Input Register A, respectively, to form the final DAC input as expressed in the following equation.

$$\text{DAC Input} = A + B \times D(n)$$

The DAC is updated by the rising edge of the designated dither clock signal, DCK, which can be selected as TGPx or the software toggle bit.

**Table 28. Dither Signal Generator Lookup Table Using DIT\_PER[2:0] Bits**

Lookup Table Index	D(n) <sup>1</sup>				
	N = 4, 000	N = 8, 001	N = 16, 010	N = 32, 011	N = 64, 100
0	0				
1	1				
2		1			
3			0.9375		
4			1		
5				0.84375	
6				0.9375	
7				0.96875	
8				1	
9					0.78125
10					0.84375
11					0.875
12					0.9375
13					0.96875
14					0.96875
15					1
16					1

<sup>1</sup> Blank cells indicate no additional values required for N.

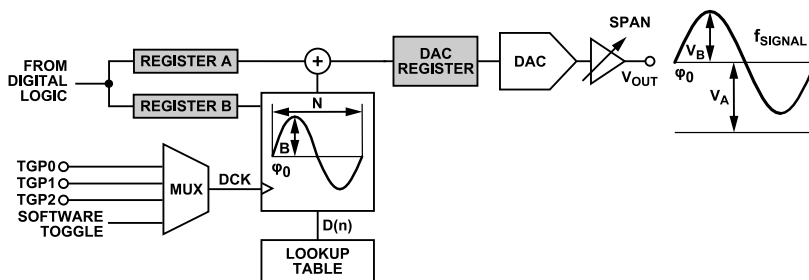

**Figure 55. Dither Signal Operation**

## THEORY OF OPERATION

## Example of Dither Operation

As an example, set up Channel 0 and Channel 1 in dither mode with the following specifications: dc value of 2 V in a  $\pm 5$  V output range, a sinusoidal amplitude of 10 mV, sinusoidal frequency of 10 kHz, a signal period of  $N = 64$  samples, and use the TGP1 pin as the dither clock input. The dither signals must be out of phase.

For the LTC2688-16, the dc value to be written to Input Register A is  $45,875 = 0xB333$ .

The range for dither amplitude is 1/4th the span range. [Table 29](#) shows Command 0 for programming the dither signal amplitude for the LTC2688. Note that the user must set two LSBs to 0.

For the LTC2688-16, Input Register B must be loaded with

$$\text{Code}(B) = \frac{10 \text{ mV}}{10 \text{ V}} \times 2^{16} = 66 = 0x0042 \quad (6)$$

For  $N = 64$ , set the toggle frequency to  $64 \times 10 \text{ kHz} = 640 \text{ kHz}$ . Set the initial phase value to 0 for Channel 0, and to 180 for Channel 1 (see Command 1 in [Table 13](#), [Table 34](#), and [Table 35](#)). If no phase relationship is required between different channels, the phase value is set to 0.

Execute the following series of steps to program all necessary registers:

1. Write 0x0000 to the A/B select register (Command 9) to select Input Register A for Channel 0 and Channel 1.

**Table 29. Bit Alignment for Dither Operation, Command 0**

Command Code	Byte 1										Byte 2						Byte 3											
0000 A[3:0]	D13	D12	D11	D10	D9	D8	D7	D6	D5	D4	D3	D2	D1	D0	0	0	X	X	C/X	C/X	C/X	C/X	C/X	C/X	C/X	C/X	C/X	C/X

2. Write Code 0xB333 to Channel 0 (Command 0). Input Register A of Channel 0 is written.
3. Write Code 0xB333 to Channel 1 (command 0). Input Register A of Channel 1 is written.
4. Write 0x0003 to the A/B select register (Command 9) to select Register B for Channel 0 and Channel 1.
5. Write Code 0x0042 to Channel 0 (Command 0). Input Register B of Channel 0 is written.
6. Write Code 0x0042 to Channel 1 (Command 0). Input Register B of Channel 1 is written.
7. Write the channel setting register (Command 1) for Channel 0 to set mode = 1, TD\_SEL[1:0] = 10, DIT\_PER[2:0] = 100, and DT\_PH[1:0] = 00. The TGP1 pin is selected as the dither clock input.
8. Write the channel setting register (Command 1) for Channel 1 to set mode = 1, TD\_SEL[1:0] = 10, DIT\_PER[2:0] = 100, and DT\_PH[1:0] = 00. The TGP1 pin is selected as the dither clock input.
9. Write 0x0003 to the toggle/dither enable register (Command 11) to enable dither in Channel 0 and Channel 1.
10. Apply a dither clock of 640 kHz to the TGP1 pin. The DAC outputs are updated with sinusoidal samples at the rising edge of TGP1. Before the toggle enable register is written, the DAC outputs Code A by default. After the toggle enable register is written, the channel is ready for dither.

**THEORY OF OPERATION**

**Disabling Dither Operation**

Dither operation can be disabled by resetting the toggle/dither enable register (Command 11). After this register is reset, the user must apply at least N clock cycles to ensure completion of the

sinusoidal dither signal cycle. Upon finishing the cycle, the dither operation is effectively disabled and regular DAC codes can then be written to the DAC channel. [Figure 58](#) illustrates this mechanism.

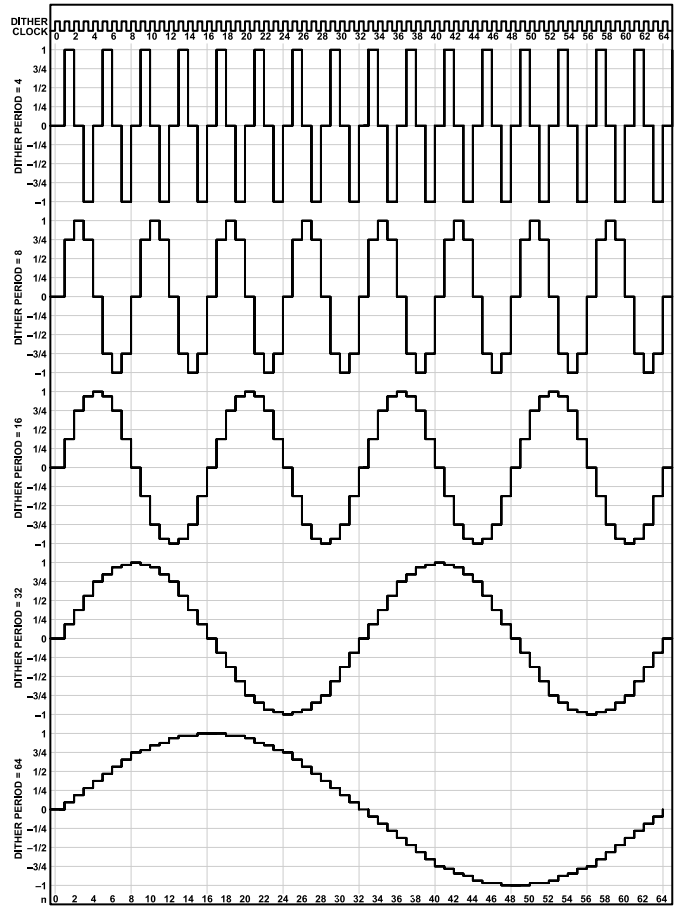

**Figure 56. Sinusoidal Waveforms for Various Values of Dither Period N**

THEORY OF OPERATION

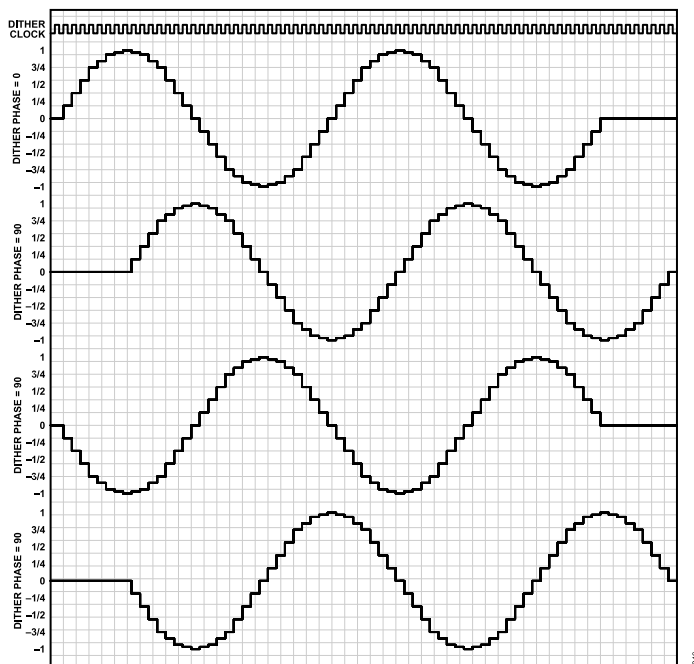

Figure 57. Sinusoidal Waveforms for Various Values of  $\phi_0$

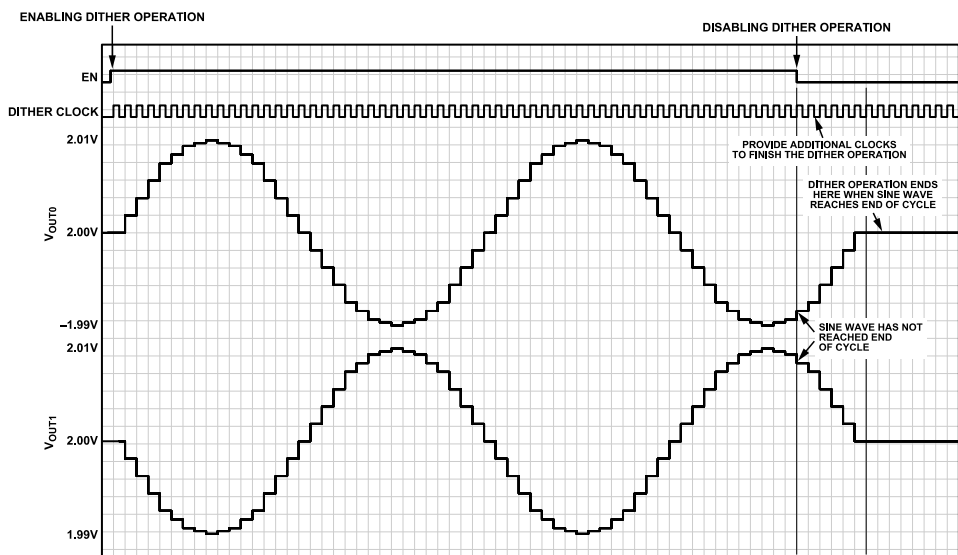

Figure 58. Termination of Sinusoidal Dither Waveforms

## THEORY OF OPERATION

## SPI Commands for Toggle/Dither Operations

SPI commands for setting up toggle and dither operation are as follows: write A/B select register (see Table 30), write software

toggle bit register (see Table 31), write toggle/dither enable register (see Table 32), and write channel settings register of DAC Channel x (see Table 13).

**Table 30. Write A/B Select Register, Command 9**

Command Code	Byte 1									Byte 2									Byte 3					
0111 0010	AB15	AB14	AB13	AB12	AB11	AB10	AB9	AB8	AB7	AB6	AB5	AB4	AB3	AB2	AB1	AB0	X	X	C/X	C/X	C/X	C/X	C/X	C/X

**Table 31. Write Software Toggle Bit Register, Command 10**

Command Code	Byte 1									Byte 2									Byte 3					
0111 0011	TB15	TB14	TB13	TB12	TB11	TB10	TB9	TB8	TB7	TB6	TB5	TB4	TB3	TB2	TB1	TB0	X	X	C/X	C/X	C/X	C/X	C/X	C/X

**Table 32. Write Toggle/Dither Enable Register, Command 11**

Command Code	Byte 1									Byte 2									Byte 3					
0111 0100	EN15	EN14	EN13	EN12	EN11	EN10	EN9	EN8	EN7	EN6	EN5	EN4	EN3	EN2	EN1	EN0	X	X	C/X	C/X	C/X	C/X	C/X	C/X

## THEORY OF OPERATION

### Write A/B Select Register

The command shown in [Table 30](#) writes the A/B select register, AB[15:0], controlling access to DAC Input Register A and DAC Input Register B for each DAC channel.

Each of the 16 bits in AB[15:0] controls write access to the A or B register for the respective DAC channel. Set AB<sub>x</sub> to 0 for DAC Channel x to write to Input Register A, and set AB<sub>x</sub> to 1 to write to Input Register B. The default value is 0x0000.

For example, AB<sub>15</sub> = 0 gives write access to the A Input Register of Channel 15, whereas AB<sub>15</sub> = 1 gives write access to the B Input Register of Channel 15.

### Write Software Toggle Bit Register

The command shown in [Table 31](#) writes the software toggle bit register, TB[15:0]. Each of the 16 bits in TB[15:0] acts as a software controlled toggle pin for the respective DAC channel. Note that the

transition of a toggle bit is defined by the  $\overline{CS}/LD$  rising edge at the end of the command frame. The default value is 0x0000.

### Write Toggle/Dither Enable Register

The command shown in [Table 33](#) writes the toggle/dither enable register, EN[15:0]. Set EN<sub>x</sub> = 1 to enable toggle or dither functionality for the DAC Channel x. Set EN<sub>x</sub> = 0 to disable toggle or dither functionality. The default value is 0x0000. The toggle/dither enable register is also used as a start or stop function for the dither operation.

In toggle mode, disabling toggle connects the DAC channel to Input Register A. In sinusoidal dither mode, disabling toggle causes the DAC channel to finish the sine wave cycle before connecting to Input Register A. This procedure requires the user to apply enough dither clock cycles to complete the sine wave cycle after toggle functionality is stopped.

**Table 33. Write Toggle/Dither Enable Register, Command 11**

Command Code	Byte 1								Byte 2								Byte 3							
0111 0100	EN15	EN14	EN13	EN12	EN11	EN10	EN9	EN8	EN7	EN6	EN5	EN4	EN3	EN2	EN1	EN0	X	X	C/X	C/X	C/X	C/X	C/X	C/X

## THEORY OF OPERATION

### Write Channel Settings Register of DAC Channel x

Command 1 in [Table 13](#) writes the channel settings register of DAC Channel = A[3:0], where X is don't care and C represents the CRC code bits.

The mode bit selects toggle mode or sinusoidal dither mode. Set to 0 for toggle mode and set to 1 for sinusoidal dither mode (the default value is 0). The dither period can be selected with DIT\_PER[2:0], as shown in [Table 34](#) (the default value is 0b000). Note that dither signal frequency ( $f_{\text{SIGNAL}}$ ) and dither clock frequency ( $f_{\text{DCK}}$ ) are related, as shown in [Table 34](#). [Figure 56](#) illustrates the various dither period settings.

**Table 34. Dither Period Settings**

DIT_PER[2:0]	N	$f_{\text{SIGNAL}}$
000 (Default)	4	$f_{\text{DCK}}/4$
001	8	$f_{\text{DCK}}/8$
010	16	$f_{\text{DCK}}/16$
011	32	$f_{\text{DCK}}/32$
100	64	$f_{\text{DCK}}/64$
Other Settings Not Allowed		

The initial dither phase,  $\varphi_0$ , of the dither signal can be set with DIT\_PH[1:0], as shown in [Table 35](#) (the default value is 0b00). [Figure 57](#) illustrates different initial phase values. The selection of initial dither phase ( $\varphi_0$ ) is useful if two or more channels require sinusoidal waves with a relative phase offset between them. For example, if differential dithered signals are needed, Channel 0 and Channel 1 can be programmed to have the same dither clock signal and the same dither period. However, Channel 0 can be set to have Initial Phase 0° and Channel 1 can be set to have Initial Phase 180° (see [Table 35](#)).

**Table 35. Dither Phase Settings**

DIT_PH[1:0]	Initial Dither Phase, $\varphi_0$
00	0°
01	90°
10	180°
11	270°

Note that if the initial dither phase ( $\varphi_0$ ) is set to 90° or 270°, the first N/4 clock does not produce dither outputs (see [Figure 57](#)).

TD\_SEL[1:0] control the toggle/dither select mux that chooses between the three toggle/dither pins and the software toggle/dither bit. The default value is 0b00 (see [Table 36](#)).

**Table 36. Toggle/Dither Clock Settings**

TD_SEL[1:0]	Toggle/Dither Clock
00	Software toggle bit
01	TGP0 pin
10	TGP1 pin
11	TGP2 pin

### DAISY-CHAIN MODE

Data transferred to the device from the SDI input is delayed by 32 SCK rising edges before being output at the SDO pin at the next SCK falling edge, suitable for clocking into the microprocessor on the next 32 SCK rising edges.

The SDO output can be used to facilitate control of multiple serial devices from a single 3-wire serial port (that is, SCK, SDI, and  $\overline{\text{CS}}/\text{LD}$ ). Such a daisy-chain series is configured by connecting the SDO of each upstream device to the SDI of the next device in the chain. The shift registers of the devices are thus connected in series, effectively forming a single-input shift register that extends through the entire chain. Thus, the devices can be addressed and controlled individually by simply concatenating their input words. The first instruction addresses the last device in the chain and so forth. The SCK and  $\overline{\text{CS}}/\text{LD}$  signals are common to all devices in the series.

In use,  $\overline{\text{CS}}/\text{LD}$  is first taken low. Then, the concentrated input data is transferred to the chain, using the SDI of the first device as the data input. When the data transfer is complete,  $\overline{\text{CS}}/\text{LD}$  is taken high, completing the instruction sequence for all devices simultaneously. A single device can be controlled by using the no operation command for all other devices in the chain. When  $\overline{\text{CS}}/\text{LD}$  is taken high, the SDO pin presents a high impedance output. Therefore, a pull-up resistor is required at the SDO pin of each device (except the last) for daisy-chain operation.

### POWER-DOWN MODE

For power sensitive applications, power-down mode can reduce the supply current whenever fewer than 16 DAC outputs are needed. When in power-down, the output amplifiers and reference buffers are disabled. The DAC outputs are put into a high impedance state, and the output pins are passively pulled to ground through individual 25 k $\Omega$  (minimum) resistors. Any channel or combination of channels can be put into power-down mode by using Command 8 (see [Table 37](#)). Command 8 writes the power-down register, P[15:0], controlling the power-down status of each DAC channel, where X is don't care and C represents the CRC code bits for error correction.

Channel x is powered down when  $P_x = 1$ . Channel x is powered up when  $P_x = 0$ . The default value is 0x0000.

Applying an update to DAC Channel x, Command 6 also powers up DAC Channel x. A software reset ( $\text{RST} = 1$ , Command 7) or a  $\overline{\text{CLR}}$  low pulse also powers up all DAC channels. The power-down register always accurately reflects the power-down status of the DAC channels. Setting all 16 channels in power-down places the LTC2688 in a sleep mode (low current mode). That is, all active circuitry, including the internal reference and bias power down. Note that all on-chip registers retain their value during power-down. Normal operation resumes by undertaking one of the following actions:

## THEORY OF OPERATION

- ▶ Resetting one or more power-down (Px) bits in the power-down register (Command 8).
- ▶ Any command that involves an update of a DAC channel or a toggle/dither operation of a DAC channel.
- ▶ Pulling the asynchronous  $\overline{\text{LDAC}}$  pin low (see the [Pin Configuration and Function Descriptions](#) section).
- ▶ Pulling the  $\overline{\text{CLR}}$  pulse low powers up all DAC channels.
- ▶ Issuing a software reset by setting RST = 1 (Command 7).

When updating a powered down DAC channel, add wait time to accommodate the extra power-up delay (50  $\mu\text{s}$ ). If the entire chip is powered down, allow longer power-up times. The full chip power-up time depends on the charge state of the reference bypass capacitors.

Read the power-down register with Command 25. The data-word containing the power-down register appears at the SDO pin in the next command cycle, and has the same structure as Command 8.

**Table 37. Power-Down Command Structure, Command 8**

Command Code	Byte 1										Byte 2						Byte 3							
0111 0001	P15	P14	P13	P12	P11	P10	P9	P8	P7	P6	P5	P4	P3	P2	P1	P0	X	X	C/X	C/X	C/X	C/X	C/X	C/X

## THEORY OF OPERATION

ASYNCHRONOUS DAC UPDATE USING  $\overline{\text{LDAC}}$ 

In addition to the update commands shown in [Table 8](#) and [Table 9](#), the asynchronous, active low  $\overline{\text{LDAC}}$  pin updates all 16 DAC registers with the contents of the input registers. When  $\overline{\text{CS/LD}}$  is high, a low on the  $\overline{\text{LDAC}}$  causes all DAC registers to be updated with the contents of the input registers. When  $\overline{\text{CS/LD}}$  is low, a low on the  $\overline{\text{LDAC}}$  pin before the rising edge of  $\overline{\text{CS/LD}}$  powers up all DAC outputs, but does not cause the outputs to be updated. If  $\overline{\text{LDAC}}$  remains low after the rising edge of  $\overline{\text{CS/LD}}$ ,  $\overline{\text{LDAC}}$  is recognized, the command specified in the 24-bit word is executed, and the DAC outputs are updated. The DAC outputs are powered up when  $\overline{\text{LDAC}}$  is taken low, independent of the state of  $\overline{\text{CS/LD}}$ . If  $\overline{\text{LDAC}}$  is low at the time  $\overline{\text{CS/LD}}$  goes high, any software power-down command that was specified in the input word is inhibited.

## FAULT DETECTION

The LTC2688 provides notifications of operational fault conditions. Use Command 30 to read the fault register. [Table 38](#) lists the fault register bits and their associated trigger conditions for Command 13 and Command 30. The data-word containing the fault register appears at the SDO pin in the next command cycle (see the [Read Commands](#) section).

Table 38. Fault Register Bits and Conditions

Bit	Fault Condition
TSF	Thermal shutdown fault. If die temperature $T_J > 160^\circ\text{C}$ , TSF is set and thermal protection is activated. Disable using Command 7, Register Bit TSD_DIS. See the <a href="#">Thermal Overload Protection</a> section for details.
CKF	Clock fault. If an invalid number for clock cycles is detected during a SPI sequence, CKF is set. The clock count must equal integer multiples of 32 (for example: 32, 64, 96, ...). The use of only 24 clock cycles is also permitted.
CF	Command fault. This fault is triggered if the optional CRC error checking detects a data transmission error. To activate CRC error checking, use Command 7, Bit SPI_CRC.

The device responds to a fault condition in two different ways.

- ▶ Fault register: the device sets the fault register flags (TSF, CKF, and CF) to indicate the cause of the fault. The user can read and reset the fault register with the read/write fault register (Command 30 and Command 13). Note that the TSF, CKF, and CF fault bits are not automatically reset, unless the device undergoes a power cycle, a low on the  $\overline{\text{CLR}}$  pin, or a software reset.
- ▶  $\overline{\text{FAULT}}$  pin: when a fault condition is detected, the  $\overline{\text{FAULT}}$  pin (Pin 38) engages. The  $\overline{\text{FAULT}}$  pin is a digital open-drain output and pulls low in case of a fault. The  $\overline{\text{FAULT}}$  pin releases on the next rising edge of  $\overline{\text{CS/LD}}$ .

Disable thermal protection and CRC error checking by using Command 7 to configure the TSD\_DIS and SPI\_CRC bits (see the [Configuration Register](#) section.) To reset the fault register, use Command 13 as shown in [Table 39](#).

Table 39. Write Fault Register, Command 13

Command Code	Byte 1												Byte 2			Byte 3											
0111 0110	0	0	0	0	0	0	0	0	0	0	0	0	0	0	TSF	CKF	CF	X	X	X	X	X	X	X	X	X	X

Table 40. Read Fault Register, Command 30

Command Code	Byte 1												Byte 2			Byte 3											
1111 0110	0	0	0	0	0	0	0	0	0	0	0	0	0	0	TSF	CKF	CF	X	X	X	X	X	X	X	X	X	X

## THEORY OF OPERATION

## CONFIGURATION REGISTER

Table 41. Configuration Register Command, Command 7

Command Code	Byte 1												Byte 2			Byte 3								
0111 0000	RST	0	0	0	0	0	0	0	0	0	0	0	0	TSD_DIS	EXT_REF	SPI_CRC	X	X	X	X	X	X	X	X

The LTC2688 has a configuration register that can be set with Command 7 (see Table 41).

**Software Reset**

Use the RST bit for a software reset. Writing a 1 to RST performs a software reset. The RST bit self clears and the default value is 0.

**Thermal Shutdown Disable**

Use the TSD\_DIS bit for thermal shutdown disable. When TSD\_DIS = 1, thermal shutdown is disabled for all DAC channels. The default value is 0 (enabled).

**External Reference Mode**

Setting EXT\_REF = 1 activates external reference mode and disables the REF\_COMP charging current. The default value is 0.

**SPI Cyclic Redundant Check Enable/Disable**

The LTC2688 supports error checking for SPI transactions to verify that data has been received correctly in noisy environments. The error checking is based on a 6-bit cyclic redundancy check (CRC-6). To use this feature, the device controlling the LTC2688 must generate a 6-bit checksum that is added to the end of the third data byte of a 32-bit SPI transaction. The CRC error checking algorithm is based on the following polynomial:

$$C(x) = x^6 + x^1 + 1$$

If a data transmission error is detected, the faulty SPI transaction does not execute, a command integrity fault is issued, and the FAULT pin (Pin 38) triggers (see the Fault Detection section). Use Command 7 to enable or disable CRC error checking (see Table 41).

The SPI\_CRC bit enables or disables the SPI CRC error checking. SPI\_CRC = 1 enables CRC error checking.

By default, CRC error checking is disabled (SPI\_CRC = 0). CRC error checking is always skipped for write and read configuration register commands and write and read fault register commands: Command 7, Command 13, Command 24, and Command 30.

**Read Configuration Register**

To read the configuration register, use Command 24. The data-word containing the current configuration register settings appears at the SDO pin in the next command cycle (see the Read Commands section).

**REFERENCE MODES**

The LTC2688 has two reference modes: internal and external reference mode. In the internal reference mode, the reference voltage is generated by an on-board reference, whereas in external reference mode, the reference voltage is supplied by an external voltage reference. In both the internal and external reference modes, the voltage at the REF pin and the span range setting determine the full-scale voltage of each DAC channel.

The device includes a precision 4.096 V integrated reference with a typical temperature drift of  $\pm 2$  ppm/ $^{\circ}$ C. To use the internal reference, leave the REF\_COMP pin floating (no dc path to ground). In addition, reset the EXT\_REF bit in the configuration register (EXT\_REF = 0) using Command 7.

A buffer is required for the internal reference to drive external circuitry. For reference stability and low noise, tie a 0.1  $\mu$ F capacitor between REF\_COMP and GND. In this configuration, the REF pin can drive up to 0.1  $\mu$ F. To ensure stable operation, the capacitive load on the REF pin must not exceed the load on the REF\_COMP pin.

To use an external reference, the REF\_COMP pin must be tied to ground, which disables the output of the internal reference at start-up, so that the REF pin becomes a high impedance input. Apply the desired reference voltage at the REF pin after powering up, and set the EXT\_REF bit to 1 using Command 7. The acceptable external reference voltage range is as follows:

$$2.0 \text{ V} \leq V_{REF} \leq V_{CC} - 0.6 \text{ V}$$

**Integrated Reference Buffer**

Each DAC channel has its own integrated high performance reference buffer. The buffers have very high input impedance and do not load the reference voltage source. These buffers shield the reference voltage from glitches caused by DAC switching and, thus, minimize DAC to DAC dynamic crosstalk. Typically, DAC to DAC crosstalk is 1 nV-sec (0 V to 5 V range). See Figure 17 in the Typical Performance Characteristics section.

**VOLTAGE OUTPUTS**

The ability of an amplifier to maintain its rated voltage accuracy over a wide range of load conditions is characterized in its load regulation specification. The change in output voltage is measured in milliampere (mA) of forced load current change. The LTC2688 high voltage, rail-to-rail output amplifier has guaranteed load regulation

## THEORY OF OPERATION

when sourcing or sinking up to 20 mA with supply headroom as low as 2.2 V.

DC output impedance is equivalent to load regulation, and can be derived from it by simply calculating a change in units from  $\mu\text{V}/\text{mA}$  to  $\Omega$ . The dc output impedance of the amplifier is typically  $0.07 \Omega$  when driving a load with at least 2.2 V of headroom.

When drawing a load current from either rail, the output voltage headroom with respect to that rail is limited by the typical channel resistance of the output devices— $70 \Omega$  for the high-side output device and  $30 \Omega$  for the low-side output device. Worst case channel resistances for the high-side and low-side output devices are estimated to be  $110 \Omega$  and  $60 \Omega$ , respectively. For example, when sourcing 1 mA, the maximum output voltage (below  $V_{x^+}$ ) is  $70 \Omega \times 1 \text{ mA} = 70 \text{ mV}$ . See [Figure 10](#) and [Figure 11](#) in the [Typical Performance Characteristics](#) section. The amplifiers are stable, driving capacitive loads of up to 1 nF.

## THERMAL OVERLOAD PROTECTION

The LTC2688 protects itself from damage if the die temperature exceeds  $160^\circ\text{C}$ . Each of the 16 DAC channels has an independent temperature sensor. If a particular channel overheats, it shuts itself down and triggers a TSF fault. That is, the TSF flag in the fault register is set (see [Table 38](#)), and the open-drain FAULT pin (Pin 38) pulls low. Moreover, the bit corresponding to the channel in thermal shutdown is set in both the power-down register (see

[Table 37](#)) and the thermal shutdown status register (see [Table 42](#)). These registers can be read using Command 25 and Command 31, respectively. All other channels that did not overheat continue to operate normally. However, if all 16 channels trigger thermal shutdown, the entire chip powers down, including reference and bias circuitry. When triggered, all thermally shut down channels remain in shutdown mode, even if the temperature has fallen. To exit thermal shutdown mode, the temperature must first decrease to below about  $150^\circ\text{C}$  on all channels. The user can then power up the shutdown channels in one of four different ways:

- ▶ Reset the  $\overline{\text{FAULT}}$  register (Command 13), and reset the power-down register (Command 8).
- ▶ Issue a software reset using Command 7.
- ▶ Power cycle the device.
- ▶ Issue a reset on the  $\overline{\text{CLR}}$  pin (Pin 21). A  $\overline{\text{CS}}/\text{LD}$  rising edge releases the pin regardless of die temperature.

[Table 42](#) shows the structure of the thermal shutdown status register, which can be read with Command 31. TSDx represents the thermal shutdown status of Channel x. Because the total load current of the device can easily exceed 100 mA, carefully evaluate the die heating potential of the system design. Grounded loads as low as  $1 \text{ k}\Omega$  can be used without resulting in excessive heat. Disable thermal protection by using the SPI Command 7 to set the TSD\_DIS bit in the configuration register.

**Table 42. Read Thermal Shutdown Status Register, Command 31**

Command Code	Byte 1								Byte 2								Byte 3							
1111 0111	TSD 15	TSD 14	TSD 13	TSD 12	TSD 11	TSD 10	TSD 9	TSD 8	TSD 7	TSD 6	TSD 5	TSD 4	TSD 3	TSD 2	TSD 1	TSD 0	X	X	C/X	C/X	C/X	C/X	C/X	C/X

## APPLICATIONS INFORMATION

### PRINTED CIRCUIT BOARD LAYOUT

The excellent  $70 \mu\text{V}/\text{mA}$  load regulation and  $\pm 2 \mu\text{V}$  dc crosstalk performance of the LTC2688 are achieved partially by minimizing common-mode resistance of signal and power ground. As with any high resolution converter, clean board grounding is important. A low impedance analog ground plane is necessary, as are star grounding techniques. The user is advised to keep the board layer used for star ground continuous to minimize ground resistance. That is, use the star ground concept without using separate star traces. Keep resistance from REFL pin to GND as low as possible.

For optimal performance, stitch the ground plane with arrays of vias on 150 mil to 200 mil centers to form a connection with ground pours from the other board layers. These layout techniques reduce overall ground resistance and minimize ground loop area.

The mechanical stress caused by soldering parts to a PCB may cause the reference output voltage to shift and the temperature coefficient to change. To reduce the effects of stress related shifts, mount the LTC2688 near the short edge of a PCB or in a corner. Using circuit boards that are thicker and smaller, with a lower aspect ratio, reduces mechanical stress. In addition, slots can be cut into the PCB on two sides of the device to reduce stress.

When using the WLCSP package, follow the layout guidelines in [AN-617 Application Note, Wafer Level Chip Scale Package](#).

### Using the LTC2688 in 5 V Single-Supply Systems

The LTC2688 can be used in single-supply systems simply by connecting the  $V^-$  pins to ground along with REFL and GND, while  $Vx^+$  and VCC are connected to a 5 V supply. IOVCC can be connected to the 5 V supply or to a logic supply voltage of lower than 5 V.

With the internal reference, use the 0 V to 5 V span for DAC channel outputs. As with any rail-to-rail device, the output is limited to voltages within the supply range. Because the outputs of the device cannot go below ground, the lowest DAC code may limit the output, as shown in [Figure 59](#). Similarly, limiting can occur near full-scale if full-scale error ( $\text{FSE} = V_{\text{OS}} + \text{GE}$ ) is positive, or if  $Vx^+$  is less than the full scale voltage (see [Figure 60](#)).

The multiplexer is fully functional in single-supply operation. However, output voltages are limited to between ground and 3.6 V ( $Vx^+ = 5 \text{ V}$ ).

More flexibility can be afforded by using an external reference. For example, by using a 2.048 V reference, such as the [LTC6655](#), ranges between  $0x$  to  $2x$  and  $0x$  to  $4x$  can be selected, which give full-scale voltages of 2.5 V and 5 V, respectively. Furthermore, the device can be configured for reset to zero scale or midscale codes (see the [Span Selection and Channel Settings](#) section).

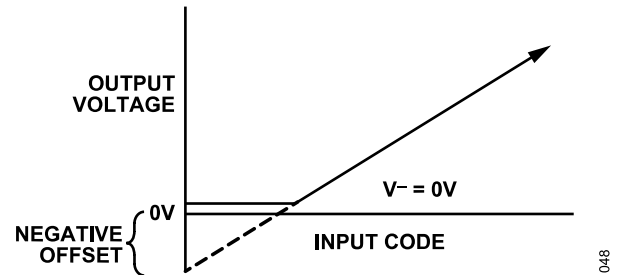

Figure 59. Effects of 0 V to 5 V Output Range for Single-Supply Operation, Overall Transfer Function

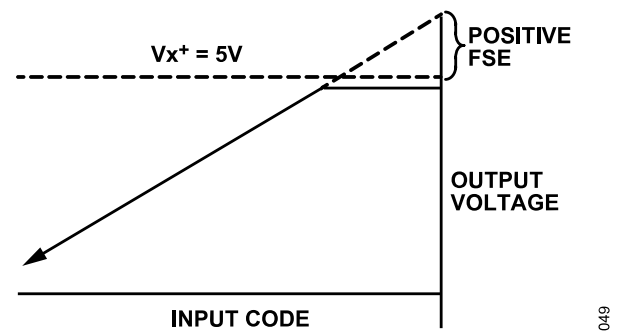

Figure 60. Effect of Negative Offset for Codes Near Zero Scale

## COMMAND ADDRESSES

The syntax of the read commands are identical to the corresponding write commands. For instance, Command 24 (read configuration register bits) has the same syntax as the write configuration

register, Command 7. The bit structure of Command 16 and Command 17 is the same as Command 1. Blank cells in Table 43 mean not applicable.

Table 43. Write Commands

Command No.	Instruction	Command Address	Bit(s)	Bit Name	Description	Reset Value	R/W
0	Write code to DAC Channel x	0x0 A[3:0]	[23:8]	D15 to D0	16-bit DAC code of Channel A[3:0] for LTC2688-16.	All 0	W
			[23:12]	D11 to D0	12-bit DAC code of Channel A[3:0] for LTC2688-12.		
1	Write channel settings to DAC Channel x (A[3:0])	0x1 A[3:0]	19	Mode	Toggle mode register. When the mode bit is set, the device is in toggle mode. When the mode bit is reset, the device is in dither mode.	0	R/W
			[18:17]	DIT_PH1, DIT_PH0	Dither phase, sets the phase of the sinusoidal dither signal (see Table 35).	00	R/W
			[16:14]	DIT_PER2, DIT_PER1, DIT_PER0	Dither Period N, sets the Period N of sinusoidal dither signal (see Table 34).	000	R/W
			[13:12]	TD_SEL1, TD_SEL0	Controls the toggle select mux that chooses between the three toggle pins and the software pin (see Table 36).	00	R/W
			[11:8]	S3 to S0	Span settings (see Table 14 and Table 15).	0x0	R/W
2	Write offset adjust to DAC Channel x	0x2 A[3:0]	[23:10]	O13 to O0	DAC offset adjust value of Channel A[3:0].	All 0	W
3	Write gain adjust to DAC Channel x	0x3 A[3:0]	[23:8]	G15 to G0	DAC gain adjust value of Channel A[3:0] for LTC2688-16.	All 0	W
			[23:12]	G11 to G0	DAC gain adjust value of Channel A[3:0] for LTC2688-12.		
4	Write code to DAC Channel x, update DAC Channel x	0x4 A[3:0]	[23:8]	D15 to D0	16-bit DAC code of Channel A[3:0] for LTC2688-16.	All 0	W
			[23:12]	D11 to D0	12-bit DAC code of Channel A[3:0] for LTC2688-12.		
5	Write code to DAC Channel x, update all DAC channels	0x5 A[3:0]	[23:8]	D15 to D0	16-bit DAC code of Channel A[3:0] for LTC2688-16.	All 0	W
			[23:12]	D11 to D0	12-bit DAC code of Channel A[3:0] for LTC2688-12.		
6	Update DAC Channel x	0x6 A[3:0]			Updates the DAC register for Channel A[3:0].		
7	Write Configuration Register	0x70	23	RST	Software reset. Writing a 1 to RST performs a software reset.	0	W
			10	TSD_DIS	Thermal shutdown disable. When TSD_DIS = 1, thermal shutdown is disabled for all DAC channels.	0	R/W
			9	EXT_REF	External reference mode. Setting EXT_REF = 1 sets the external reference mode and disables the REFCOMP charging current.	0	R/W
			8	SPI_CRC	SPI cyclic redundancy check. Setting SPI_CRC = 1 enables the CRC.	0	R/W
8	Write power-down register	0x71	[23:8]	P15 to P0	Power-down register controlling the power-down status of all DAC channels. P[15:0] controls DAC Channel x. P[15:0] = 1 powers down the DAC Channel x, P[15:0] = 0 powers up the DAC Channel x.	All 0	R/W
9	Write A/B select register	0x72	[23:8]	AB15 to AB0	A/B select register controlling access to DAC Input Register A and Input Register B for each DAC channel. ABx controls DAC Channel x. Reset ABx to write to Input Register A, set ABx to write to Input Register B.	All 0	R/W
10	Write software toggle bit register	0x73	[23:8]	TB15 to TB0	Software toggle bit register acting as a software controlled toggle bit for each DAC channel. TBx controls DAC Channel x. When TBx changes from 1 to 0, DAC Channel x updates to Register A. When TBx changes from 0 to 1, DAC Channel x updates to Register B.	All 0	R/W

## COMMAND ADDRESSES

Table 43. Write Commands (Continued)

Command No.	Instruction	Command Address	Bit(s)	Bit Name	Description	Reset Value	R/W
11	Write toggle/dither enable register	0x74	[23:8]	EN15 to EN0	Toggle/dither enable bit register. ENx controls DAC Channel x. Set ENx to enable toggle/dither functionality. Reset ENx to disable toggle/dither functionality.	All 0	R/W
12	Write mux control register	0x75	18	ENMUX	Enable mux. Mux is enabled when ENMUX = 1, and mux is disabled when ENMUX = 0.	0	W
			[17:8]	M8 to M0	Mux address register for accessing signals at the MUX pin. See Table 26 for address to signal assignment.	All 0	W
13	Write fault register	0x76	10	TSF	Thermal shutdown bit.	0	R/W
			9	CKF	Clock integrity fault bit.	0	R/W
			8	CF	Command integrity fault bit.	0	R/W
14	Write code to all DAC channels	0x78	[23:8]	D15 to D0	16-bit DAC code written to all channels for LTC2688-16.	All 0	W
			[23:12]	D11 to D0	12-bit DAC code written to all channels for LTC2688-12.		
15	Write code to all DAC channels, update all DAC channels	0x79	[23:8]	D15 to D0	16-bit DAC code written to all channels and all channels are updated for LTC2688-16.	All 0	W
			[23:12]	D11 to D0	12-bit DAC code written to all channels and all channels are updated for LTC2688-12.		
16	Write channel settings to all DAC channels	0x7A	[19:8]		See Command 1 for the bit structure.	All 0	R/W
17	Write channel settings to all DAC channels, update all DAC channels	0x7B	[19:8]		See Command 1 for the bit structure.	All 0	R/W
18	Update all DAC channels	0x7C			Updates the DAC register for all channels.	0x0	R/W

Table 44. Read Commands

Command No.	Command/Address	Description
20	0x8, A[3:0]	Read offset and gain adjusted code of DAC Channel x
21	0x9, A[3:0]	Read channel settings of DAC Channel x
22	0xA, A[3:0]	Read offset adjust of DAC Channel x
23	0xB, A[3:0]	Read gain adjust of DAC Channel x
24	0xF0	Read configuration register
25	0xF1	Read power-down status
26	0xF2	Read A/B select register
27	0xF3	Read software toggle bit register
28	0xF4	Read toggle/dither enable register
29	0xF5	Read mux control register
30	0xF6	Read fault register
31	0xF7	Read thermal shutdown status register
32	0xFF	No operation

OUTLINE DIMENSIONS

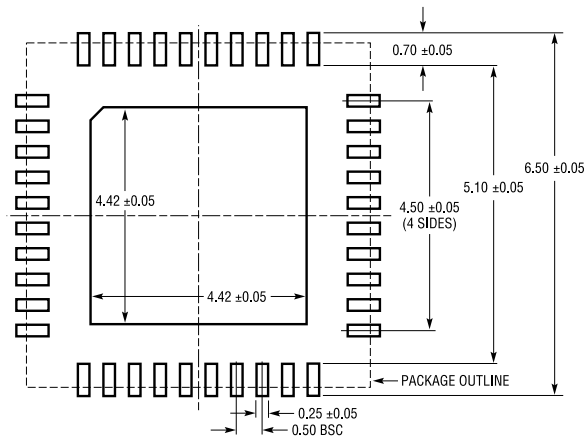

RECOMMENDED SOLDER PAD PITCH AND DIMENSIONS  
APPLY SOLDER MASK TO AREAS THAT ARE NOT SOLDERED

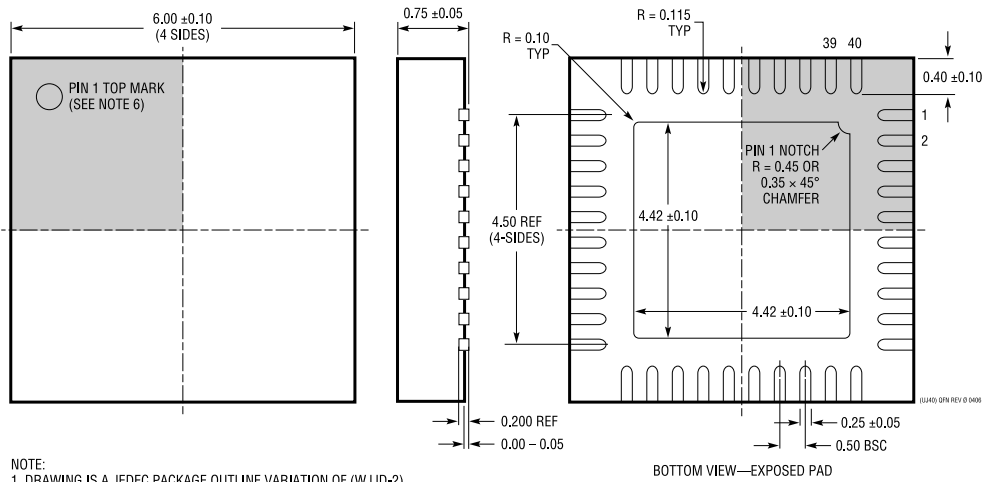

- NOTE:
1. DRAWING IS A JEDEC PACKAGE OUTLINE VARIATION OF (WJJD-2)
  2. DRAWING NOT TO SCALE
  3. ALL DIMENSIONS ARE IN MILLIMETERS
  4. DIMENSIONS OF EXPOSED PAD ON BOTTOM OF PACKAGE DO NOT INCLUDE MOLD FLASH. MOLD FLASH, IF PRESENT, SHALL NOT EXCEED 0.20mm ON ANY SIDE, IF PRESENT
  5. EXPOSED PAD SHALL BE SOLDER PLATED
  6. SHADED AREA IS ONLY A REFERENCE FOR PIN 1 LOCATION ON THE TOP AND BOTTOM OF PACKAGE

**Figure 61. 40-Lead Lead Frame Chip Scale Package [LFCSP]  
6 mm × 6 mm Body and 0.75 mm Package Height  
05-08-1728  
Dimensions shown in millimeters**

OUTLINE DIMENSIONS

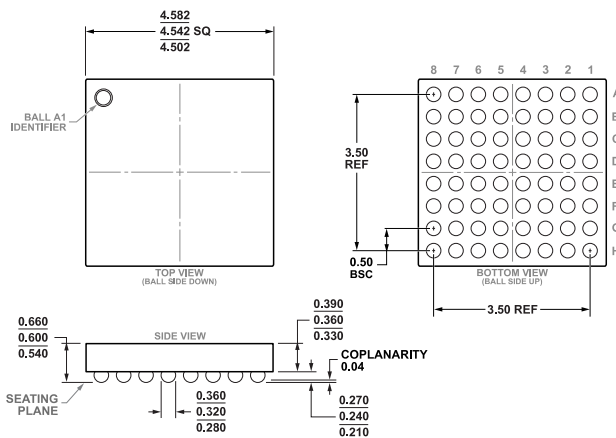

Figure 62. 64-Ball Wafer Level Chip Scale Package [WLCSF] (CB-64-5)

Dimensions shown in millimeters

Updated: November 17, 2022

ORDERING GUIDE

Model <sup>1</sup>	Temperature Range	Package Description	Packing Quantity	Package Option
LTC2688CUJ-12#PBF	0°C to +70°C	LFCSP:LEADFRM CHIP SCALE		05-08-1728
LTC2688CUJ-12#TRPBF	0°C to +70°C	LFCSP:LEADFRM CHIP SCALE	Reel, 2000	05-08-1728
LTC2688CUJ-16#PBF	0°C to +70°C	LFCSP:LEADFRM CHIP SCALE		05-08-1728
LTC2688CUJ-16#TRPBF	0°C to +70°C	LFCSP:LEADFRM CHIP SCALE	Reel, 2000	05-08-1728
LTC2688HCB-12#TRPBF	-40°C to +125°C	CHIPS W/SOLDER BUMPS/WLCSF	Reel, 5000	CB-64-5
LTC2688HCB-16#TRPBF	-40°C to +125°C	CHIPS W/SOLDER BUMPS/WLCSF	Reel, 5000	CB-64-5
LTC2688HUJ-12#PBF	-40°C to +125°C	LFCSP:LEADFRM CHIP SCALE		05-08-1728
LTC2688HUJ-12#TRPBF	-40°C to +125°C	LFCSP:LEADFRM CHIP SCALE	Reel, 2000	05-08-1728
LTC2688HUJ-16#PBF	-40°C to +125°C	LFCSP:LEADFRM CHIP SCALE		05-08-1728
LTC2688HUJ-16#TRPBF	-40°C to +125°C	LFCSP:LEADFRM CHIP SCALE	Reel, 2000	05-08-1728
LTC2688IUJ-12#PBF	-40°C to +85°C	LFCSP:LEADFRM CHIP SCALE		05-08-1728
LTC2688IUJ-12#TRPBF	-40°C to +85°C	LFCSP:LEADFRM CHIP SCALE	Reel, 2000	05-08-1728
LTC2688IUJ-16#PBF	-40°C to +85°C	LFCSP:LEADFRM CHIP SCALE		05-08-1728
LTC2688IUJ-16#TRPBF	-40°C to +85°C	LFCSP:LEADFRM CHIP SCALE	Reel, 2000	05-08-1728

<sup>1</sup> All models are RoHS compliant parts.

EVALUATION BOARDS

Model <sup>1</sup>	Description
DC2873A-B	LTC2688-16 Evaluation Board (LFCSP Package)
DC2873A-C	LTC2688-12 Evaluation Board (LFCSP Package)

<sup>1</sup> The DC2873A-B and DC2873A-C are RoHS compliant.

## Looking for pricing, stock, or lifecycle information?

Click below to explore more details on WIN SOURCE:

- ⊖ [View LTC2688HUU-16#TRPBF on WIN SOURCE](#)
- ⊖ [Analog Devices Inc. Information](#)

## Optimize Your Supply Chain with WIN SOURCE Solutions

- ✓ Global Sourcing Solution
- ✓ Obsolete Management
- ✓ Cost Control Management
- ✓ Shortage Management
- ✓ Alternative Solution
- ✓ Excess Inventory Management