



**THE DATASHEET OF
HMC245QS16TR**





GaAs MMIC SP3T Non-REFLECTIVE SWITCH, DC - 3.5 GHz

Typical Applications

The HMC245AQS16 / 245AQS16E is ideal for:

- Basestation Infrastructure
- CATV / DBS
- Wireless Local Loop
- Test Equipment

Features

- Low Insertion Loss: 0.7 dB @ 2.0 GHz
- Non-Reflective Design
- Integrated 2:3 TTL Decoder
- "All Off" Isolation State
- Single Positive Supply: Vdd = +5V
- 16 Lead QSOP SMT Package

Functional Diagram

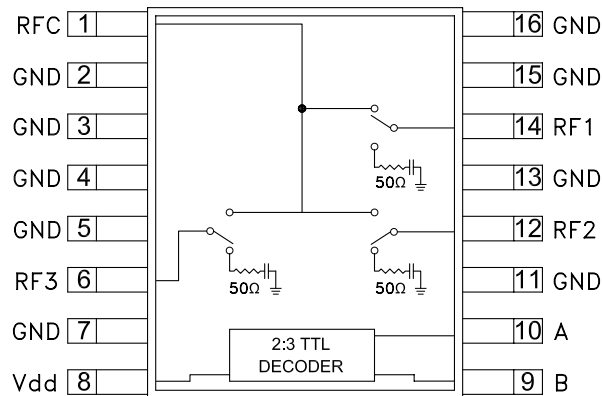

General Description

The HMC245AQS16E is a low cost non-reflective SP3T switches in 16-lead QSOP surface mount packages. Covering DC to 3.5 GHz, the switch offers 30 to 40 dB isolation and a low insertion loss of 0.7 dB. A 2:3 TTL/CMOS compatible decoder is integrated on the switch requiring only 2 control lines and a single +5V bias to select each path, replacing 6 control lines normally required by GaAs SP3T switches.

Electrical Specifications,

$T_A = +25^\circ \text{C}$, For TTL Control and Vdd = +5V in a 50 Ohm System

Parameter	Frequency	Min.	Typ.	Max.	Units
Insertion Loss	DC - 2.0 GHz		0.7	1.0	dB
	DC - 3.0 GHz		0.8	1.3	dB
	DC - 3.5 GHz		1.1	1.5	dB
Isolation	DC - 1.0 GHz	40	46		dB
	DC - 2.0 GHz	35	42		dB
	DC - 2.5 GHz	31	40		dB
	DC - 3.5 GHz	26	32		dB
Return Loss	"On State"	DC - 1.5 GHz	23		dB
		DC - 3.5 GHz	17		dB
Return Loss RF1 - 3	"Off State"	0.3 - 3.5 GHz	12		dB
		0.5 - 3.5 GHz	15		dB
Input Power for 1 dB Compression	0.3 - 2.5 GHz	26	29		dBm
	0.3 - 3.5 GHz	25	28		dBm
Input Third Order Intercept (Two-tone Input Power = +10 dBm each tone)	0.3 - 2.5 GHz	44	48		dBm
	0.3 - 3.5 GHz	40	44		dBm
Switching Characteristics	0.3 - 3.5 GHz	tRISE, tFALL (10/90% RF)	40		ns
		tON, tOFF (50% CTL to 10/90% RF)	150		ns



GaAs MMIC SP3T Non-REFLECTIVE SWITCH, DC - 3.5 GHz

SWITCHES - MULTI-THROW - SMT

Insertion Loss vs. Temperature

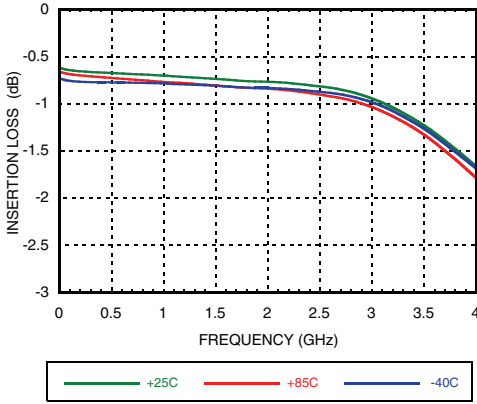

Isolation

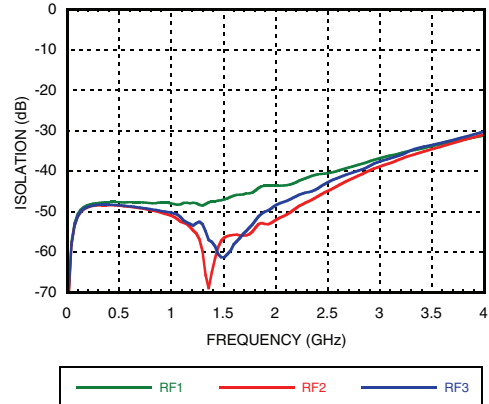

Return Loss

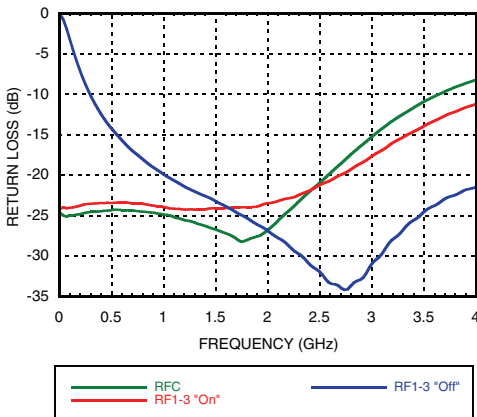

Off State Isolation

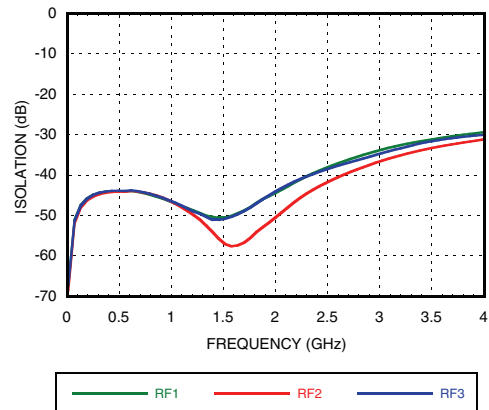

0.1 and 1 dB Input Compression Point

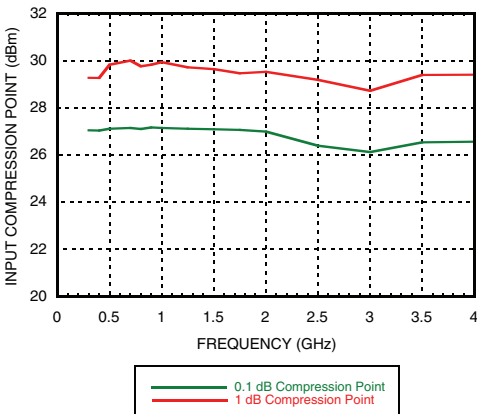

Input Third Order Intercept Point

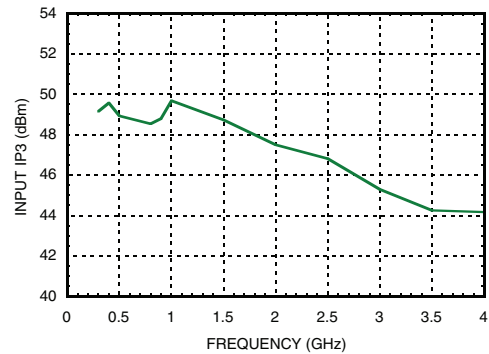

**GaAs MMIC SP3T Non-REFLECTIVE
SWITCH, DC - 3.5 GHz**
Bias Voltage & Current

Vdd Range= +5 Vdc ±10%		
Vdd (Vdc)	Idd (Typ) (mA)	Idd (Max) (mA)
+5	2.2	6.0

TTL/CMOS Control Voltages

State	Bias Condition
Low	0 to +0.8 Vdc @ 0.2 μ A Typ.
High	+2.0 to +5 Vdc @ 35 μ A Typ.

Truth Table

Control Input		Signal Path State
A	B	RF COM to:
Low	Low	RF1
High	Low	RF2
Low	High	RF3
High	High	All Off

GaAs MMIC SP3T Non-REFLECTIVE SWITCH, DC - 3.5 GHz



Absolute Maximum Ratings

Bias Voltage Range (Port Vdd)	+7.0 Vdc
Control Voltage Range (A & B)	-0.5V to Vdd +1 Vdc
Channel Temperature	150 °C
Thermal Resistance	
Insertion Loss Path	150 °C/W
Terminated Path	297 °C/W
Storage Temperature	-65 to +150 °C
Operating Temperature	-40 to +85 °C
Maximum Input Power Vdd = +5 Vdc	
Insertion Loss Path	+28.5 dBm
Terminated Path	+23.4 dBm
ESD Sensitivity (HBM)	Class 1A



ELECTROSTATIC SENSITIVE DEVICE
OBSERVE HANDLING PRECAUTIONS

Outline Drawing

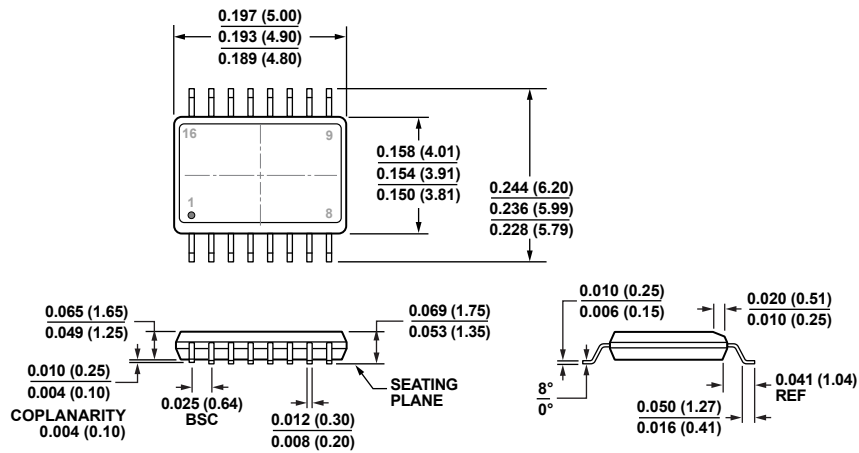

COMPLIANT TO JEDEC STANDARDS MO-137-AB
CONTROLLING DIMENSIONS ARE IN INCHES; MILLIMETER DIMENSIONS (IN PARENTHESES) ARE ROUNDED-OFF INCH EQUIVALENTS FOR REFERENCE ONLY AND ARE NOT APPROPRIATE FOR USE IN DESIGN.

16-Lead Shrink Small Outline Package [QSOP]
(RQ-16)
Dimensions shown in inches and (millimeters)

08-12-2014-A

Package Information

Part Number	Package Body Material	Leadframe Plating	MSL Rating	Package Marking [2]
HMC245AQS16E	RoHS-compliant Low Stress Injection Molding Plastic Silica and Silicon Impregnated	100% Matte Tin	MSL1 [1]	H245A XXXX

[1] Max peak reflow temperature of 260 °C

[2] 4-Digit lot number XXXX

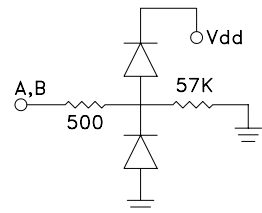

**GaAs MMIC SP3T Non-REFLECTIVE
SWITCH, DC - 3.5 GHz**
Pin Descriptions

Pin Number	Function	Description	Interface Schematic
1, 6, 12, 14	RF3, RF2, RF1, RFC	This pin is DC coupled and matched to 50 Ohms. Blocking capacitors are required.	
2 - 5, 7, 11, 13, 15, 16	GND	This pin must be connected to PCB RF ground to maximize isolation.	
8	Vdd	Supply Voltage +5 Vdc ±10%	
9	B	See truth table and control voltage table.	
10	A	See truth table and control voltage table.	

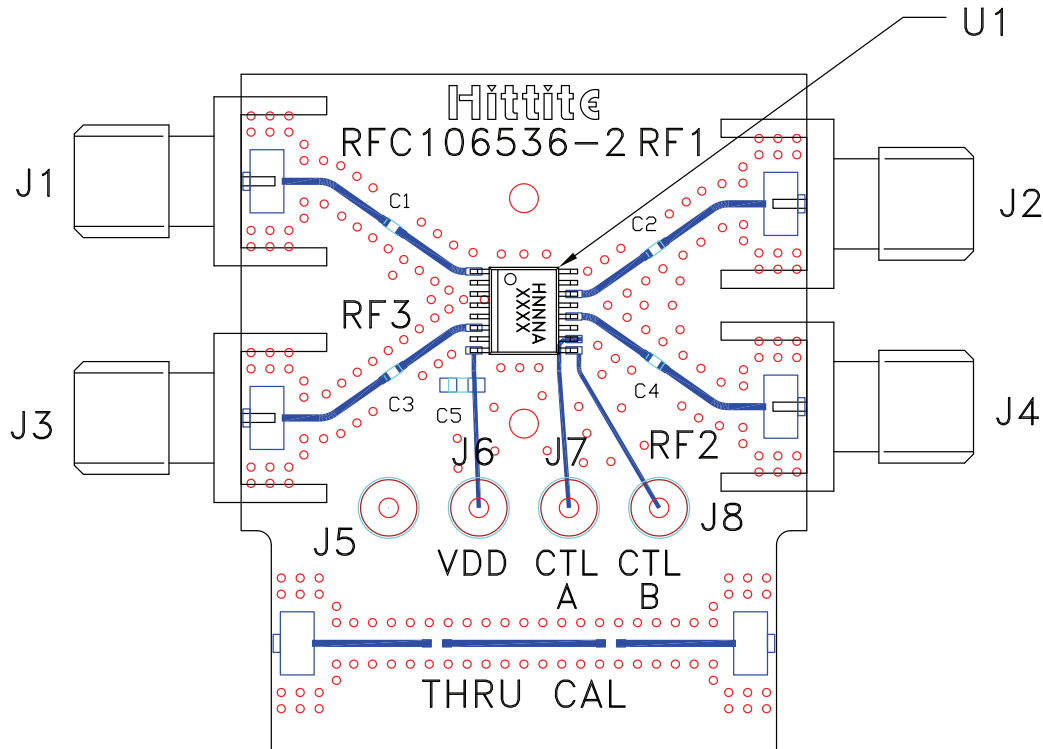

**GaAs MMIC SP3T Non-REFLECTIVE
SWITCH, DC - 3.5 GHz**

Evaluation PCB



List of Materials for Evaluation PCB EV1HMC245AQS16 [1]

Item	Description
J1 - J4	PCB Mount SMA RF Connector
J5 - J8	DC Pin
C1 - C4	100 pF Capacitor, 0402 Pkg.
C5	10k pF Capacitor, 0603 Pkg.
U1	HMC245AQS16 / 245AQS16E SP3T Switch
PCB [2]	106536 Evaluation PCB

The circuit board used in the application should be generated with proper RF circuit design techniques. Signal lines at the RF port should have 50 ohm impedance and the package ground leads should be connected directly to the ground plane similar to that shown above. The evaluation circuit board shown above is available from Analog Devices upon request.

[1] Reference this number when ordering complete evaluation PCB

[2] Circuit Board Material: Rogers 4350

Looking for pricing, stock, or lifecycle information?

Click below to explore more details on WIN SOURCE:

 [View HMC245QS16TR on WIN SOURCE](#)

 [Analog Devices Inc. Information](#)

Optimize Your Supply Chain with WIN SOURCE Solutions

-  Global Sourcing Solution
-  Obsolete Management
-  Cost Control Management
-  Shortage Management
-  Alternative Solution
-  Excess Inventory Management