



**THE DATASHEET OF  
5.0SMDJ36CA/TR13**



# DATA SHEET

## TRANSIENT VOLTAGE SUPPRESSORS

### AC/DC POWER SUPPLY

5.0SMDJ-AT series

RoHS compliant & Halogen free



Product specification— June 30, 2023 V.4



## Transient Voltage Suppressors (TVS) Data Sheet

### Features

- For surface mounted applications in order to optimize board space
- Low profile package
- Built-in strain relief
- Glass passivated junction
- Low inductance
- Excellent clamping capability
- 5000W peak pulse power capability at 10/1000 $\mu$ s waveform, repetition rate (duty cycle): 0.01%
- Fast response time
- Typical  $I_R$  less than 2 $\mu$ A above 22V
- High Temperature soldering: 260 $^{\circ}$ C/10 seconds at terminals
- Plastic package has underwriters laboratory flammability 94V-0
- Meets MSL level 1, per J-STD-020
- Safety certification: UL
- AEC-Q101 qualified
- IEC61000-4-2 ESD 30KV Air, 30KV contact compliance



### Mechanical Data

- Case: JEDEC DO-214AB. Molded plastic over glass passivated junction
- Terminal: Tin plated, solderable per MIL-STD-750, Method 2026
- Polarity: Color band denotes cathode except bi-directional models
- Standard Packaging: 16mm tape (EIA STD RS-481)
- Weight: 0.30g

### Applications

- I/O interface
- AC/DC power supply
- Low frequency signal transmission line (RS232, RS485, etc.)

### Maximum Ratings and Characteristics

Ratings at 25 $^{\circ}$ C ambient temperature unless otherwise specified.

Rating	Symbol	Value	Units
Peak pulse power dissipation at 10/1000 $\mu$ s waveform (Note1, Note2, Fig.1)	$P_{PPM}$	Minimum 5000	Watts
Peak pulse current of at 10/1000 $\mu$ s waveform (Note 1, Fig.3)	$I_{PPM}$	See Table	Amps
Steady state power dissipation at $T_A=50^{\circ}$ C (Fig.5)	$P_{M(AV)}$	6.5	Watts
Peak forward surge current, 8.3ms single half sine-wave superimposed on rated load, (JEDEC Method) (Note3, Fig.6)	$I_{FSM}$	300	Amps
Operating junction and Storage Temperature Range.	$T_J, T_{STG}$	-55 to +150	$^{\circ}$ C
Typical thermal resistance junction to lead	$R_{\theta JL}$	15	$^{\circ}$ C/W
Typical thermal resistance junction to ambient	$R_{\theta JA}$	75	$^{\circ}$ C/W

Notes: 1. Non-repetitive current pulse, per Fig.3 and derated above  $T_A=25^{\circ}$ C per Fig.2.

2. Mounted on 8.0mm $\times$ 8.0mm copper pads to each terminal.

3. 8.3ms single half sine-wave, or equivalent square wave, duty cycle=4 pulses per minutes maximum.

**Dimensions (SMC/DO-214AB)**

<p>Product:</p> <p>Pad:</p>	Symbol	Millimeters		Inches	
		Min.	Max.	Min.	Max.
	L	6.60	7.11	0.260	0.280
	D	5.59	6.22	0.220	0.245
	D1	2.90	3.20	0.114	0.126
	T	7.75	8.13	0.305	0.320
	T1	0.76	1.52	0.030	0.060
	d	-	0.203	-	0.008
	H	2.20	2.80	0.087	0.110
	H1	2.06	2.62	0.079	0.103

**Electrical Characteristics (T<sub>A</sub>=25°C)**

Part Number		Device Marking Code		Reverse Stand-Off Voltage	Breakdown Voltage @I <sub>T</sub>	Test Current	Maximum Clamping Voltage @I <sub>PP</sub>	Peak Pulse Current	Reverse Leakage @V <sub>RWM</sub>
Unidirectional	Bidirectional	UNI	BI	V <sub>RWM</sub> (V)	V <sub>BR</sub> (V)	I <sub>T</sub> (mA)	V <sub>C</sub> (V)	I <sub>PP</sub> (A)	I <sub>R</sub> (μA)
5.0SMDJ11A-AT	5.0SMDJ11CA-AT	5PEN	5BEN	11.0	12.20~13.50	10	18.2	275.00	800
5.0SMDJ12A-AT	5.0SMDJ12CA-AT	5PEP	5BEP	12.0	13.30~14.70	10	19.9	252.00	800
5.0SMDJ13A-AT	5.0SMDJ13CA-AT	5PEQ	5BEQ	13.0	14.40~15.90	10	21.5	233.00	500
5.0SMDJ14A-AT	5.0SMDJ14CA-AT	5PER	5BER	14.0	15.60~17.20	10	23.2	216.00	200
5.0SMDJ15A-AT	5.0SMDJ15CA-AT	5PES	5BES	15.0	16.70~18.50	1	24.4	205.00	100
5.0SMDJ16A-AT	5.0SMDJ16CA-AT	5PET	5BET	16.0	17.80~19.70	1	26.0	193.00	50
5.0SMDJ17A-AT	5.0SMDJ17CA-AT	5PEU	5BEU	17.0	18.90~20.90	1	27.6	181.00	20
5.0SMDJ18A-AT	5.0SMDJ18CA-AT	5PEV	5BEV	18.0	20.00~22.10	1	29.2	172.00	10
5.0SMDJ20A-AT	5.0SMDJ20CA-AT	5PEW	5BEW	20.0	22.20~24.50	1	32.4	155.00	5
5.0SMDJ22A-AT	5.0SMDJ22CA-AT	5PEX	5BEX	22.0	24.40~26.90	1	35.5	141.00	5
5.0SMDJ24A-AT	5.0SMDJ24CA-AT	5PEZ	5BEZ	24.0	26.70~29.50	1	38.9	129.00	2
5.0SMDJ26A-AT	5.0SMDJ26CA-AT	5PFE	5BFE	26.0	28.90~31.90	1	42.1	119.00	2

**Transient Voltage Suppressors**

5.0SMDJ-AT

Part Number		Device Marking Code		Reverse Stand-Off Voltage	Breakdown Voltage @I <sub>T</sub>	Test Current	Maximum Clamping Voltage @I <sub>PP</sub>	Peak Pulse Current	Reverse Leakage @V <sub>RWM</sub>
Unidirectional	Bidirectional	UNI	BI	V <sub>RWM</sub> (V)	V <sub>BR</sub> (V)	I <sub>T</sub> (mA)	V <sub>C</sub> (V)	I <sub>PP</sub> (A)	I <sub>R</sub> (μA)
5.0SMDJ28A-AT	5.0SMDJ28CA-AT	5PFG	5BFG	28.0	31.10~34.40	1	45.4	110.00	2
5.0SMDJ30A-AT	5.0SMDJ30CA-AT	5PFK	5BFK	30.0	33.30~36.80	1	48.4	103.00	2
5.0SMDJ33A-AT	5.0SMDJ33CA-AT	5PFM	5BFM	33.0	36.70~40.60	1	53.3	93.90	2
5.0SMDJ36A-AT	5.0SMDJ36CA-AT	5PFP	5BFP	36.0	40.00~44.20	1	58.1	86.10	2
5.0SMDJ40A-AT	5.0SMDJ40CA-AT	5PFR	5BFR	40.0	44.40~49.10	1	64.5	77.60	2
5.0SMDJ43A-AT	5.0SMDJ43CA-AT	5PFT	5BFT	43.0	47.80~52.80	1	69.4	72.10	2
5.0SMDJ45A-AT	5.0SMDJ45CA-AT	5PFV	5BFV	45.0	50.00~55.30	1	72.7	68.80	2
5.0SMDJ48A-AT	5.0SMDJ48CA-AT	5PFX	5BFX	48.0	53.30~58.90	1	77.4	64.70	2
5.0SMDJ51A-AT	5.0SMDJ51CA-AT	5PFZ	5BFZ	51.0	56.70~62.70	1	82.4	60.70	2
5.0SMDJ54A-AT	5.0SMDJ54CA-AT	5PGE	5BGE	54.0	60.00~66.30	1	87.1	57.50	2
5.0SMDJ58A-AT	5.0SMDJ58CA-AT	5PGG	5BGG	58.0	64.40~71.20	1	93.6	53.50	2
5.0SMDJ60A-AT	5.0SMDJ60CA-AT	5PGK	5BGK	60.0	66.70~73.70	1	96.8	51.70	2
5.0SMDJ64A-AT	5.0SMDJ64CA-AT	5PGM	5BGM	64.0	71.10~78.60	1	103.0	48.60	2
5.0SMDJ70A-AT	5.0SMDJ70CA-AT	5PGP	5BGP	70.0	77.80~86.00	1	113.0	44.30	2
5.0SMDJ75A-AT	5.0SMDJ75CA-AT	5PGR	5BGR	75.0	83.30~92.10	1	121.0	41.40	2
5.0SMDJ78A-AT	5.0SMDJ78CA-AT	5PGT	5BGT	78.0	86.70~95.80	1	126.0	39.70	2
5.0SMDJ85A-AT	5.0SMDJ85CA-AT	5PGV	5BGV	85.0	94.40~104.00	1	137.0	36.50	2
5.0SMDJ90A-AT	5.0SMDJ90CA-AT	5PGX	5BGX	90.0	100.00~111.00	1	146.0	34.30	2
5.0SMDJ100A-AT	5.0SMDJ100CA-AT	5PGZ	5BGZ	100.0	111.00~123.00	1	162.0	30.90	2
5.0SMDJ110A-AT	5.0SMDJ110CA-AT	5PHE	5BHE	110.0	122.00~135.00	1	177.0	28.30	2
5.0SMDJ120A-AT	5.0SMDJ120CA-AT	5PHG	5BHG	120.0	133.00~147.00	1	193.0	26.00	2
5.0SMDJ130A-AT	5.0SMDJ130CA-AT	5PHK	5BHK	130.0	144.00~159.00	1	209.0	24.00	2
5.0SMDJ150A-AT	5.0SMDJ150CA-AT	5PHM	5BHM	150.0	167.00~185.00	1	243.0	20.60	2
5.0SMDJ160A-AT	5.0SMDJ160CA-AT	5PHP	5BHP	160.0	178.00~197.00	1	259.0	19.30	2
5.0SMDJ170A-AT	5.0SMDJ170CA-AT	5PHR	5BHR	170.0	189.00~209.00	1	275.0	18.20	2

Ratings and Characteristic Curves ( $T_A=25^\circ\text{C}$  unless otherwise noted)

Figure 1. Peak Pulse Power Rating Curve

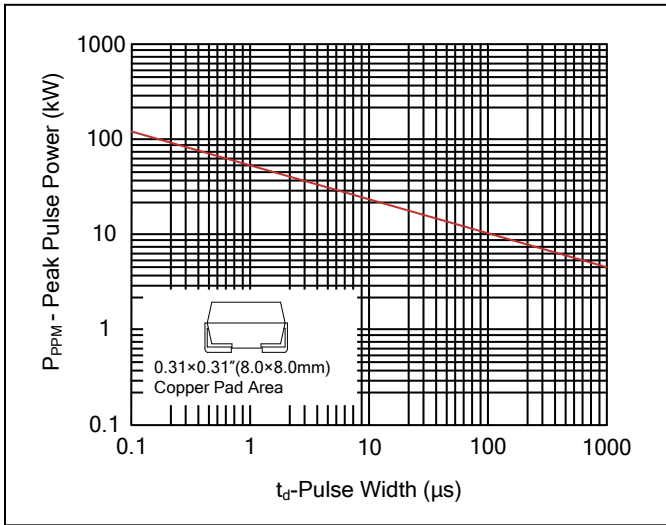

Figure 2. Pulse Derating Curve

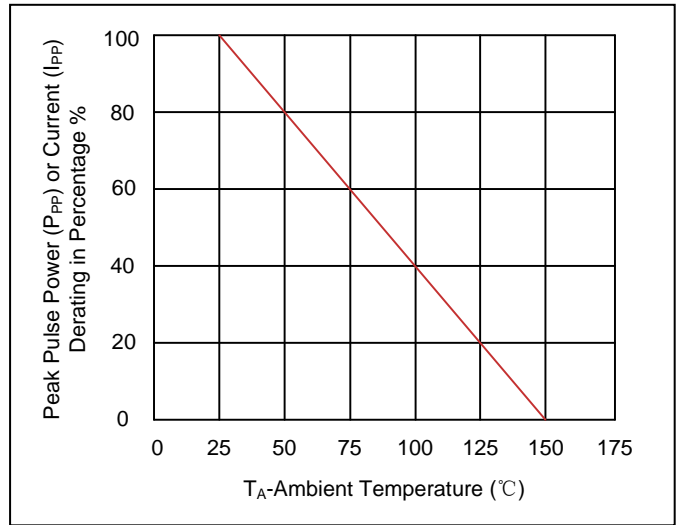

Figure 3. Pulse Waveform

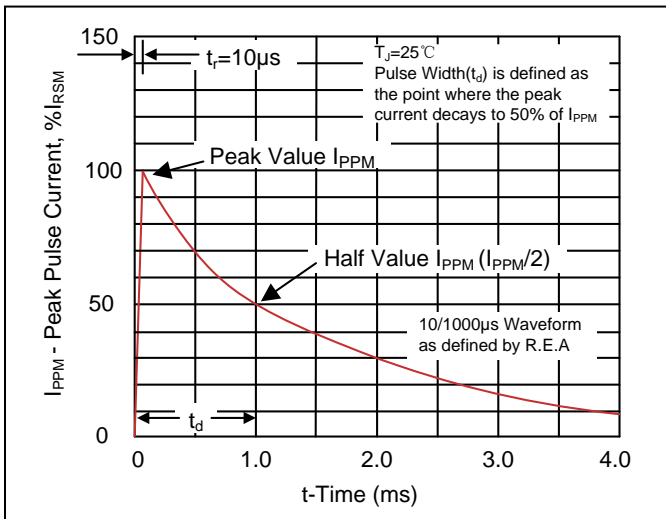

Figure 4. Typical Junction Capacitance

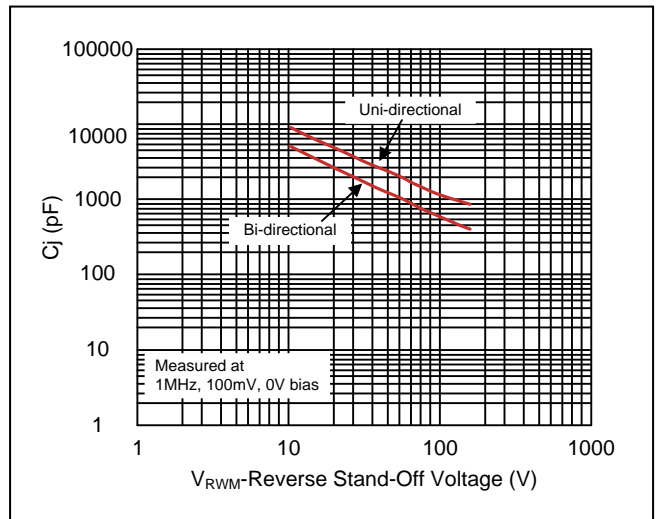

Figure 5. Steady State Power Dissipation Derating Curve

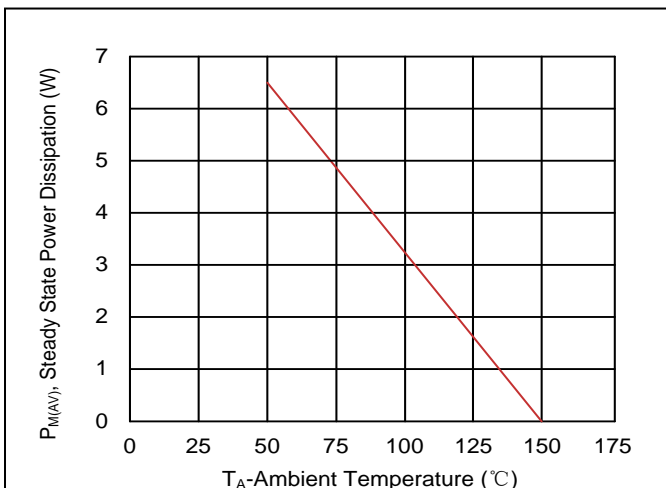
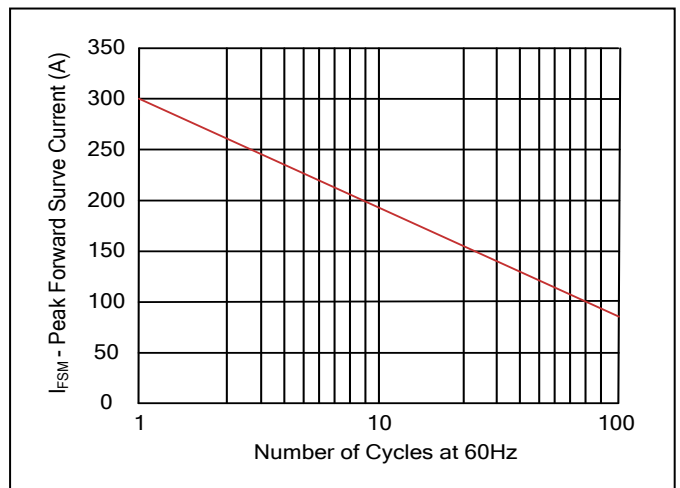
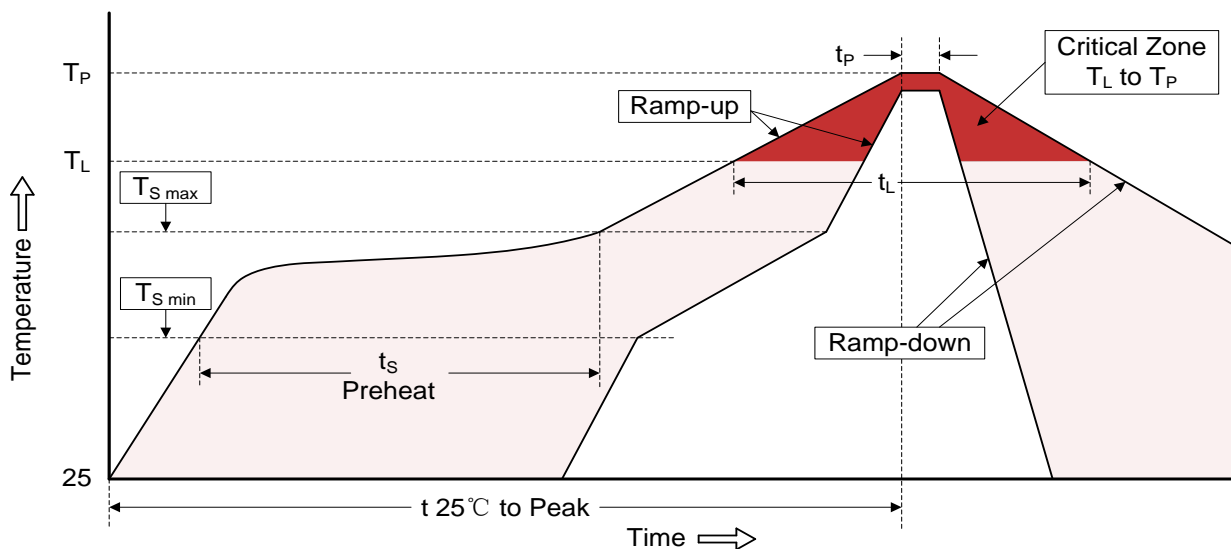

Figure 6. Maximum Non-Repetitive Forward Surge Current Uni-Directional Only



**Recommended Soldering Conditions**

Reflow Soldering



Recommended Conditions

Profile Feature	Pb-Free Assembly
Average ramp-up rate (TL to TP)	3°C/second max.
Preheat -Temperature Min (TSmin) -Temperature Max (TSmax) -Time (min to max) (ts)	150°C 200°C 60-180 seconds
TSmax to TL -Ramp-up Rate	3°C/second max.
Time maintained above: -Temperature (TL) -Time (tL)	217°C 60-150 seconds
Peak Temperature (TP)	260°C
Time within 5°C of actual Peak Temperature (tP)	20-40 seconds
Ramp-down Rate	6°C/second max.
Time 25°C to Peak Temperature	8 minutes max.

**Marking Code**

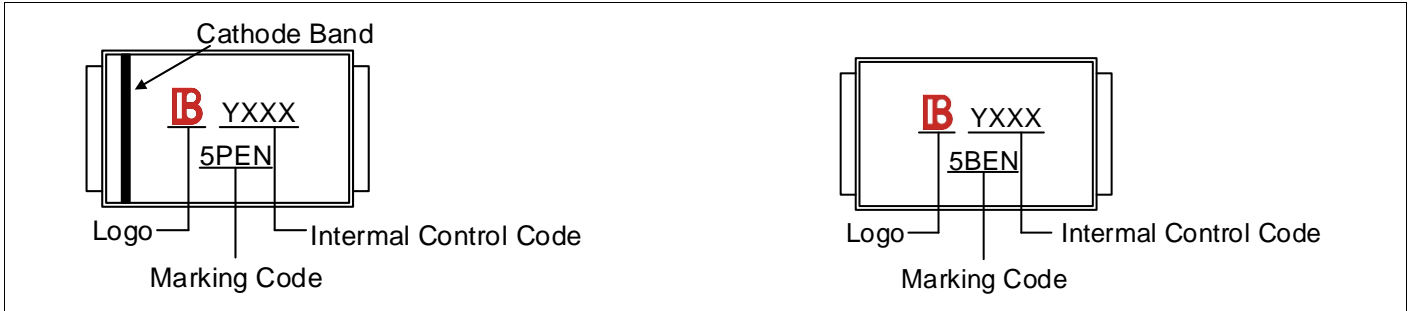

**Part Number Code**

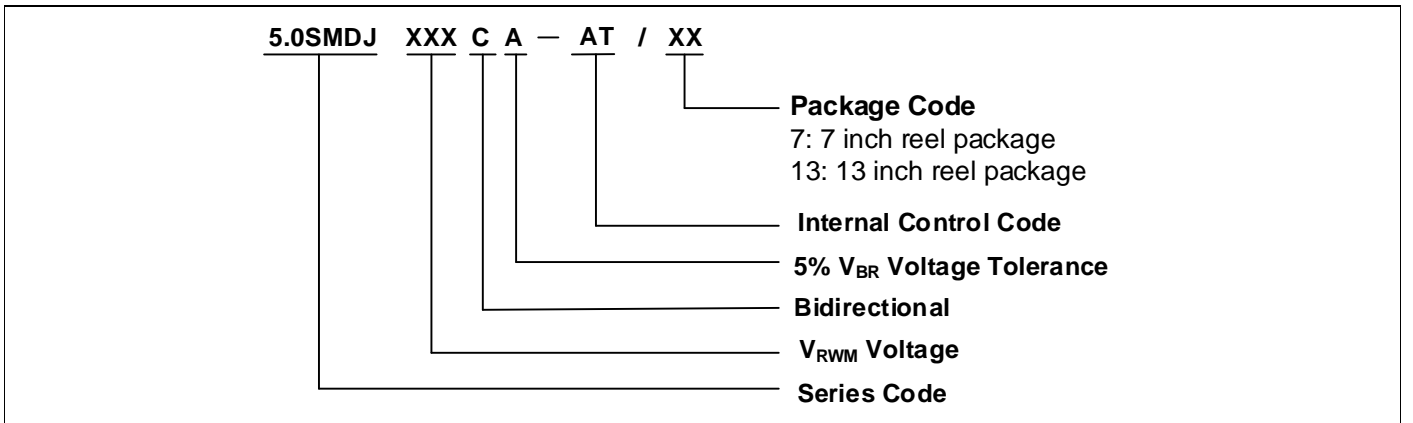

**Ordering Code for Different Package**

7 inch reel package: Add suffix “/7” at the end of the part number, such as 5.0SMDJXXXCA-AT/7

13 inch reel package: Add suffix “/13” at the end of the part number, such as 5.0SMDJXXXCA-AT/13

**Packaging**

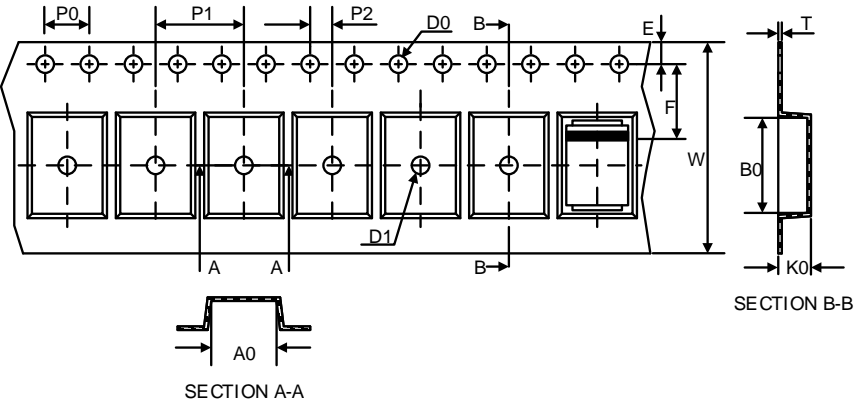
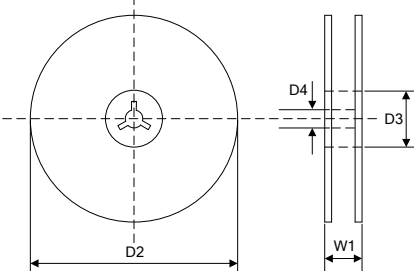
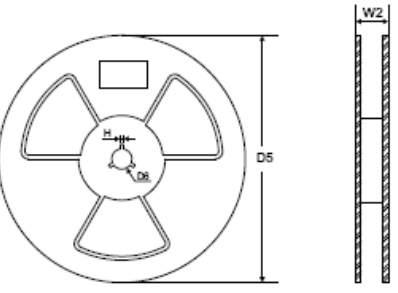
Tape	Symbol	Dimension (mm)	
	W	16.00±0.20	
	P0	4.00±0.10	
	P1	8.00±0.10	
	P2	2.00±0.10	
	D0	Φ1.5±0.10	
	D1	Φ1.5±0.10	
	E	1.75±0.10	
	F	7.50±0.10	
	A0	6.27±0.10	
	B0	8.30±0.10	
	K0	3.15±0.15	
	T	0.30±0.05	
	<p>7" Reel</p> 	D2	Φ178.0±2.0
		D3	Φ50.0Min.
D4		Φ13.0±0.5	
W1		20.0±2.0	
Quantity: 500PCS			
<p>13" Reel</p> 	D5	Φ330.0±2.0	
	D6	Φ13.5±0.5	
	H	2.5±1.0	
	W2	20.0±2.0	
	Quantity: 3000PCS		

## LEGAL DISCLAIMER

YAGEO, its distributors and agents (collectively, “YAGEO”), hereby disclaims any and all liabilities for any errors, inaccuracies or incompleteness contained in any product related information, including but not limited to product specifications, datasheets, pictures and/or graphics. YAGEO may make changes, modifications and/or improvements to product related information at any time and without notice.



YAGEO makes no representation, warranty, and/or guarantee about the fitness of its products for any particular purpose or the continuing production of any of its products. To the maximum extent permitted by law, YAGEO disclaims (i) any and all liability arising out of the application or use of any YAGEO product, (ii) any and all liability, including without limitation special, consequential or incidental damages, and (iii) any and all implied warranties, including warranties of fitness for a particular purpose, non-infringement and merchantability.

YAGEO products are designed for general purpose applications under normal operation and usage conditions. Please contact YAGEO for the applications listed below which require especially high reliability for the prevention of defects which might directly cause damage to the third party's life, body or property: Aerospace equipment (artificial satellite, rocket, etc.), Atomic energy-related equipment, Aviation equipment, Disaster prevention equipment, crime prevention equipment, Electric heating apparatus, burning equipment, Highly public information network equipment, data-processing equipment, Medical devices, Military equipment, Power generation control equipment, Safety equipment, Traffic signal equipment, Transportation equipment and Undersea equipment, or for any other application or use in which the failure of YAGEO products could result in personal injury or death, or serious property damage. Particularly **YAGEO Corporation and its affiliates do not recommend the use of commercial or automotive grade products for high reliability applications or manned space flight.**

Information provided here is intended to indicate product specifications only. YAGEO reserves all the rights for revising this content without further notification, as long as products are unchanged. Any product change will be announced by PCN.

## Looking for pricing, stock, or lifecycle information?

Click below to explore more details on WIN SOURCE:

-  [View 5.0SMDJ36CA/TR13 on WIN SOURCE](#)
-  [Yageo Information](#)

## Optimize Your Supply Chain with WIN SOURCE Solutions

-  Global Sourcing Solution
-  Obsolete Management
-  Cost Control Management
-  Shortage Management
-  Alternative Solution
-  Excess Inventory Management