



**THE DATASHEET OF
DF1B-12DP-2.5DSA(01)**



DF1B Series

2.5mm Pitch Connector for Discrete Wire Connection (UL/CSA Standard Certified Product)

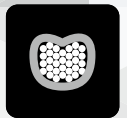

Jun.1.2024 Copyright 2024 HIROSE ELECTRIC CO., LTD. All Rights Reserved.



Features

1. Wide Variety

Each of the "wire-to-board" and "in-line" types has single and double row variations, and both tin and gold plating are available as standard. (Refer to the applicable combination diagram on the next page.)

Applications

Business equipment including copy machines and printers.

Product Specifications

Rated Current (Note 1)	No of Pos.	20 AWG	22 to 24 AWG	26 AWG	28 AWG	30 AWG	Operating Temperature (Note 2)	-35 to +85°C
	2	5A/pin	3A/pin	2A/pin	1A/pin	0.5A/pin	Operating Humidity Range (Note 3)	40 to 80%
	3 to 40	3A/pin	3A/pin	2A/pin	1A/pin	0.5A/pin	Storage Temperature Range (Note4)	-10 to +60°C
Rated Voltage	250V AC/DC						Storage Humidity Range (Note 4)	40 to 70%

UL, CSA Current Rating (Note 1)	20-22 AWG	24-28 AWG	30 AWG
	3A/pin	1A/pin	0.5A/pin
UL, CSA Voltage Rating	30V AC/DC		

UL CSA Safety File No. UL : E52653/CSA : LR95109

Note 1 : The rated current varies based on cable size used. The current rating of only the header is 3A.

Note 2 : Includes temperature rise caused by current flow.

Note 3 : Please use without condensation.

Note 4 : Applicable to unused items in packaged state.

Note 5 : Information contained in this catalog represents general requirements for this Series. Contact us for the drawings and specifications for a specific part number shown.

Item	Specification	Condition
Insulation Resistance	1000M Ω Min	500V DC
Withstanding Voltage	No flashover or insulation breakdown.	650V AC for 1 min.
Contact Resistance	30m Ω Max	100mA
Single Insertion/Extraction Force	0.44N(45gf) Min., 4.4N(450gf) Max.	Measure at the square steel pin of 0.635 \pm 0.002mm
Vibration	No electrical discontinuity of 1 μ s or more	Frequency : 10 to 55Hz, single amplitude of 0.75mm 2 hours in each of the 3 directions.
Humidity (Steady State)	Contact resistance:30m Ω Max. Insulation resistance:1000M Ω Min.	96 hours at temperature of 40 \pm 2°C and humidity of 90% to 95%
Temperature Cycle	Contact resistance:30m Ω Max. Insulation resistance:1000M Ω Min.	(-55°C : 30 minutes \rightarrow 5 to 35°C : 10 minutes 85°C : 30 minutes \rightarrow 5 to 35°C : 10 minutes) 5 cycles
Mating Durability	Contact resistance:30m Ω Max.	Tin plating : 30 cycles Gold plating : 50 cycles
Resistance to Soldering Heat	No deformation of components affecting performance.	Flow : 260°C for 5 seconds Manual soldering : 300°C for 3 seconds

Materials / Finish

Product	Part	Material	Finish	Remarks	RoHS2
Socket	Insulator	Polyamide	White	UL94V-0	Yes
Crimping Contact for Socket	Contact	Phosphor Copper	Tin Plated or Gold Plated	-	
Pin Header	Insulator	Polyamide	White	UL94V-0	
	Contact	Brass	Tin Plated or Gold Plated	-	
In-line Plug	Insulator	Polyamide	White	UL94V-0	
Crimping Contact for In-line Plug	Contact	Phosphor Copper	Tin Plated or Gold Plated	-	

Product Number Structure

Refer to the chart below when determining the product specifications from the product number. Please select from the product numbers listed in this catalog when placing orders.

Connector

DF1B # - # S - 2.5 RC

① ② ③ ④ ⑤ ⑥

① Series Name	DF1B	④ Connector Type	S : Single Row Socket DS : Double Row Socket P : Single Row Pin Header DP : Double Row Pin Header ES : Single Row In-line Socket DES : Double Row In-line Socket EP : Single Row In-line Plug DEP : Double Row In-line Plug
② Style Symbol	Blank : Standard type A : In-line Plug (Simple Lock Type) Z : Pin Header (Standard Type, Tin Plated)	⑤ Contact Pitch	2.5mm
③ No. of Pos.	Single Row : 2 to 14 Double Row : 4 to 40	⑥ Contact Type	RC : IDC/Crimping Socket (Note) DSA : Straight Through Hole DS : Right Angle Through Hole

Crimping Contact

DF1B - 2428 SCF A

① ② ③

① Applicable Cable Size	2022 : 20 to 22 AWG 2428 : 24 to 28 AWG 30 : 30 AWG	③ Plating Type	Blank : Tin Plated A : Gold Plated B : Gold Plated (Note)
② Packaging Type	SCF : Socket Contact/Reel SC : Socket Contact/Bag PCF : Plug Contact/Reel PC : Plug Contact/Bag		

Note : Socket contacts have an "A" at the end of the product name. Plug contacts have a "B" at the end of the product name. The product numbers of gold plated plug contacts for 24 to 28 AWG cable are DF1-PD2428SCFB(Reel) and DF1-PD2428SCB(Bag).

Applicable Combination

● Single Row Type

Socket (Cable Side)
DF1B-#S-2.5R



Straight Through Hole Type
Pin Header
DF1B(Z)-#P-2.5DSA

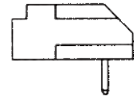

Right Angle Through Hole Type
Pin Header
DF1BZ-#P-2.5DS



Panel Mount Type
In-line Plug (Cable Side)
DF1BA-#EP-2.5RC

● Double Row Type

Socket (Cable Side)
DF1B-#DS-2.5RC



Straight Through Hole Type
Pin Header
DF1BZ-#DP-2.5DSA



Right Angle Through Hole Type
Pin Header
DF1BZ-#DP-2.5DS



Panel Mount Type
In-line Plug (Cable Side)
DF1BA-#DEP-2.5RC

《In-line/ Positive Lock Type》

● Single Row Type

Socket (Cable Side)
DF1B-#ES-2.5RC



In-line Plug (Cable Side)
DF1B-#EP-2.5RC

● Double Row Type

Socket (Cable Side)
DF1B-#DES-2.5RC

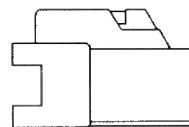

In-line Plug (Cable Side)
DF1B-#DEP-2.5RC

Single Row Socket



Shown with Contacts Inserted



Note : The 2pos. connector differs from the above figure and has a single center projection to prevent mis-insertion. For 3-6pos. there are two projections at both ends, and for 7-20pos. there are three projections.

Unit : mm

Part No.	HRS No.	No. of Pos.	A	B	Purchase Unit
DF1B-2S-2.5R	CL0541-0200-6-00	2	5.0	2.5	100pcs per bag
DF1B-3S-2.5R	CL0541-0201-9-00	3	7.5	5.0	
DF1B-4S-2.5R	CL0541-0202-1-00	4	10.0	7.5	
DF1B-5S-2.5R	CL0541-0203-4-00	5	12.5	10.0	
DF1B-6S-2.5R	CL0541-0204-7-00	6	15.0	12.5	
DF1B-7S-2.5R	CL0541-0205-0-00	7	17.5	15.0	
DF1B-8S-2.5R	CL0541-0206-2-00	8	20.0	17.5	
DF1B-9S-2.5R	CL0541-0207-5-00	9	22.5	20.0	
DF1B-10S-2.5R	CL0541-0208-8-00	10	25.0	22.5	
DF1B-12S-2.5R	CL0541-0210-0-00	12	30.0	27.5	
DF1B-14S-2.5R	CL0541-0212-5-00	14	35.0	32.5	

Double Row Socket



Shown with Contacts Inserted



Note : The 4pos. connector differs from the above figure and has a single center projection to prevent mis-insertion.

Unit : mm

Part No.	HRS No.	No. of Pos.	A	B	Purchase Unit
DF1B-4DS-2.5RC	CL0541-0648-0-00	4	7.5	2.5	100pcs per bag
DF1B-6DS-2.5RC	CL0541-0649-3-00	6	10.0	5.0	
DF1B-8DS-2.5RC	CL0541-0650-2-00	8	12.5	7.5	
DF1B-10DS-2.5RC	CL0541-0600-4-00	10	15.0	10.0	
DF1B-12DS-2.5RC	CL0541-0601-7-00	12	17.5	12.5	
DF1B-14DS-2.5RC	CL0541-0602-0-00	14	20.0	15.0	
DF1B-16DS-2.5RC	CL0541-0603-2-00	16	22.5	17.5	
DF1B-18DS-2.5RC	CL0541-0604-5-00	18	25.0	20.0	
DF1B-20DS-2.5RC	CL0541-0605-8-00	20	27.5	22.5	
DF1B-22DS-2.5RC	CL0541-0606-0-00	22	30.0	25.0	
DF1B-24DS-2.5RC	CL0541-0607-3-00	24	32.5	27.5	
DF1B-26DS-2.5RC	CL0541-0608-6-00	26	35.0	30.0	
DF1B-28DS-2.5RC	CL0541-0609-9-00	28	37.5	32.5	
DF1B-30DS-2.5RC	CL0541-0610-8-00	30	40.0	35.0	
DF1B-34DS-2.5RC	CL0541-0612-3-00	34	45.0	40.0	
DF1B-36DS-2.5RC	CL0541-0613-6-00	36	47.5	42.5	
DF1B-40DS-2.5RC	CL0541-0615-1-00	40	52.5	47.5	

Single Row Straight Pin Header



● Board Through-hole Diameter : $\phi 1.1^{+0.1}_0$



Note : The 2 and 3pos. connectors differ from the above figure and have a single center indentation to prevent mis-insertion. For 4-6pos. there are two indentations at both ends, and for 7-20pos. there are three indentations.

Recommended PCB Layout (t=1.6±0.1mm)

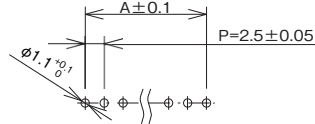

Unit : mm

Tin Plated		Gold Plated		No. of Pos.	A	B	Purchase Unit
Part No.	HRS No.	Part No.	HRS No.				
DF1BZ-2P-2.5DSA	CL0541-2000-8-00	DF1B-2P-2.5DSA(01)	CL0541-0225-7-01	2	2.5	7.5	100pcs per bag
DF1BZ-3P-2.5DSA	CL0541-2001-0-00	DF1B-3P-2.5DSA(01)	CL0541-0226-0-01	3	5.0	10.0	
DF1BZ-4P-2.5DSA	CL0541-2002-3-00	DF1B-4P-2.5DSA(01)	CL0541-0227-2-01	4	7.5	12.5	
DF1BZ-5P-2.5DSA	CL0541-2003-6-00	DF1B-5P-2.5DSA(01)	CL0541-0228-5-01	5	10.0	15.0	
DF1BZ-6P-2.5DSA	CL0541-2004-9-00	DF1B-6P-2.5DSA(01)	CL0541-0229-8-01	6	12.5	17.5	
DF1BZ-7P-2.5DSA	CL0541-2005-1-00	DF1B-7P-2.5DSA(01)	CL0541-0230-7-01	7	15.0	20.0	
DF1BZ-8P-2.5DSA	CL0541-2006-4-00	DF1B-8P-2.5DSA(01)	CL0541-0231-0-01	8	17.5	22.5	
DF1BZ-9P-2.5DSA	CL0541-2007-7-00	DF1B-9P-2.5DSA(01)	CL0541-0232-2-01	9	20.0	25.0	
DF1BZ-10P-2.5DSA	CL0541-2008-0-00	DF1B-10P-2.5DSA(01)	CL0541-0233-5-01	10	22.5	27.5	
DF1BZ-12P-2.5DSA	CL0541-2010-1-00	DF1B-12P-2.5DSA(01)	CL0541-0235-0-01	12	27.5	32.5	
DF1BZ-14P-2.5DSA	CL0541-2012-7-00	DF1B-14P-2.5DSA(01)	CL0541-0237-6-01	14	32.5	37.5	

Single Row Right Angle Pin Header



● Board Through-hole Diameter : $\phi 1.1^{+0.1}_0$



Note : The 2 and 3pos. connectors differ from the above figure and have a single center indentation to prevent mis-insertion. For 4-6pos. there are two indentations at both ends, and for 7-20pos. there are three indentations.

Recommended PCB Layout ($t=1.6\pm 0.1\text{mm}$)



Unit : mm

Tin Plated		Gold Plated		No. of Pos.	A	B	Purchase Unit
Part No.	HRS No.	Part No.	HRS No.				
DF1BZ-2P-2.5DS	CL0541-2034-0-00	DF1B-2P-2.5DS(01)	CL0541-0242-6-01	2	2.5	7.5	100pcs per bag
DF1BZ-3P-2.5DS	CL0541-2035-2-00	DF1B-3P-2.5DS(01)	CL0541-0243-9-01	3	5.0	10.0	
DF1BZ-4P-2.5DS	CL0541-2036-5-00	DF1B-4P-2.5DS(01)	CL0541-0244-1-01	4	7.5	12.5	
DF1BZ-5P-2.5DS	CL0541-2037-8-00	DF1B-5P-2.5DS(01)	CL0541-0245-4-01	5	10.0	15.0	
DF1BZ-6P-2.5DS	CL0541-2038-0-00	DF1B-6P-2.5DS(01)	CL0541-0246-7-01	6	12.5	17.5	
DF1BZ-7P-2.5DS	CL0541-2039-3-00	DF1B-7P-2.5DS(01)	CL0541-0247-0-01	7	15.0	20.0	
DF1BZ-8P-2.5DS	CL0541-2040-2-00	DF1B-8P-2.5DS(01)	CL0541-0248-2-01	8	17.5	22.5	
DF1BZ-9P-2.5DS	CL0541-2041-5-00	-	-	9	20.0	25.0	
DF1BZ-10P-2.5DS	CL0541-2042-8-00	DF1B-10P-2.5DS(01)	CL0541-0250-4-01	10	22.5	27.5	
DF1BZ-12P-2.5DS	CL0541-2044-3-00	DF1B-12P-2.5DS(01)	CL0541-0252-0-01	12	27.5	32.5	
DF1BZ-14P-2.5DS	CL0541-2046-9-00	DF1B-14P-2.5DS(01)	CL0541-0254-5-01	14	32.5	37.5	

Double Row Straight Pin Header



● Board Through-hole Diameter : $\phi 1.1^{+0.1}_0$



Note : The 4 and 6pos. connectors differ from the above figure and have a single center indentation to prevent mis-insertion.

Recommended PCB Layout (t=1.6±0.1mm)



Unit : mm

Tin Plated		Gold Plated		No. of Pos.	A	B	Purchase Unit
Part No.	HRS No.	Part No.	HRS No.				
DF1BZ-4DP-2.5DSA	CL0541-2017-0-00	DF1B-4DP-2.5DSA(01)	CL0541-0651-5-01	4	2.5	7.5	100pcs per bag
DF1BZ-6DP-2.5DSA	CL0541-2018-3-00	DF1B-6DP-2.5DSA(01)	CL0541-0652-8-01	6	5.0	10.0	
DF1BZ-8DP-2.5DSA	CL0541-2019-6-00	DF1B-8DP-2.5DSA(01)	CL0541-0653-0-01	8	7.5	12.5	
DF1BZ-10DP-2.5DSA	CL0541-2020-5-00	DF1B-10DP-2.5DSA(01)	CL0541-0616-4-01	10	10.0	15.0	
DF1BZ-12DP-2.5DSA	CL0541-2021-8-00	DF1B-12DP-2.5DSA(01)	CL0541-0617-7-01	12	12.5	17.5	
DF1BZ-14DP-2.5DSA	CL0541-2022-0-00	DF1B-14DP-2.5DSA(01)	CL0541-0618-0-01	14	15.0	20.0	
DF1BZ-16DP-2.5DSA	CL0541-2023-3-00	DF1B-16DP-2.5DSA(01)	CL0541-0619-2-01	16	17.5	22.5	
DF1BZ-18DP-2.5DSA	CL0541-2024-6-00	DF1B-18DP-2.5DSA(01)	CL0541-0620-1-01	18	20.0	25.0	
DF1BZ-20DP-2.5DSA	CL0541-2025-9-00	DF1B-20DP-2.5DSA(01)	CL0541-0621-4-01	20	22.5	27.5	
DF1BZ-22DP-2.5DSA	CL0541-2026-1-00	DF1B-22DP-2.5DSA(01)	CL0541-0622-7-01	22	25.0	30.0	
DF1BZ-24DP-2.5DSA	CL0541-2027-4-00	DF1B-24DP-2.5DSA(01)	CL0541-0623-0-01	24	27.5	32.5	
DF1BZ-26DP-2.5DSA	CL0541-2028-7-00	DF1B-26DP-2.5DSA(01)	CL0541-0624-2-01	26	30.0	35.0	
DF1BZ-28DP-2.5DSA	CL0541-2029-0-00	DF1B-28DP-2.5DSA(01)	CL0541-0625-5-01	28	32.5	37.5	
DF1BZ-30DP-2.5DSA	CL0541-2030-9-00	DF1B-30DP-2.5DSA(01)	CL0541-0626-8-01	30	35.0	40.0	
DF1BZ-34DP-2.5DSA	CL0541-2031-1-00	DF1B-34DP-2.5DSA(01)	CL0541-0628-3-01	34	40.0	45.0	
DF1BZ-36DP-2.5DSA	CL0541-2032-4-00	DF1B-36DP-2.5DSA(01)	CL0541-0629-6-01	36	42.5	47.5	
DF1BZ-40DP-2.5DSA	CL0541-2033-7-00	DF1B-40DP-2.5DSA(01)	CL0541-0631-8-01	40	47.5	52.5	

Double Row Right Angle Pin Header



● Board Through-hole Diameter : $\phi 1.1^{+0.1}_0$



Note : The 4 and 6pos. connectors differ from the above figure and have a single center indentation to prevent mis-insertion.

Recommended PCB Layout ($t=1.6\pm 0.1\text{mm}$)

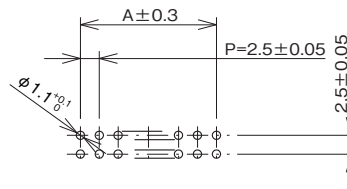

Unit : mm

Tin Plated		Gold Plated		No. of Pos.	A	B	Purchase Unit
Part No.	HRS No.	Part No.	HRS No.				
DF1BZ-4DP-2.5DS	CL0541-2051-9-00	DF1B-4DP-2.5DS(01)	CL0541-0654-3-01	4	2.5	7.5	100pcs per bag
DF1BZ-6DP-2.5DS	CL0541-2052-1-00	DF1B-6DP-2.5DS(01)	CL0541-0655-6-01	6	5.0	10.0	
DF1BZ-8DP-2.5DS	CL0541-2053-4-00	DF1B-8DP-2.5DS(01)	CL0541-0656-9-01	8	7.5	12.5	
DF1BZ-10DP-2.5DS	CL0541-2054-7-00	DF1B-10DP-2.5DS(01)	CL0541-0632-0-01	10	10.0	15.0	
DF1BZ-12DP-2.5DS	CL0541-2055-0-00	DF1B-12DP-2.5DS(01)	CL0541-0633-3-01	12	12.5	17.5	
DF1BZ-14DP-2.5DS	CL0541-2056-2-00	DF1B-14DP-2.5DS(01)	CL0541-0634-6-01	14	15.0	20.0	
DF1BZ-16DP-2.5DS	CL0541-2057-5-00	DF1B-16DP-2.5DS(01)	CL0541-0635-9-01	16	17.5	22.5	
DF1BZ-18DP-2.5DS	CL0541-2058-8-00	DF1B-18DP-2.5DS(01)	CL0541-0636-1-01	18	20.0	25.0	
DF1BZ-20DP-2.5DS	CL0541-2059-0-00	DF1B-20DP-2.5DS(01)	CL0541-0637-4-01	20	22.5	27.5	
DF1BZ-22DP-2.5DS	CL0541-2060-0-00	DF1B-22DP-2.5DS(01)	CL0541-0638-7-01	22	25.0	30.0	
DF1BZ-24DP-2.5DS	CL0541-2061-2-00	DF1B-24DP-2.5DS(01)	CL0541-0639-0-01	24	27.5	32.5	
DF1BZ-26DP-2.5DS	CL0541-2062-5-00	DF1B-26DP-2.5DS(01)	CL0541-0640-9-01	26	30.0	35.0	
DF1BZ-28DP-2.5DS	CL0541-2063-8-00	DF1B-28DP-2.5DS(01)	CL0541-0641-1-01	28	32.5	37.5	
DF1BZ-30DP-2.5DS	CL0541-2064-0-00	DF1B-30DP-2.5DS(01)	CL0541-0642-4-01	30	35.0	40.0	
DF1BZ-34DP-2.5DS	CL0541-2065-3-00	DF1B-34DP-2.5DS(01)	CL0541-0644-0-01	34	40.0	45.0	
DF1BZ-36DP-2.5DS	CL0541-2066-6-00	DF1B-36DP-2.5DS(01)	CL0541-0645-2-01	36	42.5	47.5	
DF1BZ-40DP-2.5DS	CL0541-2067-9-00	DF1B-40DP-2.5DS(01)	CL0541-0647-8-01	40	47.5	52.5	

Single Row In-line Plug (Friction Lock Type)



Shown with Contacts Inserted
 ●Applicable Socket: DF1B-#S-2.5R



Note : The 2pos. connector differs from the above figure and has a single center indentation to prevent mis-insertion. For 3-6pos. there are two indentations at both ends, and for 7-20pos. there are three indentations.

Unit : mm

Part No.	HRS No.	No. of Pos.	A	B	Purchase Unit
DF1BA-2EP-2.5RC	CL0541-0700-9-00	2	2.5	7.1	100pcs per bag
DF1BA-3EP-2.5RC	CL0541-0701-1-00	3	5.0	9.6	
DF1BA-4EP-2.5RC	CL0541-0702-4-00	4	7.5	12.1	
DF1BA-5EP-2.5RC	CL0541-0703-7-00	5	10.0	14.6	
DF1BA-6EP-2.5RC	CL0541-0704-0-00	6	12.5	17.1	
DF1BA-7EP-2.5RC	CL0541-0705-2-00	7	15.0	19.6	
DF1BA-8EP-2.5RC	CL0541-0706-5-00	8	17.5	22.1	
DF1BA-9EP-2.5RC	CL0541-0707-8-00	9	20.0	24.6	
DF1BA-10EP-2.5RC	CL0541-0708-0-00	10	22.5	27.1	

Panel Cutouts



Note : Do not use a rounded surface at the panel tab portion.

Unit : mm

Applicable Plug	No. of Pos.	C			D
		Panel Board Thickness (Note 1)			
		0.5 to 1.2	1.3 to 1.6	1.7 to 2.0	
DF1BA-2EP-2.5RC	2	11.2	11.9	12.6	7.3
DF1BA-3EP-2.5RC	3	13.7	14.4	15.1	9.8
DF1BA-4EP-2.5RC	4	16.2	16.9	17.6	12.3
DF1BA-5EP-2.5RC	5	18.7	19.4	20.1	14.8
DF1BA-6EP-2.5RC	6	21.2	21.9	22.6	17.3
DF1BA-7EP-2.5RC	7	23.7	24.4	25.1	19.8
DF1BA-8EP-2.5RC	8	26.2	26.9	27.6	22.3
DF1BA-9EP-2.5RC	9	28.7	29.4	30.1	24.8
DF1BA-10EP-2.5RC	10	31.2	31.9	32.6	27.3

Note 1 : The installation hole size C varies based on the panel board thickness.

Note 2 : Fabricate installation holes so that no burrs occur.

Double Row In-line Plug (Friction Lock Type)



Shown with Contacts Inserted
 ●Applicable Socket : DF1B-#DS-2.5RC



Note : The 4pos. connector differs from the above figure and has a single center indentation to prevent mis-insertion.

Unit : mm

Part No.	HRS No.	No. of Pos.	A	B	Purchase Unit
DF1BA-4DEP-2.5RC	CL0541-0719-7-00	4	2.5	8.6	100pcs per bag
DF1BA-6DEP-2.5RC	CL0541-0720-6-00	6	5.0	11.1	
DF1BA-8DEP-2.5RC	CL0541-0721-9-00	8	7.5	13.6	
DF1BA-10DEP-2.5RC	CL0541-0722-1-00	10	10.0	16.1	
DF1BA-12DEP-2.5RC	CL0541-0723-4-00	12	12.5	18.6	
DF1BA-14DEP-2.5RC	CL0541-0724-7-00	14	15.0	21.1	
DF1BA-16DEP-2.5RC	CL0541-0725-0-00	16	17.5	23.6	
DF1BA-18DEP-2.5RC	CL0541-0726-2-00	18	20.0	26.1	
DF1BA-20DEP-2.5RC	CL0541-0727-5-00	20	22.5	28.6	
DF1BA-22DEP-2.5RC	CL0541-0728-8-00	22	25.0	31.1	
DF1BA-24DEP-2.5RC	CL0541-0729-0-00	24	27.5	33.6	
DF1BA-26DEP-2.5RC	CL0541-0730-0-00	26	30.0	36.1	
DF1BA-28DEP-2.5RC	CL0541-0731-2-00	28	32.5	38.6	
DF1BA-30DEP-2.5RC	CL0541-0732-5-00	30	35.0	41.1	
DF1BA-34DEP-2.5RC	CL0541-0734-0-00	34	40.0	46.1	

Panel Cutouts



Note : Do not use a rounded surface at the panel tab portion.

Unit : mm

Applicable Plug	No. of Pos.	C			D
		Panel Board Thickness (Note 1)			
		0.5 to 1.2	1.3 to 1.6	1.7 to 2.0	
DF1BA-4DEP-2.5RC	4	12.7	13.4	14.1	8.8
DF1BA-6DEP-2.5RC	6	15.2	15.9	16.6	11.3
DF1BA-8DEP-2.5RC	8	17.7	18.4	19.1	13.8
DF1BA-10DEP-2.5RC	10	20.2	20.9	21.6	16.3
DF1BA-12DEP-2.5RC	12	22.7	23.4	24.1	18.8
DF1BA-14DEP-2.5RC	14	25.2	25.9	26.6	21.3
DF1BA-16DEP-2.5RC	16	27.7	28.4	29.1	23.8
DF1BA-18DEP-2.5RC	18	30.2	30.9	31.6	26.3
DF1BA-20DEP-2.5RC	20	32.7	33.4	34.1	28.8
DF1BA-22DEP-2.5RC	22	35.2	35.9	36.6	31.3
DF1BA-24DEP-2.5RC	24	37.7	38.4	39.1	33.8
DF1BA-26DEP-2.5RC	26	40.2	40.9	41.6	36.3
DF1BA-28DEP-2.5RC	28	42.7	43.4	44.1	38.8
DF1BA-30DEP-2.5RC	30	45.2	45.9	46.6	41.3
DF1BA-34DEP-2.5RC	34	50.2	50.9	51.6	46.3

Note 1 : The installation hole size C varies based on the panel board thickness.

Note 2 : Fabricate installation holes so that no burrs occur.

Single Row In-line Socket (Positive Lock Type)



Shown with Contacts Inserted

●Applicable Socket : DF1B-#EP-2.5RC



Unit : mm

Part No.	HRS No.	No. of Pos.	A	B	Purchase Unit
DF1B-2ES-2.5RC	CL0541-0320-8-00	2	2.5	6.5	100pcs per bag
DF1B-3ES-2.5RC	CL0541-0321-0-00	3	5.0	9.0	
DF1B-4ES-2.5RC	CL0541-0322-3-00	4	7.5	11.5	
DF1B-5ES-2.5RC	CL0541-0323-6-00	5	10.0	14.0	
DF1B-6ES-2.5RC	CL0541-0324-9-00	6	12.5	16.5	
DF1B-7ES-2.5RC	CL0541-0325-1-00	7	15.0	19.0	
DF1B-8ES-2.5RC	CL0541-0326-4-00	8	17.5	21.5	
DF1B-9ES-2.5RC	CL0541-0327-7-00	9	20.0	24.0	
DF1B-10ES-2.5RC	CL0541-0328-0-00	10	22.5	26.5	

Panel Cutouts



Note : Do not use a rounded surface at the panel tab portion.

Unit : mm

Applicable Plug	No. of Pos.	C	D	E		
				Panel Board Thickness (Note 1)		
				0.5 to 1.2	1.3 to 1.6	1.7 to 2.0
DF1B-2ES-2.5RC	2	4.7	6.7	10.8	11.3	12.0
DF1B-3ES-2.5RC	3	7.2	9.2	13.3	13.8	14.5
DF1B-4ES-2.5RC	4	9.7	11.7	15.8	16.3	17.0
DF1B-5ES-2.5RC	5	12.2	14.2	18.3	18.8	19.5
DF1B-6ES-2.5RC	6	14.7	16.7	20.8	21.3	22.0
DF1B-7ES-2.5RC	7	17.2	19.2	23.3	23.8	24.5
DF1B-8ES-2.5RC	8	19.7	21.7	25.8	26.3	27.0
DF1B-9ES-2.5RC	9	22.2	24.2	28.3	28.8	29.5
DF1B-10ES-2.5RC	10	24.7	26.7	30.8	31.3	32.0

Note 1 : The installation hole size E varies based on panel board thickness.

Note 2 : Fabricate installation holes so that no burrs occur.

Double Row In-line Socket (Positive Lock Type)



Shown with Contacts Inserted
 ●Applicable Socket : DF1B-#DEP-2.5RC



Unit : mm

Part No.	HRS No.	No. of Pos.	A	B	Purchase Unit
DF1B-10DES-2.5RC	CL0541-0351-1-00	10	10.0	15.0	100pcs per bag
DF1B-12DES-2.5RC	CL0541-0352-4-00	12	12.5	17.5	
DF1B-14DES-2.5RC	CL0541-0353-7-00	14	15.0	20.0	
DF1B-16DES-2.5RC	CL0541-0354-0-00	16	17.5	22.5	
DF1B-18DES-2.5RC	CL0541-0346-1-00	18	20.0	25.0	
DF1B-20DES-2.5RC	CL0541-0355-2-00	20	22.5	27.5	
DF1B-22DES-2.5RC	CL0541-0356-5-00	22	25.0	30.0	
DF1B-24DES-2.5RC	CL0541-0357-8-00	24	27.5	32.5	
DF1B-26DES-2.5RC	CL0541-0358-0-00	26	30.0	35.0	
DF1B-28DES-2.5RC	CL0541-0359-3-00	28	32.5	37.5	
DF1B-30DES-2.5RC	CL0541-0360-2-00	30	35.0	40.0	
DF1B-32DES-2.5RC	CL0541-0361-5-00	32	37.5	42.5	
DF1B-34DES-2.5RC	CL0541-0362-8-00	34	40.0	45.0	

Panel Cutouts



Note : Do not use a rounded surface at the panel tab portion.

Unit : mm

Applicable Plug	No. of Pos.	C			D	E
		Panel Board Thickness (Note 1)				
		0.5 to 1.2	1.3 to 1.6	1.7 to 2.0		
DF1B-10DES-2.5RC	10	19.1	19.8	20.5	15.2	3.7
DF1B-12DES-2.5RC	12	21.6	22.3	23.0	17.7	3.7
DF1B-14DES-2.5RC	14	24.1	24.8	25.5	20.2	3.7
DF1B-16DES-2.5RC	16	26.6	27.3	28.0	22.7	3.7
DF1B-18DES-2.5RC	18	29.1	29.8	30.5	25.2	3.7
DF1B-20DES-2.5RC	20	31.6	32.3	33.0	27.7	5.2
DF1B-22DES-2.5RC	22	34.1	34.8	35.5	30.2	5.2
DF1B-24DES-2.5RC	24	36.6	37.3	38.0	32.7	5.2
DF1B-26DES-2.5RC	26	39.1	39.8	40.5	35.2	5.2
DF1B-28DES-2.5RC	28	41.6	42.3	43.0	37.7	5.2
DF1B-30DES-2.5RC	30	44.1	44.8	45.5	40.2	5.2
DF1B-32DES-2.5RC	32	46.6	47.3	48.0	42.7	5.2
DF1B-34DES-2.5RC	34	49.1	49.8	50.5	45.2	5.2

Note 1 : The installation hole size C varies based on panel board thickness.

Note 2 : Fabricate installation holes so that no burrs occur.

Single Row In-line Plug (Positive Lock Type)



Shown with Contacts Inserted
 ●Applicable Socket : DF1B-#ES-2.5RC



Unit : mm

Part No.	HRS No.	No. of Pos.	A	B	Purchase Unit
DF1B-2EP-2.5RC	CL0541-0332-7-00	2	8.9	2.5	100pcs per bag
DF1B-3EP-2.5RC	CL0541-0333-0-00	3	11.4	5.0	
DF1B-4EP-2.5RC	CL0541-0334-2-00	4	13.9	7.5	
DF1B-5EP-2.5RC	CL0541-0335-5-00	5	16.4	10.0	
DF1B-6EP-2.5RC	CL0541-0336-8-00	6	18.9	12.5	
DF1B-7EP-2.5RC	CL0541-0337-0-00	7	21.4	15.0	
DF1B-8EP-2.5RC	CL0541-0338-3-00	8	23.9	17.5	
DF1B-9EP-2.5RC	CL0541-0339-6-00	9	26.4	20.0	
DF1B-10EP-2.5RC	CL0541-0340-5-00	10	28.9	22.5	

Double Row In-line Plug (Positive Lock Type)



Shown with Contacts Inserted

●Applicable Socket : DF1B-#DES-2.5RC

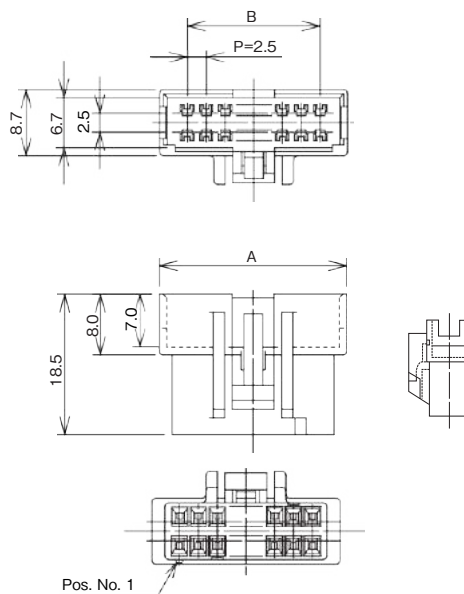

Unit : mm

Part No.	HRS No.	No. of Pos.	A	B	Purchase Unit
DF1B-10DEP-2.5RC	CL0541-0366-9-00	10	17.2	10.0	100pcs per bag
DF1B-12DEP-2.5RC	CL0541-0367-1-00	12	19.7	12.5	
DF1B-14DEP-2.5RC	CL0541-0368-4-00	14	22.2	15.0	
DF1B-16DEP-2.5RC	CL0541-0369-7-00	16	24.7	17.5	
DF1B-18DEP-2.5RC	CL0541-0350-9-00	18	27.2	20.0	
DF1B-20DEP-2.5RC	CL0541-0370-6-00	20	29.7	22.5	
DF1B-22DEP-2.5RC	CL0541-0371-9-00	22	32.2	25.0	
DF1B-24DEP-2.5RC	CL0541-0372-1-00	24	34.7	27.5	
DF1B-26DEP-2.5RC	CL0541-0373-4-00	26	37.2	30.0	
DF1B-28DEP-2.5RC	CL0541-0374-7-00	28	39.7	32.5	
DF1B-30DEP-2.5RC	CL0541-0375-0-00	30	42.2	35.0	
DF1B-32DEP-2.5RC	CL0541-0376-2-00	32	44.7	37.5	
DF1B-34DEP-2.5RC	CL0541-0377-5-00	34	47.2	40.0	

Crimping Contact for Socket

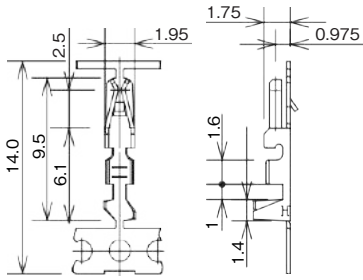

●Strip Length : 2.0 to 2.5mm

●Reel Contact Applicable Tool : Applicator

Part No.	HRS No.	Finish	Purchase Unit	Applicable Cable (Tin Plated Annealing Copper Wire)				
				UL Style	AWG	Wire Construction	Sectional Area	Jacket Diameter
DF1B-2022SCF	CL0541-0223-1-00	Tin Plated	10,000pcs per reel	1061, 1007	20	21/0.18mm	0.540mm ²	1.2 to 1.9mm
					22	17/0.16mm	0.342mm ²	
DF1B-2022SCFA	CL0541-0662-1-00	Gold Plated		1061, 1007	20	21/0.18mm	0.540mm ²	1.2 to 1.9mm
					22	17/0.16mm	0.342mm ²	
DF1B-2428SCF	CL0541-0678-1-00	Tin Plated		1061, 1007	24	11/0.16mm	0.221mm ²	0.9 to 1.5mm
					26	7/0.16mm	0.141mm ²	
					28	7/0.127mm	0.089mm ²	
DF1B-2428SCFA	CL0541-0680-3-00	Gold Plated		1061, 1007	24	11/0.16mm	0.221mm ²	0.9 to 1.5mm
					26	7/0.16mm	0.141mm ²	
					28	7/0.127mm	0.089mm ²	
DF1B-30SCF	CL0541-0682-9-00	Tin Plated		1061, 1007	30	7/0.1mm	0.055mm ²	0.6 to 1.2mm
DF1B-30SCFA	CL0541-0684-4-00	Gold Plated		1061, 1007	30	7/0.1mm	0.055mm ²	0.6 to 1.2mm

Note : When using cables other than those specified, contact a Hirose sales representative.

●Loose Contact Applicable Tool : Manual Crimping Tool

Part No.	HRS No.	Finish	Purchase Unit	Applicable Cable (Tin Plated Annealing Copper Wire)				
				UL Style	AWG	Wire Construction	Sectional Area	Jacket Diameter
DF1B-2022SC	CL0541-0224-4-00	Tin Plated	100pcs per bag	1007	20	21/0.18mm	0.540mm ²	1.8mm
					22	17/0.16mm	0.342mm ²	1.6mm
DF1B-2022SCA	CL0541-0663-4-00	Gold Plated		1007	20	21/0.18mm	0.540mm ²	1.8mm
					22	17/0.16mm	0.342mm ²	1.6mm
DF1B-2428SC	CL0541-0679-4-00	Tin Plated		1007	24	11/0.16mm	0.221mm ²	1.5mm
					26	7/0.16mm	0.141mm ²	1.3mm
					28	7/0.127mm	0.089mm ²	1.2mm
DF1B-2428SCA	CL0541-0681-6-00	Gold Plated		1007	24	11/0.16mm	0.221mm ²	1.5mm
					26	7/0.16mm	0.141mm ²	1.3mm
					28	7/0.127mm	0.089mm ²	1.2mm
DF1B-30SC	CL0541-0683-1-00	Tin Plated		1007	30	7/0.1mm	0.055mm ²	1.1mm
DF1B-30SCA	CL0541-0685-7-00	Gold Plated		1007	30	7/0.1mm	0.055mm ²	1.1mm

Note : Only the above cables are suitable when using the manual IDC tool.

●Crimping Contact Extraction Tool : DF-C-PO(B)

Crimping Contact for Plug

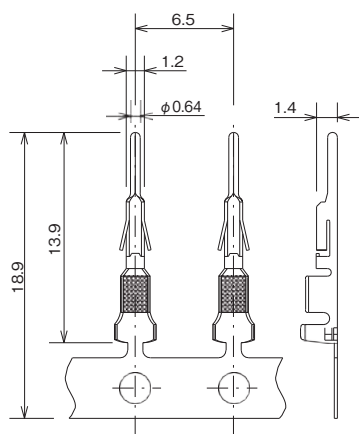

●Strip Length : 3.0 to 3.7mm

●Reel Contact Applicable Tool : Applicator

Part No.	HRS No.	Finish	Purchase Unit	Applicable Cable (Tin Plated Annealing Copper Wire)				
				UL Style	AWG	Wire Construction	Sectional Area	Jacket Diameter
DF1B-2022PCF	CL0541-0259-9-00	Tin Plated	10,000pcs per reel	1061, 1007	20	21/0.18mm	0.540mm ²	1.2 to 1.9mm
					22	17/0.16mm	0.342mm ²	
DF1B-2022PCFB	CL0541-0690-7-00	Gold Plated		1061, 1007	20	21/0.18mm	0.540mm ²	1.2 to 1.9mm
					22	17/0.16mm	0.342mm ²	
DF1B-2428PCF	CL0541-0664-7-00	Tin Plated		1061, 1007	24	11/0.16mm	0.221mm ²	0.9 to 1.5mm
					26	7/0.16mm	0.141mm ²	
					28	7/0.127mm	0.089mm ²	
DF1-PD2428SCFB	CL0541-0660-6-00	Gold Plated		1061, 1007	24	11/0.16mm	0.221mm ²	0.9 to 1.5mm
					26	7/0.16mm	0.141mm ²	
					28	7/0.127mm	0.089mm ²	
DF1B-30PCF	CL0541-0686-0-00	Tin Plated		1061, 1007	30	7/0.1mm	0.055mm ²	0.6 to 1.2mm
DF1B-30PCFB	CL0541-0688-5-00	Gold Plated		1061, 1007	30	7/0.1mm	0.055mm ²	0.6 to 1.2mm

Note : When using cables other than those specified, contact a Hirose sales representative.

●Loose Contact Applicable Tool : Manual Crimping Tool

Part No.	HRS No.	Finish	Purchase Unit	Applicable Cable (Tin Plated Annealing Copper Wire)				
				UL Style	AWG	Wire Construction	Sectional Area	Jacket Diameter
DF1B-2022PC	CL0541-0260-8-00	Tin Plated	100pcs per bag	1007	20	21/0.18mm	0.540mm ²	1.8mm
					22	17/0.16mm	0.342mm ²	1.6mm
DF1B-2022PCB	CL0541-0691-0-00	Gold Plated		1007	20	21/0.18mm	0.540mm ²	1.8mm
					22	17/0.16mm	0.342mm ²	1.6mm
DF1B-2428PC	CL0541-0665-0-00	Tin Plated		1007	24	11/0.16mm	0.221mm ²	1.5mm
					26	7/0.16mm	0.141mm ²	1.3mm
					28	7/0.127mm	0.089mm ²	1.2mm
DF1-PD2428SCB	CL0541-0661-9-00	Gold Plated		1007	24	11/0.16mm	0.221mm ²	1.5mm
					26	7/0.16mm	0.141mm ²	1.3mm
					28	7/0.127mm	0.089mm ²	1.2mm
DF1B-30PC	CL0541-0687-2-00	Tin Plated	1007	30	7/0.1mm	0.055mm ²	1.1mm	
DF1B-30PCB	CL0541-0689-8-00	Gold Plated	1007	30	7/0.1mm	0.055mm ²	1.1mm	

Note : Only the above cables are suitable when using the manual IDC tool.

●Crimping Contact Extraction Tool : DF-C-PO(C)

Applicable Tool

Connection Type	Type	Part No.	HRS No.	Applicable Contacts
Crimping	Applicator	AP105-DF1B-2022S	CL0901-4510-9-00	DF1B-2022SCF(A)
		AP105-DF1B-2428S	CL0901-4518-0-00	DF1B-2428SCF(A)
		AP105-DF1B-30S	CL0901-4517-8-00	DF1B-30SCF(A)
		AP105-DF1B-2022P	CL0901-4509-0-00	DF1B-2022PCF(B)
		AP105-DF1B-2428P	CL0901-4521-5-00	DF1B-2428PCF, DF1-PD2428SCFB
		AP105-DF1B-30P	CL0901-4519-3-00	DF1B-30PCF(B)
	Manual Crimping Tool	DF1B-TA2022SHC	CL0550-0182-7-00	DF1B-2022SC(A)
		DF1B-TA2428SHC	CL0550-0209-1-00	DF1B-2428SC(A)
		DF1B-TA30SHC	CL0550-0211-3-00	DF1B-30SC(A)
		DF1B-TA2022PHC	CL0550-0183-0-00	DF1B-2022PC(B)
		HT802/DF1B-2428P(A)	CL0550-0430-0-00	DF1B-2428PC, DF1-PD2428SCB
		DF1B-TA30PHC	CL0550-0210-0-00	DF1B-30PC(B)
Press Main Unit	CM-105C	CL0901-0001-0-00	-	
Extraction Tool	DF-C-PO(B)	CL0550-0179-2-00	DF1B-####SCF	
	DF-C-PO(C)	CL0550-0198-7-00	DF1B-####PCF	

Note 1 : Please conduct crimping work according to the table in the Crimp Quality Standard (ETAD-H0909-00, ETAD-H0913-00).

Note 2 : Problems with tools other than those specified by Hirose are outside the scope of warranty.

Note 3 : #### indicates the applicable wire sizes.

Note 4 : When non-authorized tools are used, please consult with Hirose sales representative about provision of the drawing of the crimping tool.

Crimping

Items required prior to start crimping

The work-related documents shown below are required before starting harness assembly.

(The ● mark represents required documents.)

Please contact your Hirose sales representative if you do not have these documents.

Document Title	Description	Automatic Crimping Machine	Hand Crimping Tool	Remarks
Crimping Machine Main Unit Instruction Manual	Explanation of main press machine unit	●	—	Bundled with purchase of main press machine unit.
Applicator Spare Parts Identification	Explanation for Applicator installation	●	—	Bundled with purchase of applicator.
Crimp Conditions	Standard Crimp Height and Tensile Strength Values	●	—	
Crimp Quality Standards	Various standards for crimping conditions	●	—	
Operating Instructions for Hand Tool	Crimp height, Standard values of tensile strength and others	—	●	Bundled with purchase of hand tool.
Harness Procedure Manual	Harness Procedure	●	●	Ask a Hirose sales personnel to provide them.

Tools

When crimping work is applied to our contacts, use the tools designated by Hirose.

※Crimping performed with tools other than those designated should be avoided as it may result in contact failure, disconnection of cable, etc.

※The operating instructions manual is available for the crimping machine and the applicator. Be sure to carefully read the operating instructions manual before beginning work.

Applicable Cables

Check that the cables to be used are within the applicable range.

If you intend to use a cable other than those recommended, contact a sales representative.

[Precautions]

- Cables applicable to crimping connectors are tin-plated stranded soft-copper wire.
- Avoid crimping solid wire, wires with polyester threads or tin coated wires.
- Avoid crimping two cables together.
- The crimp height setting values (Note) may vary between tin-plated and gold-plated terminals even if the same electric wires are used.
- The crimp height setting values (Note) may vary depending on the difference in the core wire configuration even if the computed cross-sectional area is the same.

Note : The crimp height is an important item that determines crimping quality. We execute crimping tests for each electric wire to ensure the optimal value for the crimp height with high precision, thereby ensuring optimal setup values.

Application Pattern



Precautions

1. Cleaning Condition	Refer to the "Wire-to-Board Connector Use Handbook".
2. Connection Condition	Refer to the "Wire-to-Board Connector Use Handbook".
3. Cautions	The color of the plastic molding may differ slightly depending on product lot and future storage conditions but this does not affect the product performance. Black spots may appear on the mold resin but this does not affect the product quality.
4. Precaution	Please refer to the following documents. <ul style="list-style-type: none"> ■ Crimp Quality Standards (ETAD-H0909-00, ETAD-H0913-00) ■ Harness Procedure Manual (ATAD-H0677-00) ■ Extraction Tool Procedure Manual ■ User Guide for Wire-to-Board Connectors

While Taking into Consideration

Specifications mentioned in this catalog are reference values.

When considering to order or use this product, please review the Drawing and Product Specifications sheets.

Use an appropriate cable when using the connector in combination with cables.

If considering usage of a non-specified cable, please contact your sales representative.

If assembly process is done by jigs & tools which are not identified by Hirose, the warranty of the product may be affected.

If considering usage for below mentioned applications, please contact your sales representative.

In cases where the application will demand a high level of reliability, such as automotive, medical instruments, public infrastructure, aerospace/ defense etc. Hirose must review before assurance of reliability can be given.

HIROSE

HRS HIROSE ELECTRIC CO.,LTD.

2-6-3 Nakagawa Chuoh, Tsuzuki-Ku, Yokohama-Shi 224-8540, JAPAN
<https://www.hirose.com>

Looking for pricing, stock, or lifecycle information?

Click below to explore more details on WIN SOURCE:

- [View DF1B-12DP-2.5DSA\(01\) on WIN SOURCE](#)
- [Hirose Electric Co Ltd Information](#)

Optimize Your Supply Chain with WIN SOURCE Solutions

- ✓ Global Sourcing Solution
- ✓ Obsolete Management
- ✓ Cost Control Management
- ✓ Shortage Management
- ✓ Alternative Solution
- ✓ Excess Inventory Management