



**THE DATASHEET OF  
MMSZ5258BS\_R1\_00001**



## MMSZ5221BS ~ MMSZ5267BS Series

### SURFACE MOUNT SILICON ZENER DIODES

**VOLTAGE** 2.4 to 75 Volt    **POWER** 200 mWatt

**SOD-323**

Unit : inch(mm)

#### FEATURES

- Planar Die construction
- 200mW Power Dissipation
- Ideally Suited for Automated Assembly Processes
- Lead free in compliance with EU RoHS 2.0
- Green molding compound as per IEC 61249 standard

#### MECHANICAL DATA

- Case : SOD-323, Molded Plastic
- Terminals : Solderable per MIL-STD-750, Method 2026
- Polarity : Color band denotes cathode end
- Appox Weight : 0.0041 grams

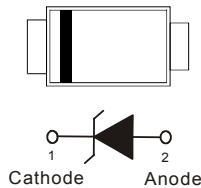
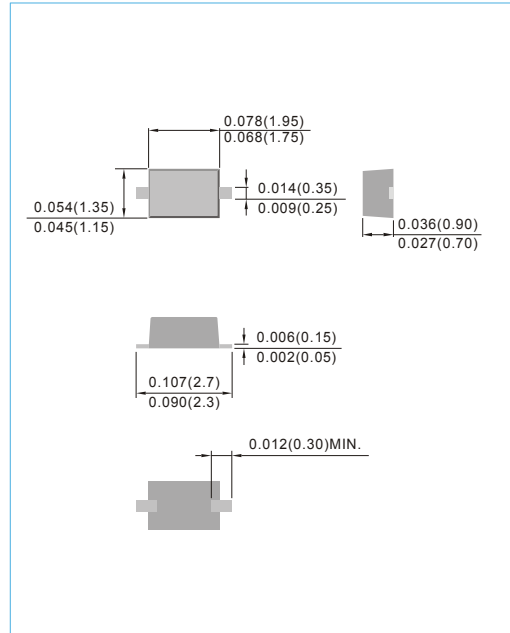

### MAXIMUM RATINGS AND ELECTRICAL CHARACTERISTICS

Parameter	Symbol	Value	Units
Power Dissipation @ $T_A=25^{\circ}\text{C}$ (Note A)	$P_D$	200	mW
Operating Junction and Storage Temperature Range	$T_J$	-55 to +150	$^{\circ}\text{C}$

#### NOTES :

A. Mounted on 5mm<sup>2</sup>(0.013mm thick) land areas.

## MMSZ5221BS ~ MMSZ5267BS Series

Part Number	Nominal Zener Voltage			Max. Zener Impedance				Max Reverse Leakage Current		Marking Code
	V <sub>Z</sub> @ I <sub>ZT</sub>			Z <sub>ZT</sub> @ I <sub>ZT</sub>		Z <sub>ZK</sub> @ I <sub>ZK</sub>		I <sub>R</sub> @ V <sub>R</sub>		
	Nom. V	Min. V	Max. V	Ω	mA	Ω	mA	μA	V	
<b>200 mWatts Zener Diodes</b>										
MMSZ5221BS	2.4	2.28	2.52	30	20.0	1200	0.25	100	1.0	C1
MMSZ5222BS	2.5	2.38	2.63	30	20.0	1250	0.25	100	1.0	C2
MMSZ5223BS	2.7	2.57	2.84	30	20.0	1300	0.25	75	1.0	C3
MMSZ5225BS	3	2.85	3.15	30	20.0	1600	0.25	50	1.0	C5
MMSZ5226BS	3.3	3.14	3.47	28	20.0	1600	0.25	25	1.0	D1
MMSZ5227BS	3.6	3.42	3.78	24	20.0	1700	0.25	15	1.0	D2
MMSZ5228BS	3.9	3.71	4.10	23	20.0	1900	0.25	10	1.0	D3
MMSZ5229BS	4.3	4.09	4.52	22	20.0	2000	0.25	5.0	1.0	D4
MMSZ5230BS	4.7	4.47	4.94	19	20.0	1900	0.25	5.0	2.0	D5
MMSZ5231BS	5.1	4.85	5.36	17	20.0	1600	0.25	5.0	2.0	E1
MMSZ5232BS	5.6	5.32	5.88	11	20.0	1600	0.25	5.0	3.0	E2
MMSZ5234BS	6.2	5.89	6.51	7	20.0	1000	0.25	5.0	4.0	E4
MMSZ5235BS	6.8	6.46	7.14	5	20.0	750	0.25	3.0	5.0	E5
MMSZ5236BS	7.5	7.13	7.88	6	20.0	500	0.25	3.0	6.0	F1
MMSZ5237BS	8.2	7.79	8.61	8	20.0	500	0.25	3.0	6.0	F2
MMSZ5238BS	8.7	8.27	9.14	8	20.0	600	0.25	3.0	6.5	F3
MMSZ5239BS	9.1	8.65	9.56	10	20.0	600	0.25	3.0	6.5	F4
MMSZ5240BS	10	9.50	10.50	17	20.0	600	0.25	3.0	8.0	F5
MMSZ5241BS	11	10.45	11.55	22	20.0	600	0.25	2.0	8.4	H1
MMSZ5242BS	12	11.40	12.60	30	20.0	600	0.25	1.0	9.1	H2
MMSZ5243BS	13	12.35	13.65	13	9.5	600	0.25	0.5	9.9	H3
MMSZ5244BS	14	13.30	14.70	15	9.0	600	0.25	0.1	10.5	H4
MMSZ5245BS	15	14.25	15.75	16	8.5	600	0.25	0.1	11.0	H5
MMSZ5246BS	16	15.20	16.80	17	7.8	600	0.25	0.1	12.0	J1
MMSZ5247BS	17	16.15	17.85	19	7.5	600	0.25	0.1	13.0	J2
MMSZ5248BS	18	17.10	18.90	21	7.0	600	0.25	0.1	14.0	J3
MMSZ5250BS	20	19.00	21.00	25	6.2	600	0.25	0.1	15.0	J5
MMSZ5251BS	22	20.90	23.10	29	5.6	600	0.25	0.1	17.0	K1
MMSZ5252BS	24	22.80	25.20	33	5.2	600	0.25	0.1	18.0	K2
MMSZ5254BS	27	25.65	28.35	41	5.0	600	0.25	0.1	21.0	K4
MMSZ5255BS	28	26.60	29.40	44	4.5	600	0.25	0.1	21.0	K5
MMSZ5256BS	30	28.50	31.50	49	4.2	600	0.25	0.1	23.0	M1
MMSZ5257BS	33	31.35	34.65	58	3.8	700	0.25	0.1	25.0	M2
MMSZ5258BS	36	34.20	37.80	70	3.4	700	0.25	0.1	27.0	M3
MMSZ5259BS	39	37.05	40.95	80	3.2	800	0.25	0.1	30.0	M4
MMSZ5260BS	43	40.85	45.15	93	3.0	900	0.25	0.1	33.0	M5
MMSZ5261BS	47	44.65	49.35	105	2.7	1000	0.25	0.1	36.0	N1
MMSZ5262BS	51	48.45	53.55	125	2.5	1100	0.25	0.1	39.0	N2

## MMSZ5221BS ~ MMSZ5267BS Series

Part Number	Nominal Zener Voltage			Max. Zener Impedance				Max Reverse Leakage Current		Marking Code
	V <sub>Z</sub> @ I <sub>ZT</sub>			Z <sub>ZT</sub> @ I <sub>ZT</sub>		Z <sub>ZK</sub> @ I <sub>ZK</sub>		I <sub>R</sub> @ V <sub>R</sub>		
	Nom. V	Min. V	Max. V	Ω	mA	Ω	mA	μA	V	
MMSZ5263BS	56	53.2	58.8	150	2.2	1300	0.25	0.1	43	N3
MMSZ5264BS	60	57	63	170	2.1	1400	0.25	0.1	46	N4
MMSZ5265BS	62	58.9	65.1	185	2	1500	0.25	0.1	47	N5
MMSZ5266BS	68	64.6	71.4	230	1.8	1600	0.25	0.1	52	P1
MMSZ5267BS	75	71.25	78.75	270	1.7	1400	0.25	0.1	56	P2

## MMSZ5221BS ~ MMSZ5267BS Series

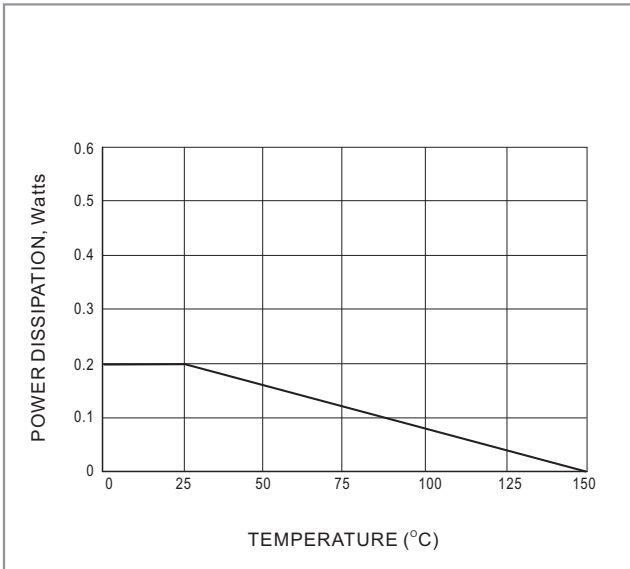

Fig.1 STEADY STATE POWER DERATING

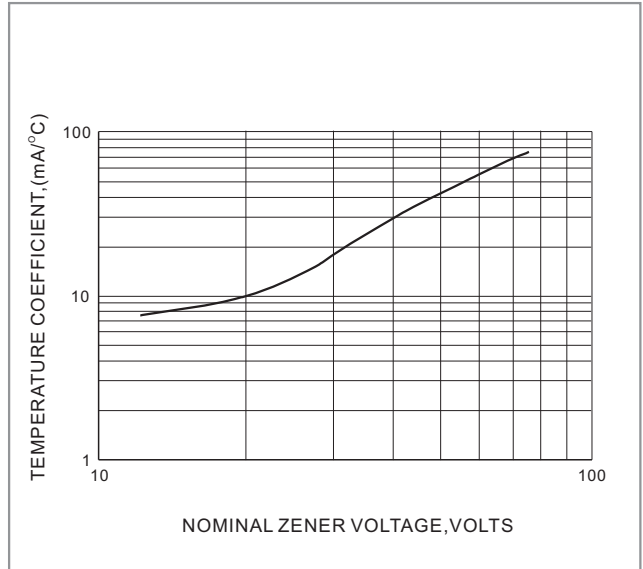

Fig.2 TEMPERATURE COEFFICIENTS

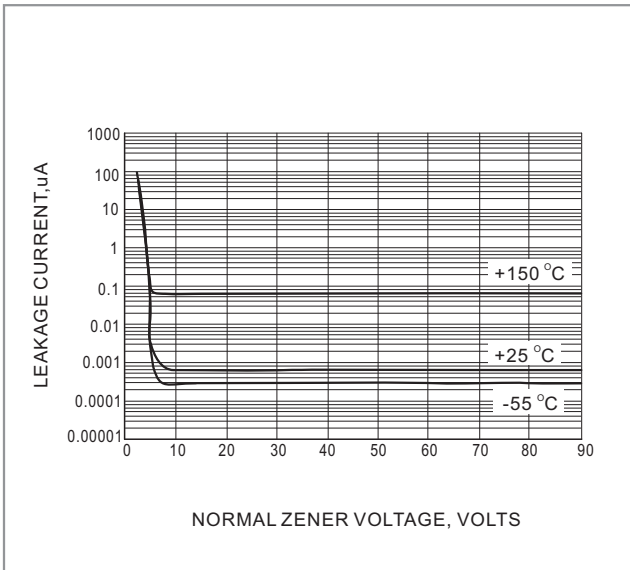

Fig.3 TYPICAL LEAKAGE CURRENT

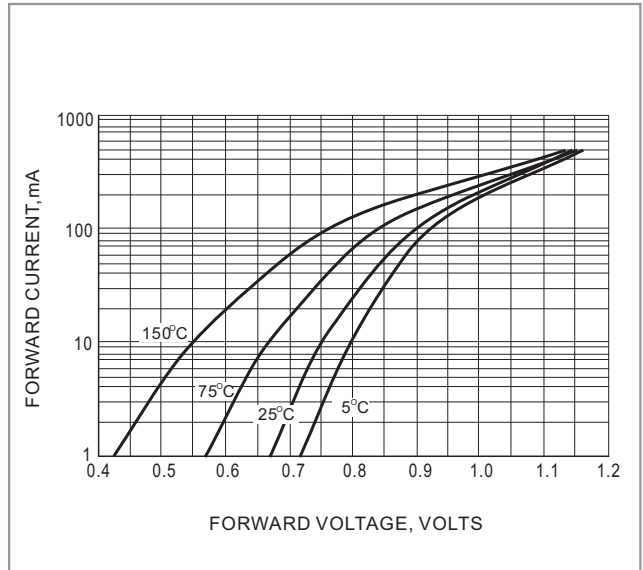

Fig.4 TYPICAL FORWARD VOLTAGE

## MMSZ5221BS ~ MMSZ5267BS Series

### Product and Packing Information

Part No.	Package Type	Packing Type	Marking
MMSZ52xxBS	SOD-323	5K pcs / 7" reel	See Table

### Mounting Pad Layout

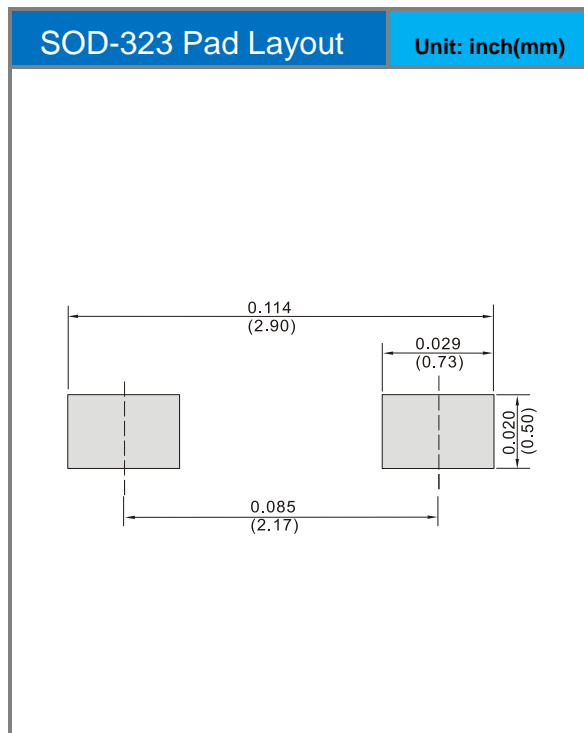

## MMSZ5221BS ~ MMSZ5267BS Series



---

### Disclaimer

- Reproducing and modifying information of the document is prohibited without permission from Panjit International Inc..
- Panjit International Inc. reserves the rights to make changes of the content herein the document anytime without notification. Please refer to our website for the latest document.
- Panjit International Inc. disclaims any and all liability arising out of the application or use of any product including damages incidentally and consequentially occurred.
- Panjit International Inc. does not assume any and all implied warranties, including warranties of fitness for particular purpose, non-infringement and merchantability.
- Applications shown on the herein document are examples of standard use and operation. Customers are responsible in comprehending the suitable use in particular applications. Panjit International Inc. makes no representation or warranty that such applications will be suitable for the specified use without further testing or modification.
- The products shown herein are not designed and authorized for equipments requiring high level of reliability or relating to human life and for any applications concerning life-saving or life-sustaining, such as medical instruments, transportation equipment, aerospace machinery et cetera. Customers using or selling these products for use in such applications do so at their own risk and agree to fully indemnify Panjit International Inc. for any damages resulting from such improper use or sale.
- Since Panjit uses lot number as the tracking base, please provide the lot number for tracking when complaining.

## Looking for pricing, stock, or lifecycle information?

Click below to explore more details on WIN SOURCE:

-  [View MMSZ5258BS\\_R1\\_00001 on WIN SOURCE](#)
-  [Panjit Information](#)

## Optimize Your Supply Chain with WIN SOURCE Solutions

-  Global Sourcing Solution
-  Obsolete Management
-  Cost Control Management
-  Shortage Management
-  Alternative Solution
-  Excess Inventory Management