



THE DATASHEET OF DMC2400UV



Product Summary

Device	BV _{DSS}	R _{DS(ON)} Max	I _D Max T _A = +25°C
Q1	20V	0.5Ω @ V _{GS} = 4.5V	1030mA
		0.9Ω @ V _{GS} = 1.8V	740mA
Q2	-20V	1.0Ω @ V _{GS} = -4.5V	-700mA
		2.0Ω @ V _{GS} = -1.8V	-460mA

Description

This new generation MOSFET has been designed to minimize the on-state resistance (R_{DS(ON)}) yet maintain superior switching performance, making it ideal for high efficiency power management applications.

Applications

- Power Management Functions
- Battery Operated Systems and Solid-State Relays
- Load Switch

Features and Benefits

- Low On-Resistance
- Low Gate Threshold Voltage V_{GS(TH)} < 1V
- Low Input Capacitance
- Fast Switching Speed
- Low Input/Output Leakage
- Complementary Pair MOSFET
- Ultra-Small Surface Mount Package
- **ESD Protected Gate**
- **Totally Lead-Free & Fully RoHS Compliant (Notes 1 & 2)**
- **Halogen and Antimony Free. "Green" Device (Note 3)**
- **For automotive applications requiring specific change control (i.e. parts qualified to AEC-Q100/101/200, PPAP capable, and manufactured in IATF 16949 certified facilities), please [contact us](mailto:contact@diodes.com) or your local Diodes representative.**
<https://www.diodes.com/quality/product-definitions/>

Mechanical Data

- Case: SOT563
- Case Material: Molded Plastic, "Green" Molding Compound. UL Flammability Classification Rating 94V-0
- Moisture Sensitivity: Level 1 per J-STD-020
- Terminal Connections: See Diagram
- Terminals: Finish – Matte Tin Annealed over Copper Leadframe. Solderable per MIL-STD-202, Method 208 (e3)
- Weight: 0.003 grams (Approximate)

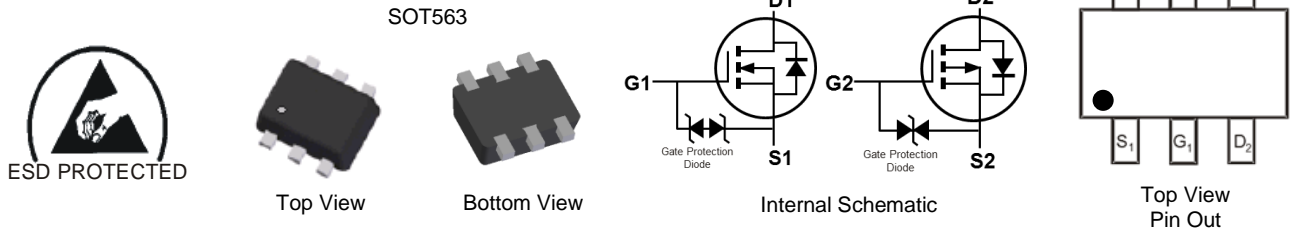

Ordering Information (Note 4)

Part Number	Case	Packaging
DMC2400UV-7	SOT563	3000/Tape & Reel
DMC2400UV-7B	SOT563	8000/Tape & Reel (Note 5)
DMC2400UV-13	SOT563	10000/Tape & Reel

- Notes:
1. No purposely added lead. Fully EU Directive 2002/95/EC (RoHS), 2011/65/EU (RoHS 2) & 2015/863/EU (RoHS 3) compliant.
 2. See <https://www.diodes.com/quality/lead-free/> for more information about Diodes Incorporated's definitions of Halogen- and Antimony-free, "Green" and Lead-free.
 3. Halogen- and Antimony-free "Green" products are defined as those which contain <900ppm bromine, <900ppm chlorine (<1500ppm total Br + Cl) and <1000ppm antimony compounds.
 4. For packaging details, go to our website at <https://www.diodes.com/design/support/packaging/diodes-packaging/>.
 5. Change the pitch from 4mm to 2mm in T&R.

Marking Information

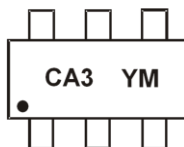

CA3 = Product Type Marking Code
 YM = Date Code Marking
 Y = Year (ex: H = 2020)
 M = Month (ex: 9 = September)

Date Code Key

Year	2011	...	2020	2021	2022	2023	2024	2025	2026	2027	2028	2029
Code	Y	...	H	I	J	K	L	M	N	O	P	R

Month	Jan	Feb	Mar	Apr	May	Jun	Jul	Aug	Sep	Oct	Nov	Dec
Code	1	2	3	4	5	6	7	8	9	O	N	D

Maximum Ratings - Q1 N-CHANNEL (@T_A = +25°C, unless otherwise specified.)

Characteristic			Symbol	Value	Unit
Drain-Source Voltage			V _{DSS}	20	V
Gate-Source Voltage			V _{GSS}	±12	V
Continuous Drain Current (Note 7) V _{GS} = 4.5V	Steady State	T _A = +25°C T _A = +70°C	I _D	1030 800	mA
	t < 10s	T _A = +25°C T _A = +70°C	I _D	1150 900	mA
Continuous Drain Current (Note 7) V _{GS} = 1.8V	Steady State	T _A = +25°C T _A = +70°C	I _D	740 570	mA
	t < 10s	T _A = +25°C T _A = +70°C	I _D	870 700	mA
Pulsed Drain Current (10µs Pulse, Duty Cycle = 1%)			I _{DM}	3	A
Maximum Body Diode Continuous Current			I _S	800	mA

Maximum Ratings - Q2 P-CHANNEL (@T_A = +25°C, unless otherwise specified.)

Characteristic			Symbol	Value	Unit
Drain-Source Voltage			V _{DSS}	-20	V
Gate-Source Voltage			V _{GSS}	±8	V
Continuous Drain Current (Note 7) V _{GS} = -4.5V	Steady State	T _A = +25°C T _A = +70°C	I _D	-700 -550	mA
	t < 10s	T _A = +25°C T _A = +70°C	I _D	-820 -640	mA
Continuous Drain Current (Note 7) V _{GS} = -1.8V	Steady State	T _A = +25°C T _A = +70°C	I _D	-460 -350	mA
	t < 10s	T _A = +25°C T _A = +70°C	I _D	-550 -420	mA
Pulsed Drain Current (10µs Pulse, Duty Cycle = 1%)			I _{DM}	-2	A
Maximum Body Diode Continuous Current			I _S	-800	mA

Thermal Characteristics (@T_A = +25°C, unless otherwise specified.)

Characteristic			Symbol	Value	Unit
Total Power Dissipation (Note 6)			P _D	0.45	W
Thermal Resistance, Junction to Ambient (Note 6)	Steady State		R _{θJA}	281	°C/W
	t < 10s		R _{θJA}	210	°C/W
Total Power Dissipation (Note 7)			P _D	1	W
Thermal Resistance, Junction to Ambient (Note 7)	Steady State		R _{θJA}	129	°C/W
	t < 10s		R _{θJA}	97	°C/W
Operating and Storage Temperature Range			T _J , T _{STG}	-55 to +150	°C

Notes: 6. Device mounted on FR-4 substrate PC board, 2oz copper, with minimum recommended pad layout.
7. Device mounted on FR-4 substrate PC board, 2oz copper, with 1inch square copper plate.

Electrical Characteristics - Q1 N-CHANNEL (@ $T_A = +25^\circ\text{C}$, unless otherwise specified.)

Characteristic	Symbol	Min	Typ	Max	Unit	Test Condition
OFF CHARACTERISTICS (Note 8)						
Drain-Source Breakdown Voltage	BV_{DSS}	20	—	—	V	$V_{GS} = 0V, I_D = 1mA$
Zero Gate Voltage Drain Current $T_J = +25^\circ\text{C}$	I_{DSS}	—	—	100	nA	$V_{DS} = 20V, V_{GS} = 0V$
Gate-Source Leakage	I_{GSS}	—	—	± 1	μA	$V_{GS} = \pm 5V, V_{DS} = 0V$
		—	—	± 4.0		$V_{GS} = \pm 8V, V_{DS} = 0V$
ON CHARACTERISTICS (Note 8)						
Gate Threshold Voltage	$V_{GS(TH)}$	0.5	—	0.9	V	$V_{DS} = V_{GS}, I_D = 250\mu\text{A}$
Static Drain-Source On-Resistance	$R_{DS(ON)}$	—	0.3	0.48	Ω	$V_{GS} = 5.0V, I_D = 200mA$
		—	0.35	0.5		$V_{GS} = 4.5V, I_D = 200mA$
		—	0.45	0.7		$V_{GS} = 2.5V, I_D = 200mA$
		—	0.55	0.9		$V_{GS} = 1.8V, I_D = 100mA$
		—	0.65	1.5		$V_{GS} = 1.5V, I_D = 50mA$
		—	2	—		$V_{GS} = 1.2V, I_D = 1mA$
		Forward Transfer Admittance	$ Y_{fs} $	—		1.4
Diode Forward Voltage	V_{SD}	—	0.7	1.2	V	$V_{GS} = 0V, I_S = 500mA$
DYNAMIC CHARACTERISTICS (Note 9)						
Input Capacitance	C_{iss}	—	37.1	—	pF	$V_{DS} = 10V, V_{GS} = 0V, f = 1.0MHz$
Output Capacitance	C_{oss}	—	6.5	—		
Reverse Transfer Capacitance	C_{rss}	—	4.8	—		
Gate Resistance	R_g	—	68	—	Ω	$V_{DS} = 0V, V_{GS} = 0V$
Total Gate Charge	Q_g	—	0.5	—	nC	$V_{GS} = 4.5V, V_{DS} = 10V, I_D = 250mA$
Gate-Source Charge	Q_{gs}	—	0.07	—		
Gate-Drain Charge	Q_{gd}	—	0.1	—		
Turn-On Delay Time	$t_{D(ON)}$	—	4.06	—	ns	$V_{DD} = 10V, V_{GS} = 4.5V, R_L = 47\Omega, R_G = 10\Omega, I_D = 200mA$
Turn-On Rise Time	t_r	—	7.28	—		
Turn-Off Delay Time	$t_{D(OFF)}$	—	13.74	—		
Turn-Off Fall Time	t_f	—	10.54	—		

Notes: 8. Short duration pulse test used to minimize self-heating effect.
 9. Guaranteed by design. Not subject to product testing.

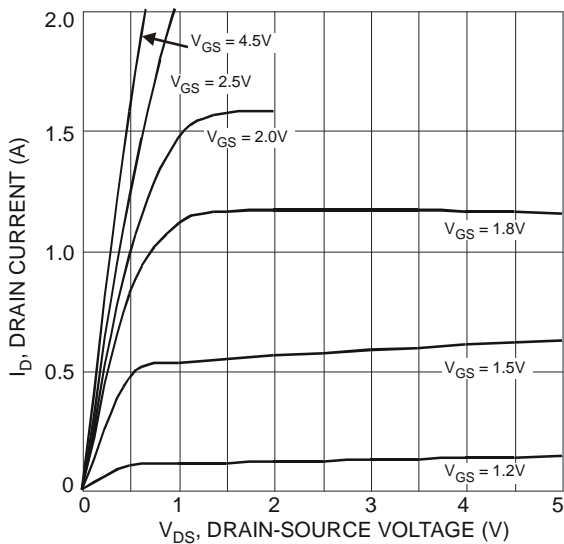

Fig. 1 Typical Output Characteristics

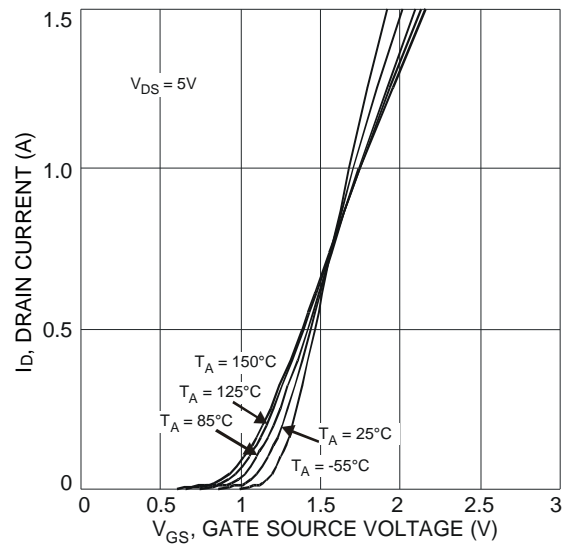

Fig. 2 Typical Transfer Characteristics

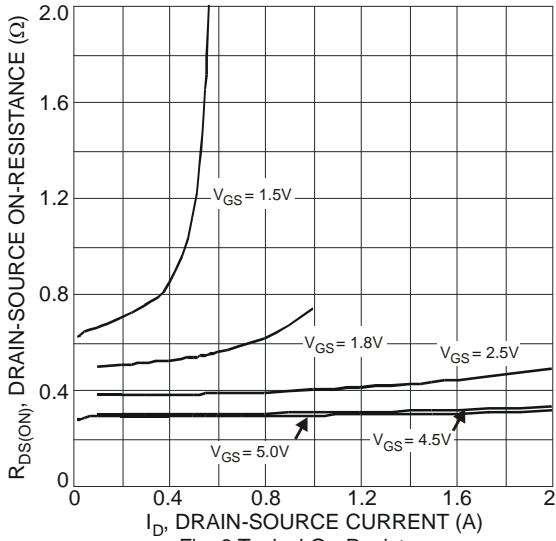

Fig. 3 Typical On-Resistance vs. Drain Current and Gate Voltage

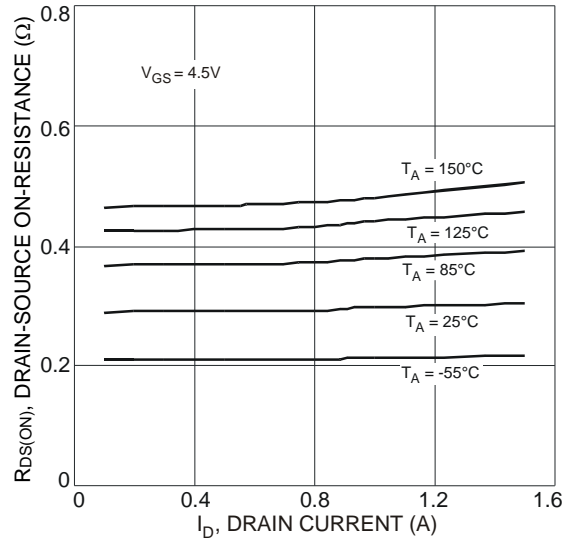

Fig. 4 Typical Drain-Source On-Resistance vs. Drain Current and Temperature

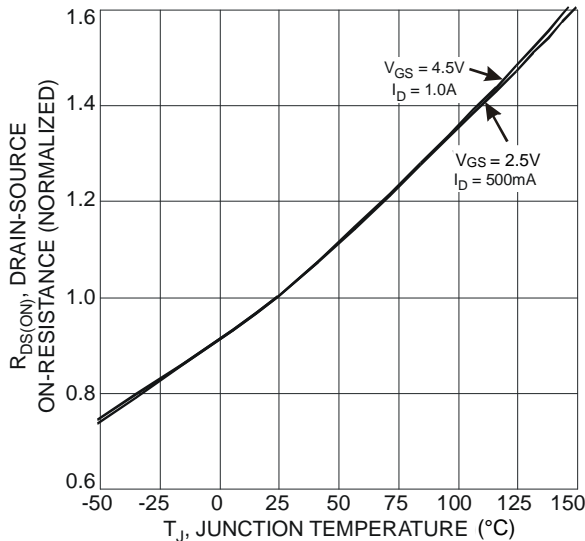

Fig. 5 On-Resistance Variation with Temperature

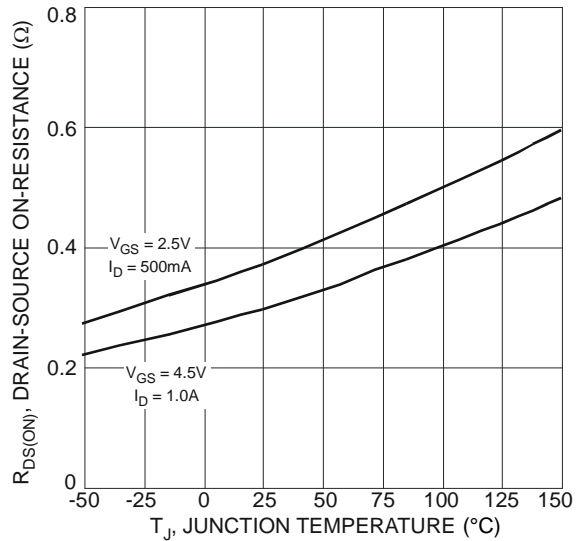

Fig. 6 On-Resistance Variation with Temperature

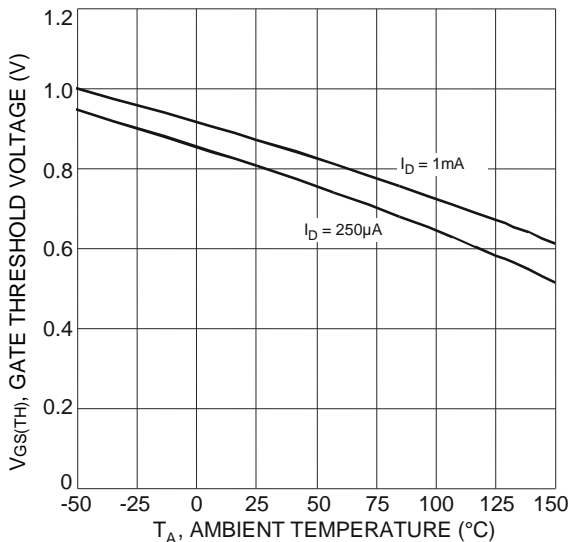

Fig. 7 Gate Threshold Variation vs. Ambient Temperature

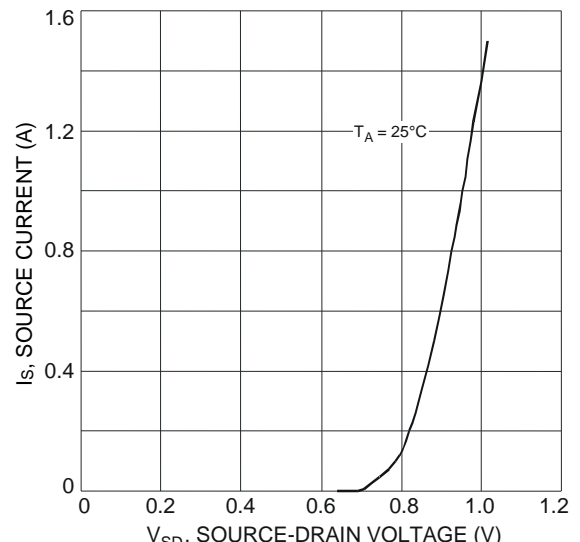
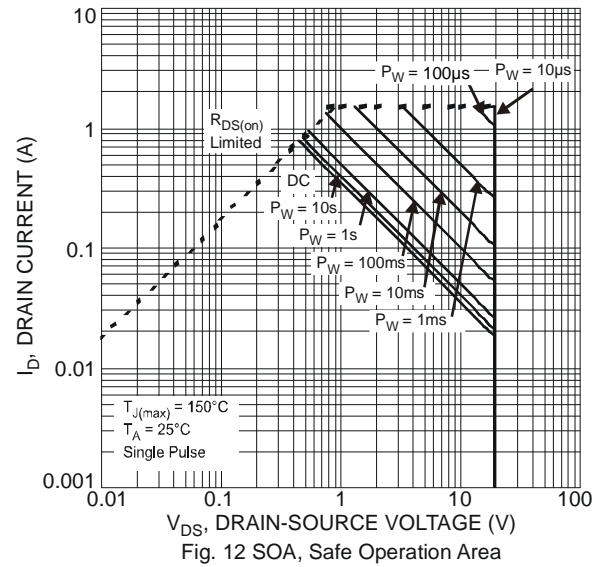
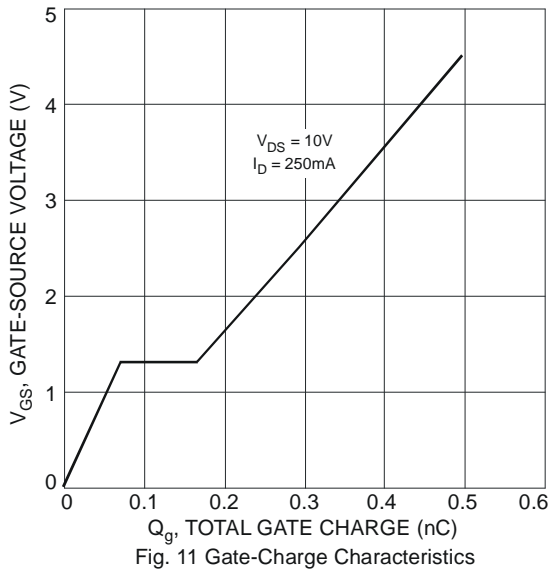
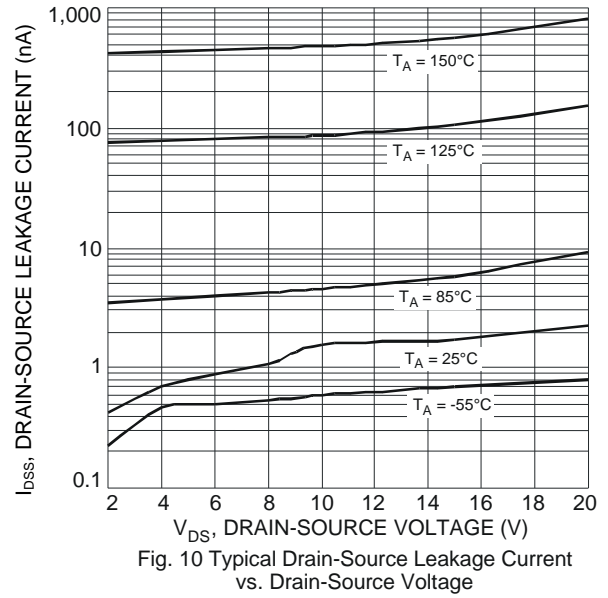
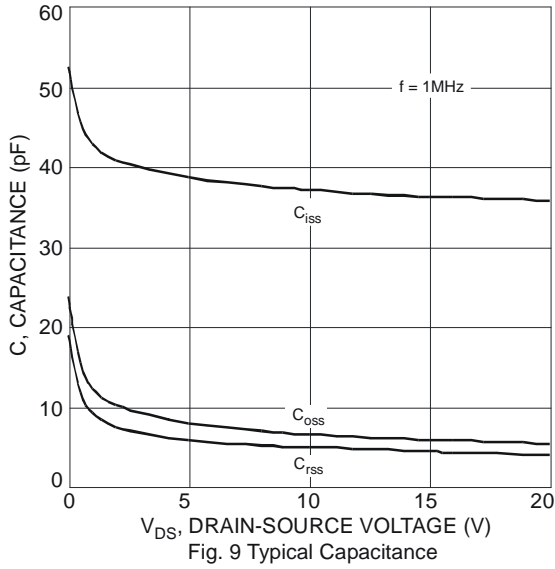

Fig. 8 Diode Forward Voltage vs. Current



Electrical Characteristics - Q2 P-CHANNEL (@T_A = +25°C, unless otherwise specified.)

Characteristic	Symbol	Min	Typ	Max	Unit	Test Condition
OFF CHARACTERISTICS (Note 8)						
Drain-Source Breakdown Voltage	BV _{DSS}	-20	—	—	V	V _{GS} = 0V, I _D = -1mA
Zero Gate Voltage Drain Current T _J = +25°C	I _{DSS}	—	—	-100	nA	V _{DS} = -20V, V _{GS} = 0V
Gate-Source Leakage	I _{GSS}	—	—	±1.0	µA	V _{GS} = ±5V, V _{DS} = 0V
		—	—	±5.0		V _{GS} = ±8V, V _{DS} = 0V
ON CHARACTERISTICS (Note 8)						
Gate Threshold Voltage	V _{GS(TH)}	-0.5	—	-1.0	V	V _{DS} = V _{GS} , I _D = -250µA
Static Drain-Source On-Resistance	R _{DS(ON)}	—	0.67	0.97	Ω	V _{GS} = -5V, I _D = -100mA
		—	0.7	1.0		V _{GS} = -4.5V, I _D = -100mA
		—	0.9	1.5		V _{GS} = -2.5V, I _D = -80mA
		—	1.2	2.0		V _{GS} = -1.8V, I _D = -40mA
		—	1.5	3.0		V _{GS} = -1.5V, I _D = -30mA
		—	5	—		V _{GS} = -1.2V, I _D = -1mA
		—	—	—		—
Forward Transfer Admittance	Y _{fs}	—	0.7	—	S	V _{DS} = -3V, I _D = -100mA
Diode Forward Voltage	V _{SD}	—	-0.75	-1.2	V	V _{GS} = 0V, I _S = -330mA
DYNAMIC CHARACTERISTICS (Note 9)						
Input Capacitance	C _{iss}	—	46.1	—	pF	V _{DS} = -10V, V _{GS} = 0V, f = 1.0MHz
Output Capacitance	C _{oss}	—	7.2	—		
Reverse Transfer Capacitance	C _{rss}	—	4.9	—		
Gate Resistance	R _g	—	14.3	—	Ω	V _{DS} = 0V, V _{GS} = 0V
Total Gate Charge (V _{GS} = -4.5V)	Q _g	—	0.5	—	nC	V _{DS} = -10V, I _D = -250mA
Total Gate Charge (V _{GS} = -10V)	Q _g	—	0.85	—		
Gate-Source Charge	Q _{gs}	—	0.09	—		
Gate-Drain Charge	Q _{gd}	—	0.09	—		
Turn-On Delay Time	t _{D(ON)}	—	8.5	—	ns	V _{DD} = -3V, V _{GS} = -2.5V, R _L = 300Ω, R _G = 25Ω, I _D = -100mA
Turn-On Rise Time	t _R	—	4.3	—		
Turn-Off Delay Time	t _{D(OFF)}	—	20.2	—		
Turn-Off Fall Time	t _F	—	19.2	—		

Notes: 8. Short duration pulse test used to minimize self-heating effect.
 9. Guaranteed by design. Not subject to product testing.

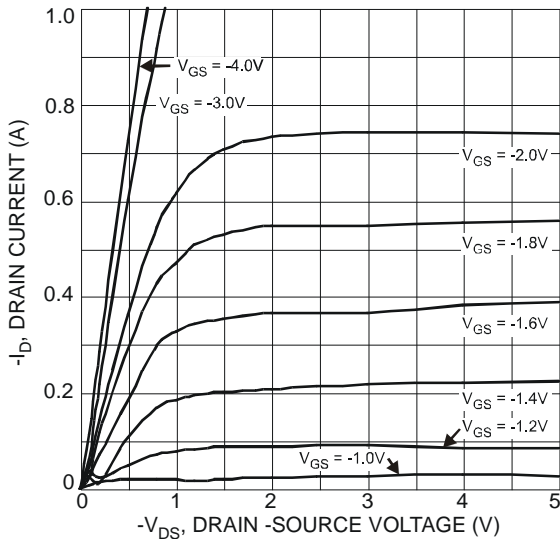

Fig. 13 Typical Output Characteristics

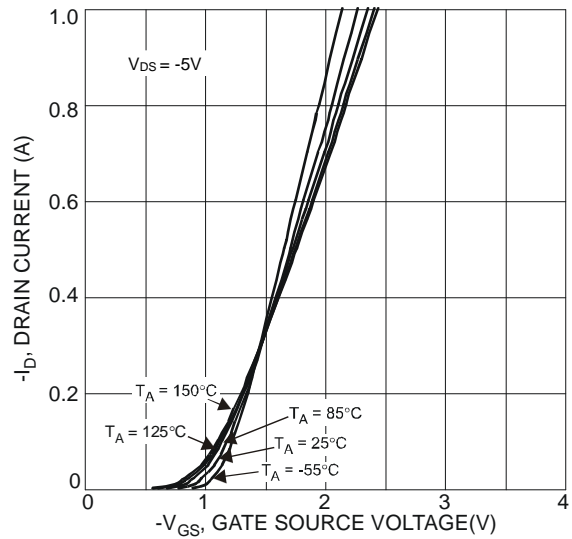

Fig. 14 Typical Transfer Characteristics

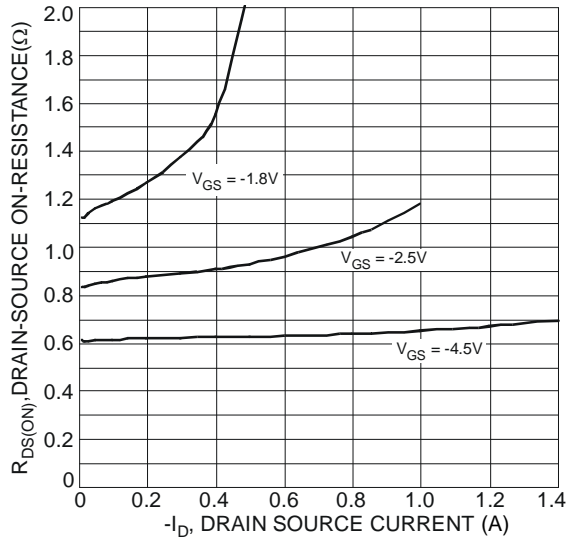

Fig. 15 Typical On-Resistance vs. Drain Current and Gate Voltage

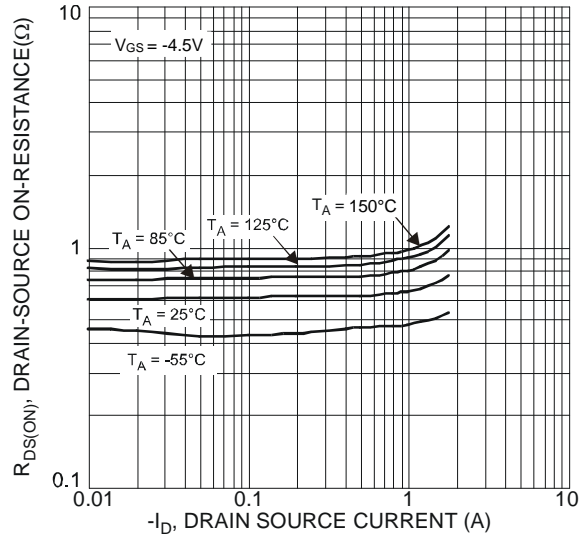

Fig. 16 Typical On-Resistance vs. Drain Current and Temperature

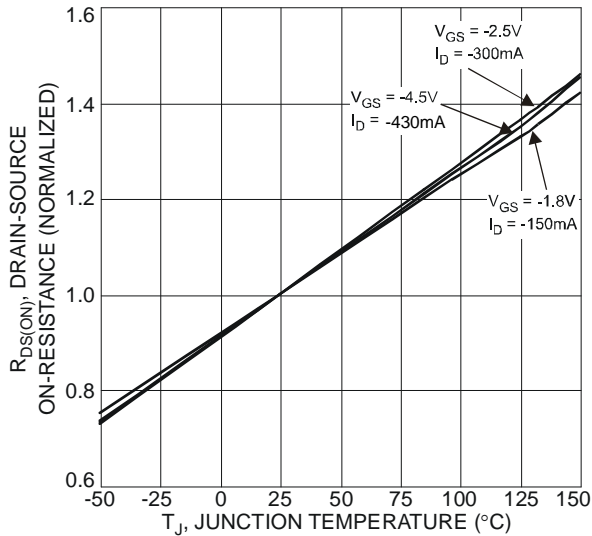

Fig. 17 On-Resistance Variation with Temperature

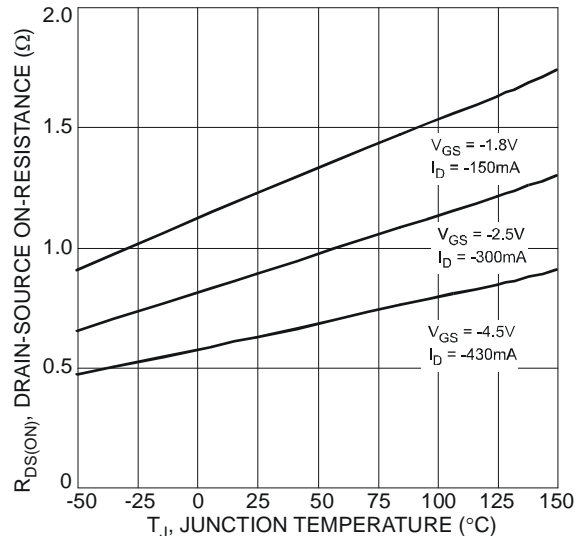

Fig. 18 On-Resistance vs. Temperature

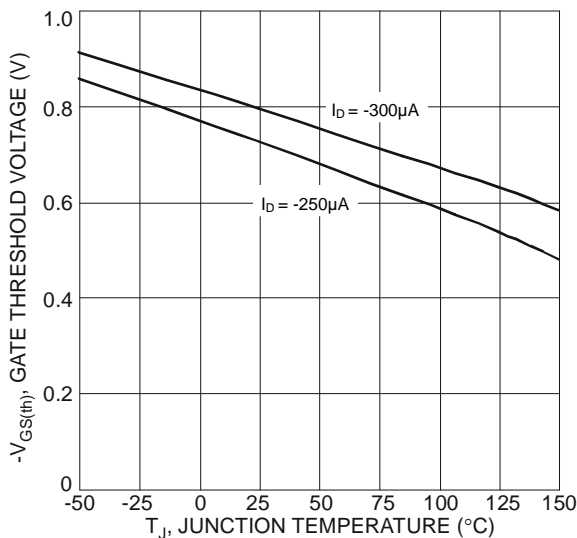

Fig. 19 Gate Threshold Voltage vs. Junction Temperature

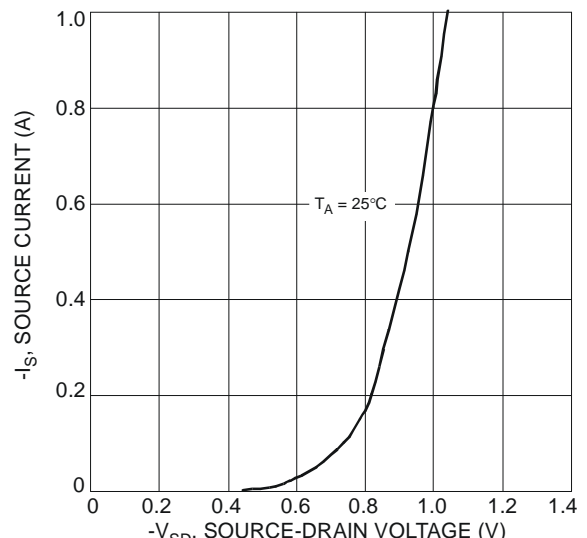

Fig. 20 Diode Forward Voltage vs. Current

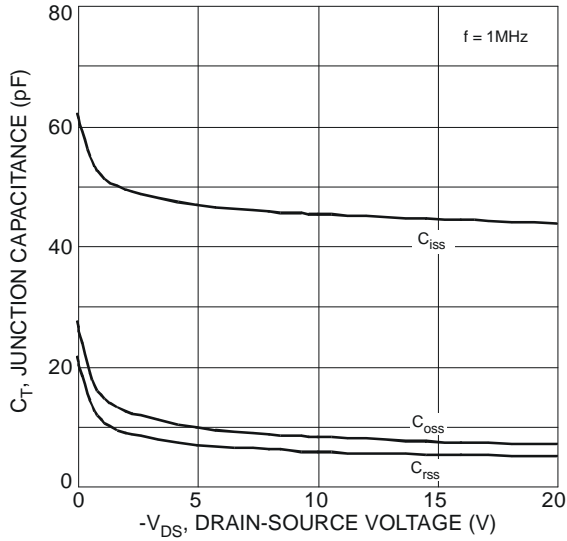

Fig. 21 Typical Junction Capacitance

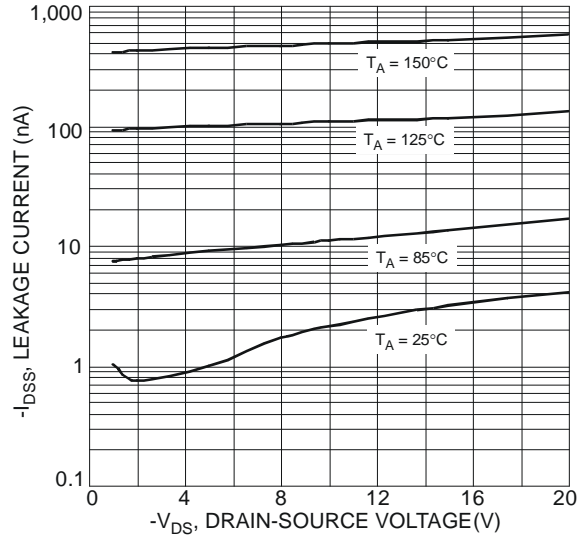

Fig. 22 Typical Drain-Source Leakage Current vs. Voltage

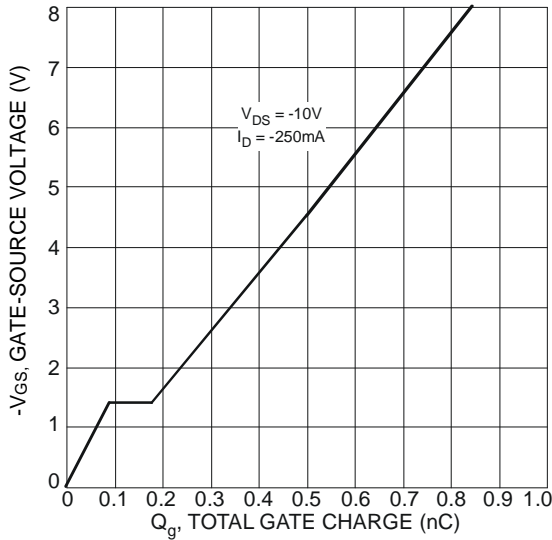

Fig. 23 Gate-Charge Characteristics

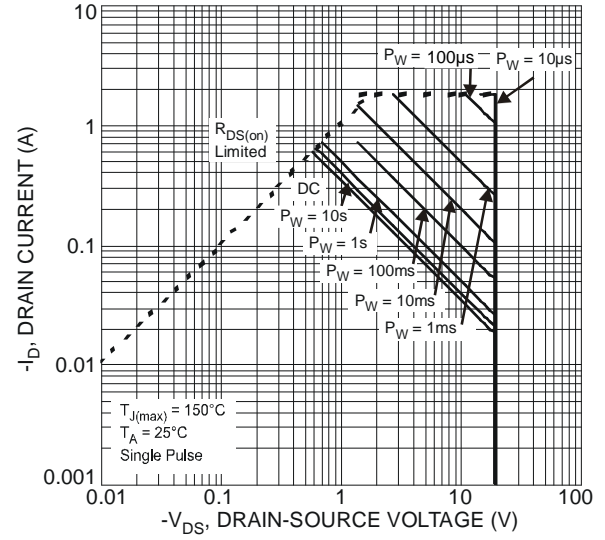

Fig. 24 SOA, Safe Operation Area

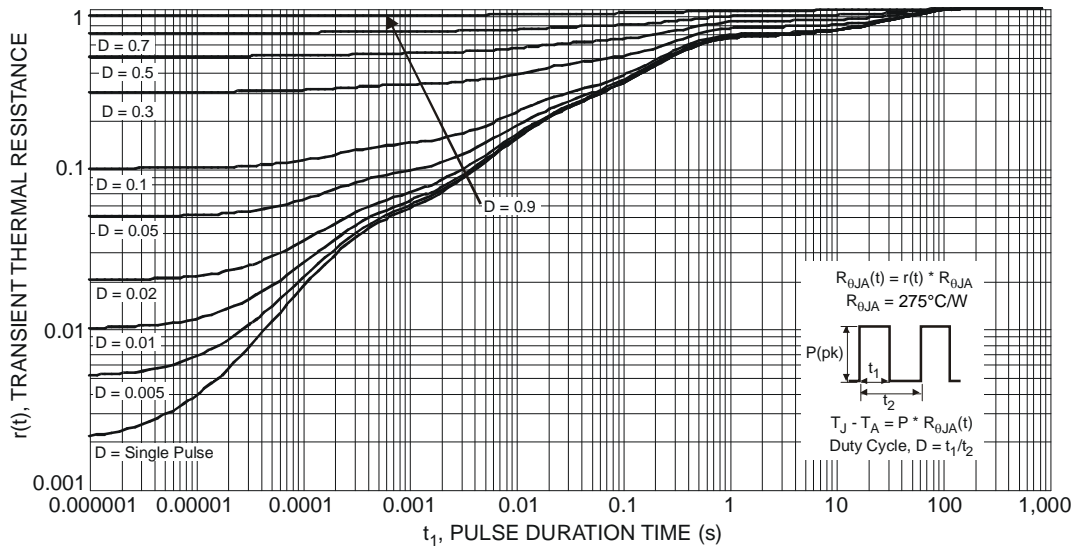
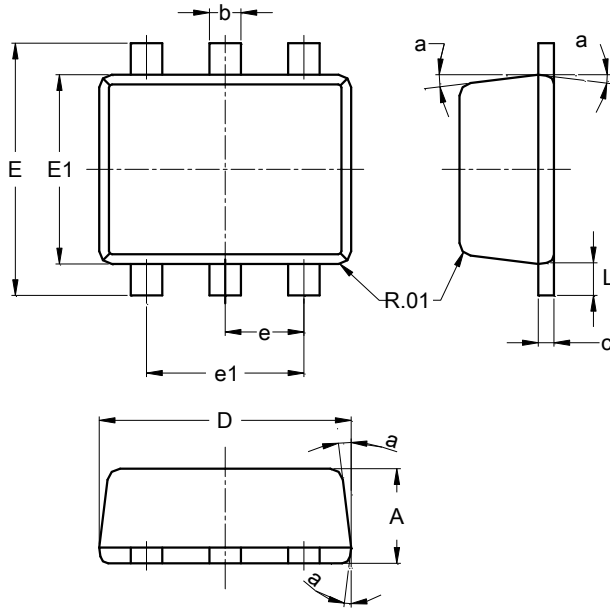

Fig. 25 Transient Thermal Response

Package Outline Dimensions

Please see <http://www.diodes.com/package-outlines.html> for the latest version.

SOT563



SOT563			
Dim	Min	Max	Typ
A	0.55	0.60	0.60
b	0.15	0.30	0.20
c	0.10	0.18	0.11
D	1.50	1.70	1.60
E	1.55	1.70	1.60
E1	1.10	1.25	1.20
e	--	--	0.50
e1	0.90	1.10	1.00
L	0.10	0.30	0.20
a	8°	9°	7°
All Dimensions in mm			

Suggested Pad Layout

Please see <http://www.diodes.com/package-outlines.html> for the latest version.

SOT563

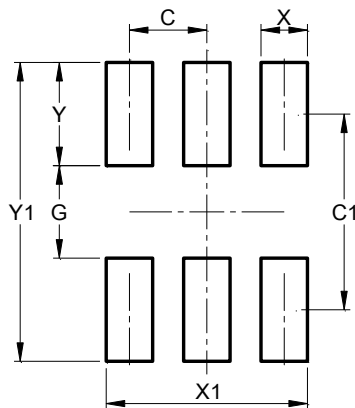

Dimensions	Value (in mm)
C	0.500
C1	1.270
G	0.600
X	0.300
X1	1.300
Y	0.670
Y1	1.940

IMPORTANT NOTICE

DIODES INCORPORATED MAKES NO WARRANTY OF ANY KIND, EXPRESS OR IMPLIED, WITH REGARDS TO THIS DOCUMENT, INCLUDING, BUT NOT LIMITED TO, THE IMPLIED WARRANTIES OF MERCHANTABILITY AND FITNESS FOR A PARTICULAR PURPOSE (AND THEIR EQUIVALENTS UNDER THE LAWS OF ANY JURISDICTION).

Diodes Incorporated and its subsidiaries reserve the right to make modifications, enhancements, improvements, corrections or other changes without further notice to this document and any product described herein. Diodes Incorporated does not assume any liability arising out of the application or use of this document or any product described herein; neither does Diodes Incorporated convey any license under its patent or trademark rights, nor the rights of others. Any Customer or user of this document or products described herein in such applications shall assume all risks of such use and will agree to hold Diodes Incorporated and all the companies whose products are represented on Diodes Incorporated website, harmless against all damages.

Diodes Incorporated does not warrant or accept any liability whatsoever in respect of any products purchased through unauthorized sales channel. Should Customers purchase or use Diodes Incorporated products for any unintended or unauthorized application, Customers shall indemnify and hold Diodes Incorporated and its representatives harmless against all claims, damages, expenses, and attorney fees arising out of, directly or indirectly, any claim of personal injury or death associated with such unintended or unauthorized application.

Products described herein may be covered by one or more United States, international or foreign patents pending. Product names and markings noted herein may also be covered by one or more United States, international or foreign trademarks.

This document is written in English but may be translated into multiple languages for reference. Only the English version of this document is the final and determinative format released by Diodes Incorporated.

LIFE SUPPORT

Diodes Incorporated products are specifically not authorized for use as critical components in life support devices or systems without the express written approval of the Chief Executive Officer of Diodes Incorporated. As used herein:

A. Life support devices or systems are devices or systems which:

1. are intended to implant into the body, or
2. support or sustain life and whose failure to perform when properly used in accordance with instructions for use provided in the labeling can be reasonably expected to result in significant injury to the user.

B. A critical component is any component in a life support device or system whose failure to perform can be reasonably expected to cause the failure of the life support device or to affect its safety or effectiveness.



Customers represent that they have all necessary expertise in the safety and regulatory ramifications of their life support devices or systems, and acknowledge and agree that they are solely responsible for all legal, regulatory and safety-related requirements concerning their products and any use of Diodes Incorporated products in such safety-critical, life support devices or systems, notwithstanding any devices- or systems-related information or support that may be provided by Diodes Incorporated. Further, Customers must fully indemnify Diodes Incorporated and its representatives against any damages arising out of the use of Diodes Incorporated products in such safety-critical, life support devices or systems.

Copyright © 2020, Diodes Incorporated

www.diodes.com

Looking for pricing, stock, or lifecycle information?

Click below to explore more details on WIN SOURCE:

-  [View DMC2400UV](#) on WIN SOURCE
-  [Diodes Incorporated](#) Information

Optimize Your Supply Chain with WIN SOURCE Solutions

-  Global Sourcing Solution
-  Obsolete Management
-  Cost Control Management
-  Shortage Management
-  Alternative Solution
-  Excess Inventory Management