





THE DATASHEET OF SD08C



SPECIFICATION SHEET

SPECIFICATION SHEET NO.	N1004- SOD323SD08CS2C
DATE	Oct. 04, 2021
REVISION	A0
DESCRIPTION	<p>SMD Plastic-Encapsulate ESD Protection Diodes, SOD-323 series, 2 pads SD08C Type, Bi-directional Channels Reverse Working Voltage : 8V, Clamping Voltage 13.4VC Max.@1.0A</p> <p>Operating Temp. Range -55°C ~+150°C, Package in Tape/Reel, 3000pcs/Reel RoHS/RoHS III compliant</p>
CUSTOMER	
CUSTOMER PART NUMBER	
CROSS REF. PART NUMBER	
ORIGINAL PART NUMBER	MDD SD8C
PART CODE	SOD323SD08CS2C

VENDOR APPROVE			
Issued/Checked/Approved			
DATE: Oct. 04, 2021			

CUSTOMER APPROVE	
DATE:	

SMD ESD PROTECTION DIODES SOD-323 SERIES

MAIN FEATURE

- Peak power dissipation 350W (8/20μs)
- IEC61000-4-2 (ESD) ±15kV (air), ±8kV (contact)
- IEC61000-4-4 (EFT) 40A (5/50ns)
- Protects one data I/O line (Bi-directional)
- Low clamping voltage
- Low leakage current
- Working Voltage 3.3V/5V/8V/12V/15V/18V/20V/24V/36V
- Meet MSL 1 requirement



APPLICATION

- Cell phone handsets and accessories
- Serial and parallel pots
- Notebooks, Desktops, and Servers Cellular
- Microprocessor based equipment
- Networking and Telecom
- Portable Instrumentation
- Personal Digital Assistants (PDA's)
- Peripherals

RFQ
Request For Quotation

PART CODE GUIDE

SOD323	SD08C	S	2C
1	2	3	4

- 1) **SOD323**: SMD Plastic-Encapsulate ESD Protection Diodes, SOD-323 series, 2 pads
- 2) **SD08C**: Type code for original part number SD08C
- 3) **S**: Package code, Package in Tape/Reel, 3000pcs/Reel
- 4) **2C**: Marking code for "2C" on the case surface, Different Marking for different specification.

SMD ESD PROTECTION DIODES SOD-323 SERIES

DIMENSION (Unit: Inch/mm)

Image for reference



Marking: 2C

SOD-323

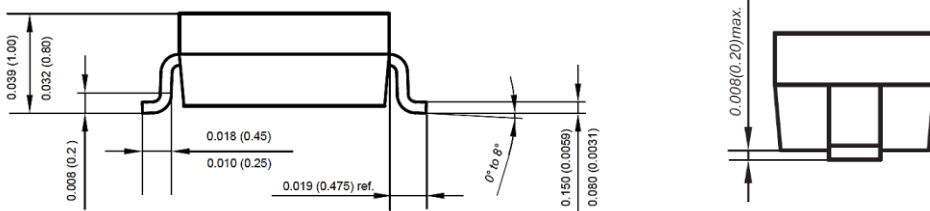
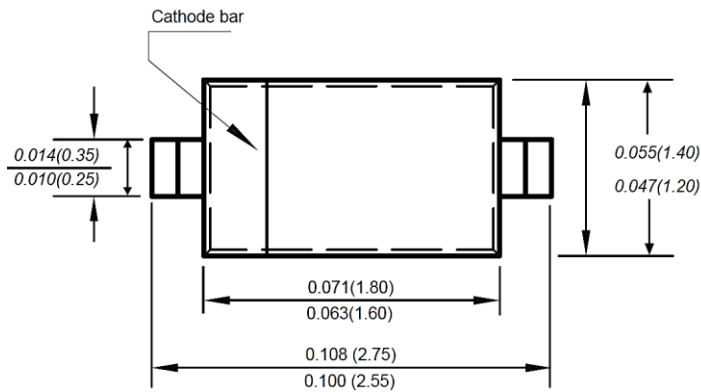

Recommend Pad Layout

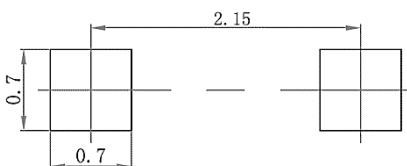

Circuit Diagram

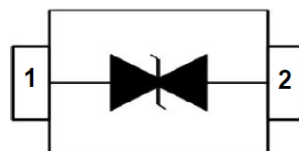

SMD ESD PROTECTION DIODES SOD-323 SERIES
MECHANICAL DATA

Case	Flammability Rating	Terminals	Mounting Position	Weight per piece
JEDEC SOT-323 molded plastic body	UL 94V-0	Matte tin plated	-	-

ABSOLUTE MAX. RATINGS AT Ta=25 °C (unless otherwise specified)

Parameter	SYMBOLS	VALUE	UNITS
		LIMIT	
ESD per IEC 61000-4-2 (Air)	V ESD	+/-15	KV
ESD per IEC 61000-4-2 (Contact)	V ESD	+/-8	KV
Peak Pulse Power @8/20µs	P PP	350	W
Operating Temperature Range	T J	-55 ~+ 150	°C
Storage Temperature Range	T STG	-55 ~ +150	°C
Lead Solder Temperature- Max. (10 s Duration)	T L	260 /10s	°C

SMD ESD PROTECTION DIODES SOD-323 SERIES

ELECTRICAL CHARACTERISTICS (Ta=25 °C unless otherwise specified)

Parameter	SYMBOLS	VALUE			UNITS
		Min.	Typical	Max.	
Reverse Working Voltage	V _{RWM}			8	V
Reverse Breakdown Voltage @ I _T = 1.0mA	V _{BR}	8.5			V
Reverse Leakage Current @ V _{RWM} = 8V	I _R			2.0	μA
Clamping Voltage @ I _{PP} = 1.0A, t _p = 8/20μs	V _C			13.4	V
Clamping Voltage @ I _{PP} = 15A, t _p = 8/20μs	V _C			24	V
Junction Capacitance @ V _R = 0V, f = 1MHz	C _J			120	pF

SMD ESD PROTECTION DIODES SOD-323 SERIES
RELIABILITY

Number	Experiment Items	Experiment Method And Conditions	Reference Documents
1	Solder Resistance Test	Test 260°C± 5°C for 10 ± 2 sec. Immerse body into solder 1/16" ± 1/32"	MIL-STD-750D METHOD-2031.2
2	Solderability Test	230°C ±5°C for 5 sec.	MIL-STD-750D METHOD-2026.1 0
3	Pull Test	1 kg in axial lead direction for 10 sec.	MIL-STD-750D METHOD-2036.4
4	Bend Test	0.5Kg Weight Applied To Each Lead, Bending Arcs 90 °C ± 5 °C For 3 Times	MIL-STD-750D METHOD-2036.4
5	High Temperature Reverse Bias Test	TA=100°C for 1000 Hours at VR=80% Rated VR	MIL-STD-750D METHOD-1038.4
6	Forward Operation Life Test	TA=25°C Rated Average Rectified Current	MIL-STD-750D METHOD-1027.3
7	Intermittent Operation Life Test	On state: 5 min with rated IRMS Power Off state: 5 min with Cool Forced Air. On and off for 1000 cycles.	MIL-STD-750D METHOD-1036.3
8	Pressure Cooker Test	15 PSIG, TA=121°C, 4 hours	MIL-S-19500 APPENOIXC
9	Temperature Cycling Test	-55°C~+125°C; 30 Minutes For Dwelled Time 5 minutes for transferred time. Total: 10 cycles.	MIL-STD-750D METHOD-1051.7
10	Thermal Shock Test	0°C for 5 minutes., 100°C for 5minutes, Total: 10 cycles	MIL-STD-750D METHOD-1056.7
11	Forward Surge Test	8.3ms Single Sale Sine-wave One Surge.	MIL-STD-750D METHOD-4066.4
12	Humidity Test	TA=65°C, RH=98% for 1000 hours.	MIL-STD-750D METHOD-1021.3
13	High Temperature Storage life Test	150°C for 1000 Hours	MIL-STD-750D METHOD-1031.5

SMD ESD PROTECTION DIODES SOD-323 SERIES

SUGGESTED REFLOW PROFILE (For Reference Only)

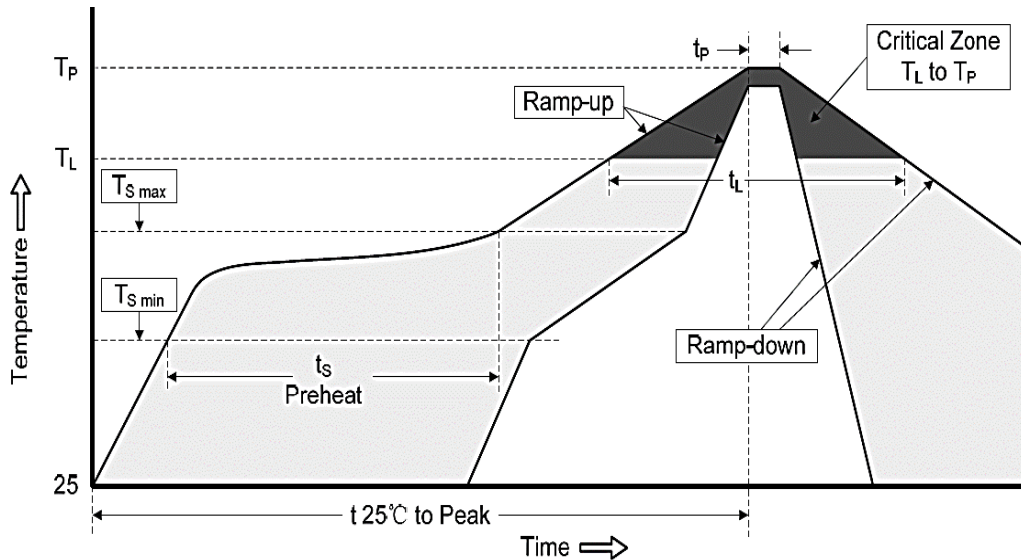

Profile Feature		Pb-Free Assembly
Average Ramp-up Rate (Ts Max to Tp)		3°C/second Max
Preheat	Temperature Min (Ts Min.)	150°C
	Temperature Max (Ts Max.)	200°C
	Time (ts Min. to ts Max.)	60 ~ 180 seconds
Time maintained above	Temperature (Tl)	217°C
	Time (ti)	60 ~ 150 seconds
Peak/Classification Temperature (Tp)		260 °C
Time within 5°C of actual Peak Temperature (tp)		20 ~ 40 seconds
Ramp-down rate		6 °C /Second Max.
Time 25 °C to Peak Temperature		8 minutes Max.
Suggest reflow times		3 Times Max.

SMD ESD PROTECTION DIODES SOD-323 SERIES

RATINGS AND CHARACTERISTIC CURVES (For Reference Only)

Fig 1 8/20 μ s Waveform per IEC61000-4-5

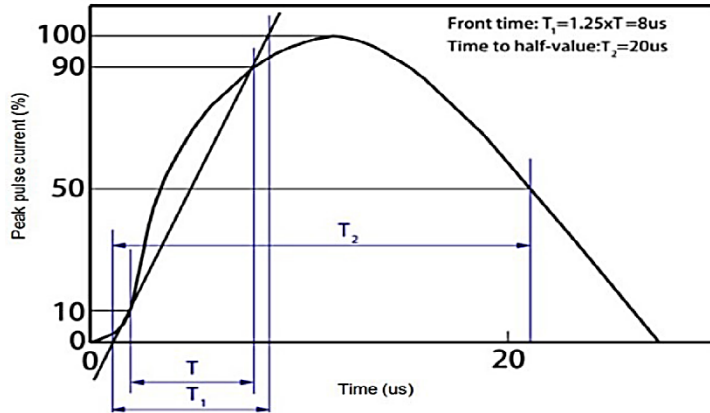

Fig 2 Contact Discharge Current Waveform per IEC 61000-4-2)

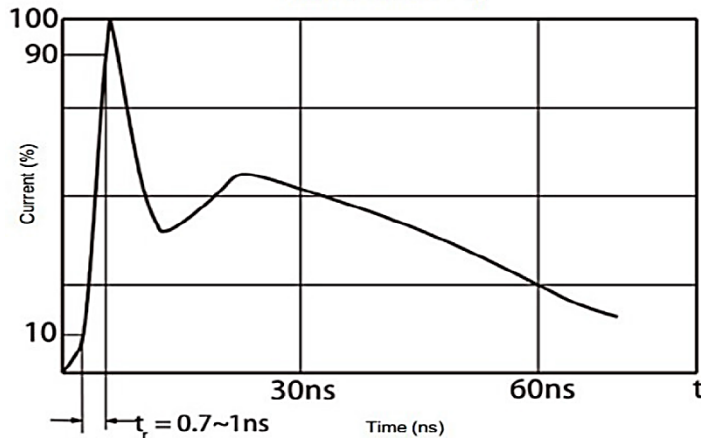
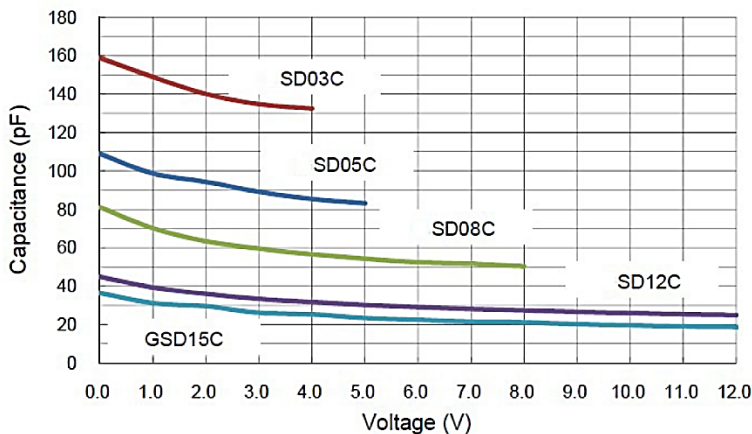

Fig 3 Voltage vs Capacitance



SMD ESD PROTECTION DIODES SOD-323 SERIES

RATINGS AND CHARACTERISTIC CURVES (For Reference Only)

Fig 4 Voltage vs Capacitance

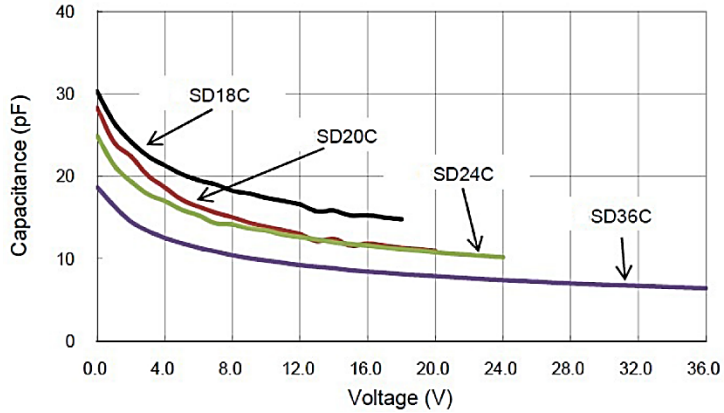

Fig 5 Clamping Voltage vs Peak Pulse Current

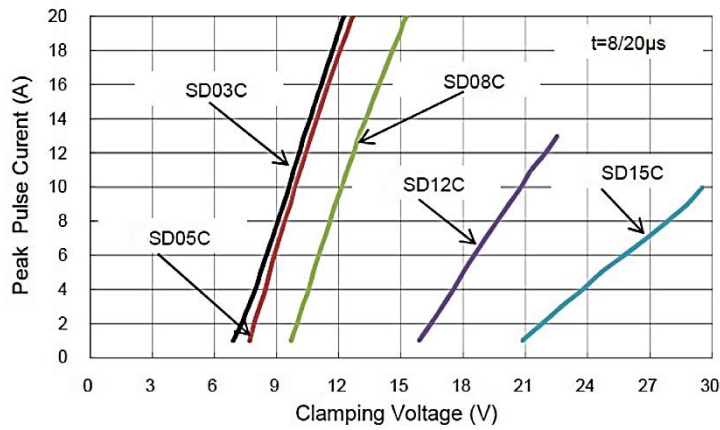
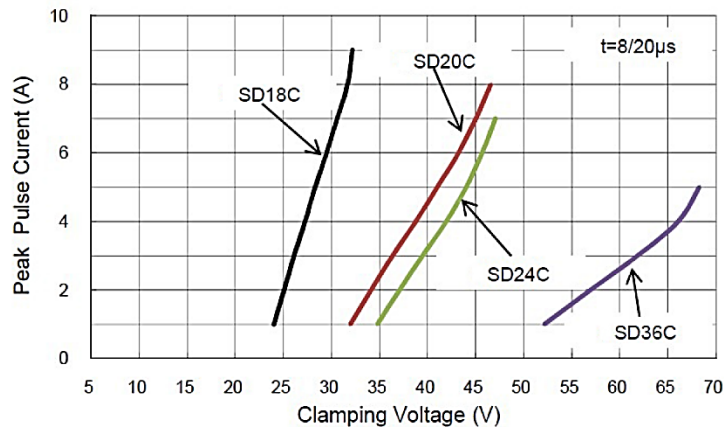

Fig 6 Clamping Voltage vs Peak Pulse Current



SMD ESD PROTECTION DIODES SOD-323 SERIES

TAPE/REEL (Unit: mm)

All Devices are packed in accordance with EIA standard RS-481-A and specifications.

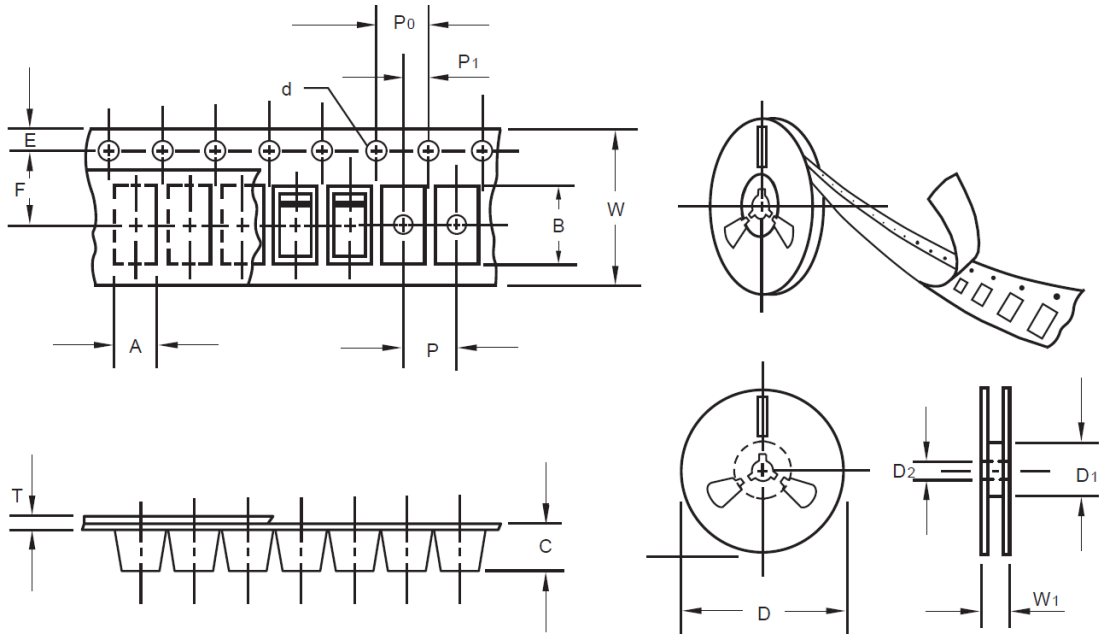

Item	Symbol	Tolerance	SO-323
Carrier width	A	0.1	1.46
Carrier Length	B	0.1	2.90
Carrier Depth	C	0.1	1.25
Sprocket hole	d	0.05	1.55
7"Reel outside diameter	D	2.0	178.00
7"Reel inner diameter	D1	Min.	50.00
Feed hole diameter	D2	0.5	13.00
Sprocket hole position	E	0.1	1.75
Punch hole position	F	0.1	3.50
Punch hole pitch	P	0.1	4.00
Sprocket hole pitch	P0	0.1	4.00
Embossment center	P1	0.1	2.00
Overall tape thickness	T	0.1	0.06
Tape width	W	0.3	8.00
Reel width	W1	1.0	12.30

SMD ESD PROTECTION DIODES SOD-323 SERIES

SPQ PACKAGE for Reference



Item	Unit	Value
Case Code		SOD-323
Reel Size	Inch	7
Reel Size	mm	178
Tape Space	mm	/
SPQ /Reel	pcs	3000
Weigh /SPQ	LBS	-
Weigh /SPQ	KGs	-
Qty. Per Box	pcs	6,000
Inner Box	Inch	L8.0*W8.0*H1.5

DISCLAIMER





NextGen Component, Inc. reserves the right to make changes to the product(s) and or information contained herein without notice. No liability is assumed as a result of their use or application. No rights under any patent accompany the sale of any such product(s) or information

Looking for pricing, stock, or lifecycle information?

Click below to explore more details on WIN SOURCE:

-  [View SD08C on WIN SOURCE](#)
-  [MDD Information](#)

Optimize Your Supply Chain with WIN SOURCE Solutions

-  Global Sourcing Solution
-  Obsolete Management
-  Cost Control Management
-  Shortage Management
-  Alternative Solution
-  Excess Inventory Management