



THE DATASHEET OF UM7222



High-Speed USB2.0 (480 Mbps) DPDT Switch**UM7222MA MSOP10**
UM7222 QFN10 1.8×1.4**General Description**

The UM7222MA/UM7222 is a dual port high-speed, low-power data switch optimized for USB 2.0 signal switching. The UM7222MA/UM7222 switch is configured in double-pole/double-throw DPDT. It handles bidirectional signal flow, achieving a 550 MHz -3dB bandwidth, and a port to port crosstalk and isolation at -50dB at 250MHz.

The UM7222MA/UM7222 operates from a single +2.7V to +5.5V supply, with current consumption less than 1 microampere.

The UM7222MA/UM7222 features wide bandwidth and low bit-to-bit skew allow it to pass high-speed differential signal with good signal integrity, offers little or no attenuation of the high-speed signals at the outputs. Its high channel-to-channel crosstalk rejection results in minimal noise interface. Its bandwidth is wide enough to pass high-speed USB 2.0 differential signals (480Mbps). The control logic threshold is guaranteed to be compatible with 1.8V logic.

The UM7222MA is available in Pb-free MSOP10 package, while the UM7222 is available in Pb-free QFN10 package (1.4mm×1.8mm×0.55mm). They are ideal for portable high speed mix signal switching application.

Applications

- Differential Signal Data Routing
- USB2.0 Signal Routing
- Cell Phone, PDA, Digital Camera and Notebook
- LCD Monitor, TV and Set-Top Box

Features

- Ron is Typically 6.5Ω at V_{CC}=3.0V
- Low Bit-to-Bit Skew: Typically 50ps
- OVT on D+ and D- up to 5.5V
- Power OFF Protection:
When V_{CC}=0V, D+ and D- can Tolerate up to 5.5V
- Low Crosstalk: -50dB (250MHz)
- Low Current Consumption: 1μA
- Near-Zero Propagation Delay: 250ps
- Channel On-Capacitance: 6.5pF(Typical)
- V_{CC} Operating Range: +2.7V to +5.5V
- 550MHz Bandwidth (or Data Frequency)
- Lead (Pb)-Free MSOP10 and QFN10 Packages
- ESD Rating: ±4kV I/O to GND

Pin Configurations

Top View

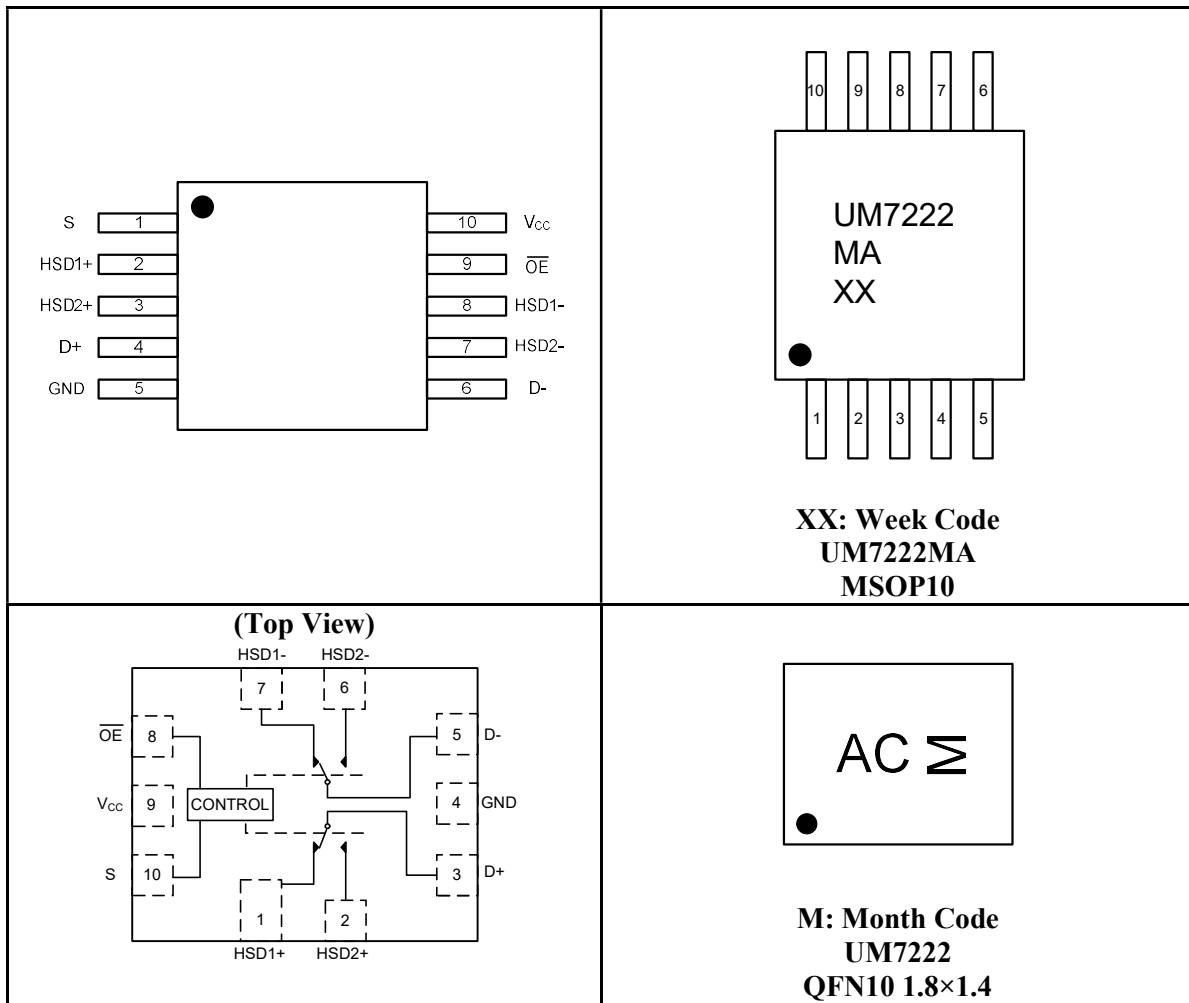

Pin Description

Pin		Name	Function
UM7222MA	UM7222		
2	1	HSD1+	Data Ports
3	2	HSD2+	Data Ports
4	3	D+	Data Ports
5	4	GND	Ground Connection
6	5	D-	Data Ports
7	6	HSD2-	Data Ports
8	7	HSD1-	Data Ports
9	8	\overline{OE}	Output Enable
10	9	V _{CC}	Positive Supply Voltage
1	10	S	Select Input

Ordering Information

Part Number	Packaging Type	Marking Code	Shipping Qty
UM7222MA	MSOP10	UM7222MA	4000pcs/13 Inch Tape & Reel
UM7222	QFN10 1.8×1.4	AC	3000pcs/7 Inch Tape & Reel

Function Table

$\overline{\text{OE}}$	S	HSD1+, HSD1-	HSD2+, HSD2-
1	X	OFF	OFF
0	0	ON	OFF
0	1	OFF	ON

Absolute Maximum Ratings

Symbol	Parameter	Limit	Unit
V_{CC}	Supply Voltage	-0.5 to +6.5	V
V_{IS}	Analog Switch Input Voltage	-0.5 to +6.5	
V_{IN}	Digital Select Input Voltage	-0.5 to +6.5	
I_D	Continuous DC Current	50	mA
P_D	Power Dissipation	0.5	W
T_O	Operating Temperature Range	-40 to +85	°C
T_{STG}	Storage Temperature Range	-65 to +150	

DC Electrical Characteristics

Symbol	Parameter	Test Conditions	V _{CC} (V)	Temp	Limits (-40°C to 85°C)			Unit
					Min	Typ (Note1)	Max	
I _{IN}	Input Leakage Current	0 ≤ V _{IS} ≤ V _{CC}	3.6	Full	-1.0		1.0	μA
I _{OFF}	Power Off Leakage Current	0 ≤ V _{IS} ≤ V _{CC}	0	Full	-1.0		1.0	μA
I _{CC} T	Increase in I _{CC} per Control Voltage	V _{IN} =2.6V	3.6	Full			10	μA
I _{OZ}	OFF State Leakage Current	0 ≤ V _{IS} ≤ V _{CC}	3.6	Full	-1.0		1.0	μA
I _{CC}	Quiescent Supply Current	V _{IS} =V _{CC} or GND	3.6	Full			1.0	μA
V _{IH}	Input High Voltage		3.0 to 3.6	Full	1.3			V
V _{IL}	Input Low Voltage		3.0 to 3.6	Full			0.5	V
V _{IK}	Clamp Diode Voltage	I _S =-18mA	3.0	Full			-1.2	V
R _{ON}	On-Resistance (Note 2)	V _{IS} =0 to 0.4V I _D =8mA	3.0	Full		6.5	9	Ω
ΔR _{ON}	On Resistance Match Between Channels (Note 2, 3)	V _{IS} =0 to 0.4V I _D =8mA	3.0	Full		0.35		Ω
R _{FLAT}	On Resistance Flatness (Note 2, 3)	V _{IS} =0 to 1.0V I _D =8mA	3.0	Full		4.5		Ω

Note 1: Typically values are at V_{CC}=3.3V and T_A=+25°C.

Note 2: Guaranteed by design. Resistance measurements do not include test circuit or package resistance.

Note 3: Parameter is characterized but not tested in production.

AC Electrical Characteristics

Symbol	Parameter	Test Conditions	V _{CC} (V)	Temp	Limits (-40°C to 85°C)			Unit
					Min	Typ (Note1)	Max	
t _{ON}	Turn On Time	V _{IS} =0.8V	3.0 to 3.6	Full		13	30	ns
t _{OFF}	Turn Off Time	V _{IS} =0.8V	3.0 to 3.6	Full		12	25	ns
t _{BBM}	Break Before Make Time (Note 4)	V _{IS} =0.8V	3.0 to 3.6	Full	2	4.7	6.5	ns
t _{PD}	Propagation Delay	C _L =10pF	3.0 to 3.6	Full		0.25		ns
t _{SK(O)}	Channel to Channel Skew	C _L =10pF	3.0 to 3.6			0.05		ns
O _{IRR}	Off Isolation	R _L =50Ω, f=250MHz	3.0 to 3.6	Full		-25		dB
X _{TALK}	Crosstalk	R _L =50Ω, f=250MHz	3.0 to 3.6	Full		-48		dB
BW	-3dB Bandwidth	R _L =50Ω	3.0 to 3.6	Full		550		MHz
Capacitance								
C _{IN}	Control Pin Input Capacitance (Note 5)	V _{CC} =0V				2.5		pF
C _{OFF}	HSD+ HSD- Off Capacitance (Note 5)	V _{CC} =V _{IS} =3.3V, OE=3.3V				4.5		pF
C _{ON}	HSD+ HSD- ON Capacitance (Note 5)	V _{CC} =3.3V, OE=0V				7.0		pF

Note 4: Guaranteed by design.

Note 5: T_A=+25°C, f=1MHz, Capacitance is characterized but not tested in production.

Typical Performance Characteristics

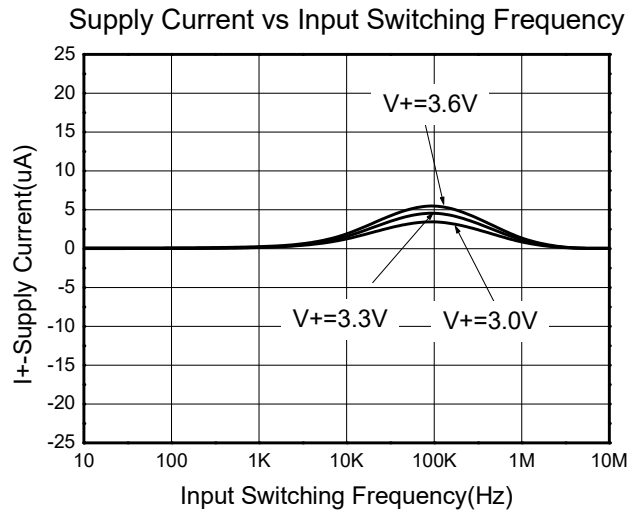
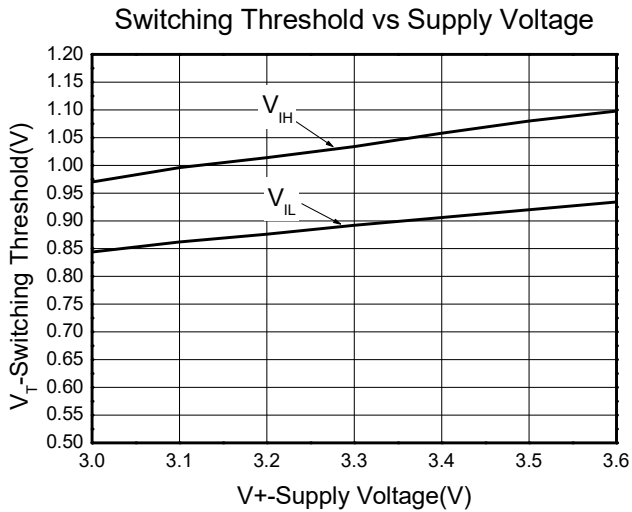
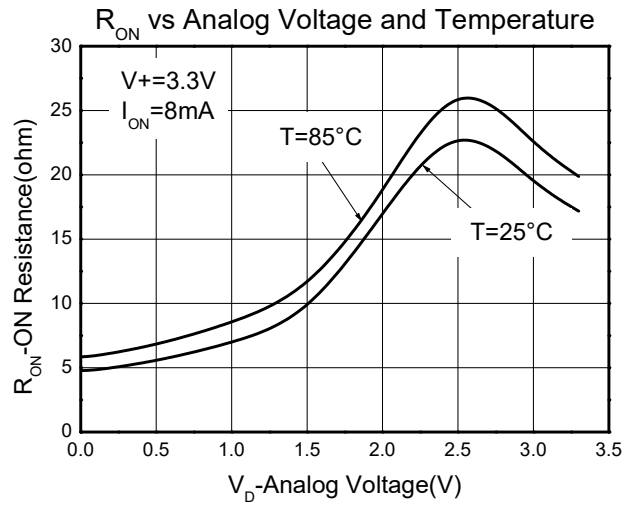
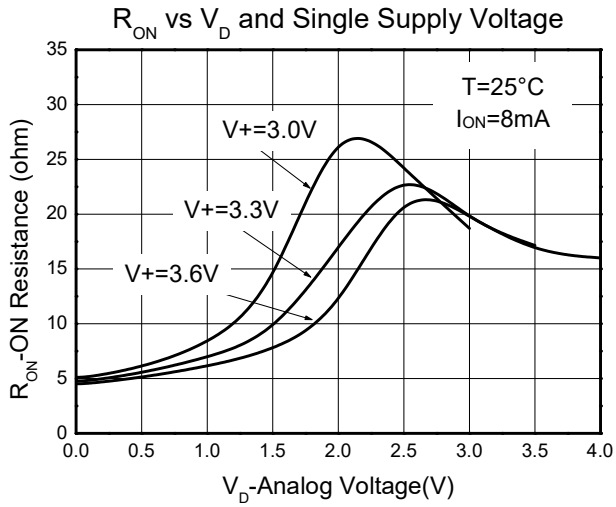

Typical Performance Characteristics (Continued)

Bandwidth

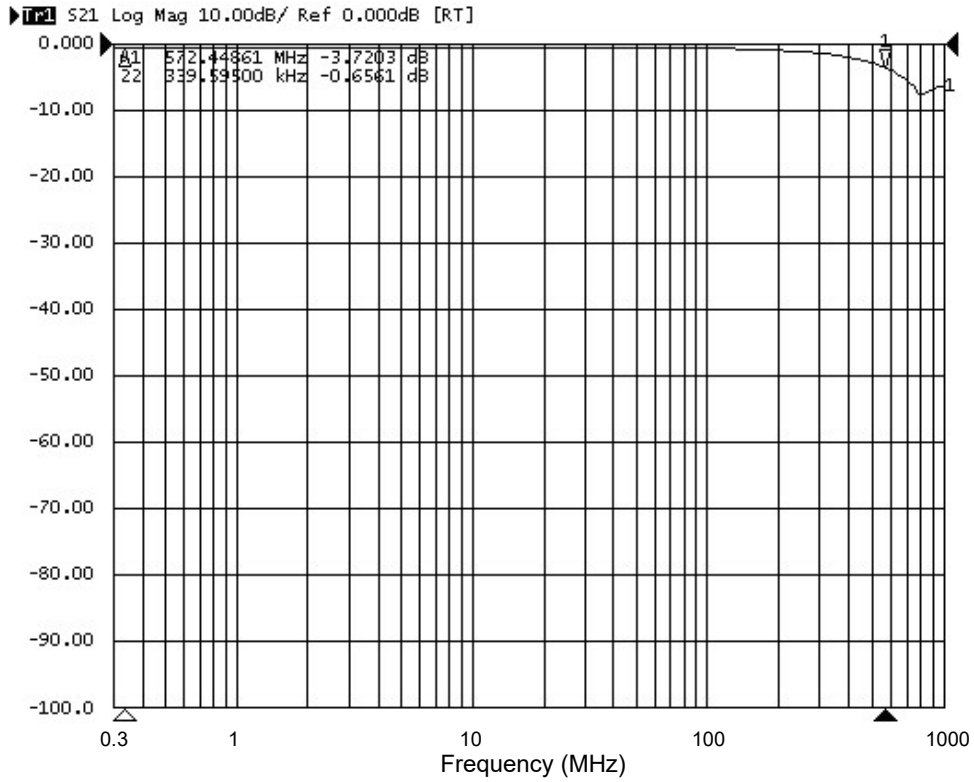

Off Isolation

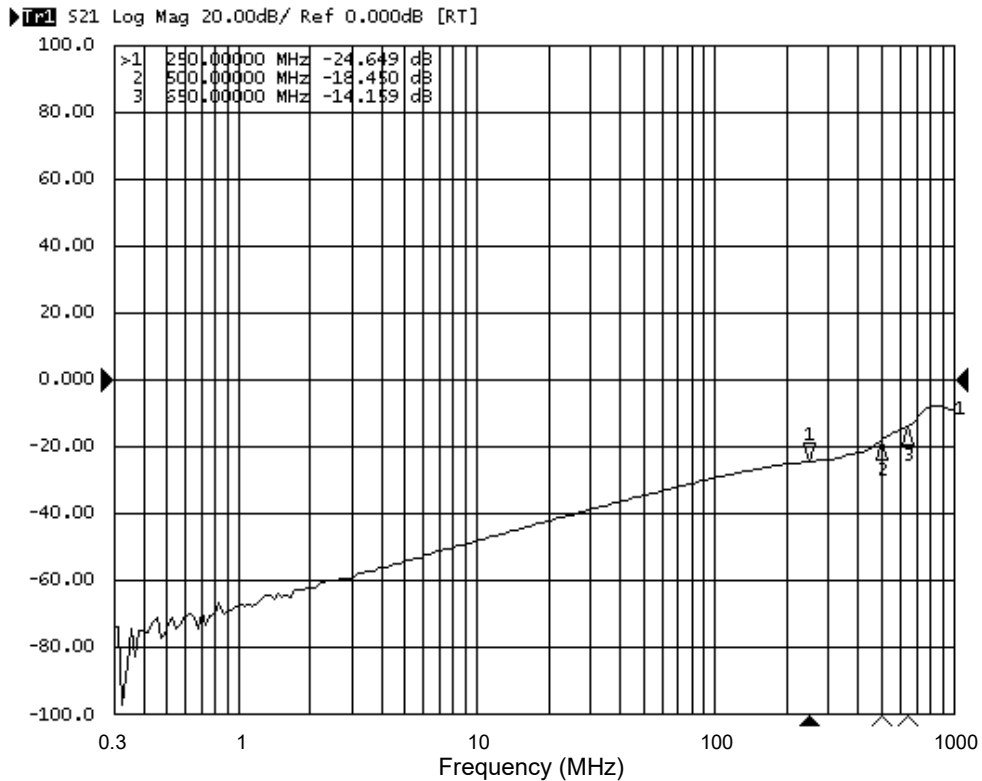

Typical Performance Characteristics (Continued)

Crosstalk

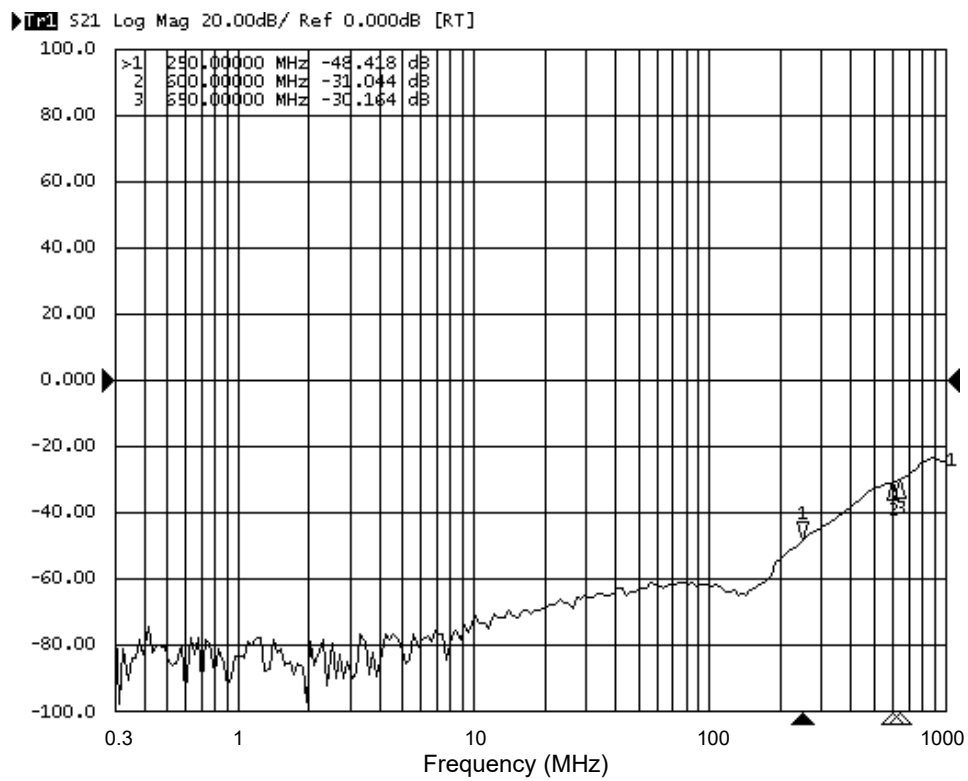

Eye Pattern: 480Mbps USB Signal with No Switch (Through Path)

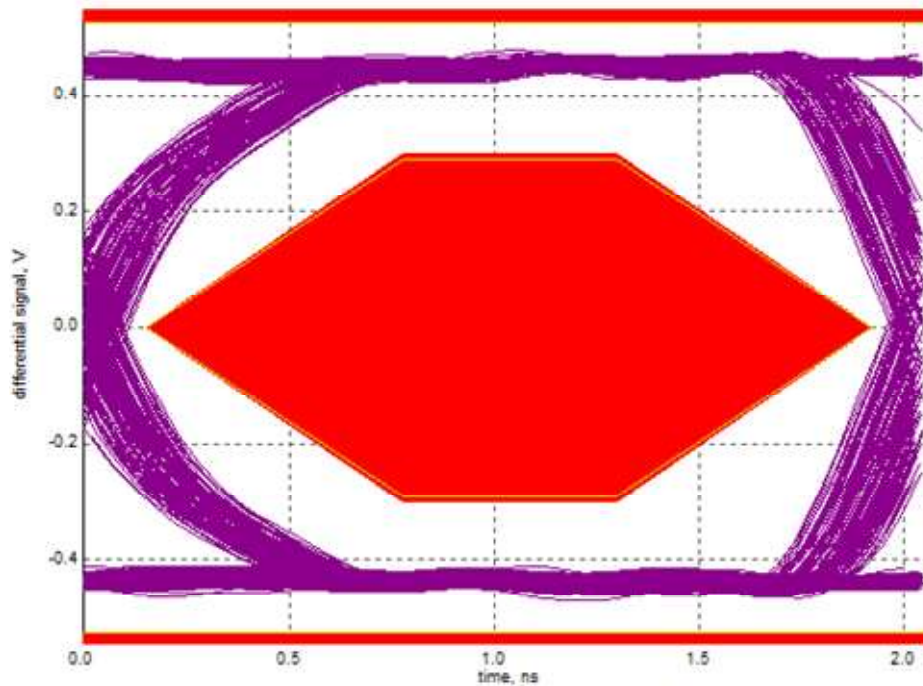

Typical Performance Characteristics (Continued)

Eye Pattern: 480Mbps USB Signal with Switch HSD1+ and HSD1- Path

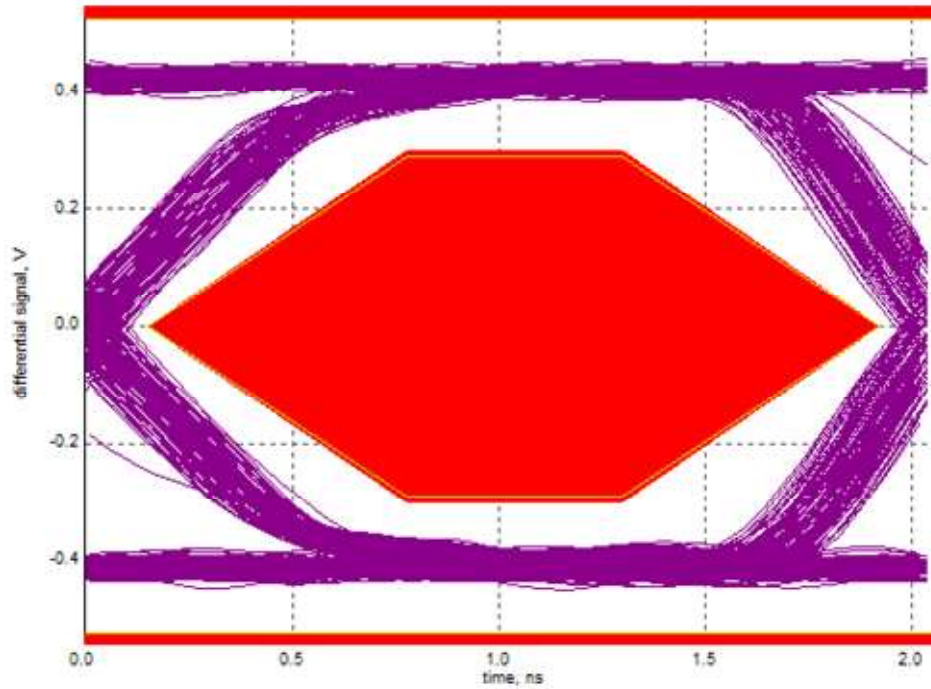

Eye Pattern: 480Mbps USB Signal with Switch HSD2+ and HSD2- Path

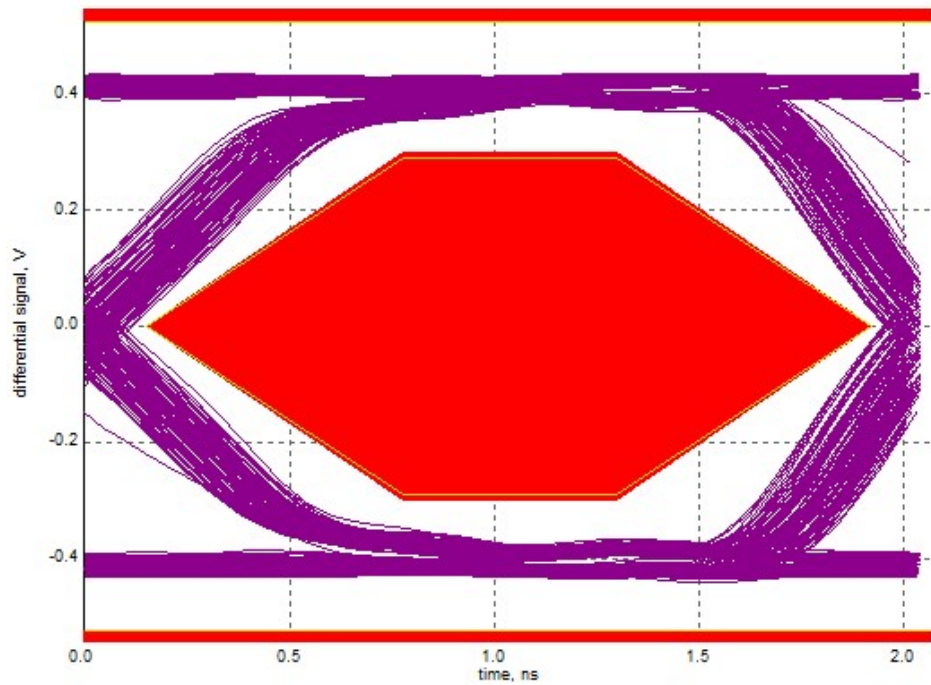

Applications Information

Power-Off Protection

For a VBUS short circuit, the switch is expected to withstand such a condition for at least 24 hours. The UM7222 has specially designed circuitry which prevents unintended signal bleed through as well as guaranteed system reliability during a power-down, over-voltage condition. The protection has been added to the common pins (D+, D-).

Power-On Protection

The USB 2.0 specification also notes that the USB device should be capable of withstanding a VBUS short during transmission of data. This modification works by limiting current flow back into the V+ rail during the over-voltage event so current remains within the safe operating range. In this application, the switch passes the full 5.25V input signal through to the selected output while maintaining specified off isolation on the un-selected pins.

Package Information

UM7222MA MSOP10

Outline Drawing

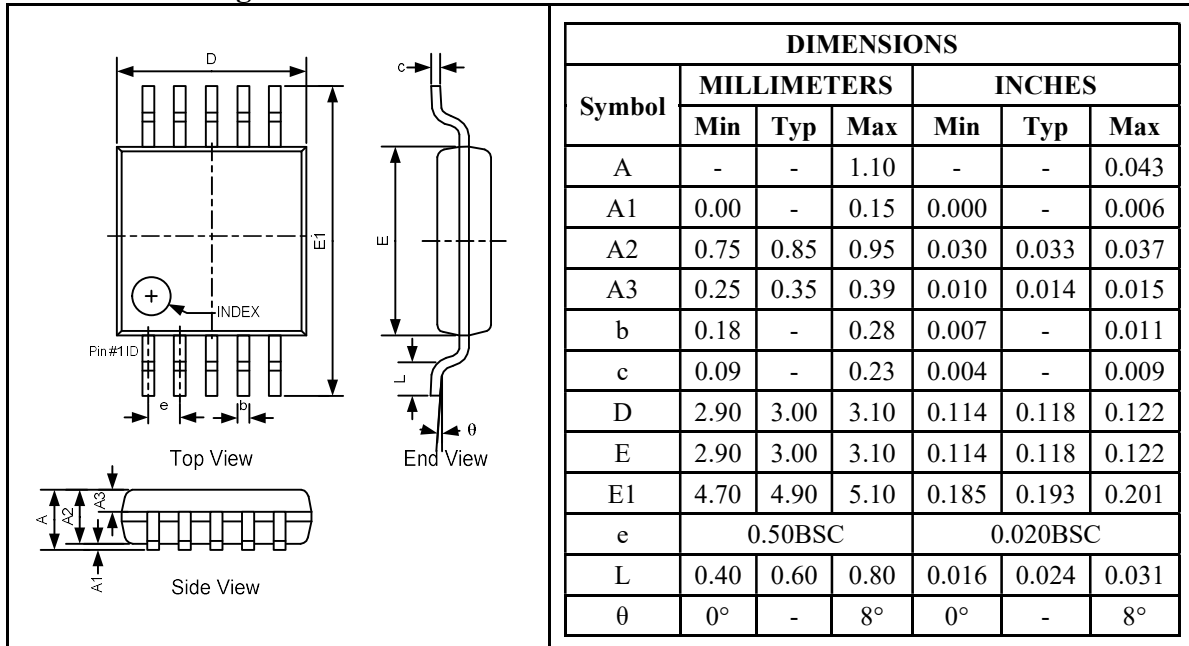

Land Pattern

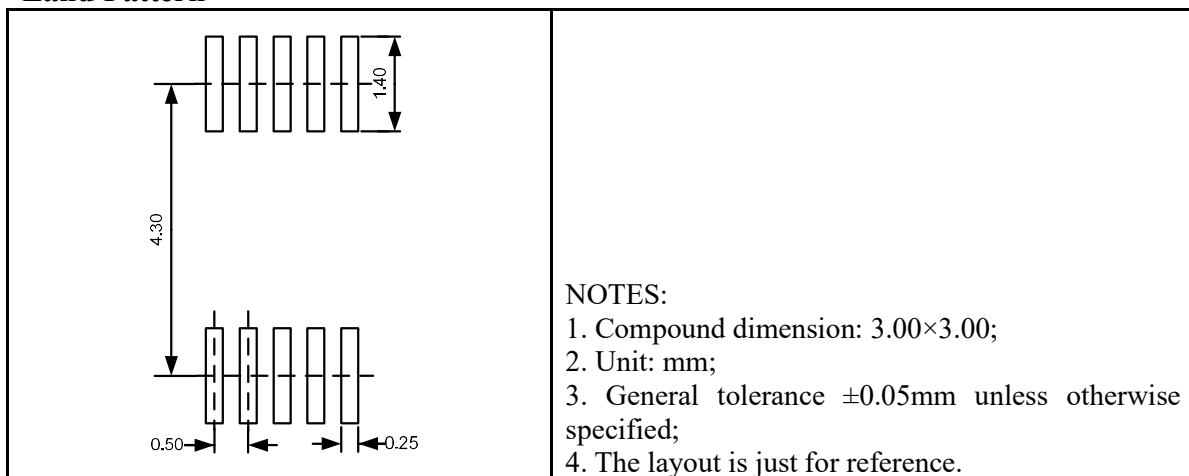

Tape and Reel Orientation



UM7222 QFN10 1.8×1.4

Outline Drawing

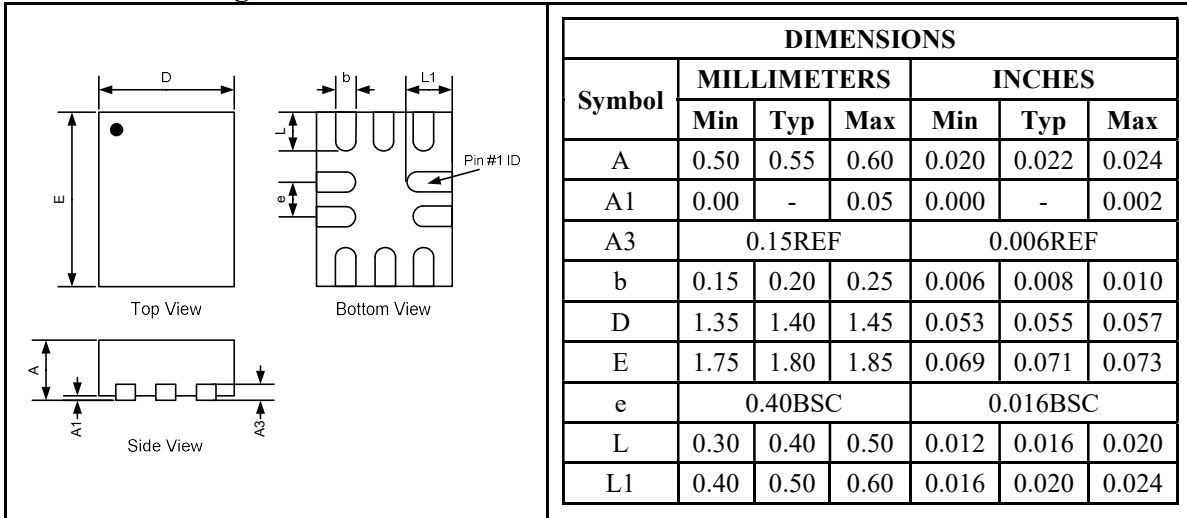

Land Pattern

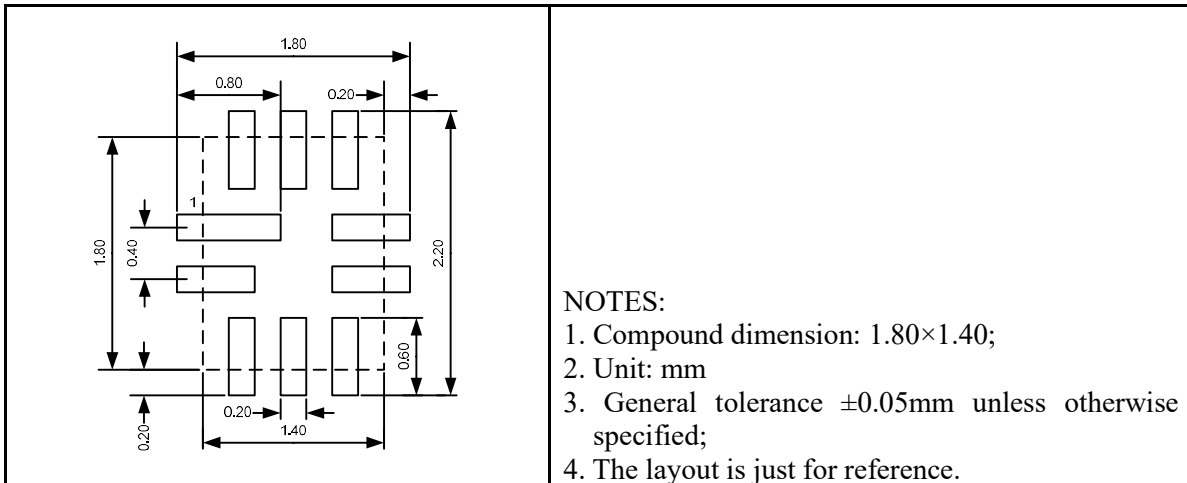

Tape and Reel Orientation

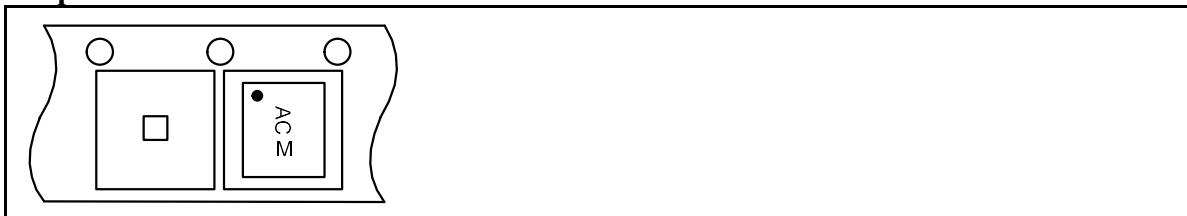

GREEN COMPLIANCE

Union Semiconductor is committed to environmental excellence in all aspects of its operations including meeting or exceeding regulatory requirements with respect to the use of hazardous substances. Numerous successful programs have been implemented to reduce the use of hazardous substances and/or emissions.

All Union components are compliant with the RoHS directive, which helps to support customers in their compliance with environmental directives. For more green compliance information, please visit:

http://www.union-ic.com/index.aspx?cat_code=RoHSDeclaration

IMPORTANT NOTICE

The information in this document has been carefully reviewed and is believed to be accurate. Nonetheless, this document is subject to change without notice. Union assumes no responsibility for any inaccuracies that may be contained in this document, and makes no commitment to update or to keep current the contained information, or to notify a person or organization of any update. Union reserves the right to make changes, at any time, in order to improve reliability, function or design and to attempt to supply the best product possible.



Union Semiconductor, Inc

Add: Unit 606, No.570 Shengxia Road, Shanghai 201210



Tel: 021-51093966

Fax: 021-51026018

Website: www.union-ic.com

Looking for pricing, stock, or lifecycle information?

Click below to explore more details on WIN SOURCE:

-  [View UM7222 on WIN SOURCE](#)
-  [Union Semiconductor Information](#)

Optimize Your Supply Chain with WIN SOURCE Solutions

-  Global Sourcing Solution
-  Obsolete Management
-  Cost Control Management
-  Shortage Management
-  Alternative Solution
-  Excess Inventory Management