

ABF22 THRU ABF 210

SINGLE PHASE 2.0AMP SURFACE MOUNT GLASS PASSIVATED BRIDGE RECTIFIER

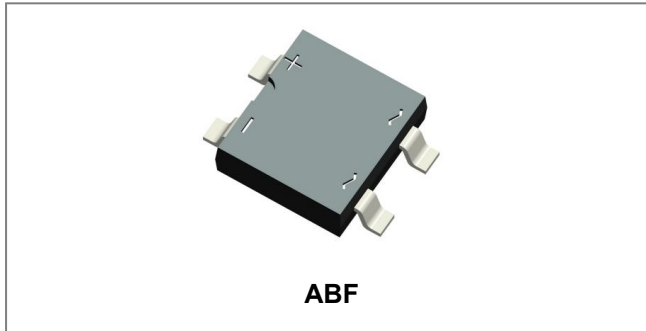

Features

- Glass passivated die construction
- Low forward voltage drop
- High current capability
- High surge current capability
- Designed for surface mount application
- Plastic material-UL flammability 94V-0
- This is a Halogen Free Device
- All SMC parts are traceable to the wafer lot
- Additional testing can be offered upon request

Circuit Diagram

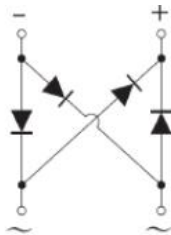

Mechanical Data

- Case: SOPA-4, Molded plastic ABF
- Terminals: Plated leads solderable per MIL-STD-202, Method 208
- Polarity: Polarity symbols marked on case
- Mounting Position: Any

Maximum Ratings@T_A=25°C unless otherwise specified

Single Phase half wave 60Hz, resistive or inductive load. For capacitive load current derate by 20%.

Characteristic	Symbol	ABF22	ABF24	ABF26	ABF28	ABF210	Units
Maximum repetitive peak reverse voltage	V_{RRM}	200	400	600	800	1000	V
RMS Reverse Voltage	$V_{R(RMS)}$	140	280	420	560	700	
Maximum DC blocking voltage	V_{DC}	200	400	600	800	1000	
Average Rectified Output Current @T _C = 100°C	$I_{F(AV)}$	2.0					V
Peak Forward Surge Current 8.3ms Single half sine-wave superimposed on rated load (JEDEC Method)	I_{FSM}	60					A
Rating for fusing (t<8.3ms)	I^2t	15					A ² s

Electrical Characteristics:

Characteristic	Symbol	ABF22	ABF24	ABF26	ABF28	ABF210	Units
Forward voltage per element @ $I_F = 1.0A$ @ $I_F = 2.0A$	V_F			0.95 1.0			V
Maximum DC reverse current at rated DC blocking voltage $T_A = 25^\circ C$ $T_A = 125^\circ C$	I_R			5 200			μA

* Pulse width < 300 μs , duty cycle < 2%

Thermal-Mechanical Specifications:

Characteristic	Symbol	ABF22	ABF24	ABF26	ABF28	ABF210	Units
Typical thermal resistance per leg (Note 1)	$R_{\theta JL}$ $R_{\theta JA}$			62.5 25			$^\circ C/W$
Operating and storage temperature range	T_J, T_{STG}			-55 to +150			$^\circ C$

Note: 1. Thermal resistance form junction to ambient and junction to lead mounted on P.C.B. with 0.2X0.2"(5X5mm) copper pads.

Ratings and Characteristics Curves

FIG. 1 FORWARD CURRENT DERATING CURVE

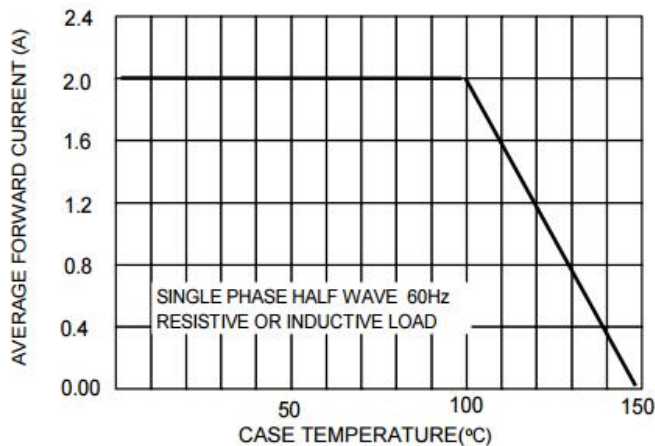

FIG. 2 TYPICAL FORWARD CHARACTERISTIC

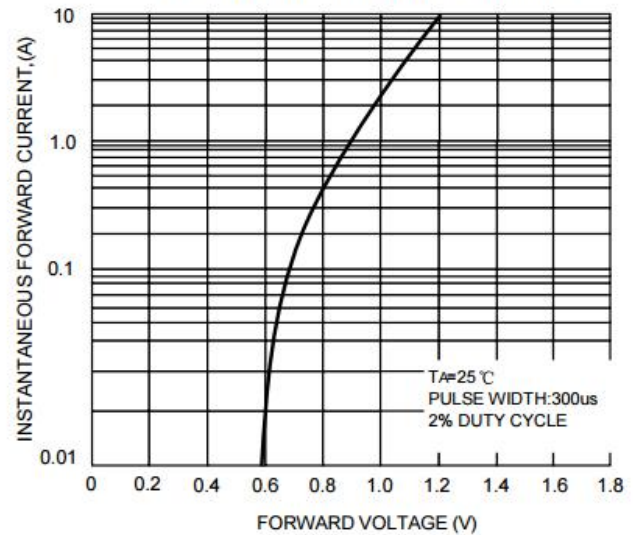
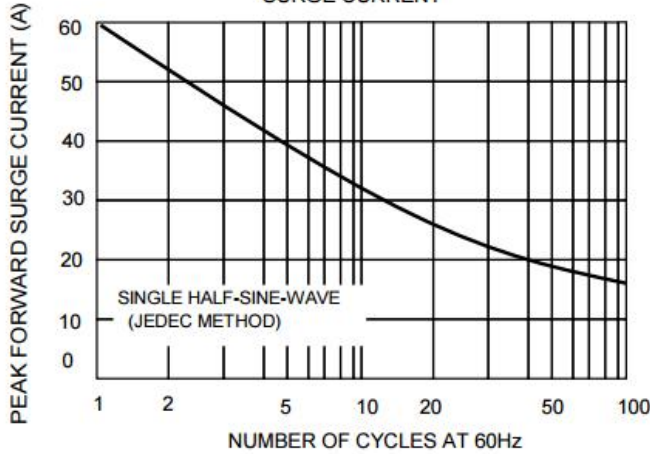

FIG.3 MAXIMUM NON-REPETITIVE SURGE CURRENT



PAD LAYOUT

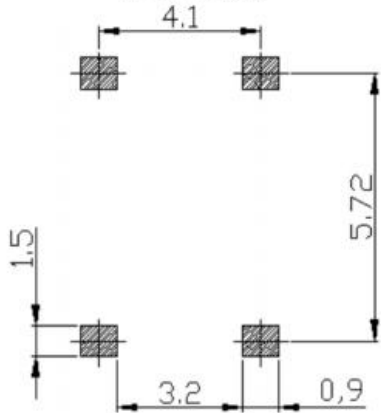
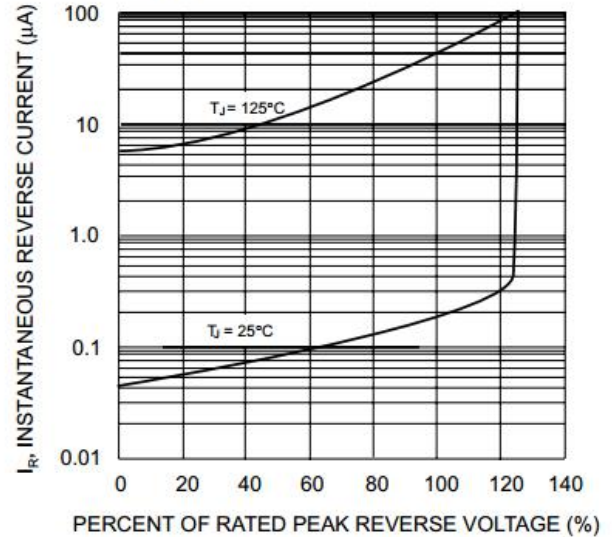

Fig. 4 Typical Reverse Characteristics (per element)



Ordering Information

Device	Package	Plating	Shipping
ABF22 THRU ABF210	ABF	Pure Sn	5000pcs / reel

For information on tape and reel specifications, including part orientation and tape sizes, please refer to our tape and reel packaging specification.

Marking Diagram



Where XXXXX is YYWWL

ABF22 = Type Number
YY = Year
WW = Week
L = Lot Number

Cautions: Molding resin
Epoxy resin UL:94V-0

Mechanical Dimensions ABF(Inches/Millimeters)

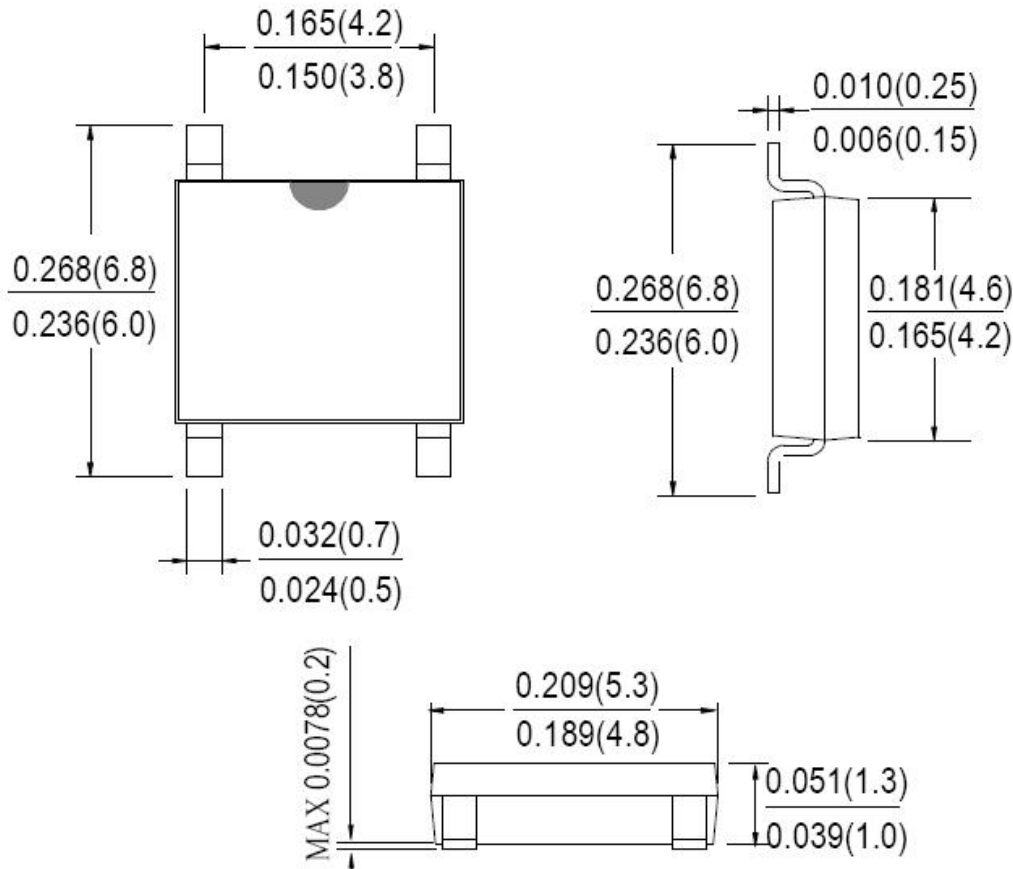

Carrier Tape Specification ABF

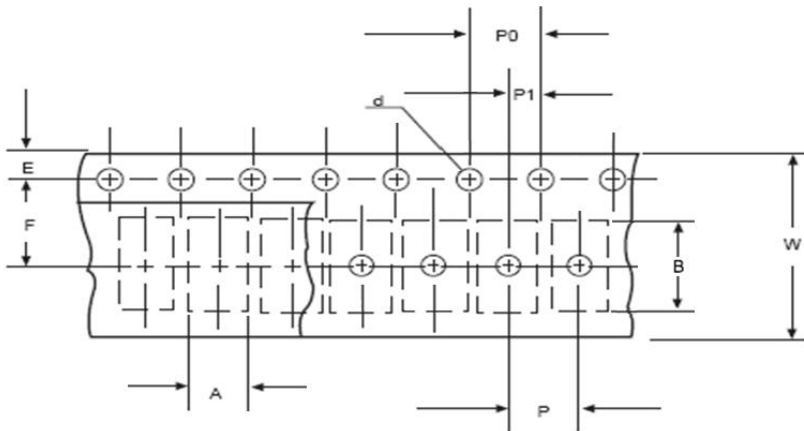

SYMBOL	Millimeters	
	Min.	Max.
A	5.00	5.40
B	6.40	6.80
d	1.40	1.60
E	1.40	1.60
F	5.55	5.75
P	3.90	4.10
P0	3.90	4.10
P1	1.90	2.10
W	11.50	12.50

DISCLAIMER:

1- The information given herein, including the specifications and dimensions, is subject to change without prior notice to improve product characteristics. Before ordering, purchasers are advised to contact the SMC Diode Solutions sales department for the latest version of the datasheet(s).

2- In cases where extremely high reliability is required (such as use in nuclear power control, aerospace and aviation, traffic equipment, medical equipment, and safety equipment), safety should be ensured by using semiconductor devices that feature assured safety or by means of users' fail-safe precautions or other arrangement.

3- In no event shall SMC Diode Solutions be liable for any damages that may result from an accident or any other cause during operation of the user's units according to the datasheet(s). SMC Diode Solution assumes no responsibility for any intellectual property claims or any other problems that may result from applications of information, products or circuits described in the datasheets.

4- In no event shall SMC Diode Solutions be liable for any failure in a semiconductor device or any secondary damage resulting from use at a value exceeding the absolute maximum rating.



5- No license is granted by the datasheet(s) under any patents or other rights of any third party or SMC Diode Solutions.

6- The datasheet(s) may not be reproduced or duplicated, in any form, in whole or part, without the expressed written permission of SMC Diode Solutions.

7- The products (technologies) described in the datasheet(s) are not to be provided to any party whose purpose in their application will hinder maintenance of international peace and safety nor are they to be applied to that purpose by their direct purchasers or any third party. When exporting these products (technologies), the necessary procedures are to be taken in accordance with related laws and regulations..

Looking for pricing, stock, or lifecycle information?

Click below to explore more details on WIN SOURCE:

-  [View ABF210 on WIN SOURCE](#)
-  [SMC Diode Solutions](#) Information

Optimize Your Supply Chain with WIN SOURCE Solutions

-  Global Sourcing Solution
-  Obsolete Management
-  Cost Control Management
-  Shortage Management
-  Alternative Solution
-  Excess Inventory Management