



# THE DATASHEET OF UMB10F



## Ultra Miniature Glass Passivated Single-Phase Surface Mount Flat Bridge Rectifier

### Features

- Low profile space
- Ideal for automated placement
- Glass passivated chip junction
- Low forward voltage drop
- Low leakage current
- High forward surge capability
- High temperature soldering:  
260°C/10 seconds at terminals
- Component in accordance to  
RoHS 2002/95/1 and WEEE 2002/96/EC

SOF2-4



### Mechanical Data

- **Case:** SOF2-4 Molded plastic over glass passivated chip
- **Terminals:** Solder plated, solderable per J-STD-002B and JESD22-B102D
- **Polarity:** Polarity symbols marked on body

### Maximum Ratings & Thermal Characteristics (T<sub>A</sub> = 25 °C unless otherwise noted)

Items	Symbol	UMB 05F	UMB 1F	UMB 2F	UMB 4F	UMB 6F	UMB 8F	UMB 10F	UNIT
Maximum repetitive peak reverse voltage	V <sub>RRM</sub>	50	100	200	400	600	800	1000	V
Maximum RMS voltage	V <sub>RMS</sub>	35	70	140	280	420	560	700	V
Maximum DC blocking voltage	V <sub>DC</sub>	50	100	200	400	600	800	1000	V
Maximum average forward rectified current at T <sub>A</sub> =30°C -on glass-epoxy P.C.B. <sup>(1)</sup> -on aluminum substrate <sup>(2)</sup>	I <sub>F(AV)</sub>	0.5 0.8							A
Peak forward surge current 8.3 ms single half sine-wave superimposed on rated load (JEDEC Method)	I <sub>FSM</sub>	20							A
Typical Current Squared Time	I <sup>2</sup> t	1.66							A <sup>2</sup> S
Thermal resistance from junction to ambient per leg	R <sub>θJA</sub> <sup>(1)</sup> R <sub>θJA</sub> <sup>(2)</sup>	100 80							°C/W
Thermal resistance from junction to lead per leg <sup>(1)</sup>	R <sub>θJL</sub>	30							°C/W
Operating junction and storage temperature range	T <sub>J</sub> , T <sub>STG</sub>	-55 to +150							°C

Note 1: On glass epoxy P.C.B. mounted on 0.06×0.04" (1.5×1.1mm) pads

Note 2: On aluminum substrate P.C.B. with an area of 0.8×0.8" (20×20mm) mounted on 0.06×0.04" (1.5×1.1mm) solder pad

### Electrical Characteristics (T<sub>A</sub> = 25 °C unless otherwise noted)

Items	Symbol	Min	Type	Max	UNIT
Instantaneous forward voltage per leg I <sub>F</sub> =0.4A	V <sub>F</sub>	-	0.96	1.10	V
Reverse current per leg V <sub>R</sub> =V <sub>DC</sub>	I <sub>R</sub>	-	-	5 100	uA
Reverse Recovery Time (Note 2)	T <sub>rr</sub>	-	2	-	uSec

Notes: 1.Pulse test :300 us pulse width,1% duty cycle.

2.Test Conditions: I<sub>F</sub>= 0.5A, I<sub>R</sub>= -1.0A, I<sub>RR</sub>= -0.25A.

# RATING AND CHARACTERISTICS CURVES (UMB05F THRU UMB10F)

**Fig.1 Forward Current Derating Curve**

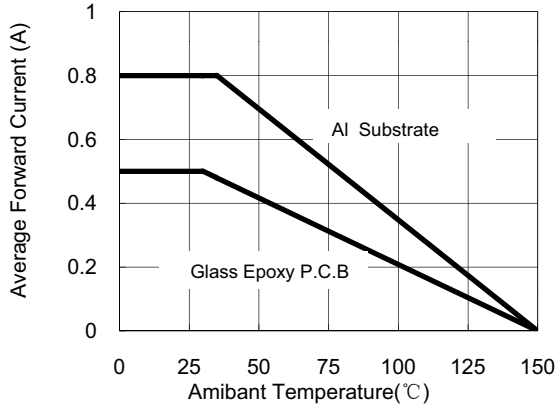

**Fig.2 Maximum Non-Repetitive Peak Forward Surge Current**

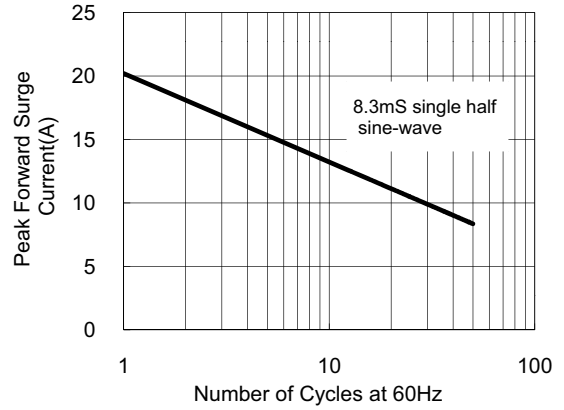

**Fig.3 Typical Instantaneous Forward Characteristics**

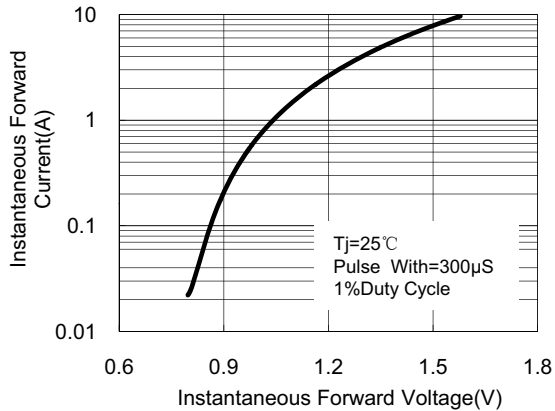

**Fig.4 Typical Reverse Leakage Characteristics**

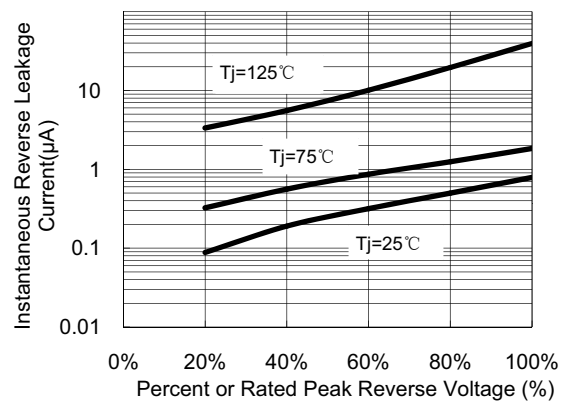

# PACKAGE OUTLINE

Plastic surface mounted package; 4 leads

SOF2-4

unit: mm

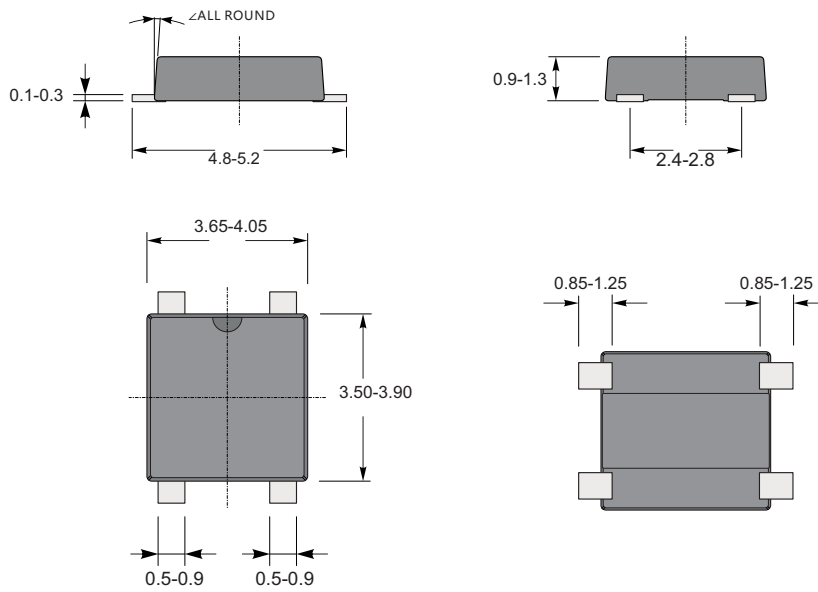

## The recommended mounting pad size

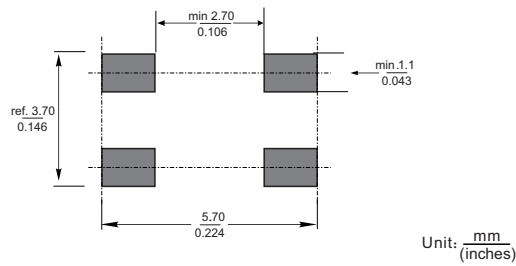

## Marking



Type number	Marking code
UMB05F	B1
UMB1F	B2
UMB2F	B3
UMB4F	B4
UMB6F	B5
UMB8F	B6
UMB10F	B7

# PACKAGING OF DIODE AND BRIDGE RECTIFIERS



## REEL PACK

PACKAGE	PACKING CODE	EA PER REEL	EA PER INNER BOX	COMPONENT SPACE (mm)	TAPE SPACE (mm)	REEL DIA (mm)	CARTON SIZE (mm)	EA PER CARTON	GROSS WEIGHT(Kg)
SOF2-4	-T	4,000	8,000	---	---	---	360*355*360	96,000	15



## Looking for pricing, stock, or lifecycle information?

Click below to explore more details on WIN SOURCE:

-  [View UMB10F on WIN SOURCE](#)
-  [Rectron USA Information](#)

## Optimize Your Supply Chain with WIN SOURCE Solutions

-  Global Sourcing Solution
-  Obsolete Management
-  Cost Control Management
-  Shortage Management
-  Alternative Solution
-  Excess Inventory Management