



# THE DATASHEET OF HMC476MP86TR





## SiGe HBT GAIN BLOCK MMIC AMPLIFIER, DC - 6 GHz

### Typical Applications

The HMC476MP86 / HMC476MP86E is an ideal RF/IF gain block & LO or PA driver for:

- Cellular / PCS / 3G
- Fixed Wireless & WLAN
- CATV, Cable Modem & DBS
- Microwave Radio & Test Equipment

### Features

- P1dB Output Power: +12 dBm
- Gain: 20 dB
- Output IP3: +25 dBm
- Cascadable 50 Ohm I/Os
- Single Supply: +5V to +12V
- Included in the HMC-DK001 Designer's Kit

### Functional Diagram

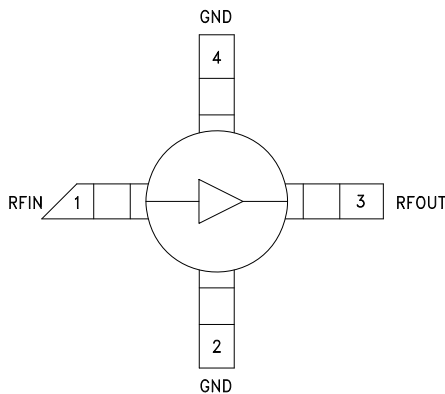

### General Description

The HMC476MP86 & HMC476MP86E are SiGe Heterojunction Bipolar Transistor (HBT) Gain Block MMIC SMT amplifiers covering DC to 6 GHz. This Micro-P packaged amplifier can be used as a cascadable 50 Ohm RF/IF gain stage as well as a LO or PA driver with up to +13 dBm output power. The HMC476MP86 & HMC476MP86E offers 20 dB of gain with a +25 dBm output IP3 at 850 MHz while requiring only 35 mA from a single positive supply. The Darlington feedback pair used results in reduced sensitivity to normal process variations and excellent gain stability over temperature while requiring a minimal number of external bias components.

### Electrical Specifications, $V_s = 5V$ , $R_{bias} = 56 \text{ Ohm}$ , $T_A = +25^\circ \text{ C}$

| Parameter   |               | Min. | Typ.  | Max.  | Units  |
|---|---------------|------|-------|-------|--------|
| Gain  | DC - 1.0 GHz  | 18.5 | 20.0  |       | dB     |
|   | 1.0 - 2.0 GHz | 15.5 | 17.0  |       | dB     |
|   | 2.0 - 3.0 GHz | 13.5 | 15.0  |       | dB     |
|   | 3.0 - 4.0 GHz | 11.5 | 13.0  |       | dB     |
|   | 4.0 - 6.0 GHz | 9.0  | 10.5  |       | dB     |
| Gain Variation Over Temperature   | DC - 6 GHz    |      | 0.008 | 0.012 | dB/ °C |
| Input Return Loss   | DC - 1.0 GHz  |      | 20    |       | dB     |
|   | 1.0 - 6.0 GHz |      | 15    |       | dB     |
| Output Return Loss  | DC - 4.5 GHz  |      | 20    |       | dB     |
|   | 4.5 - 6.0 GHz |      | 13    |       | dB     |
| Reverse Isolation   | DC - 6 GHz    |      | 18    |       | dB     |
| Output Power for 1 dB Compression (P1dB)                                    | 0.5 - 5.0 GHz | 9.0  | 12.0  |       | dBm    |
|   | 5.0 - 6.0 GHz | 8.0  | 11.0  |       | dBm    |
| Output Third Order Intercept (IP3)<br>(Pout= 0 dBm per tone, 1 MHz spacing) | DC - 5 GHz    |      | 25    |       | dBm    |
|   | 5.0 - 6.0 GHz |      | 23    |       | dBm    |
| Noise Figure  | DC - 3.0 GHz  |      | 2.5   |       | dB     |
|   | 3.0 - 6.0 GHz |      | 3.5   |       | dB     |
| Supply Current (Icq)  |               |      | 35    |       | mA     |

Note: Data taken with broadband bias tee on device output.

Information furnished by Analog Devices is believed to be accurate and reliable. However, no responsibility is assumed by Analog Devices for its use, nor for any infringements of patents or other rights of third parties that may result from its use. Specifications subject to change without notice. No license is granted by implication or otherwise under any patent or patent rights of Analog Devices. Trademarks and registered trademarks are the property of their respective owners.

For price, delivery, and to place orders: Analog Devices, Inc., One Technology Way, P.O. Box 9106, Norwood, MA 02062-9106  
Phone: 781-329-4700 • Order online at [www.analog.com](http://www.analog.com)  
Application Support: Phone: 1-800-ANALOG-D



**SiGe HBT GAIN BLOCK  
MMIC AMPLIFIER, DC - 6 GHz**

**Broadband Gain & Return Loss**

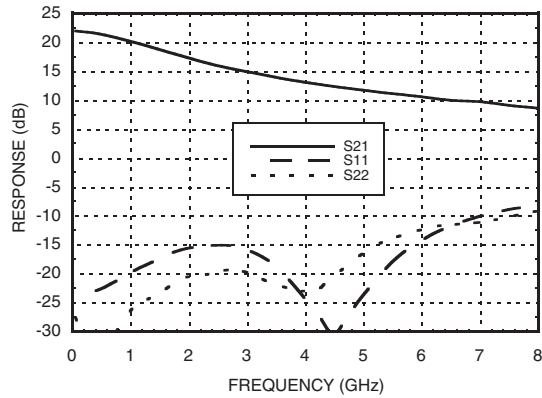

**Gain vs. Temperature**

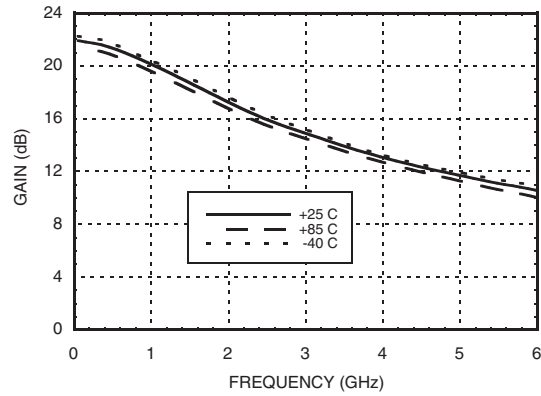

**Input Return Loss vs. Temperature**

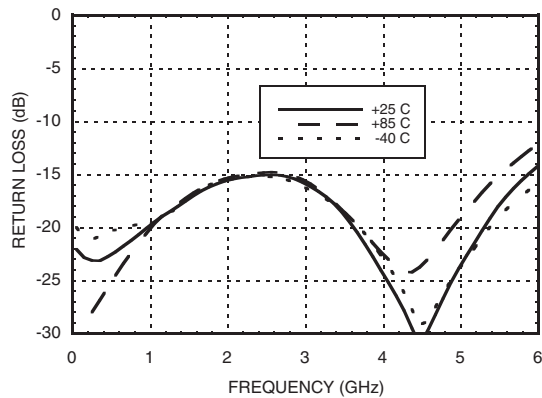

**Output Return Loss vs. Temperature**

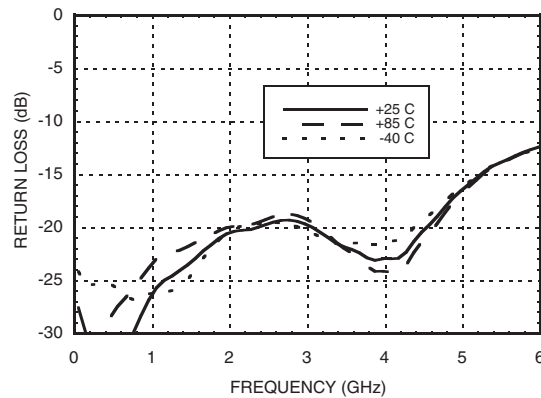

**Reverse Isolation vs. Temperature**

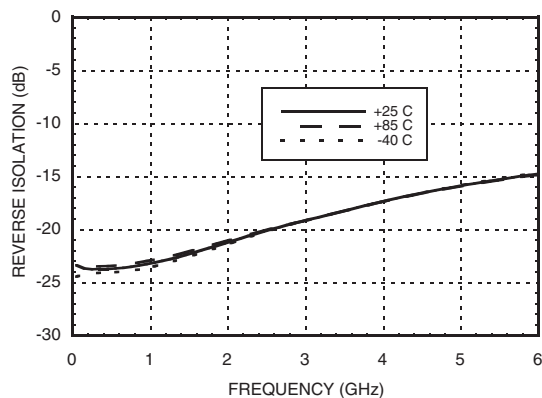

**Noise Figure vs. Temperature**

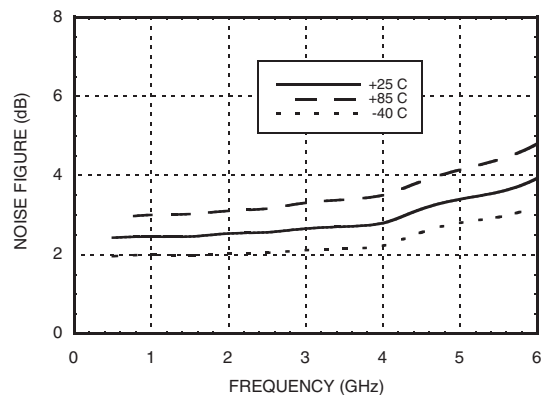



**SiGe HBT GAIN BLOCK  
MMIC AMPLIFIER, DC - 6 GHz**

8

AMPLIFIERS - DRIVER & GAIN BLOCK - SMT

**P1dB vs. Temperature**

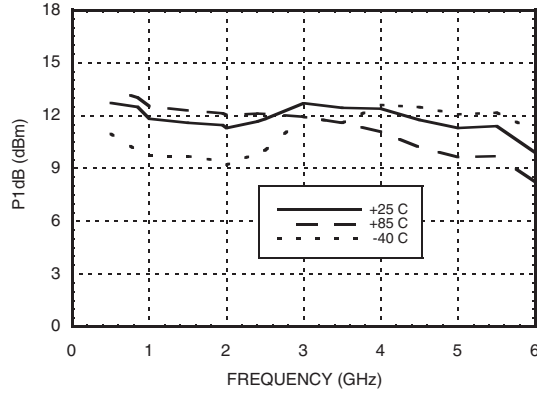

**Psat vs. Temperature**

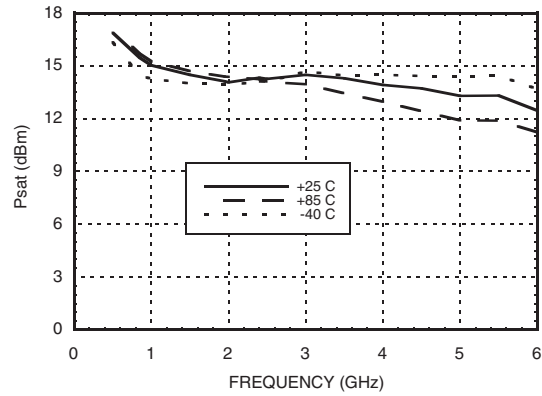

**Output IP3 vs. Temperature**

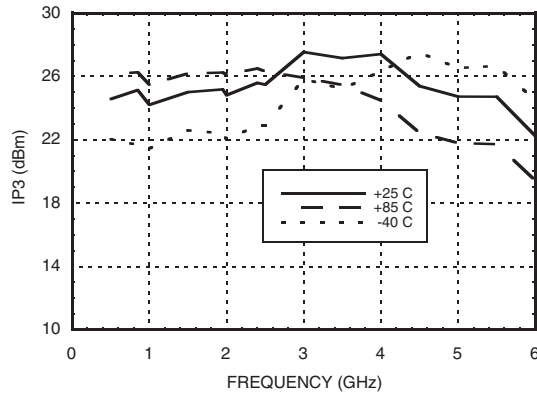

**Gain, Power & OIP3 vs. Supply Voltage for Constant Id= 35 mA @ 850 MHz**

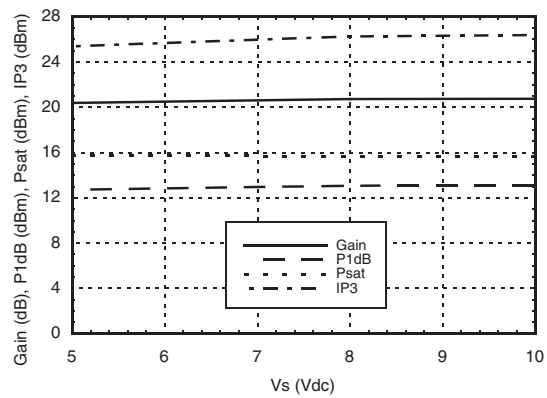

**Vcc vs. Icc Over Temperature for Fixed Vs= 5V, RBIAS= 56 Ohms**

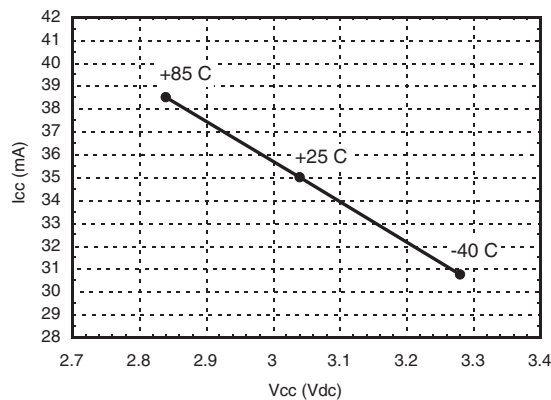

Information furnished by Analog Devices is believed to be accurate and reliable. However, no responsibility is assumed by Analog Devices for its use, nor for any infringements of patents or other rights of third parties that may result from its use. Specifications subject to change without notice. No license is granted by implication or otherwise under any patent or patent rights of Analog Devices. Trademarks and registered trademarks are the property of their respective owners.

For price, delivery, and to place orders: Analog Devices, Inc., One Technology Way, P.O. Box 9106, Norwood, MA 02062-9106 Phone: 781-329-4700 • Order online at [www.analog.com](http://www.analog.com) Application Support: Phone: 1-800-ANALOG-D



## SiGe HBT GAIN BLOCK MMIC AMPLIFIER, DC - 6 GHz

### Absolute Maximum Ratings

|   |                |
|---|----------------|
| Collector Bias Voltage (Vcc)                                    | +6.0 Vdc       |
| Collector Bias Current (Icc)                                    | 45 mA          |
| RF Input Power (RFIN)(Vcc = +3.0 Vdc)                           | +5 dBm         |
| Junction Temperature  | 150 °C         |
| Continuous Pdiss (T = 85 °C)<br>(derate 7.75 mW/°C above 85 °C) | 0.504 W        |
| Thermal Resistance<br>(junction to lead)                        | 129 °C/W       |
| Storage Temperature   | -65 to +150 °C |
| Operating Temperature   | -40 to +85 °C  |



ELECTROSTATIC SENSITIVE DEVICE  
OBSERVE HANDLING PRECAUTIONS

### Outline Drawing

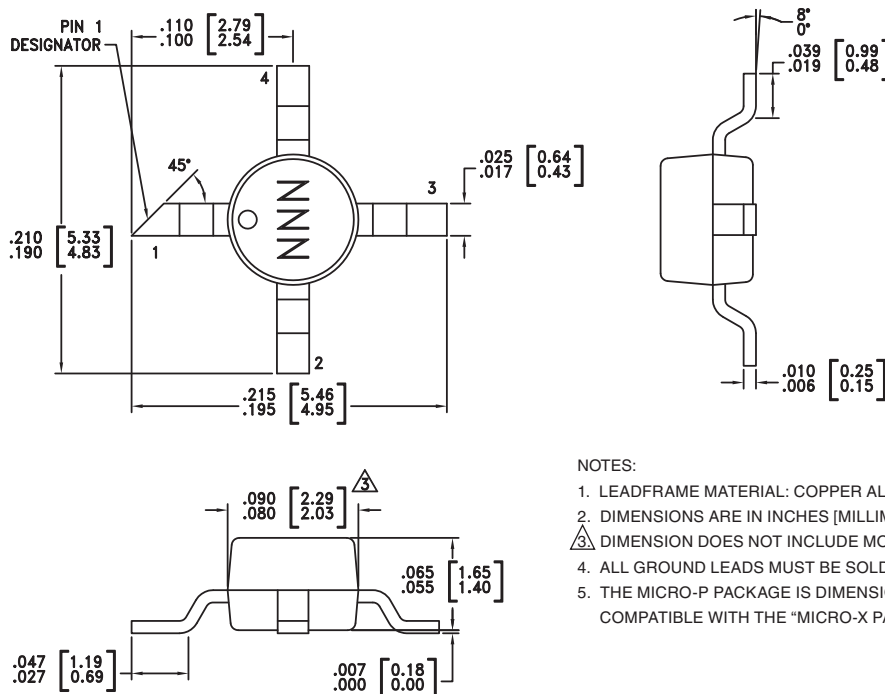

#### NOTES:

- LEADFRAME MATERIAL: COPPER ALLOY
- DIMENSIONS ARE IN INCHES [MILLIMETERS]
- DIMENSION DOES NOT INCLUDE MOLDFLASH OF 0.15mm PER SIDE.
- ALL GROUND LEADS MUST BE SOLDERED TO PCB RF GROUND.
- THE MICRO-P PACKAGE IS DIMENSIONALLY COMPATIBLE WITH THE "MICRO-X PACKAGE"

### Package Information

| Part Number | Package Body Material                              | Lead Finish   | MSL Rating          | Package Marking |
|-------------|--|---------------|---------------------|-----------------|
| HMC476MP86  | Low Stress Injection Molded Plastic                | Sn/Pb Solder  | MSL1 <sup>[1]</sup> | 476             |
| HMC476MP86E | RoHS-compliant Low Stress Injection Molded Plastic | 100% matte Sn | MSL1 <sup>[2]</sup> | 476             |

[1] Max peak reflow temperature of 235 °C

[2] Max peak reflow temperature of 260 °C



### Pin Descriptions

| Pin Number | Function | Description   | Interface Schematic |
|------------|----------|---|---------------------|
| 1          | RFIN     | This pin is DC coupled.<br>An off chip DC blocking capacitor is required. |                     |
| 3          | RFOUT    | RF output and DC Bias (Vcc) for the output stage.                         |                     |
| 2, 4       | GND      | These pins must be connected to RF/DC ground.                             |                     |

### Application Circuit

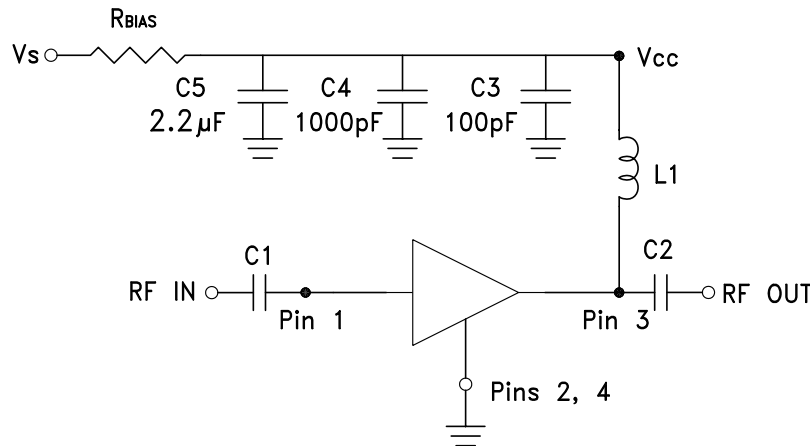

### Recommended Bias Resistor Values for $I_{cc} = 35 \text{ mA}$ , $R_{bias} = (V_s - V_{cc}) / I_{cc}$

| Supply Voltage (Vs) | 5V    | 8V    | 10V   | 12V   |
|---------------------|-------|-------|-------|-------|
| RBIAS VALUE         | 56 Ω  | 130 Ω | 180 Ω | 240 Ω |
| RBIAS POWER RATING  | 1/8 W | 1/4 W | 1/4 W | 1/2 W |

**Note:**

- External blocking capacitors are required on RFIN and RFOUT.
- RBIAS provides DC bias stability over temperature.

### Recommended Component Values for Key Application Frequencies

| Component | Frequency (MHz) |        |        |        |        |        |        |        |
|-----------|-----------------|--------|--------|--------|--------|--------|--------|--------|
|           | 50              | 900    | 1900   | 2200   | 2400   | 3500   | 5200   | 5800   |
| L1        | 270 nH          | 56 nH  | 18 nH  | 18 nH  | 15 nH  | 8.2 nH | 6.8 nH | 3.3 nH |
| C1, C2    | 0.01 μF         | 100 pF | 100 pF | 100 pF | 100 pF | 100 pF | 100 pF | 100 pF |

Information furnished by Analog Devices is believed to be accurate and reliable. However, no responsibility is assumed by Analog Devices for its use, nor for any infringements of patents or other rights of third parties that may result from its use. Specifications subject to change without notice. No license is granted by implication or otherwise under any patent or patent rights of Analog Devices. Trademarks and registered trademarks are the property of their respective owners.

For price, delivery, and to place orders: Analog Devices, Inc., One Technology Way, P.O. Box 9106, Norwood, MA 02062-9106  
Phone: 781-329-4700 • Order online at [www.analog.com](http://www.analog.com)  
Application Support: Phone: 1-800-ANALOG-D



### Evaluation PCB

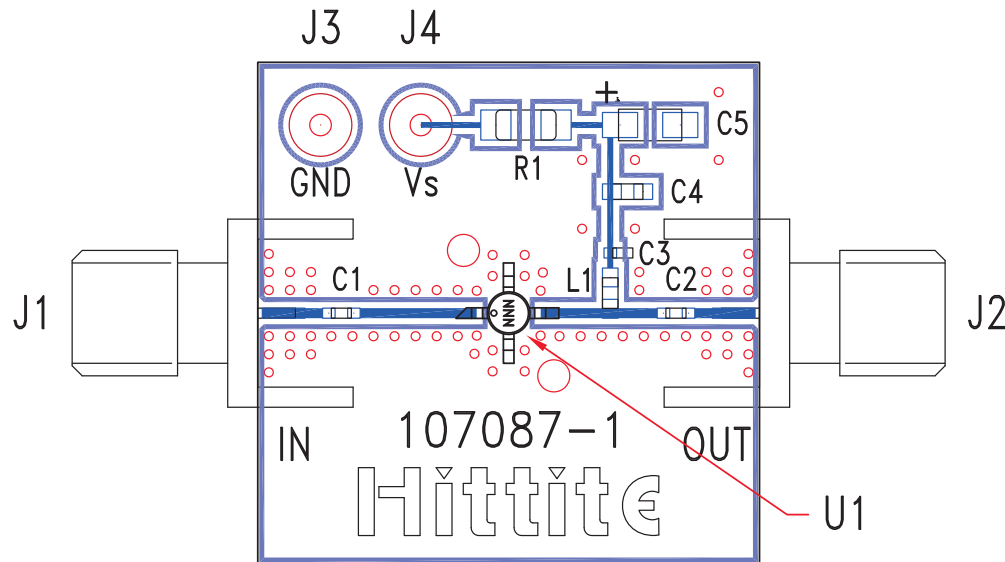

### List of Materials for Evaluation PCB 107487 [1]

| Item    | Description                     |
|---------|---------------------------------|
| J1 - J2 | PCB Mount SMA Connector         |
| J3 - J4 | DC Pin                          |
| C1, C2  | Capacitor, 0402 Pkg.            |
| C3      | 100 pF Capacitor, 0402 Pkg.     |
| C4      | 1000 pF Capacitor, 0603 Pkg.    |
| C5      | 2.2 $\mu$ F Capacitor, Tantalum |
| R1      | Resistor, 1210 Pkg.             |
| L1      | Inductor, 0603 Pkg.             |
| U1      | HMC476MP86 / HMC476MP86E        |
| PCB [2] | 107087 Evaluation PCB           |

[1] Reference this number when ordering complete evaluation PCB

[2] Circuit Board Material: Rogers 4350

The circuit board used in the application should use RF circuit design techniques. Signal lines should have 50 Ohm impedance while the package ground leads should be connected directly to the ground plane similar to that shown. A sufficient number of via holes should be used to connect the top and bottom ground planes. The evaluation board should be mounted to an appropriate heat sink. The evaluation circuit board shown is available from Hittite upon request.

## Looking for pricing, stock, or lifecycle information?

Click below to explore more details on WIN SOURCE:

 [View HMC476MP86TR on WIN SOURCE](#)

 [Analog Devices Inc. Information](#)

## Optimize Your Supply Chain with WIN SOURCE Solutions

-  Global Sourcing Solution
-  Obsolete Management
-  Cost Control Management
-  Shortage Management
-  Alternative Solution
-  Excess Inventory Management