



**THE DATASHEET OF
ACS37002LMABTR-050B5**



400 kHz, High Accuracy Current Sensor with Pin-Selectable Gains and Adjustable Overcurrent Fast Fault in SOICW-16 Package

FEATURES AND BENEFITS

- High operating bandwidth for fast control loops or where high-speed currents are monitored
 - 400 kHz bandwidth
 - 1.1 μ s typical response time
- High accuracy
 - $\pm 1\%$ maximum sensitivity error over temperature (K series)
 - ± 8 mV maximum offset voltage over temperature
 - Non-ratiometric operation with V_{REF} output
 - Low noise LA package
 - ◇ 160 mV_{RMS} for 3.3 V supply
 - ◇ 124 mV_{RMS} for 5 V supply
 - Differential sensing for high immunity to external magnetic fields
 - No magnetic hysteresis
- Adjustable fast overcurrent fault
 - 1 μ s typical response time
 - Pin adjustable threshold
- Externally configurable gain settings using two logic pins
 - Four adjustable gain levels for increased design flexibility

Continued on the next page...

PACKAGE: 16-Pin SOICW (suffix MA/LA)

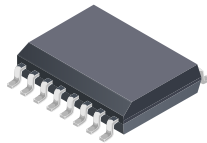

Not to scale

DESCRIPTION

The ACS37002 is a fully integrated Hall-effect current sensor in an SOICW-16 package that is factory-trimmed to provide high accuracy over the entire operating range without the need for customer programming. The current is sensed differentially by two Hall plates that subtract out interfering external common-mode magnetic fields.

The package construction provides high isolation by magnetically coupling the field generated by the current in the conductor to the monolithic Hall sensor IC which has no physical connection to the integrated current conductor. The MA package is optimized for higher isolation with dielectric withstand voltage, 3125 V_{RMS} , and 0.85 $m\Omega$ conductor resistance. The LA package is optimized for lower noise with 2250 V_{RMS} dielectric withstand voltage and 1 $m\Omega$ conductor resistance.

The ACS37002 has functional features that are externally configurable and robust without the need for programming. Two logic gain selection pins can be used to configure the device to one of four defined sensitivities and corresponding current ranges. A fast overcurrent fault output provides short-circuit detection for system protection with a fault threshold that is proportional to the current range and can be set with an analog input. The reference pin provides a stable voltage that corresponds to the 0 A output voltage. This reference voltage allows for differential measurements as well as a device-referred voltage to set the overcurrent fault threshold.

Devices are RoHS compliant and lead (Pb) free with 100% matte-tin-plated leadframes.

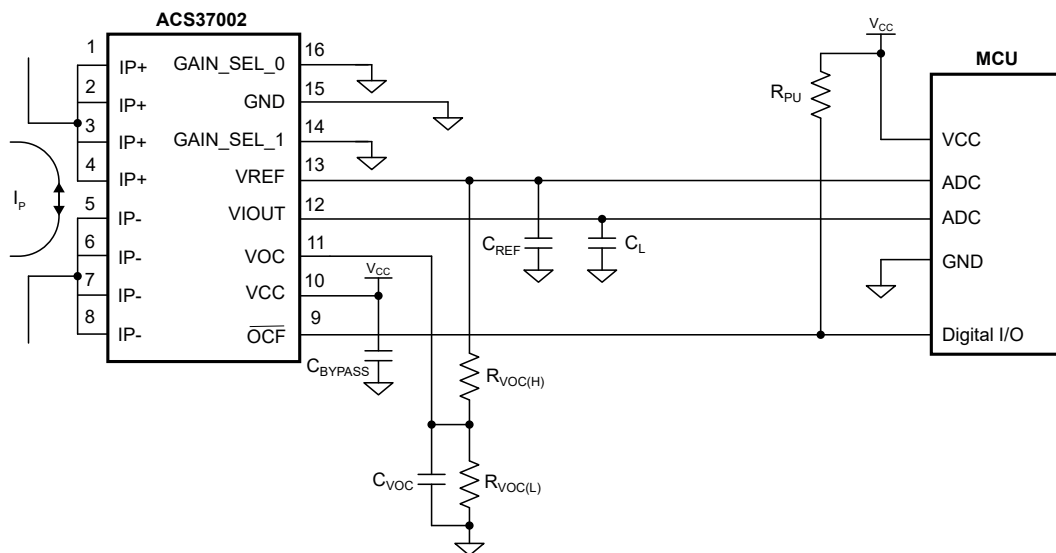
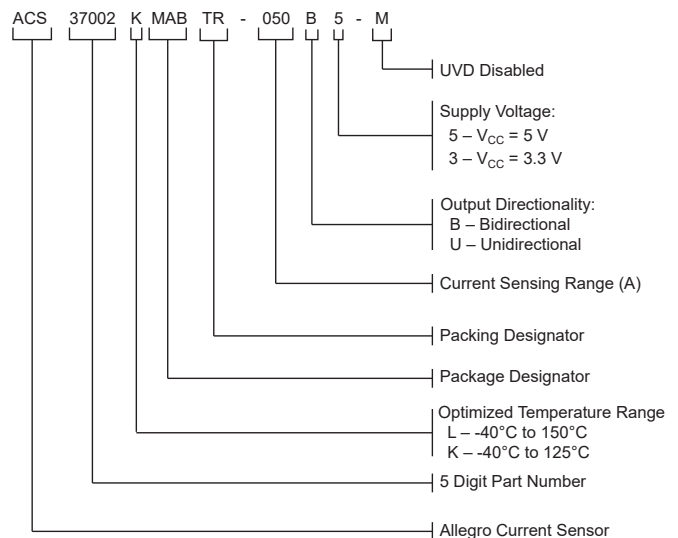
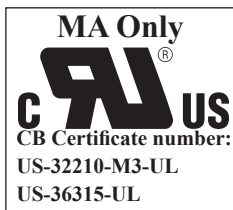

Figure 1: Typical Bidirectional Application Showing 00 Gain Select Configuration.
For more application circuits, refer to the Application and Theory section.

FEATURES AND BENEFITS (continued)

- Enabling measurement ranges from 10 to 133 A in both unidirectional and bidirectional modes
- Low internal primary conductor resistance 0.85 mΩ (MA) and 1 mΩ (LA) for better power efficiency
- UL 62368-1:2014 (ed. 2) certification, highly isolated compact SOICW-16 surface mount package (MA)
 - 3125 V_{RMS} rated dielectric withstand voltage
 - 1097 V_{RMS} / 1550 V_{DC} basic insulation voltages
 - 565 V_{RMS} / 800 V_{DC} reinforced insulation voltages
- Wide operating temperature, -40°C to 150°C
- AEC-Q100 Grade 0, automotive qualified



SELECTION GUIDE

Part Number ^[1]	Current Sensing Range, I _{PR} (A)	Sensitivity ^[2] (mV/A)	Nominal V _{CC} (V)	Optimized Temp. Range T _A (°C)	Packing ^[3]
MA Package, 16-Pin SOICW					
ACS37002LMABTR-050B5-M	±33, ±40, ±50, ±66	60, 50, 40, 30	5	-40 to 150	1000 pieces per 13-inch reel
ACS37002LMABTR-066B5-M	±66, ±80, ±100, ±133	30, 25, 20, 15			
ACS37002LMABTR-050U5-M	33, 40, 50, 66	120, 100, 80, 60			
ACS37002LMABTR-066U5-M	66, 80, 100, 133	60, 50, 40, 30			
ACS37002LMABTR-050B3	±33, ±40, ±50, ±66	39.6, 33, 26.4, 19.8	3.3		
ACS37002LMABTR-066B3	±66, ±80, ±100, ±133	19.8, 16.5, 13.2, 9.9			
ACS37002LMABTR-050U3	33, 40, 50, 66	79.2, 66, 52.8, 39.6			
ACS37002LMABTR-066U3	66, 80, 100, 133	39.6, 33, 26.4, 19.8			
ACS37002KMABTR-050B5-M	±33, ±40, ±50, ±66	60, 50, 40, 30	5	-40 to 125 ^[3]	
ACS37002KMABTR-050B3	±33, ±40, ±50, ±66	39.6, 33, 26.4, 19.8	3.3		
LA Package, 16-Pin SOICW					
ACS37002LLAATR-015B5	±10, ±12, ±15, ±20	200, 166.6, 133.3, 100	5	-40 to 150	1000 pieces per 13-inch reel
ACS37002LLAATR-025B5	±25, ±30, ±37.5, ±50	80, 66.6, 53.3, 40			
ACS37002LLAATR-015B3	±10, ±12, ±15, ±20	132, 110, 88, 66	3.3		
ACS37002LLAATR-025U3	25, 30, 37.5, 50	105.6, 88, 70.4, 52.8			

^[1] Part numbers both with and without -M have UVD functionality disable.

^[2] Refer to the part specific performance characteristics sections for Gain_Sel configuration.

^[3] The device performance is optimized from -40°C to 125°C; however, the device can still operate to an ambient temperature of 150°C. The device shares the same qualifications as the L temperature devices unless otherwise stated.

Table of Contents

Features and Benefits.....	1	Power Supply Offset Error (V_{PS})	30
Description	1	Offset Power Supply Rejection Ratio (PSRRO).....	30
Packages	1	Power Supply Sensitivity Error (EPS)	30
Selection Guide	2	Sensitivity Power Supply Rejection Ratio (PSRRS)	30
Absolute Maximum Ratings	4	Fault Behavior	31
Isolation and Package Characteristics	5	Overcurrent Fault (OCF)	31
MA Package Specific Performance.....	5	Overcurrent Fault Operating Range/Point (I_{OCF-OR} , I_{OCF-OP})..	31
LA Package Specific Performance.....	5	Overcurrent Fault Hysteresis ($I_{OCF-Hyst}$).....	31
Pinout Diagram and Terminal List.....	6	Voltage Overcurrent Pin (VOC)	31
Functional Block Diagram	7	Overcurrent Fault Error (E_{OCF}).....	32
Common Electrical Characteristics	8	Overcurrent Fault Response Time (t_{OCF}).....	32
Performance Characteristics.....	11	Overcurrent Fault Reaction Time (t_{OCF-R})	32
Functional Description	25	Overcurrent Fault Mask Time ($t_{OCF-MASK}$)	32
Power-On Reset Operation	25	Overcurrent Fault Hold Time ($t_{OCF-HOLD}$).....	32
Power-On/Power-Off.....	25	Overcurrent Fault Persist.....	32
Overvoltage Detection (OVD).....	26	OCF Disable	32
Absolute Maximum Ratings	27	Response Characteristics Definitions and Performance Data... 33	
Supply Zener Clamp Voltages	27	Response Time ($t_{RESPONSE}$)	33
Forward and Reverse Supply Voltage	27	Propagation Time (t_{pd})	33
Forward and Reverse Output Voltage	27	Rise Time (t_R).....	33
Forward and Reverse Reference/Fault Voltage	27	Output Slew Rate (SR)	33
Output Source and Sink Current.....	27	Temperature Compensation	34
Definitions of Operating and Performance Characteristics	28	Temperature Compensation Update Rate	34
Zero Current Voltage Output ($V_{IOUT(Q)}$, QVO)	28	Application and Theory	35
QVO Temperature Drift (V_{QE})	28	Application Circuits.....	35
Reference Voltage (V_{REF})	28	Theory and Functionality – VOC and OCF	36
Reference Voltage Temperature Drift (VRE)	28	VOC Driven by Non-Inverting Buffered VREF	36
Offset Voltage (VOE).....	28	Power Supply Decoupling Capacitor and	
Output Saturation Voltage ($V_{SAT(HIGH/LOW)}$).....	28	Output Capacitive Loads	36
Output Voltage Operating Range (V_{OOR}).....	28	Dynamically Change Gain in a System	37
Sensitivity (Sens).....	29	Thermal Performance	38
Sensitivity Error (E_{sens})	29	Thermal Rise vs. Primary Current	38
Gain Selection Pins.....	29	Evaluation Board Layout	38
Full Scale (FS).....	29	Package Outline Drawings	39
Nonlinearity (E_{LIN}).....	29	MA Package.....	39
Total Output Error (E_{TOT}).....	30	LA Package.....	40

ABSOLUTE MAXIMUM RATINGS

Characteristic	Symbol	Notes	Rating	Unit
Forward Supply Voltage	V_{FCC}		6.5	V
Reverse Supply Voltage	V_{RCC}		-0.5	V
Forward Output Voltage	V_{FIOUT}	Applies to V_{IOUT} , V_{OCF} , and V_{REF}	$(V_{CC} + 0.7) \leq 6.5$	V
Reverse Output Voltage	V_{RIOUT}	Applies to V_{IOUT} , V_{OCF} , and V_{REF}	-0.5	V
Forward Input Voltage	V_{FI}	Applies to GAIN_SEL0, GAIN_SEL1, and VOC	$(V_{CC} + 0.7) \leq 6.5$	V
Reverse Input Voltage	V_{RI}	Applies to GAIN_SEL0, GAIN_SEL1, and VOC	-0.5	V
Operating Ambient Temperature	T_A		-40 to 150	°C
Storage Temperature	T_{stg}		-65 to 165	°C
Maximum Junction Temperature	$T_{J(max)}$		165	°C

THERMAL CHARACTERISTICS

Characteristic	Symbol	Notes	Value	Unit
MA Package, 16-Pin SOICW				
Package Thermal Resistance (Junction to Ambient)	$R_{\theta JA}$	Mounted on the standard MA/LA Current Sensor Evaluation Board (ACSEVB-MA16-LA16)	20	°C/W
Package Thermal Metric (Junction to Top)	Ψ_{JT}		2.4	°C/W
Package Thermal Resistance (Junction to Case)	$R_{\theta JC}$	Simulated per the methods in JESD51-1	14	°C/W
Package Thermal Resistance (Junction to Board)	$R_{\theta JB}$	Simulated per the methods in JESD51-8	14	°C/W
LA Package, 16-Pin SOICW				
Package Thermal Resistance (Junction to Ambient)	$R_{\theta JA}$	Mounted on the standard MA/LA Current Sensor Evaluation Board (ACSEVB-MA16-LA16)	16	°C/W
Package Thermal Characterization (Junction to Top)	Ψ_{JT}		-1.7	°C/W
Package Thermal Resistance (Junction to Case)	$R_{\theta JC}$	Simulated per the methods in JESD51-1	10	°C/W
Package Thermal Resistance (Junction to Board)	$R_{\theta JB}$	Simulated per the methods in JESD51-8	8	°C/W

ISOLATION AND PACKAGE CHARACTERISTICS

Characteristic	Symbol	Notes	Rating	Unit
Dielectric Surge Voltage	V_{SURGE}	Tested in oil, ± 5 pulses at 2/minute in compliance to IEC 61000-4-5 1.2 μs (rise) / 50 μs (width)	10	kV
Moisture Sensitivity Level	MSL	Per IPC/JEDEC J-STD-020	3	–

MA PACKAGE SPECIFIC PERFORMANCE

Characteristic	Symbol	Notes	Rating	Unit
Withstand Voltage ^{[1][2]}	V_{ISO}	Agency rated for 60 seconds per UL 62368-1 (edition 3) ^{[1][2]}	5000	V_{RMS}
Working Voltage for Basic Insulation ^[2]	V_{WVBI}	Maximum approved working voltage for basic insulation according to UL 62368-1 (edition 3)	1550	V_{PK} or V_{DC}
			1097	V_{RMS}
Working Voltage for Reinforced Insulation ^[2]	V_{WVRI}	Maximum approved working voltage for reinforced insulation according to UL 62368-1 (edition 3)	800	V_{PK} or V_{DC}
			565	V_{RMS}
Clearance	D_{CL}	Minimum distance through air from IP leads to signal leads	8	mm
Creepage	D_{CR}	Minimum distance along package body from IP leads to signal leads	8	mm
Distance Through Insulation	DTI	Minimum internal distance through insulation	90	μm
Comparative Track Index	CTI	Material Group II	400 to 599	V

^[1] Production tested for 1 second in accordance with UL 62368-1 (edition 3).

^[2] Certification pending.

LA PACKAGE SPECIFIC PERFORMANCE

Characteristic	Symbol	Notes	Rating	Unit
Withstand Voltage ^{[1][2]}	V_{ISO}	Agency rated for 60 seconds per UL 62368-1 (edition 3) ^{[1][2]}	4242	V_{RMS}
Working Voltage for Basic Insulation ^[2]	V_{WVBI}	Maximum approved working voltage for basic insulation according to UL 62368-1 (edition 3)	1414	V_{PK} or V_{DC}
			1000	V_{RMS}
Working Voltage for Reinforced Insulation ^[2]	V_{WVRI}	Maximum approved working voltage for reinforced insulation according to UL 62368-1 (edition 3)	707	V_{PK} or V_{DC}
			500	V_{RMS}
Impulse Withstand Voltage ^[1]	$V_{IMPULSE}$	Tested in air, ± 5 pulses at 2/minute in compliance to IEC 61000-4-5 1.2 μs (rise) / 50 μs (width)	6000	V_{PK}
Clearance	D_{cl}	Minimum distance through air from IP leads to signal leads	7.9	mm
Creepage	D_{cr}	Minimum distance along package body from IP leads to signal leads	7.9	mm
Distance Through Insulation	DTI	Minimum internal distance through insulation	64	μm
Comparative Track Index	CTI	Material Group II	400 to 599	V

^[1] Production tested for 1 second in accordance with UL 62368-1 (edition 3).

^[2] Certification pending.

PINOUT DIAGRAM AND TERMINAL LIST TABLE

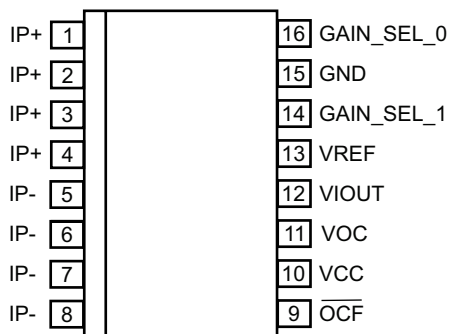

Figure 2: MA/LA Pinout Diagram

Terminal List Table

Number	Name	Description
1, 2, 3, 4	IP+	Terminals for current being sensed; fused internally
5, 6, 7, 8	IP-	Terminals for current being sensed; fused internally
9	$\overline{\text{OCF}}$	Overcurrent fault, open-drain
10	VCC	Device power supply terminal
11	VOC	Overcurrent fault operation point input
12	VIOUT	Analog output representing the current flowing through I_p
13	VREF	Zero current voltage reference
14	GAIN_SEL_1	Gain selection bit 1
15	GND	Device ground terminal
16	GAIN_SEL_0	Gain selection bit 0

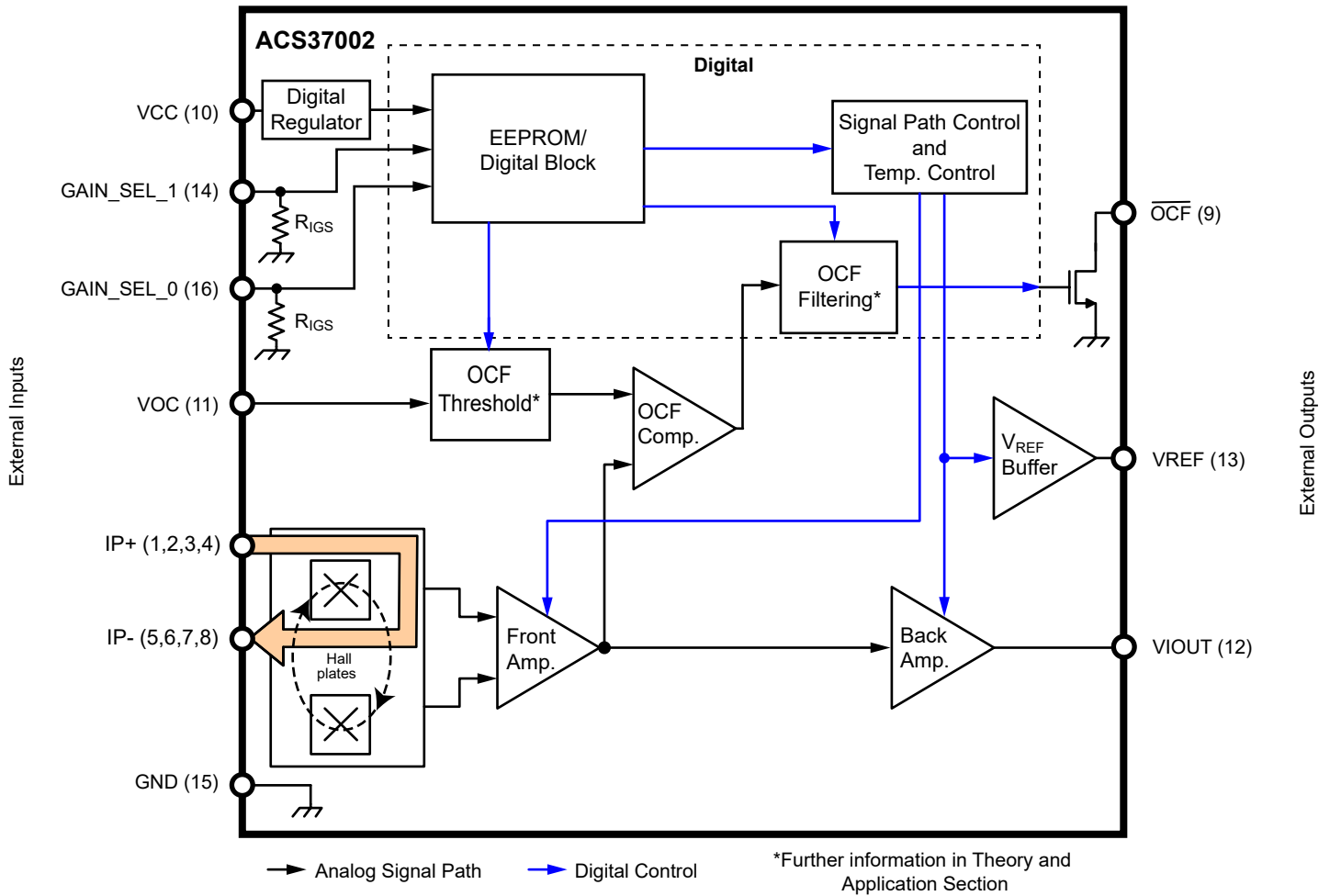

Figure 3: Functional Block Diagram

COMMON ELECTRICAL CHARACTERISTICS: Valid through full operating temperature range, $T_A = -40^{\circ}\text{C}$ to 150°C , $C_{\text{BYPASS}} = 0.1 \mu\text{F}$, and $V_{\text{CC}} = 5 \text{ V}$ or 3.3 V , unless otherwise specified

Characteristic	Symbol	Test Conditions	Min.	Typ.	Max.	Units
Supply Voltage	V_{CC}	5 V devices only	4.5	5	5.5	V
		3.3 V devices only	3.15	3.3	3.6	V
Supply Current	I_{CC}	No load on VIOOUT or VREF; $V_{\text{CC}} = 5 \text{ V}$	–	13	18	mA
		No load on VIOOUT or VREF; $V_{\text{CC}} = 3.3 \text{ V}$	–	12	15	mA
Supply Bypass Capacitor	C_{BYPASS}	VCC to GND recommended	0.1	–	–	μF
Output Resistive Load	R_{L}	VIOOUT to GND, VIOOUT to VCC	10	–	–	k Ω
Output Capacitive Load	C_{L}	VIOOUT to GND	–	1	6	nF
Reference Resistive Load	R_{VREF}	VREF to GND (recommended to supply VOC); VREF to VCC	10	–	–	k Ω
Reference Capacitive Load	C_{VREF}	VREF to GND	–	–	6	nF
Fault Pull-Up Resistance	R_{PU}		4.7	–	500	k Ω
Primary Conductor Resistance	R_{IP}	MA, $T_A = 25^{\circ}\text{C}$	–	0.85	–	m Ω
		LA, $T_A = 25^{\circ}\text{C}$	–	1	–	m Ω
Primary Conductor Inductance	L_{IP}	MA package	–	4.2	–	nH
		LA package	–	5	–	nH
Output Buffer Resistance	R_{OUT}	Internal output buffer resistance on VIOOUT and VREF	–	4	–	Ω
Power-On Reset Voltage	$V_{\text{POR(H)}}$	V_{CC} rising [1]	2.6	2.9	3.1	V
	$V_{\text{POR(L)}}$	V_{CC} falling [1]	2.2	2.5	2.8	V
POR Hysteresis	$V_{\text{POR(HYS)}}$		250	–	–	mV
Power-On Time	t_{POD}	Time from V_{CC} rising $\geq V_{\text{POR(H)}}$ after a POR event until power-on; VREF, OCF, VIOOUT	100	–	–	μs
Overvoltage Detection (OVD) Threshold	$V_{\text{OVD(H)}}$	$T_A = 25^{\circ}\text{C}$, V_{CC} rising [1]	6.1	6.3	6.8	V
	$V_{\text{OVD(L)}}$	$T_A = 25^{\circ}\text{C}$, V_{CC} falling [1]	5.6	5.8	6.1	V
Overvoltage Detection Hysteresis	$V_{\text{OVD(HYS)}}$		–	660	–	mV
OVD Delay Time	$t_{\text{dOVD(E)}}$	Time from V_{CC} rising $\geq V_{\text{OVD(EN)}}$ until OVD asserts	35	90	120	μs
	$t_{\text{dOVD(D)}}$	Time from V_{CC} falling $\leq V_{\text{OVD(DIS)}}$ until OVD clears	–	7	–	μs

Continued on the next page...

COMMON PERFORMANCE CHARACTERISTICS (VIOUT): Valid through full operating temperature range, $T_A = -40^\circ\text{C}$ to 150°C , $C_{\text{BYPASS}} = 0.1 \mu\text{F}$, and $V_{\text{CC}} = 5 \text{ V}$ or 3.3 V , unless otherwise specified

Characteristic	Symbol	Test Conditions	Min.	Typ.	Max.	Units	
OUTPUT SIGNAL CHARACTERISTICS (V_{IOUT})							
Saturation Voltage	$V_{\text{SAT(H)}}$	$R_L = 10 \text{ k}\Omega$ to GND	$V_{\text{CC}} - 0.25$	–	–	V	
	$V_{\text{SAT(L)}}$	$R_L = 10 \text{ k}\Omega$ to V_{CC}	–	–	0.15	V	
Output Operating Range	V_{OOR}	5 V linear operating range	0.5	–	4.5	V	
		3.3 V linear operating range	0.3	–	3.0	V	
Output Current Limit	$I_{\text{OUT(src)}}$	V_{IOUT} shorted to GND	–	25	–	mA	
	$I_{\text{OUT(snk)}}$	V_{IOUT} shorted to V_{CC}	–	25	–	mA	
Bandwidth	BW	Small signal –3 dB, $C_L = 6 \text{ nF}$	–	400	–	kHz	
Rise Time	t_R	$T_A = 25^\circ\text{C}$, $C_L = 6 \text{ nF}$	–	0.7	2.5	μs	
Response Time	t_{RESPONSE}	$T_A = 25^\circ\text{C}$, $C_L = 6 \text{ nF}$	–	1.1	2.5	μs	
Propagation Delay	t_{pd}	$T_A = 25^\circ\text{C}$, $C_L = 6 \text{ nF}$	–	0.7	2	μs	
Noise Density	I_{ND}	Input-referenced noise density; $T_A = 25^\circ\text{C}$, $C_L = 6 \text{ nF}$; $V_{\text{CC}} = 5 \text{ V}$	MA Package	–	350	–	$\mu\text{A}/\sqrt{\text{Hz}}$
			LA Package	–	155	–	$\mu\text{A}/\sqrt{\text{Hz}}$
		Input-referenced noise density; $T_A = 25^\circ\text{C}$, $C_L = 6 \text{ nF}$; $V_{\text{CC}} = 3.3 \text{ V}$	MA Package	–	450	–	$\mu\text{A}/\sqrt{\text{Hz}}$
			LA Package	–	200	–	$\mu\text{A}/\sqrt{\text{Hz}}$
Noise	I_{N}	Input-referenced noise at 400 kHz; $T_A = 25^\circ\text{C}$, $C_L = 6 \text{ nF}$; $V_{\text{CC}} = 5 \text{ V}$	MA Package	–	277	–	mA_{RMS}
			LA Package	–	124	–	mA_{RMS}
		Input-referenced noise at 400 kHz; $T_A = 25^\circ\text{C}$, $C_L = 6 \text{ nF}$; $V_{\text{CC}} = 3.3 \text{ V}$	MA Package	–	357	–	mA_{RMS}
			LA Package	–	160	–	mA_{RMS}
Nonlinearity	E_{LIN}		–	± 0.75	–	%	
Power Supply Rejection Ratio Offset	PSRR_O	$T_A = 25^\circ\text{C}$, DC to 1 kHz, 100 mV pk-pk ripple around $V_{\text{CC}} = V_{\text{CC(typ)}}$; $I_P = 0 \text{ A}$	–	–40	–	dB	
		$T_A = 25^\circ\text{C}$, 1 to 100 kHz, 100 mV pk-pk ripple around $V_{\text{CC}} = V_{\text{CC(typ)}}$; $I_P = 0 \text{ A}$	–	–30	–	dB	
Power Supply Rejection Ratio Sens	PSRR_S	$T_A = 25^\circ\text{C}$, DC to 1 kHz, 100 mV pk-pk ripple around $V_{\text{CC}} = V_{\text{CC(typ)}}$; $I_P = I_{\text{PR(MAX)}}$	–	–15	–	dB	
		$T_A = 25^\circ\text{C}$, 1 to 100 kHz, 100 mV pk-pk ripple around $V_{\text{CC}} = V_{\text{CC(typ)}}$; $I_P = I_{\text{PR(MAX)}}$	–	–6	–	dB	
Power Supply Offset Error	$V_{\text{OE(PS)}}$	Bidirectional; $V_{\text{CC}} @ V_{\text{CC(MIN)}}$ or $V_{\text{CC(MAX)}}$	–10	–	10	mV	
		Unidirectional; $V_{\text{CC}} @ V_{\text{CC(MIN)}}$ or $V_{\text{CC(MAX)}}$	MA Package	–18	–	18	mV
			LA Package	–10	–	10	mV
Power Supply Sensitivity Error	$E_{\text{SENS(PS)}}$	$V_{\text{CC}} @ V_{\text{CC(MIN)}}$ or $V_{\text{CC(MAX)}}$	–1.5	–	1.5	%	
Common-Mode Field Rejection	CMFR	Input-referred error due to common-mode field	–	4	–	mA/G	

Continued on the next page...

COMMON PERFORMANCE CHARACTERISTICS (VREF, FAULT, GAIN_SEL): Valid through full operating temperature range, $T_A = -40^\circ\text{C}$ to 150°C , $C_{\text{BYPASS}} = 0.1 \mu\text{F}$, and $V_{\text{CC}} = 5 \text{ V}$ or 3.3 V , unless otherwise specified

Characteristic	Symbol	Test Conditions	Min.	Typ.	Max.	Units
REFERENCE OUTPUT CHARACTERISTICS (VREF)						
Zero Current Reference Voltage	$V_{\text{REF(BI)}}$	Bidirectional; $V_{\text{CC}} = 5 \text{ V}$	2.49	2.5	2.51	V
		Bidirectional; $V_{\text{CC}} = 3.3 \text{ V}$	1.64	1.65	1.66	V
	$V_{\text{REF(UNI)}}$	Unidirectional; $V_{\text{CC}} = 5 \text{ V}$	0.49	0.5	0.51	V
		Unidirectional; $V_{\text{CC}} = 3.3 \text{ V}$	0.32	0.33	0.34	V
Reference Source Current Limit	$I_{\text{REF(SRC)}}$	Maximum current V_{REF} can passively source	–	25	–	mA
	$I_{\text{REF(SNK)}}$	Maximum current V_{REF} can passively sink	–	–25	–	mA
Reference Slew Rate	SR_{REF}	$C_{\text{VREF}} = 0 \text{ nF}$, $R_{\text{VREF}} = 0 \Omega$	0.8	–	–	V/ μs
OVERCURRENT FAULT CHARACTERISTICS (OCF)						
OCF On Voltage ^[3]	$V_{\text{FAULT-ON}}$	$R_{\text{PU}} = 4.7 \text{ k}\Omega$, under fault condition	–	0.07	0.4	V
OCF Sink Current ^[3]	$I_{\text{OCF(SNK)}}$	No Fault	–	100	–	nA
		Fault Assertion	0.01	–	1.1	mA
VOC Operating Voltage Range	V_{VOC}	$V_{\text{CC}} = 5 \text{ V}$	0.5	–	2	V
		$V_{\text{CC}} = 3.3 \text{ V}$	0.33	–	1.32	V
Fault Error	E_{OCF}		–10	± 3	10	% $I_{\text{OCF-OP}}$
OCF Hysteresis	$I_{\text{OCF(HYS)}}$	$V_{\text{CC}} = 5 \text{ V}$	–	6	–	%FS
		$V_{\text{CC}} = 3.3 \text{ V}$	–	9	–	%FS
OCF Reaction Time ^[3]	$t_{\text{OCF-R}}$	Time from $I_{\text{OCF-OP}}$ with a $1.2 \times I_{\text{OCF-OP}}$ until fault asserts	–	1	1.5	μs
OCF Mask ^[3]	$t_{\text{OCF-MASK}}$	Time $I_{\text{OCF-OP}}$ must be present after $t_{\text{OCF-R}}$ for fault assertion ^[3]	0	0	3	μs
OCF Response Time ^[3]	t_{OCF}	$t_{\text{OCF-MASK}} = 0 \mu\text{s}$	–	1	1.5	μs
OCF Hold Time ^[3]	$t_{\text{OCF-HOLD}}$	Minimum duration of FAULT assertion ^[2]	0	0	5	ms
GAIN SELECTION PIN CHARACTERISTICS (GAIN_SEL0, GAIN_SEL1)						
Gain Select Internal Resistor	R_{GSint}		–	1	–	M Ω
GAIN_SEL Logic Input Voltage	$V_{\text{H(SEL)}}$	$V_{\text{CC}} = 5 \text{ V}$	3.75	–	–	V
		$V_{\text{CC}} = 3.3 \text{ V}$	2.25	–	–	V
	$V_{\text{L(SEL)}}$		–	–	0.5	V
Leakage Current ^[3]	$I_{\text{SEL(SNK)}}$		–	–	± 10	μA

^[1] V_{CC} rate +1 V/ms, for best accuracy.

^[2] Typical value is factory default.

^[3] Guaranteed by design and bench validated

ACS37002LMABTR-050B5-M

ACS37002LMABTR-050B5-M Gain_Sel Pin Performance Key

ACS37002LMABTR-050B5-M Gain_Sel Pin Performance Key				Selection Identifier	
Parameter (Units)	Gain_Sel_1 (Boolean)	Gain_Sel_0 (Boolean)	Sens (mV/A)	Max IP (A)	
Type	Digital Input	Digital Input	Calculation	Bidirectional	
Selection Combination	0	0	40	50	
	0	1	50	40	
	1	0	60	33.3	
	1	1	30	66.7	

ACS37002LMABTR-050B5-M PERFORMANCE CHARACTERISTICS: Valid through full operating temperature range, $T_A = -40^\circ\text{C}$ to 150°C , $C_{\text{BYPASS}} = 0.1 \mu\text{F}$, and $V_{\text{CC}} = 5 \text{ V}$, unless otherwise specified

Characteristic	Symbol	Test Conditions	Minimum		Typ.	Maximum		Units
			Absolute Min. ^[1]	-3σ ^[2]		$+3\sigma$ ^[2]	Absolute Max. ^[1]	
NOMINAL PERFORMANCE								
Current Sensing Range	I_{PR}	Gain Sel 00	-50	-	-	-	50	A
		Gain Sel 01	-40	-	-	-	40	A
		Gain Sel 10	-33.3	-	-	-	33.3	A
		Gain Sel 11	-66.7	-	-	-	66.7	A
Sensitivity	Sens	Gain Sel 00; $I_{\text{PR}(\text{min})} < I_{\text{P}} < I_{\text{PR}(\text{max})}$	-	-	40	-	-	mV/A
		Gain Sel 01; $I_{\text{PR}(\text{min})} < I_{\text{P}} < I_{\text{PR}(\text{max})}$	-	-	50	-	-	mV/A
		Gain Sel 10; $I_{\text{PR}(\text{min})} < I_{\text{P}} < I_{\text{PR}(\text{max})}$	-	-	60	-	-	mV/A
		Gain Sel 11; $I_{\text{PR}(\text{min})} < I_{\text{P}} < I_{\text{PR}(\text{max})}$	-	-	30	-	-	mV/A
Overcurrent Fault Operating Range	$I_{\text{OCF-OR}}$	Typ. = factory-programmed default, FS = Full-Scale	50	-	100	-	200	%FS
Zero Current Output Voltage	$V_{\text{IOUT(Q)}}$	Bidirectional; $I_{\text{P}} = 0 \text{ A}$, $T_A = 25^\circ\text{C}$	-	-	2.5	-	-	V
TOTAL ERROR ($V_{\text{IOUT(ACTUAL)}} - (\text{Sens}_{(\text{IDEAL})} \times I_{\text{PR}} + V_{\text{REF}})$) / ($\text{Sens}_{(\text{IDEAL})} \times I_{\text{PR}}) \times 100$ AND TOTAL ERROR COMPONENTS								
Total Error	E_{TOT}	$I_{\text{P}} = I_{\text{PR}(\text{max})}$	-1.75	-1.1	-	1.1	1.75	%
Sensitivity Error	E_{SENS}	$I_{\text{P}} = I_{\text{PR}(\text{max})}$, $T_A = 25^\circ\text{C}$ to 150°C or -40°C to 25°C	-1.5	-1.1	-	1.1	1.5	%
Zero Current Reference Error	V_{RE}	$V_{\text{REFactual}} - V_{\text{REFideal}}$, $I_{\text{P}} = 0 \text{ A}$, $T_A = 25^\circ\text{C}$ to 150°C	-10	-5	-	5	10	mV
		$V_{\text{REFactual}} - V_{\text{REFideal}}$, $I_{\text{P}} = 0 \text{ A}$, $T_A = -40^\circ\text{C}$ to 25°C	-10	-4	-	4	10	mV
Offset Error	V_{OE}	$V_{\text{IOUT(Q)}} - V_{\text{REF}}$, $I_{\text{P}} = 0 \text{ A}$, $T_A = 25^\circ\text{C}$ to 150°C	-8	-5	-	5	8	mV
		$V_{\text{IOUT(Q)}} - V_{\text{REF}}$, $I_{\text{P}} = 0 \text{ A}$, $T_A = -40^\circ\text{C}$ to 25°C	-8	-4	-	4	8	mV
QVO Error	V_{QE}	$V_{\text{IOUT(Q)}}$, $I_{\text{P}} = 0 \text{ A}$, $T_A = 25^\circ\text{C}$ to 150°C	-10	-8	-	8	10	mV
		$V_{\text{IOUT(Q)}}$, $I_{\text{P}} = 0 \text{ A}$, $T_A = -40^\circ\text{C}$ to 25°C	-10	-5	-	5	10	mV
TOTAL ERROR AND TOTAL ERROR COMPONENTS INCLUDING LIFETIME DRIFT [1, 2]								
Total Error Including Lifetime Drift	$E_{\text{TOT_LTD}}$	$I_{\text{P}} = I_{\text{PR}(\text{max})}$	-3.6	-2.8	-	2.8	3.6	%
Sensitivity Error Including Lifetime Drift	$E_{\text{SENS_LTD}}$	$I_{\text{P}} = I_{\text{PR}(\text{max})}$, $T_A = 25^\circ\text{C}$ to 150°C or -40°C to 25°C	-3.4	-2.6	-	2.6	3.4	%
Zero Current Reference Error Including Lifetime Drift	$V_{\text{RE_LTD}}$	$V_{\text{REFactual}} - V_{\text{REFideal}}$, $I_{\text{P}} = 0 \text{ A}$, $T_A = 25^\circ\text{C}$ to 150°C	-10	-7	-	7	10	mV
		$V_{\text{REFactual}} - V_{\text{REFideal}}$, $I_{\text{P}} = 0 \text{ A}$, $T_A = -40^\circ\text{C}$ to 25°C	-10	-5	-	5	10	mV
Offset Error Including Lifetime Drift	$V_{\text{OE_LTD}}$	$V_{\text{IOUT(Q)}} - V_{\text{REF}}$, $I_{\text{P}} = 0 \text{ A}$, $T_A = 25^\circ\text{C}$ to 150°C	-10	-7	-	7	10	mV
		$V_{\text{IOUT(Q)}} - V_{\text{REF}}$, $I_{\text{P}} = 0 \text{ A}$, $T_A = -40^\circ\text{C}$ to 25°C	-10	-8	-	8	10	mV
QVO Error Including Lifetime Drift	$V_{\text{QE_LTD}}$	$V_{\text{IOUT(Q)}}$, $I_{\text{P}} = 0 \text{ A}$, $T_A = 25^\circ\text{C}$ to 150°C	-14	-10	-	10	14	mV
		$V_{\text{IOUT(Q)}}$, $I_{\text{P}} = 0 \text{ A}$, $T_A = -40^\circ\text{C}$ to 25°C	-10	-7	-	7	10	mV

[1] Absolute Min. and Absolute Max are the production limits in which the device will not exceed.

[2] -3σ and $+3\sigma$ are mean $\pm 3\sigma$ values and are determined such that 99.73% of devices lie within the interval during initial characterization.

[3] Lifetime drift characteristics are based on a statistical combination of production distributions and worst case distribution of parametric drift of individuals observed during AEC-Q100 qualification.

ACS37002LMABTR-066B5-M

ACS37002LMABTR-066B5-M Gain_Sel Pin Performance Key

				Selection Identifier	
Parameter (Units)	Gain_Sel_1 (Boolean)	Gain_Sel_0 (Boolean)	Sens (mV/A)	Max IP (A)	
Type	Digital Input	Digital Input	Calculation	Bidirectional	
Selection Combination	0	0	30	66.7	
	0	1	25	80	
	1	0	20	100	
	1	1	15	133.3	

ACS37002LMABTR-066B5-M PERFORMANCE CHARACTERISTICS: Valid through full operating temperature range, $T_A = -40^\circ\text{C}$ to 150°C , $C_{\text{BYPASS}} = 0.1 \mu\text{F}$, and $V_{\text{CC}} = 5 \text{ V}$, unless otherwise specified

Characteristic	Symbol	Test Conditions	Minimum		Typ.	Maximum		Units
			Absolute Min. ^[1]	-3 σ ^[2]		+3 σ ^[2]	Absolute Max. ^[1]	
NOMINAL PERFORMANCE								
Current Sensing Range	I_{PR}	Gain Sel 00	-66.7	-	-	-	66.7	A
		Gain Sel 01	-80	-	-	-	80	A
		Gain Sel 10	-100	-	-	-	100	A
		Gain Sel 11	-133.3	-	-	-	133.3	A
Sensitivity	Sens	Gain Sel 00; $I_{\text{PR}(\text{min})} < I_{\text{P}} < I_{\text{PR}(\text{max})}$	-	-	30	-	-	mV/A
		Gain Sel 01; $I_{\text{PR}(\text{min})} < I_{\text{P}} < I_{\text{PR}(\text{max})}$	-	-	25	-	-	mV/A
		Gain Sel 10; $I_{\text{PR}(\text{min})} < I_{\text{P}} < I_{\text{PR}(\text{max})}$	-	-	20	-	-	mV/A
		Gain Sel 11; $I_{\text{PR}(\text{min})} < I_{\text{P}} < I_{\text{PR}(\text{max})}$	-	-	15	-	-	mV/A
Overcurrent Fault Operating Range	$I_{\text{OCF-OR}}$	Typ. = factory-programmed default, FS = Full-Scale	50	-	100	-	200	%FS
Zero Current Output Voltage	$V_{\text{IOUT(Q)}}$	Bidirectional; $I_{\text{P}} = 0 \text{ A}$, $T_A = 25^\circ\text{C}$	-	-	2.5	-	-	V
TOTAL ERROR ($V_{\text{IOUT(ACTUAL)}} - (\text{Sens}_{(\text{IDEAL})} \times I_{\text{PR}} + V_{\text{REF}})$) / ($\text{Sens}_{(\text{IDEAL})} \times I_{\text{PR}}$) \times 100 AND TOTAL ERROR COMPONENTS								
Total Error	E_{TOT}	$I_{\text{P}} = I_{\text{PR}(\text{max})}$	-1.75	-1.1	-	1.1	1.75	%
Sensitivity Error	E_{SENS}	$I_{\text{P}} = I_{\text{PR}(\text{max})}$, $T_A = 25^\circ\text{C}$ to 150°C or -40°C to 25°C	-1.5	-1.1	-	1.1	1.5	%
Zero Current Reference Error	V_{RE}	$V_{\text{REFactual}} - V_{\text{REFideal}}$, $I_{\text{P}} = 0 \text{ A}$, $T_A = 25^\circ\text{C}$ to 150°C	-10	-5	-	5	10	mV
		$V_{\text{REFactual}} - V_{\text{REFideal}}$, $I_{\text{P}} = 0 \text{ A}$, $T_A = -40^\circ\text{C}$ to 25°C	-10	-4	-	4	10	mV
Offset Error	V_{OE}	$V_{\text{IOUT(Q)}} - V_{\text{REF}}$, $I_{\text{P}} = 0 \text{ A}$, $T_A = 25^\circ\text{C}$ to 150°C	-8	-5	-	5	8	mV
		$V_{\text{IOUT(Q)}} - V_{\text{REF}}$, $I_{\text{P}} = 0 \text{ A}$, $T_A = -40^\circ\text{C}$ to 25°C	-8	-4	-	4	8	mV
QVO Error	V_{QE}	$V_{\text{IOUT(Q)}}$, $I_{\text{P}} = 0 \text{ A}$, $T_A = 25^\circ\text{C}$ to 150°C	-10	-8	-	8	10	mV
		$V_{\text{IOUT(Q)}}$, $I_{\text{P}} = 0 \text{ A}$, $T_A = -40^\circ\text{C}$ to 25°C	-10	-5	-	5	10	mV
TOTAL ERROR AND TOTAL ERROR COMPONENTS INCLUDING LIFETIME DRIFT [1, 2]								
Total Error Including Lifetime Drift	$E_{\text{TOT_LTD}}$	$I_{\text{P}} = I_{\text{PR}(\text{max})}$	-3.6	-2.8	-	2.8	3.6	%
Sensitivity Error Including Lifetime Drift	$E_{\text{SENS_LTD}}$	$I_{\text{P}} = I_{\text{PR}(\text{max})}$, $T_A = 25^\circ\text{C}$ to 150°C or -40°C to 25°C	-3.4	-2.6	-	2.6	3.4	%
Zero Current Reference Error Including Lifetime Drift	$V_{\text{RE_LTD}}$	$V_{\text{REFactual}} - V_{\text{REFideal}}$, $I_{\text{P}} = 0 \text{ A}$, $T_A = 25^\circ\text{C}$ to 150°C	-10	-7	-	7	10	mV
		$V_{\text{REFactual}} - V_{\text{REFideal}}$, $I_{\text{P}} = 0 \text{ A}$, $T_A = -40^\circ\text{C}$ to 25°C	-10	-5	-	5	10	mV
Offset Error Including Lifetime Drift	$V_{\text{OE_LTD}}$	$V_{\text{IOUT(Q)}} - V_{\text{REF}}$, $I_{\text{P}} = 0 \text{ A}$, $T_A = 25^\circ\text{C}$ to 150°C	-10	-7	-	7	10	mV
		$V_{\text{IOUT(Q)}} - V_{\text{REF}}$, $I_{\text{P}} = 0 \text{ A}$, $T_A = -40^\circ\text{C}$ to 25°C	-10	-4	-	4	10	mV
QVO Error Including Lifetime Drift	$V_{\text{QE_LTD}}$	$V_{\text{IOUT(Q)}}$, $I_{\text{P}} = 0 \text{ A}$, $T_A = 25^\circ\text{C}$ to 150°C	-14	-10	-	10	14	mV
		$V_{\text{IOUT(Q)}}$, $I_{\text{P}} = 0 \text{ A}$, $T_A = -40^\circ\text{C}$ to 25°C	-10	-7	-	7	10	mV

[1] Absolute Min. and Absolute Max are the production limits in which the device will not exceed.

[2] -3 σ and +3 σ are mean $\pm 3\sigma$ values and are determined such that 99.73% of devices lie within the interval during initial characterization.

[3] Lifetime drift characteristics are based on a statistical combination of production distributions and worst case distribution of parametric drift of individuals observed during AEC-Q100 qualification.

ACS37002LMABTR-050U5-M

ACS37002LMABTR-050U5-M Gain_Sel Pin Performance Key

				Selection Identifier	
Parameter (Units)	Gain_Sel_1 (Boolean)	Gain_Sel_0 (Boolean)	Sens (mV/A)	Max IP (A)	
Type	Digital Input	Digital Input	Calculation	Unidirectional	
Selection Combination	0	0	80	50	
	0	1	100	40	
	1	0	120	33.3	
	1	1	60	66.7	

ACS37002LMABTR-050U5-M PERFORMANCE CHARACTERISTICS: Valid through full operating temperature range, $T_A = -40^\circ\text{C}$ to 150°C , $C_{\text{BYPASS}} = 0.1 \mu\text{F}$, and $V_{\text{CC}} = 5 \text{ V}$, unless otherwise specified

Characteristic	Symbol	Test Conditions	Minimum		Typ.	Maximum		Units
			Absolute Min. ^[1]	-3σ ^[2]		$+3\sigma$ ^[2]	Absolute Max. ^[1]	
NOMINAL PERFORMANCE								
Current Sensing Range	I_{PR}	Gain Sel 00	0	–	–	–	50	A
		Gain Sel 01	0	–	–	–	40	A
		Gain Sel 10	0	–	–	–	33.3	A
		Gain Sel 11	0	–	–	–	66.7	A
Sensitivity	Sens	Gain Sel 00; $I_{\text{PR}(\text{min})} < I_{\text{P}} < I_{\text{PR}(\text{max})}$	–	–	80	–	–	mV/A
		Gain Sel 01; $I_{\text{PR}(\text{min})} < I_{\text{P}} < I_{\text{PR}(\text{max})}$	–	–	100	–	–	mV/A
		Gain Sel 10; $I_{\text{PR}(\text{min})} < I_{\text{P}} < I_{\text{PR}(\text{max})}$	–	–	120	–	–	mV/A
		Gain Sel 11; $I_{\text{PR}(\text{min})} < I_{\text{P}} < I_{\text{PR}(\text{max})}$	–	–	60	–	–	mV/A
Overcurrent Fault Operating Range	$I_{\text{OCF-OR}}$	Typ. = factory-programmed default, FS = Full-Scale	25	–	50	–	100	%FS
Zero Current Output Voltage	$V_{\text{IOUT(Q)}}$	Unidirectional; $I_{\text{P}} = 0 \text{ A}$, $T_A = 25^\circ\text{C}$	–	–	0.5	–	–	V
TOTAL ERROR ($V_{\text{IOUT(ACTUAL)}} - (\text{Sens}_{\text{IDEAL}} \times I_{\text{PR}} + V_{\text{REF}}) / (\text{Sens}_{\text{IDEAL}} \times I_{\text{PR}}) \times 100$) AND TOTAL ERROR COMPONENTS								
Total Error	E_{TOT}	$I_{\text{P}} = I_{\text{PR}(\text{max})}$	–1.75	–1.1	–	1.1	1.75	%
Sensitivity Error	E_{SENS}	$I_{\text{P}} = I_{\text{PR}(\text{max})}$, $T_A = 25^\circ\text{C}$ to 150°C or -40°C to 25°C	–1.5	–1.1	–	1.1	1.5	%
Zero Current Reference Error	V_{RE}	$V_{\text{REFactual}} - V_{\text{REFideal}}$, $I_{\text{P}} = 0 \text{ A}$, $T_A = 25^\circ\text{C}$ to 150°C	–10	–5	–	5	10	mV
		$V_{\text{REFactual}} - V_{\text{REFideal}}$, $I_{\text{P}} = 0 \text{ A}$, $T_A = -40^\circ\text{C}$ to 25°C	–10	–4	–	4	10	mV
Offset Error	V_{OE}	$V_{\text{IOUT(Q)}} - V_{\text{REF}}$, $I_{\text{P}} = 0 \text{ A}$, $T_A = 25^\circ\text{C}$ to 150°C	–8	–5	–	5	8	mV
		$V_{\text{IOUT(Q)}} - V_{\text{REF}}$, $I_{\text{P}} = 0 \text{ A}$, $T_A = -40^\circ\text{C}$ to 25°C	–8	–4	–	4	8	mV
QVO Error	V_{QE}	$V_{\text{IOUT(Q)}}$, $I_{\text{P}} = 0 \text{ A}$, $T_A = 25^\circ\text{C}$ to 150°C	–10	–8	–	8	10	mV
		$V_{\text{IOUT(Q)}}$, $I_{\text{P}} = 0 \text{ A}$, $T_A = -40^\circ\text{C}$ to 25°C	–10	–5	–	5	10	mV
TOTAL ERROR AND TOTAL ERROR COMPONENTS INCLUDING LIFETIME DRIFT^[1, 2]								
Total Error Including Lifetime Drift	$E_{\text{TOT_LTD}}$	$I_{\text{P}} = I_{\text{PR}(\text{max})}$	–3.6	–2.8	–	2.8	3.6	%
Sensitivity Error Including Lifetime Drift	$E_{\text{SENS_LTD}}$	$I_{\text{P}} = I_{\text{PR}(\text{max})}$, $T_A = 25^\circ\text{C}$ to 150°C or -40°C to 25°C	–3.4	–2.6	–	2.6	3.4	%
Zero Current Reference Error Including Lifetime Drift	$V_{\text{RE_LTD}}$	$V_{\text{REFactual}} - V_{\text{REFideal}}$, $I_{\text{P}} = 0 \text{ A}$, $T_A = 25^\circ\text{C}$ to 150°C	–10	–7	–	7	10	mV
		$V_{\text{REFactual}} - V_{\text{REFideal}}$, $I_{\text{P}} = 0 \text{ A}$, $T_A = -40^\circ\text{C}$ to 25°C	–10	–5	–	5	10	mV
Offset Error Including Lifetime Drift	$V_{\text{OE_LTD}}$	$V_{\text{IOUT(Q)}} - V_{\text{REF}}$, $I_{\text{P}} = 0 \text{ A}$, $T_A = 25^\circ\text{C}$ to 150°C	–10	–7	–	7	10	mV
		$V_{\text{IOUT(Q)}} - V_{\text{REF}}$, $I_{\text{P}} = 0 \text{ A}$, $T_A = -40^\circ\text{C}$ to 25°C	–10	–4	–	4	10	mV
QVO Error Including Lifetime Drift	$V_{\text{QE_LTD}}$	$V_{\text{IOUT(Q)}}$, $I_{\text{P}} = 0 \text{ A}$, $T_A = 25^\circ\text{C}$ to 150°C	–14	–10	–	10	14	mV
		$V_{\text{IOUT(Q)}}$, $I_{\text{P}} = 0 \text{ A}$, $T_A = -40^\circ\text{C}$ to 25°C	–10	–7	–	7	10	mV

^[1] Absolute Min. and Absolute Max are the production limits in which the device will not exceed.

^[2] -3σ and $+3\sigma$ are mean $\pm 3\sigma$ values and are determined such that 99.73% of devices lie within the interval during initial characterization.

^[3] Lifetime drift characteristics are based on a statistical combination of production distributions and worst case distribution of parametric drift of individuals observed during AEC-Q100 qualification.

ACS37002LMABTR-066U5-M

ACS37002LMABTR-066U5-M Gain_Sel Pin Performance Key

				Selection Identifier	
Parameter (Units)	Gain_Sel_1 (Boolean)	Gain_Sel_0 (Boolean)	Sens (mV/A)	Max IP (A)	
Type	Digital Input	Digital Input	Calculation	Unidirectional	
Selection Combination	0	0	60	66.7	
	0	1	50	80	
	1	0	40	100	
	1	1	30	133.3	

ACS37002LMABTR-066U5-M PERFORMANCE CHARACTERISTICS: Valid through full operating temperature range, $T_A = -40^\circ\text{C}$ to 150°C , $C_{\text{BYPASS}} = 0.1 \mu\text{F}$, and $V_{\text{CC}} = 5 \text{V}$, unless otherwise specified

Characteristic	Symbol	Test Conditions	Minimum		Typ.	Maximum		Units
			Absolute Min. ^[1]	-3 σ ^[2]		+3 σ ^[2]	Absolute Max. ^[1]	
NOMINAL PERFORMANCE								
Current Sensing Range	I_{PR}	Gain Sel 00	0	-	-	-	66.7	A
		Gain Sel 01	0	-	-	-	80	A
		Gain Sel 10	0	-	-	-	100	A
		Gain Sel 11	0	-	-	-	133.3	A
Sensitivity	Sens	Gain Sel 00; $I_{\text{PR}(\text{min})} < I_{\text{P}} < I_{\text{PR}(\text{max})}$	-	-	60	-	-	mV/A
		Gain Sel 01; $I_{\text{PR}(\text{min})} < I_{\text{P}} < I_{\text{PR}(\text{max})}$	-	-	50	-	-	mV/A
		Gain Sel 10; $I_{\text{PR}(\text{min})} < I_{\text{P}} < I_{\text{PR}(\text{max})}$	-	-	40	-	-	mV/A
		Gain Sel 11; $I_{\text{PR}(\text{min})} < I_{\text{P}} < I_{\text{PR}(\text{max})}$	-	-	30	-	-	mV/A
Overcurrent Fault Operating Range	$I_{\text{OCF-OR}}$	Typ. = factory-programmed default, FS = Full-Scale	25	-	50	-	100	%FS
Zero Current Output Voltage	$V_{\text{IOUT(Q)}}$	Unidirectional; $I_{\text{P}} = 0 \text{A}$, $T_A = 25^\circ\text{C}$	-	-	0.5	-	-	V
TOTAL ERROR ($V_{\text{IOUT(ACTUAL)}} - (\text{Sens}_{\text{IDEAL}} \times I_{\text{PR}} + V_{\text{REF}}) / (\text{Sens}_{\text{IDEAL}} \times I_{\text{PR}}) \times 100$) AND TOTAL ERROR COMPONENTS								
Total Error	E_{TOT}	$I_{\text{P}} = I_{\text{PR}(\text{max})}$	-1.75	-1.1	-	1.1	1.75	%
Sensitivity Error	E_{SENS}	$I_{\text{P}} = I_{\text{PR}(\text{max})}$, $T_A = 25^\circ\text{C}$ to 150°C or -40°C to 25°C	-1.5	-1.1	-	1.1	1.5	%
Zero Current Reference Error	V_{RE}	$V_{\text{REFactual}} - V_{\text{REFideal}}$, $I_{\text{P}} = 0 \text{A}$, $T_A = 25^\circ\text{C}$ to 150°C	-10	-5	-	5	10	mV
		$V_{\text{REFactual}} - V_{\text{REFideal}}$, $I_{\text{P}} = 0 \text{A}$, $T_A = -40^\circ\text{C}$ to 25°C	-10	-4	-	4	10	mV
Offset Error	V_{OE}	$V_{\text{IOUT(Q)}} - V_{\text{REF}}$, $I_{\text{P}} = 0 \text{A}$, $T_A = 25^\circ\text{C}$ to 150°C	-8	-5	-	5	8	mV
		$V_{\text{IOUT(Q)}} - V_{\text{REF}}$, $I_{\text{P}} = 0 \text{A}$, $T_A = -40^\circ\text{C}$ to 25°C	-8	-4	-	4	8	mV
QVO Error	V_{QE}	$V_{\text{IOUT(Q)}}$, $I_{\text{P}} = 0 \text{A}$, $T_A = 25^\circ\text{C}$ to 150°C	-10	-8	-	8	10	mV
		$V_{\text{IOUT(Q)}}$, $I_{\text{P}} = 0 \text{A}$, $T_A = -40^\circ\text{C}$ to 25°C	-10	-5	-	5	10	mV
TOTAL ERROR AND TOTAL ERROR COMPONENTS INCLUDING LIFETIME DRIFT [1, 2]								
Total Error Including Lifetime Drift	$E_{\text{TOT_LTD}}$	$I_{\text{P}} = I_{\text{PR}(\text{max})}$	-3.6	-2.8	-	2.8	3.6	%
Sensitivity Error Including Lifetime Drift	$E_{\text{SENS_LTD}}$	$I_{\text{P}} = I_{\text{PR}(\text{max})}$, $T_A = 25^\circ\text{C}$ to 150°C or -40°C to 25°C	-3.4	-2.6	-	2.6	3.4	%
Zero Current Reference Error Including Lifetime Drift	$V_{\text{RE_LTD}}$	$V_{\text{REFactual}} - V_{\text{REFideal}}$, $I_{\text{P}} = 0 \text{A}$, $T_A = 25^\circ\text{C}$ to 150°C	-10	-7	-	7	10	mV
		$V_{\text{REFactual}} - V_{\text{REFideal}}$, $I_{\text{P}} = 0 \text{A}$, $T_A = -40^\circ\text{C}$ to 25°C	-10	-5	-	5	10	mV
Offset Error Including Lifetime Drift	$V_{\text{OE_LTD}}$	$V_{\text{IOUT(Q)}} - V_{\text{REF}}$, $I_{\text{P}} = 0 \text{A}$, $T_A = 25^\circ\text{C}$ to 150°C	-10	-7	-	7	10	mV
		$V_{\text{IOUT(Q)}} - V_{\text{REF}}$, $I_{\text{P}} = 0 \text{A}$, $T_A = -40^\circ\text{C}$ to 25°C	-10	-4	-	4	10	mV
QVO Error Including Lifetime Drift	$V_{\text{QE_LTD}}$	$V_{\text{IOUT(Q)}}$, $I_{\text{P}} = 0 \text{A}$, $T_A = 25^\circ\text{C}$ to 150°C	-14	-10	-	10	14	mV
		$V_{\text{IOUT(Q)}}$, $I_{\text{P}} = 0 \text{A}$, $T_A = -40^\circ\text{C}$ to 25°C	-10	-7	-	7	10	mV

[1] Absolute Min. and Absolute Max are the production limits in which the device will not exceed.

[2] -3 σ and +3 σ are mean $\pm 3\sigma$ values and are determined such that 99.73% of devices lie within the interval during initial characterization.

[3] Lifetime drift characteristics are based on a statistical combination of production distributions and worst case distribution of parametric drift of individuals observed during AEC-Q100 qualification.

ACS37002LMABTR-050B3

ACS37002LMABTR-050B3 Gain_Sel Pin Performance Key

				Selection Identifier	
Parameter (Units)	Gain_Sel_1 (Boolean)	Gain_Sel_0 (Boolean)	Sens (mV/A)	Max IP (A)	
Type	Digital Input	Digital Input	Calculation	Bidirectional	
Selection Combination	0	0	26.4	50	
	0	1	33	40	
	1	0	39.6	33.3	
	1	1	19.8	66.7	

ACS37002LMABTR-050B3 PERFORMANCE CHARACTERISTICS: Valid through full operating temperature range, $T_A = -40^\circ\text{C}$ to 150°C , $C_{\text{BYPASS}} = 0.1 \mu\text{F}$, and $V_{\text{CC}} = 3.3 \text{ V}$, unless otherwise specified

Characteristic	Symbol	Test Conditions	Minimum		Typ.	Maximum		Units
			Absolute Min. ^[1]	-3 σ ^[2]		+3 σ ^[2]	Absolute Max. ^[1]	
NOMINAL PERFORMANCE								
Current Sensing Range	I_{PR}	Gain Sel 00	-50	-	-	-	50	A
		Gain Sel 01	-40	-	-	-	40	A
		Gain Sel 10	-33.3	-	-	-	33.3	A
		Gain Sel 11	-66.7	-	-	-	66.7	A
Sensitivity	Sens	Gain Sel 00; $I_{\text{PR}(\text{min})} < I_{\text{P}} < I_{\text{PR}(\text{max})}$	-	-	26.4	-	-	mV/A
		Gain Sel 01; $I_{\text{PR}(\text{min})} < I_{\text{P}} < I_{\text{PR}(\text{max})}$	-	-	33	-	-	mV/A
		Gain Sel 10; $I_{\text{PR}(\text{min})} < I_{\text{P}} < I_{\text{PR}(\text{max})}$	-	-	39.6	-	-	mV/A
		Gain Sel 11; $I_{\text{PR}(\text{min})} < I_{\text{P}} < I_{\text{PR}(\text{max})}$	-	-	19.8	-	-	mV/A
Overcurrent Fault Operating Range	$I_{\text{OCF-OR}}$	Typ. = factory-programmed default, FS = Full-Scale	50	-	100	-	200	%FS
Zero Current Output Voltage	$V_{\text{IOUT(Q)}}$	Bidirectional; $I_{\text{P}} = 0 \text{ A}$, $T_A = 25^\circ\text{C}$	-	-	1.65	-	-	V
TOTAL ERROR ($V_{\text{IOUT(ACTUAL)}} - (\text{Sens}_{\text{IDEAL}} \times I_{\text{PR}} + V_{\text{REF}}) / (\text{Sens}_{\text{IDEAL}} \times I_{\text{PR}}) \times 100$) AND TOTAL ERROR COMPONENTS								
Total Error	E_{TOT}	$I_{\text{P}} = I_{\text{PR}(\text{max})}$	-1.75	-1.1	-	1.1	1.75	%
Sensitivity Error	E_{SENS}	$I_{\text{P}} = I_{\text{PR}(\text{max})}$, $T_A = 25^\circ\text{C}$ to 150°C or -40°C to 25°C	-1.5	-1.1	-	1.1	1.5	%
Zero Current Reference Error	V_{RE}	$V_{\text{REFactual}} - V_{\text{REFideal}}$, $I_{\text{P}} = 0 \text{ A}$, $T_A = 25^\circ\text{C}$ to 150°C	-10	-5	-	5	10	mV
		$V_{\text{REFactual}} - V_{\text{REFideal}}$, $I_{\text{P}} = 0 \text{ A}$, $T_A = -40^\circ\text{C}$ to 25°C	-10	-4	-	4	10	mV
Offset Error	V_{OE}	$V_{\text{IOUT(Q)}} - V_{\text{REF}}$, $I_{\text{P}} = 0 \text{ A}$, $T_A = 25^\circ\text{C}$ to 150°C	-8	-5	-	5	8	mV
		$V_{\text{IOUT(Q)}} - V_{\text{REF}}$, $I_{\text{P}} = 0 \text{ A}$, $T_A = -40^\circ\text{C}$ to 25°C	-8	-4	-	4	8	mV
QVO Error	V_{QE}	$V_{\text{IOUT(Q)}}$, $I_{\text{P}} = 0 \text{ A}$, $T_A = 25^\circ\text{C}$ to 150°C	-10	-8	-	8	10	mV
		$V_{\text{IOUT(Q)}}$, $I_{\text{P}} = 0 \text{ A}$, $T_A = -40^\circ\text{C}$ to 25°C	-10	-5	-	5	10	mV
TOTAL ERROR AND TOTAL ERROR COMPONENTS INCLUDING LIFETIME DRIFT [1, 2]								
Total Error Including Lifetime Drift	$E_{\text{TOT_LTD}}$	$I_{\text{P}} = I_{\text{PR}(\text{max})}$	-3.6	-2.8	-	2.8	3.6	%
Sensitivity Error Including Lifetime Drift	$E_{\text{SENS_LTD}}$	$I_{\text{P}} = I_{\text{PR}(\text{max})}$, $T_A = 25^\circ\text{C}$ to 150°C or -40°C to 25°C	-3.4	-2.6	-	2.6	3.4	%
Zero Current Reference Error Including Lifetime Drift	$V_{\text{RE_LTD}}$	$V_{\text{REFactual}} - V_{\text{REFideal}}$, $I_{\text{P}} = 0 \text{ A}$, $T_A = 25^\circ\text{C}$ to 150°C	-10	-7	-	7	10	mV
		$V_{\text{REFactual}} - V_{\text{REFideal}}$, $I_{\text{P}} = 0 \text{ A}$, $T_A = -40^\circ\text{C}$ to 25°C	-10	-5	-	5	10	mV
Offset Error Including Lifetime Drift	$V_{\text{OE_LTD}}$	$V_{\text{IOUT(Q)}} - V_{\text{REF}}$, $I_{\text{P}} = 0 \text{ A}$, $T_A = 25^\circ\text{C}$ to 150°C	-10	-7	-	7	10	mV
		$V_{\text{IOUT(Q)}} - V_{\text{REF}}$, $I_{\text{P}} = 0 \text{ A}$, $T_A = -40^\circ\text{C}$ to 25°C	-10	-4	-	4	10	mV
QVO Error Including Lifetime Drift	$V_{\text{QE_LTD}}$	$V_{\text{IOUT(Q)}}$, $I_{\text{P}} = 0 \text{ A}$, $T_A = 25^\circ\text{C}$ to 150°C	-14	-10	-	10	14	mV
		$V_{\text{IOUT(Q)}}$, $I_{\text{P}} = 0 \text{ A}$, $T_A = -40^\circ\text{C}$ to 25°C	-10	-7	-	7	10	mV

[1] Absolute Min. and Absolute Max are the production limits in which the device will not exceed.

[2] -3 σ and +3 σ are mean $\pm 3\sigma$ values and are determined such that 99.73% of devices lie within the interval during initial characterization.

[3] Lifetime drift characteristics are based on a statistical combination of production distributions and worst case distribution of parametric drift of individuals observed during AEC-Q100 qualification.

ACS37002LMABTR-066B3

ACS37002LMABTR-066B3 Gain_Sel Pin Performance Key

				Selection Identifier	
Parameter (Units)	Gain_Sel_1 (Boolean)	Gain_Sel_0 (Boolean)	Sens (mV/A)	Max IP (A)	
Type	Digital Input	Digital Input	Calculation	Bidirectional	
Selection Combination	0	0	19.8	66.7	
	0	1	16.5	80	
	1	0	13.2	100	
	1	1	9.9	133.3	

ACS37002LMABTR-066B3 PERFORMANCE CHARACTERISTICS: Valid through full operating temperature range, $T_A = -40^\circ\text{C}$ to 150°C , $C_{\text{BYPASS}} = 0.1 \mu\text{F}$, and $V_{\text{CC}} = 3.3 \text{ V}$, unless otherwise specified

Characteristic	Symbol	Test Conditions	Minimum		Typ.	Maximum		Units
			Absolute Min. ^[1]	-3 σ ^[2]		+3 σ ^[2]	Absolute Max. ^[1]	
NOMINAL PERFORMANCE								
Current Sensing Range	I_{PR}	Gain Sel 00	-66.7		-	-	66.7	A
		Gain Sel 01	-80		-	-	80	A
		Gain Sel 10	-100		-	-	100	A
		Gain Sel 11	-133.3		-	-	133.3	A
Sensitivity	Sens	Gain Sel 00; $I_{\text{PR}(\text{min})} < I_{\text{P}} < I_{\text{PR}(\text{max})}$	-		19.8	-	-	mV/A
		Gain Sel 01; $I_{\text{PR}(\text{min})} < I_{\text{P}} < I_{\text{PR}(\text{max})}$	-		16.5	-	-	mV/A
		Gain Sel 10; $I_{\text{PR}(\text{min})} < I_{\text{P}} < I_{\text{PR}(\text{max})}$	-		13.2	-	-	mV/A
		Gain Sel 11; $I_{\text{PR}(\text{min})} < I_{\text{P}} < I_{\text{PR}(\text{max})}$	-		9.9	-	-	mV/A
Overcurrent Fault Operating Range	$I_{\text{OCF-OR}}$	Typ. = factory-programmed default, FS = Full-Scale	50		100	-	200	%FS
Zero Current Output Voltage	$V_{\text{IOUT(Q)}}$	Bidirectional; $I_{\text{P}} = 0 \text{ A}$, $T_A = 25^\circ\text{C}$	-		1.65	-	-	V
TOTAL ERROR ($V_{\text{IOUT(ACTUAL)}} - (\text{Sens}_{\text{IDEAL}} \times I_{\text{PR}} + V_{\text{REF}}) / (\text{Sens}_{\text{IDEAL}} \times I_{\text{PR}}) \times 100$) AND TOTAL ERROR COMPONENTS								
Total Error	E_{TOT}	$I_{\text{P}} = I_{\text{PR}(\text{max})}$	-1.75	-1.1	-	1.1	1.75	%
Sensitivity Error	E_{SENS}	$I_{\text{P}} = I_{\text{PR}(\text{max})}$, $T_A = 25^\circ\text{C}$ to 150°C or -40°C to 25°C	-1.5	-1.1	-	1.1	1.5	%
Zero Current Reference Error	V_{RE}	$V_{\text{REFactual}} - V_{\text{REFideal}}$, $I_{\text{P}} = 0 \text{ A}$, $T_A = 25^\circ\text{C}$ to 150°C	-10	-5	-	5	10	mV
		$V_{\text{REFactual}} - V_{\text{REFideal}}$, $I_{\text{P}} = 0 \text{ A}$, $T_A = -40^\circ\text{C}$ to 25°C	-10	-4	-	4	10	mV
Offset Error	V_{OE}	$V_{\text{IOUT(Q)}} - V_{\text{REF}}$, $I_{\text{P}} = 0 \text{ A}$, $T_A = 25^\circ\text{C}$ to 150°C	-8	-5	-	5	8	mV
		$V_{\text{IOUT(Q)}} - V_{\text{REF}}$, $I_{\text{P}} = 0 \text{ A}$, $T_A = -40^\circ\text{C}$ to 25°C	-8	-4	-	4	8	mV
QVO Error	V_{QE}	$V_{\text{IOUT(Q)}}$, $I_{\text{P}} = 0 \text{ A}$, $T_A = 25^\circ\text{C}$ to 150°C	-10	-8	-	8	10	mV
		$V_{\text{IOUT(Q)}}$, $I_{\text{P}} = 0 \text{ A}$, $T_A = -40^\circ\text{C}$ to 25°C	-10	-5	-	5	10	mV
TOTAL ERROR AND TOTAL ERROR COMPONENTS INCLUDING LIFETIME DRIFT^[1, 2]								
Total Error Including Lifetime Drift	$E_{\text{TOT_LTD}}$	$I_{\text{P}} = I_{\text{PR}(\text{max})}$	-3.6	-2.8	-	2.8	3.6	%
Sensitivity Error Including Lifetime Drift	$E_{\text{SENS_LTD}}$	$I_{\text{P}} = I_{\text{PR}(\text{max})}$, $T_A = 25^\circ\text{C}$ to 150°C or -40°C to 25°C	-3.4	-2.6	-	2.6	3.4	%
Zero Current Reference Error Including Lifetime Drift	$V_{\text{RE_LTD}}$	$V_{\text{REFactual}} - V_{\text{REFideal}}$, $I_{\text{P}} = 0 \text{ A}$, $T_A = 25^\circ\text{C}$ to 150°C	-10	-7	-	7	10	mV
		$V_{\text{REFactual}} - V_{\text{REFideal}}$, $I_{\text{P}} = 0 \text{ A}$, $T_A = -40^\circ\text{C}$ to 25°C	-10	-5	-	5	10	mV
Offset Error Including Lifetime Drift	$V_{\text{OE_LTD}}$	$V_{\text{IOUT(Q)}} - V_{\text{REF}}$, $I_{\text{P}} = 0 \text{ A}$, $T_A = 25^\circ\text{C}$ to 150°C	-10	-7	-	7	10	mV
		$V_{\text{IOUT(Q)}} - V_{\text{REF}}$, $I_{\text{P}} = 0 \text{ A}$, $T_A = -40^\circ\text{C}$ to 25°C	-10	-4	-	4	10	mV
QVO Error Including Lifetime Drift	$V_{\text{QE_LTD}}$	$V_{\text{IOUT(Q)}}$, $I_{\text{P}} = 0 \text{ A}$, $T_A = 25^\circ\text{C}$ to 150°C	-14	-10	-	10	14	mV
		$V_{\text{IOUT(Q)}}$, $I_{\text{P}} = 0 \text{ A}$, $T_A = -40^\circ\text{C}$ to 25°C	-10	-7	-	7	10	mV

^[1] Absolute Min. and Absolute Max are the production limits in which the device will not exceed.

^[2] -3 σ and +3 σ are mean $\pm 3\sigma$ values and are determined such that 99.73% of devices lie within the interval during initial characterization.

^[3] Lifetime drift characteristics are based on a statistical combination of production distributions and worst case distribution of parametric drift of individuals observed during AEC-Q100 qualification.

ACS37002LMABTR-050U3

ACS37002LMABTR-050U3 Gain_Sel Pin Performance Key

				Selection Identifier	
Parameter (Units)	Gain_Sel_1 (Boolean)	Gain_Sel_0 (Boolean)	Sens (mV/A)	Max IP (A)	
Type	Digital Input	Digital Input	Calculation	Unidirectional	
Selection Combination	0	0	52.8	50	
	0	1	66	40	
	1	0	79.2	33.3	
	1	1	39.6	66.7	

ACS37002LMABTR-050U3 PERFORMANCE CHARACTERISTICS: Valid through full operating temperature range, $T_A = -40^\circ\text{C}$ to 150°C , $C_{\text{BYPASS}} = 0.1 \mu\text{F}$, and $V_{\text{CC}} = 3.3 \text{ V}$, unless otherwise specified

Characteristic	Symbol	Test Conditions	Minimum		Typ.	Maximum		Units
			Absolute Min. ^[1]	-3σ ^[2]		$+3\sigma$ ^[2]	Absolute Max. ^[1]	
NOMINAL PERFORMANCE								
Current Sensing Range	I_{PR}	Gain Sel 00	0		–	–	50	A
		Gain Sel 01	0		–	–	40	A
		Gain Sel 10	0		–	–	33.3	A
		Gain Sel 11	0		–	–	66.7	A
Sensitivity	Sens	Gain Sel 00; $I_{\text{PR}(\text{min})} < I_{\text{P}} < I_{\text{PR}(\text{max})}$	–		52.8	–	–	mV/A
		Gain Sel 01; $I_{\text{PR}(\text{min})} < I_{\text{P}} < I_{\text{PR}(\text{max})}$	–		66	–	–	mV/A
		Gain Sel 10; $I_{\text{PR}(\text{min})} < I_{\text{P}} < I_{\text{PR}(\text{max})}$	–		79.2	–	–	mV/A
		Gain Sel 11; $I_{\text{PR}(\text{min})} < I_{\text{P}} < I_{\text{PR}(\text{max})}$	–		39.6	–	–	mV/A
Overcurrent Fault Operating Range	$I_{\text{OCF-OR}}$	Typ. = factory-programmed default, FS = Full-Scale	25		50	–	100	%FS
Zero Current Output Voltage	$V_{\text{IOUT(Q)}}$	Unidirectional; $I_{\text{P}} = 0 \text{ A}$, $T_A = 25^\circ\text{C}$	–		0.33	–	–	V
TOTAL ERROR ($V_{\text{IOUT(ACTUAL)}} - (\text{Sens}_{\text{IDEAL}} \times I_{\text{PR}} + V_{\text{REF}})) / (\text{Sens}_{\text{IDEAL}} \times I_{\text{PR}}) \times 100$ AND TOTAL ERROR COMPONENTS								
Total Error	E_{TOT}	$I_{\text{P}} = I_{\text{PR}(\text{max})}$	–1.75	–1.1	–	1.1	1.75	%
Sensitivity Error	E_{SENS}	$I_{\text{P}} = I_{\text{PR}(\text{max})}$, $T_A = 25^\circ\text{C}$ to 150°C or -40°C to 25°C	–1.5	–1.1	–	1.1	1.5	%
Zero Current Reference Error	V_{RE}	$V_{\text{REFactual}} - V_{\text{REFideal}}$, $I_{\text{P}} = 0 \text{ A}$, $T_A = 25^\circ\text{C}$ to 150°C	–10	–5	–	5	10	mV
		$V_{\text{REFactual}} - V_{\text{REFideal}}$, $I_{\text{P}} = 0 \text{ A}$, $T_A = -40^\circ\text{C}$ to 25°C	–10	–4	–	4	10	mV
Offset Error	V_{OE}	$V_{\text{IOUT(Q)}} - V_{\text{REF}}$, $I_{\text{P}} = 0 \text{ A}$, $T_A = 25^\circ\text{C}$ to 150°C	–8	–5	–	5	8	mV
		$V_{\text{IOUT(Q)}} - V_{\text{REF}}$, $I_{\text{P}} = 0 \text{ A}$, $T_A = -40^\circ\text{C}$ to 25°C	–8	–4	–	4	8	mV
QVO Error	V_{QE}	$V_{\text{IOUT(Q)}}$, $I_{\text{P}} = 0 \text{ A}$, $T_A = 25^\circ\text{C}$ to 150°C	–10	–8	–	8	10	mV
		$V_{\text{IOUT(Q)}}$, $I_{\text{P}} = 0 \text{ A}$, $T_A = -40^\circ\text{C}$ to 25°C	–10	–5	–	5	10	mV
TOTAL ERROR AND TOTAL ERROR COMPONENTS INCLUDING LIFETIME DRIFT ^[1, 2]								
Total Error Including Lifetime Drift	$E_{\text{TOT_LTD}}$	$I_{\text{P}} = I_{\text{PR}(\text{max})}$	–3.6	–2.8	–	2.8	3.6	%
Sensitivity Error Including Lifetime Drift	$E_{\text{SENS_LTD}}$	$I_{\text{P}} = I_{\text{PR}(\text{max})}$, $T_A = 25^\circ\text{C}$ to 150°C or -40°C to 25°C	–3.4	–2.6	–	2.6	3.4	%
Zero Current Reference Error Including Lifetime Drift	$V_{\text{RE_LTD}}$	$V_{\text{REFactual}} - V_{\text{REFideal}}$, $I_{\text{P}} = 0 \text{ A}$, $T_A = 25^\circ\text{C}$ to 150°C	–10	–7	–	7	10	mV
		$V_{\text{REFactual}} - V_{\text{REFideal}}$, $I_{\text{P}} = 0 \text{ A}$, $T_A = -40^\circ\text{C}$ to 25°C	–10	–5	–	5	10	mV
Offset Error Including Lifetime Drift	$V_{\text{OE_LTD}}$	$V_{\text{IOUT(Q)}} - V_{\text{REF}}$, $I_{\text{P}} = 0 \text{ A}$, $T_A = 25^\circ\text{C}$ to 150°C	–10	–7	–	7	10	mV
		$V_{\text{IOUT(Q)}} - V_{\text{REF}}$, $I_{\text{P}} = 0 \text{ A}$, $T_A = -40^\circ\text{C}$ to 25°C	–10	–4	–	4	10	mV
QVO Error Including Lifetime Drift	$V_{\text{QE_LTD}}$	$V_{\text{IOUT(Q)}}$, $I_{\text{P}} = 0 \text{ A}$, $T_A = 25^\circ\text{C}$ to 150°C	–14	–10	–	10	14	mV
		$V_{\text{IOUT(Q)}}$, $I_{\text{P}} = 0 \text{ A}$, $T_A = -40^\circ\text{C}$ to 25°C	–10	–7	–	7	10	mV

^[1] Absolute Min. and Absolute Max are the production limits in which the device will not exceed.

^[2] -3σ and $+3\sigma$ are mean $\pm 3\sigma$ values and are determined such that 99.73% of devices lie within the interval during initial characterization.

^[3] Lifetime drift characteristics are based on a statistical combination of production distributions and worst case distribution of parametric drift of individuals observed during AEC-Q100 qualification.

ACS37002LMABTR-066U3

ACS37002LMABTR-066U3 Gain_Sel Pin Performance Key

				Selection Identifier	
Parameter (Units)	Gain_Sel_1 (Boolean)	Gain_Sel_0 (Boolean)	Sens (mV/A)	Max IP (A)	
Type	Digital Input	Digital Input	Calculation	Unidirectional	
Selection Combination	0	0	39.6	66.7	
	0	1	33	80	
	1	0	26.4	100	
	1	1	19.8	133.3	

ACS37002LMABTR-066U3 PERFORMANCE CHARACTERISTICS: Valid through full operating temperature range, $T_A = -40^\circ\text{C}$ to 150°C , $C_{\text{BYPASS}} = 0.1 \mu\text{F}$, and $V_{\text{CC}} = 3.3 \text{ V}$, unless otherwise specified

Characteristic	Symbol	Test Conditions	Minimum		Typ.	Maximum		Units
			Absolute Min. ^[1]	-3σ ^[2]		$+3\sigma$ ^[2]	Absolute Max. ^[1]	
NOMINAL PERFORMANCE								
Current Sensing Range	I_{PR}	Gain Sel 00	0	–	–	–	66.7	A
		Gain Sel 01	0	–	–	–	80	A
		Gain Sel 10	0	–	–	–	100	A
		Gain Sel 11	0	–	–	–	133.3	A
Sensitivity	Sens	Gain Sel 00; $I_{\text{PR}(\text{min})} < I_{\text{P}} < I_{\text{PR}(\text{max})}$	–	–	39.6	–	–	mV/A
		Gain Sel 01; $I_{\text{PR}(\text{min})} < I_{\text{P}} < I_{\text{PR}(\text{max})}$	–	–	33	–	–	mV/A
		Gain Sel 10; $I_{\text{PR}(\text{min})} < I_{\text{P}} < I_{\text{PR}(\text{max})}$	–	–	26.4	–	–	mV/A
		Gain Sel 11; $I_{\text{PR}(\text{min})} < I_{\text{P}} < I_{\text{PR}(\text{max})}$	–	–	19.8	–	–	mV/A
Overcurrent Fault Operating Range	$I_{\text{OCF-OR}}$	Typ. = factory-programmed default, FS = Full-Scale	25	–	50	–	100	%FS
Zero Current Output Voltage	$V_{\text{IOUT(Q)}}$	Unidirectional; $I_{\text{P}} = 0 \text{ A}$, $T_A = 25^\circ\text{C}$	–	–	0.33	–	–	V
TOTAL ERROR ($V_{\text{IOUT(ACTUAL)}} - (\text{Sens}_{(\text{IDEAL})} \times I_{\text{PR}} + V_{\text{REF}})$) / ($\text{Sens}_{(\text{IDEAL})} \times I_{\text{PR}}) \times 100$ AND TOTAL ERROR COMPONENTS								
Total Error	E_{TOT}	$I_{\text{P}} = I_{\text{PR}(\text{max})}$	–1.75	–1.1	–	1.1	1.75	%
Sensitivity Error	E_{SENS}	$I_{\text{P}} = I_{\text{PR}(\text{max})}$, $T_A = 25^\circ\text{C}$ to 150°C or -40°C to 25°C	–1.5	–1.1	–	1.1	1.5	%
Zero Current Reference Error	V_{RE}	$V_{\text{REFactual}} - V_{\text{REFideal}}$, $I_{\text{P}} = 0 \text{ A}$, $T_A = 25^\circ\text{C}$ to 150°C	–10	–5	–	5	10	mV
		$V_{\text{REFactual}} - V_{\text{REFideal}}$, $I_{\text{P}} = 0 \text{ A}$, $T_A = -40^\circ\text{C}$ to 25°C	–10	–4	–	4	10	mV
Offset Error	V_{OE}	$V_{\text{IOUT(Q)}} - V_{\text{REF}}$, $I_{\text{P}} = 0 \text{ A}$, $T_A = 25^\circ\text{C}$ to 150°C	–8	–5	–	5	8	mV
		$V_{\text{IOUT(Q)}} - V_{\text{REF}}$, $I_{\text{P}} = 0 \text{ A}$, $T_A = -40^\circ\text{C}$ to 25°C	–8	–4	–	4	8	mV
QVO Error	V_{QE}	$V_{\text{IOUT(Q)}}$, $I_{\text{P}} = 0 \text{ A}$, $T_A = 25^\circ\text{C}$ to 150°C	–10	–8	–	8	10	mV
		$V_{\text{IOUT(Q)}}$, $I_{\text{P}} = 0 \text{ A}$, $T_A = -40^\circ\text{C}$ to 25°C	–10	–5	–	5	10	mV
TOTAL ERROR AND TOTAL ERROR COMPONENTS INCLUDING LIFETIME DRIFT^[1, 2]								
Total Error Including Lifetime Drift	$E_{\text{TOT_LTD}}$	$I_{\text{P}} = I_{\text{PR}(\text{max})}$	–3.6	–2.8	–	2.8	3.6	%
Sensitivity Error Including Lifetime Drift	$E_{\text{SENS_LTD}}$	$I_{\text{P}} = I_{\text{PR}(\text{max})}$, $T_A = 25^\circ\text{C}$ to 150°C or -40°C to 25°C	–3.4	–2.6	–	2.6	3.4	%
Zero Current Reference Error Including Lifetime Drift	$V_{\text{RE_LTD}}$	$V_{\text{REFactual}} - V_{\text{REFideal}}$, $I_{\text{P}} = 0 \text{ A}$, $T_A = 25^\circ\text{C}$ to 150°C	–10	–7	–	7	10	mV
		$V_{\text{REFactual}} - V_{\text{REFideal}}$, $I_{\text{P}} = 0 \text{ A}$, $T_A = -40^\circ\text{C}$ to 25°C	–10	–5	–	5	10	mV
Offset Error Including Lifetime Drift	$V_{\text{OE_LTD}}$	$V_{\text{IOUT(Q)}} - V_{\text{REF}}$, $I_{\text{P}} = 0 \text{ A}$, $T_A = 25^\circ\text{C}$ to 150°C	–10	–7	–	7	10	mV
		$V_{\text{IOUT(Q)}} - V_{\text{REF}}$, $I_{\text{P}} = 0 \text{ A}$, $T_A = -40^\circ\text{C}$ to 25°C	–10	–4	–	4	10	mV
QVO Error Including Lifetime Drift	$V_{\text{QE_LTD}}$	$V_{\text{IOUT(Q)}}$, $I_{\text{P}} = 0 \text{ A}$, $T_A = 25^\circ\text{C}$ to 150°C	–14	–10	–	10	14	mV
		$V_{\text{IOUT(Q)}}$, $I_{\text{P}} = 0 \text{ A}$, $T_A = -40^\circ\text{C}$ to 25°C	–10	–7	–	7	10	mV

^[1] Absolute Min. and Absolute Max are the production limits in which the device will not exceed.

^[2] -3σ and $+3\sigma$ are mean $\pm 3\sigma$ values and are determined such that 99.73% of devices lie within the interval during initial characterization.

^[3] Lifetime drift characteristics are based on a statistical combination of production distributions and worst case distribution of parametric drift of individuals observed during AEC-Q100 qualification.

ACS37002KMABTR-050B5-M

AACS37002KMABTR-050B5-M Gain_Sel Pin Performance Key

				Selection Identifier	
Parameter (Units)	Gain_Sel_1 (Boolean)	Gain_Sel_0 (Boolean)	Sens (mV/A)	Max IP (A)	
Type	Digital Input	Digital Input	Calculation	Bidirectional	
Selection Combination	0	0	40	50	
	0	1	50	40	
	1	0	60	33.3	
	1	1	30	66.7	

ACS37002KMABTR-050B5-M PERFORMANCE CHARACTERISTICS: Valid through full operating temperature range, $T_A = -40^\circ\text{C}$ to 125°C , $C_{\text{BYPASS}} = 0.1 \mu\text{F}$, and $V_{\text{CC}} = 5 \text{V}$, unless otherwise specified

Characteristic	Symbol	Test Conditions	Minimum			Maximum			Units
			Absolute Min. ^[1]	-3 σ ^[2]	Typ.	+3 σ ^[2]	Absolute Max. ^[1]		
NOMINAL PERFORMANCE									
Current Sensing Range	I_{PR}	Gain Sel 00	-50	-	-	-	50	A	
		Gain Sel 01	-40	-	-	-	40	A	
		Gain Sel 10	-33.3	-	-	-	33.3	A	
		Gain Sel 11	-66.7	-	-	-	66.7	A	
Sensitivity	Sens	Gain Sel 00; $I_{\text{PR}(\text{min})} < I_{\text{P}} < I_{\text{PR}(\text{max})}$	-	-	40	-	-	mV/A	
		Gain Sel 01; $I_{\text{PR}(\text{min})} < I_{\text{P}} < I_{\text{PR}(\text{max})}$	-	-	50	-	-	mV/A	
		Gain Sel 10; $I_{\text{PR}(\text{min})} < I_{\text{P}} < I_{\text{PR}(\text{max})}$	-	-	60	-	-	mV/A	
		Gain Sel 11; $I_{\text{PR}(\text{min})} < I_{\text{P}} < I_{\text{PR}(\text{max})}$	-	-	30	-	-	mV/A	
Overcurrent Fault Operating Range	$I_{\text{OCF-OR}}$	Typ. = factory-programmed default, FS = Full-Scale	50	-	100	-	200	%FS	
Zero Current Output Voltage	$V_{\text{IOUT}(Q)}$	Bidirectional; $I_{\text{P}} = 0 \text{A}$, $T_A = 25^\circ\text{C}$	-	-	2.5	-	-	V	
TOTAL ERROR ($V_{\text{IOUT}(\text{ACTUAL})} - (\text{Sens}_{\text{IDEAL}} \times I_{\text{PR}} + V_{\text{REF}})$) / ($\text{Sens}_{\text{IDEAL}} \times I_{\text{PR}} \times 100$) AND TOTAL ERROR COMPONENTS									
Total Error	E_{TOT}	$I_{\text{P}} = I_{\text{PR}(\text{max})}$	-1.75	-1.1	-	1.1	1.75	%	
Sensitivity Error	E_{SENS}	$I_{\text{P}} = I_{\text{PR}(\text{max})}$, $T_A = 25^\circ\text{C}$ to 125°C , $T_A = -40^\circ\text{C}$ to 25°C	-1	-1.1	-	1.1	1	%	
Zero Current Reference Error	V_{RE}	$V_{\text{REFactual}} - V_{\text{REFideal}}$, $I_{\text{P}} = 0 \text{A}$, $T_A = 25^\circ\text{C}$ to 125°C	-10	-5	-	5	10	mV	
		$V_{\text{REFactual}} - V_{\text{REFideal}}$, $I_{\text{P}} = 0 \text{A}$, $T_A = -40^\circ\text{C}$ to 25°C	-10	-4	-	4	10	mV	
Offset Error	V_{OE}	$V_{\text{IOUT}(Q)} - V_{\text{REF}}$, $I_{\text{P}} = 0 \text{A}$, $T_A = 25^\circ\text{C}$ to 125°C	-8	-5	-	5	8	mV	
		$V_{\text{IOUT}(Q)} - V_{\text{REF}}$, $I_{\text{P}} = 0 \text{A}$, $T_A = -40^\circ\text{C}$ to 25°C	-8	-4	-	4	8	mV	
QVO Error	V_{QE}	$V_{\text{IOUT}(Q)}$, $I_{\text{P}} = 0 \text{A}$, $T_A = 25^\circ\text{C}$ to 125°C	-10	-8	-	8	10	mV	
		$V_{\text{IOUT}(Q)}$, $I_{\text{P}} = 0 \text{A}$, $T_A = -40^\circ\text{C}$ to 25°C	-10	-5	-	5	10	mV	
TOTAL ERROR AND TOTAL ERROR COMPONENTS INCLUDING LIFETIME DRIFT [1, 2]									
Total Error Including Lifetime Drift	$E_{\text{TOT_LTD}}$	$I_{\text{P}} = I_{\text{PR}(\text{max})}$	-3.4	-2.8	-	2.8	3.4	%	
Sensitivity Error Including Lifetime Drift	$E_{\text{SENS_LTD}}$	$I_{\text{P}} = I_{\text{PR}(\text{max})}$, $T_A = 25^\circ\text{C}$ to 125°C or -40°C to 25°C	-3.2	-2.6	-	2.6	3.2	%	
Zero Current Reference Error Including Lifetime Drift	$V_{\text{RE_LTD}}$	$V_{\text{REFactual}} - V_{\text{REFideal}}$, $I_{\text{P}} = 0 \text{A}$, $T_A = 25^\circ\text{C}$ to 125°C	-10	-7	-	7	10	mV	
		$V_{\text{REFactual}} - V_{\text{REFideal}}$, $I_{\text{P}} = 0 \text{A}$, $T_A = -40^\circ\text{C}$ to 25°C	-10	-5	-	5	10	mV	
Offset Error Including Lifetime Drift	$V_{\text{OE_LTD}}$	$V_{\text{IOUT}(Q)} - V_{\text{REF}}$, $I_{\text{P}} = 0 \text{A}$, $T_A = 25^\circ\text{C}$ to 125°C	-10	-7	-	7	10	mV	
		$V_{\text{IOUT}(Q)} - V_{\text{REF}}$, $I_{\text{P}} = 0 \text{A}$, $T_A = -40^\circ\text{C}$ to 25°C	-10	-4	-	4	10	mV	
QVO Error Including Lifetime Drift	$V_{\text{QE_LTD}}$	$V_{\text{IOUT}(Q)}$, $I_{\text{P}} = 0 \text{A}$, $T_A = 25^\circ\text{C}$ to 125°C	-14	-10	-	10	14	mV	
		$V_{\text{IOUT}(Q)}$, $I_{\text{P}} = 0 \text{A}$, $T_A = -40^\circ\text{C}$ to 25°C	-10	-7	-	7	10	mV	

[1] Absolute Min. and Absolute Max are the production limits in which the device will not exceed.

[2] -3 σ and +3 σ are mean $\pm 3\sigma$ values and are determined such that 99.73% of devices lie within the interval during initial characterization.

[3] Lifetime drift characteristics are based on a statistical combination of production distributions and worst case distribution of parametric drift of individuals observed during AEC-Q100 qualification.

ACS37002KMABTR-050B3

ACS37002KMABTR-050B3 Gain_Sel Pin Performance Key

				Selection Identifier
Parameter (Units)	Gain_Sel_1 (Boolean)	Gain_Sel_0 (Boolean)	Sens (mV/A)	Max IP (A)
Type	Digital Input	Digital Input	Calculation	Bidirectional
Selection Combination	0	0	26.4	50
	0	1	33	40
	1	0	39.6	33.3
	1	1	19.8	66.7

ACS37002KMABTR-050B3 PERFORMANCE CHARACTERISTICS: Valid through full operating temperature range, $T_A = -40^\circ\text{C}$ to 125°C , $C_{\text{BYPASS}} = 0.1 \mu\text{F}$, and $V_{\text{CC}} = 3.3 \text{ V}$, unless otherwise specified

Characteristic	Symbol	Test Conditions	Minimum		Typ.	Maximum		Units
			Absolute Min. ^[1]	-3 σ ^[2]		+3 σ ^[2]	Absolute Max. ^[1]	
NOMINAL PERFORMANCE								
Current Sensing Range	I_{PR}	Gain Sel 00	-50	-	-	-	50	A
		Gain Sel 01	-40	-	-	-	40	A
		Gain Sel 10	-33.3	-	-	-	33.3	A
		Gain Sel 11	-66.7	-	-	-	66.7	A
Sensitivity	Sens	Gain Sel 00; $I_{\text{PR}(\text{min})} < I_{\text{P}} < I_{\text{PR}(\text{max})}$	-	-	26.4	-	-	mV/A
		Gain Sel 01; $I_{\text{PR}(\text{min})} < I_{\text{P}} < I_{\text{PR}(\text{max})}$	-	-	33	-	-	mV/A
		Gain Sel 10; $I_{\text{PR}(\text{min})} < I_{\text{P}} < I_{\text{PR}(\text{max})}$	-	-	39.6	-	-	mV/A
		Gain Sel 11; $I_{\text{PR}(\text{min})} < I_{\text{P}} < I_{\text{PR}(\text{max})}$	-	-	19.8	-	-	mV/A
Overcurrent Fault Operating Range	$I_{\text{OCF-OR}}$	Typ. = factory-programmed default, FS = Full-Scale	50	-	100	-	200	%FS
Zero Current Output Voltage	$V_{\text{IOUT(Q)}}$	Bidirectional; $I_{\text{P}} = 0 \text{ A}$, $T_A = 25^\circ\text{C}$	-	-	1.65	-	-	V
TOTAL ERROR ($V_{\text{IOUT(ACTUAL)}} - (\text{Sens}_{(\text{IDEAL})} \times I_{\text{PR}} + V_{\text{REF}})$) / ($\text{Sens}_{(\text{IDEAL})} \times I_{\text{PR}}$) × 100 AND TOTAL ERROR COMPONENTS								
Total Error	E_{TOT}	$I_{\text{P}} = I_{\text{PR}(\text{max})}$	-1.75	-1.1	-	1.1	1.75	%
Sensitivity Error	E_{SENS}	$I_{\text{P}} = I_{\text{PR}(\text{max})}$, $T_A = 25^\circ\text{C}$ to 125°C , $T_A = -40^\circ\text{C}$ to 25°C	-1	-1.1	-	1.1	1	%
Zero Current Reference Error	V_{RE}	$V_{\text{REFactual}} - V_{\text{REFideal}}$, $I_{\text{P}} = 0 \text{ A}$, $T_A = 25^\circ\text{C}$ to 125°C	-10	-5	-	5	10	mV
		$V_{\text{REFactual}} - V_{\text{REFideal}}$, $I_{\text{P}} = 0 \text{ A}$, $T_A = -40^\circ\text{C}$ to 25°C	-10	-4	-	4	10	mV
Offset Error	V_{OE}	$V_{\text{IOUT(Q)}} - V_{\text{REF}}$, $I_{\text{P}} = 0 \text{ A}$, $T_A = 25^\circ\text{C}$ to 125°C	-8	-5	-	5	8	mV
		$V_{\text{IOUT(Q)}} - V_{\text{REF}}$, $I_{\text{P}} = 0 \text{ A}$, $T_A = -40^\circ\text{C}$ to 25°C	-8	-4	-	4	8	mV
QVO Error	V_{QE}	$V_{\text{IOUT(Q)}}$, $I_{\text{P}} = 0 \text{ A}$, $T_A = 25^\circ\text{C}$ to 125°C	-10	-8	-	8	10	mV
		$V_{\text{IOUT(Q)}}$, $I_{\text{P}} = 0 \text{ A}$, $T_A = -40^\circ\text{C}$ to 25°C	-10	-5	-	5	10	mV
TOTAL ERROR AND TOTAL ERROR COMPONENTS INCLUDING LIFETIME DRIFT ^[1]								
Total Error Including Lifetime Drift	$E_{\text{TOT_LTD}}$	$I_{\text{P}} = I_{\text{PR}(\text{max})}$	-3.4	-2.8	-	2.8	3.4	%
Sensitivity Error Including Lifetime Drift	$E_{\text{SENS_LTD}}$	$I_{\text{P}} = I_{\text{PR}(\text{max})}$, $T_A = 25^\circ\text{C}$ to 125°C or -40°C to 25°C	-3.2	-2.6	-	2.6	3.2	%
Zero Current Reference Error Including Lifetime Drift	$V_{\text{RE_LTD}}$	$V_{\text{REFactual}} - V_{\text{REFideal}}$, $I_{\text{P}} = 0 \text{ A}$, $T_A = 25^\circ\text{C}$ to 125°C	-10	-7	-	7	10	mV
		$V_{\text{REFactual}} - V_{\text{REFideal}}$, $I_{\text{P}} = 0 \text{ A}$, $T_A = -40^\circ\text{C}$ to 25°C	-10	-5	-	5	10	mV
Offset Error Including Lifetime Drift	$V_{\text{OE_LTD}}$	$V_{\text{IOUT(Q)}} - V_{\text{REF}}$, $I_{\text{P}} = 0 \text{ A}$, $T_A = 25^\circ\text{C}$ to 125°C	-10	-7	-	7	10	mV
		$V_{\text{IOUT(Q)}} - V_{\text{REF}}$, $I_{\text{P}} = 0 \text{ A}$, $T_A = -40^\circ\text{C}$ to 25°C	-10	-4	-	4	10	mV
QVO Error Including Lifetime Drift	$V_{\text{QE_LTD}}$	$V_{\text{IOUT(Q)}}$, $I_{\text{P}} = 0 \text{ A}$, $T_A = 25^\circ\text{C}$ to 125°C	-14	-10	-	10	14	mV
		$V_{\text{IOUT(Q)}}$, $I_{\text{P}} = 0 \text{ A}$, $T_A = -40^\circ\text{C}$ to 25°C	-10	-7	-	7	10	mV

^[1] Absolute Min. and Absolute Max are the production limits in which the device will not exceed.

^[2] -3 σ and +3 σ are mean $\pm 3\sigma$ values and are determined such that 99.73% of devices lie within the interval during initial characterization.

^[3] Lifetime drift characteristics are based on a statistical combination of production distributions and worst case distribution of parametric drift of individuals observed during AEC-Q100 qualification.

ACS37002LLAATR-015B5

ACS37002LLAATR-015B5 Gain_Sel Pin Performance Key

				Selection Identifier
Parameter (Units)	Gain_Sel_1 (Boolean)	Gain_Sel_0 (Boolean)	Sens (mV/A)	Max IP (A)
Type	Digital Input	Digital Input	Calculation	Bidirectional
Selection Combination	0	0	133.3	15
	0	1	166.6	12
	1	0	200	10
	1	1	100	20

ACS37002LLAATR-015B5 PERFORMANCE CHARACTERISTICS: Valid through full operating temperature range, $T_A = -40^\circ\text{C}$ to 150°C , $C_{\text{BYPASS}} = 0.1 \mu\text{F}$, and $V_{\text{CC}} = 5 \text{V}$, unless otherwise specified

Characteristic	Symbol	Test Conditions	Minimum		Typ.	Maximum		Units
			Absolute Min. ^[1]	-3 σ ^[2]		+3 σ ^[2]	Absolute Max. ^[1]	
NOMINAL PERFORMANCE								
Current Sensing Range	I_{PR}	Gain Sel 00	-15	-	-	-	15	A
		Gain Sel 01	-12	-	-	-	12	A
		Gain Sel 10	-10	-	-	-	10	A
		Gain Sel 11	-20	-	-	-	20	A
Sensitivity	Sens	Gain Sel 00; $I_{\text{PR}(\text{min})} < I_{\text{P}} < I_{\text{PR}(\text{max})}$	-	-	133.3	-	-	mV/A
		Gain Sel 01; $I_{\text{PR}(\text{min})} < I_{\text{P}} < I_{\text{PR}(\text{max})}$	-	-	166.6	-	-	mV/A
		Gain Sel 10; $I_{\text{PR}(\text{min})} < I_{\text{P}} < I_{\text{PR}(\text{max})}$	-	-	200	-	-	mV/A
		Gain Sel 11; $I_{\text{PR}(\text{min})} < I_{\text{P}} < I_{\text{PR}(\text{max})}$	-	-	100	-	-	mV/A
Overcurrent Fault Operating Range	$I_{\text{OCF-OR}}$	Typ. = factory-programmed default, FS = Full-Scale	50	-	100	-	200	%FS
Zero Current Output Voltage	$V_{\text{IOUT(Q)}}$	Bidirectional; $I_{\text{P}} = 0 \text{A}$, $T_A = 25^\circ\text{C}$	-	-	2.5	-	-	V
TOTAL ERROR ($V_{\text{IOUT(ACTUAL)}} - (\text{Sens}_{(\text{IDEAL})} \times I_{\text{PR}} + V_{\text{REF}})$) / ($\text{Sens}_{(\text{IDEAL})} \times I_{\text{PR}}) \times 100$ AND TOTAL ERROR COMPONENTS								
Total Error	E_{TOT}	$I_{\text{P}} = I_{\text{PR}(\text{max})}$, $T_A = 25^\circ\text{C}$ to 150°C	-1.75	-1.2	-	1.2	1.75	%
		$I_{\text{P}} = I_{\text{PR}(\text{max})}$, $T_A = -40^\circ\text{C}$ to 25°C	-1.75	-1.4	-	1.4	1.75	%
Sensitivity Error	E_{SENS}	$I_{\text{P}} = I_{\text{PR}(\text{max})}$, $T_A = 25^\circ\text{C}$ to 150°C , $T_A = -40^\circ\text{C}$ to 25°C	-1.5	-1.2	-	1.2	1.5	%
Zero Current Reference Error	V_{RE}	$V_{\text{REFactual}} - V_{\text{REFideal}}$, $I_{\text{P}} = 0 \text{A}$, $T_A = 25^\circ\text{C}$ to 150°C , $T_A = -40^\circ\text{C}$ to 25°C	-10	-3	-	3	10	mV
Offset Error	V_{OE}	$V_{\text{IOUT(Q)}} - V_{\text{REF}}$, $I_{\text{P}} = 0 \text{A}$, $T_A = 25^\circ\text{C}$ to 150°C , $T_A = -40^\circ\text{C}$ to 25°C	-8	-5	-	5	8	mV
QVO Error	V_{QE}	$V_{\text{IOUT(Q)}}$, $I_{\text{P}} = 0 \text{A}$, $T_A = 25^\circ\text{C}$ to 150°C , $T_A = -40^\circ\text{C}$ to 25°C	-10	-5	-	5	10	mV
TOTAL ERROR AND TOTAL ERROR COMPONENTS INCLUDING LIFETIME DRIFT ^[1]								
Total Error Including Lifetime Drift	$E_{\text{TOT_LTD}}$	$I_{\text{P}} = I_{\text{PR}(\text{max})}$, $T_A = 25^\circ\text{C}$ to 150°C	-3.7	-2.5	-	2.5	3.7	%
		$I_{\text{P}} = I_{\text{PR}(\text{max})}$, $T_A = -40^\circ\text{C}$ to 25°C	-3.5	-2.4	-	2.4	3.5	%
Sensitivity Error Including Lifetime Drift	$E_{\text{SENS_LTD}}$	$I_{\text{P}} = I_{\text{PR}(\text{max})}$, $T_A = 25^\circ\text{C}$ to 150°C	-3.5	-2.4	-	2.4	3.5	%
		$I_{\text{P}} = I_{\text{PR}(\text{max})}$, $T_A = -40^\circ\text{C}$ to 25°C	-3.4	-2.3	-	2.3	3.4	%
Zero Current Reference Error Including Lifetime Drift	$V_{\text{RE_LTD}}$	$V_{\text{REFactual}} - V_{\text{REFideal}}$, $I_{\text{P}} = 0 \text{A}$, $T_A = 25^\circ\text{C}$ to 125°C , $T_A = -40^\circ\text{C}$ to 25°C	-11	-7	-	7	11	mV
Offset Error Including Lifetime Drift	$V_{\text{OE_LTD}}$	$V_{\text{IOUT(Q)}} - V_{\text{REF}}$, $I_{\text{P}} = 0 \text{A}$, $T_A = 25^\circ\text{C}$ to 125°C	-15	-9	-	9	15	mV
		$V_{\text{IOUT(Q)}} - V_{\text{REF}}$, $I_{\text{P}} = 0 \text{A}$, $T_A = -40^\circ\text{C}$ to 25°C	-11	-7	-	7	11	mV
QVO Error Including Lifetime Drift	$V_{\text{QE_LTD}}$	$V_{\text{IOUT(Q)}}$, $I_{\text{P}} = 0 \text{A}$, $T_A = 25^\circ\text{C}$ to 125°C	-17	-9	-	9	17	mV
		$V_{\text{IOUT(Q)}}$, $I_{\text{P}} = 0 \text{A}$, $T_A = -40^\circ\text{C}$ to 25°C	-14	-8	-	8	14	mV

^[1] Absolute Min. and Absolute Max are the production limits in which the device will not exceed.

^[2] -3 σ and +3 σ are mean $\pm 3\sigma$ values and are determined such that 99.73% of devices lie within the interval during initial characterization.

^[3] Lifetime drift characteristics are based on a statistical combination of production distributions and worst case distribution of parametric drift of individuals observed during AEC-Q100 qualification.

ACS37002LLAATR-025B5

ACS37002LLAATR-025B5 Gain_Sel Pin Performance Key

				Selection Identifier	
Parameter (Units)	Gain_Sel_1 (Boolean)	Gain_Sel_0 (Boolean)	Sens (mV/A)	Max IP (A)	
Type	Digital Input	Digital Input	Calculation	Bidirectional	
Selection Combination	0	0	80	25	
	0	1	66.6	30	
	1	0	53.3	37.5	
	1	1	40	50	

ACS37002LLAATR-025B5 PERFORMANCE CHARACTERISTICS: Valid through full operating temperature range, $T_A = -40^\circ\text{C}$ to 150°C , $C_{\text{BYPASS}} = 0.1 \mu\text{F}$, and $V_{\text{CC}} = 5 \text{ V}$, unless otherwise specified

Characteristic	Symbol	Test Conditions	Minimum		Typ.	Maximum		Units
			Absolute Min. ^[1]	-3σ ^[2]		$+3\sigma$ ^[2]	Absolute Max. ^[1]	
NOMINAL PERFORMANCE								
Current Sensing Range	I_{PR}	Gain Sel 00	-25		-	25	A	
		Gain Sel 01	-30		-	30	A	
		Gain Sel 10	-37.5		-	37.5	A	
		Gain Sel 11	-50		-	50	A	
Sensitivity	Sens	Gain Sel 00; $I_{\text{PR}(\text{min})} < I_{\text{P}} < I_{\text{PR}(\text{max})}$	-		80	-	mV/A	
		Gain Sel 01; $I_{\text{PR}(\text{min})} < I_{\text{P}} < I_{\text{PR}(\text{max})}$	-		66.6	-	mV/A	
		Gain Sel 10; $I_{\text{PR}(\text{min})} < I_{\text{P}} < I_{\text{PR}(\text{max})}$	-		53.3	-	mV/A	
		Gain Sel 11; $I_{\text{PR}(\text{min})} < I_{\text{P}} < I_{\text{PR}(\text{max})}$	-		40	-	mV/A	
Overcurrent Fault Operating Range	$I_{\text{OCF-OR}}$	Typ. = factory-programmed default, FS = Full-Scale	50		100	200	%FS	
Zero Current Output Voltage	$V_{\text{IOUT(Q)}}$	Bidirectional; $I_{\text{P}} = 0 \text{ A}$, $T_A = 25^\circ\text{C}$	-		2.5	-	V	
TOTAL ERROR ($V_{\text{IOUT(ACTUAL)}} - (\text{Sens}_{\text{IDEAL}} \times I_{\text{PR}} + V_{\text{REF}})) / (\text{Sens}_{\text{IDEAL}} \times I_{\text{PR}}) \times 100$) AND TOTAL ERROR COMPONENTS								
Total Error	E_{TOT}	$I_{\text{P}} = I_{\text{PR}(\text{max})}$, $T_A = 25^\circ\text{C}$ to 150°C	-1.75	-1.2	-	1.2	1.75	%
		$I_{\text{P}} = I_{\text{PR}(\text{max})}$, $T_A = -40^\circ\text{C}$ to 25°C	-1.75	-1.4	-	1.4	1.75	%
Sensitivity Error	E_{SENS}	$I_{\text{P}} = I_{\text{PR}(\text{max})}$, $T_A = 25^\circ\text{C}$ to 150°C , $T_A = -40^\circ\text{C}$ to 25°C	-1.5	-1.2	-	1.2	1.5	%
Zero Current Reference Error	V_{RE}	$V_{\text{REFACTUAL}} - V_{\text{REFIDEAL}}$, $I_{\text{P}} = 0 \text{ A}$, $T_A = 25^\circ\text{C}$ to 150°C , $T_A = -40^\circ\text{C}$ to 25°C	-10	-3	-	3	10	mV
Offset Error	V_{OE}	$V_{\text{IOUT(Q)}} - V_{\text{REF}}$, $I_{\text{P}} = 0 \text{ A}$, $T_A = 25^\circ\text{C}$ to 150°C , $T_A = -40^\circ\text{C}$ to 25°C	-8	-5	-	5	8	mV
QVO Error	V_{QE}	$V_{\text{IOUT(Q)}}$, $I_{\text{P}} = 0 \text{ A}$, $T_A = 25^\circ\text{C}$ to 150°C , $T_A = -40^\circ\text{C}$ to 25°C	-10	-5	-	5	10	mV
TOTAL ERROR AND TOTAL ERROR COMPONENTS INCLUDING LIFETIME DRIFT ^[1]								
Total Error Including Lifetime Drift	$E_{\text{TOT_LTD}}$	$I_{\text{P}} = I_{\text{PR}(\text{max})}$, $T_A = 25^\circ\text{C}$ to 150°C	-3.7	-2.5	-	2.5	3.7	%
		$I_{\text{P}} = I_{\text{PR}(\text{max})}$, $T_A = -40^\circ\text{C}$ to 25°C	-3.5	-2.4	-	2.4	3.5	%
Sensitivity Error Including Lifetime Drift	$E_{\text{SENS_LTD}}$	$I_{\text{P}} = I_{\text{PR}(\text{max})}$, $T_A = 25^\circ\text{C}$ to 150°C	-3.5	-2.4	-	2.4	3.5	%
		$I_{\text{P}} = I_{\text{PR}(\text{max})}$, $T_A = -40^\circ\text{C}$ to 25°C	-3.4	-2.3	-	2.3	3.4	%
Zero Current Reference Error Including Lifetime Drift	$V_{\text{RE_LTD}}$	$V_{\text{REFACTUAL}} - V_{\text{REFIDEAL}}$, $I_{\text{P}} = 0 \text{ A}$, $T_A = 25^\circ\text{C}$ to 125°C , $T_A = -40^\circ\text{C}$ to 25°C	-11	-7	-	7	11	mV
Offset Error Including Lifetime Drift	$V_{\text{OE_LTD}}$	$V_{\text{IOUT(Q)}} - V_{\text{REF}}$, $I_{\text{P}} = 0 \text{ A}$, $T_A = 25^\circ\text{C}$ to 125°C	-15	-9	-	9	15	mV
		$V_{\text{IOUT(Q)}} - V_{\text{REF}}$, $I_{\text{P}} = 0 \text{ A}$, $T_A = -40^\circ\text{C}$ to 25°C	-11	-7	-	7	11	mV
QVO Error Including Lifetime Drift	$V_{\text{QE_LTD}}$	$V_{\text{IOUT(Q)}}$, $I_{\text{P}} = 0 \text{ A}$, $T_A = 25^\circ\text{C}$ to 125°C	-17	-9	-	9	17	mV
		$V_{\text{IOUT(Q)}}$, $I_{\text{P}} = 0 \text{ A}$, $T_A = -40^\circ\text{C}$ to 25°C	-14	-8	-	8	14	mV

^[1] Absolute Min. and Absolute Max are the production limits in which the device will not exceed.

^[2] -3σ and $+3\sigma$ are mean $\pm 3\sigma$ values and are determined such that 99.73% of devices lie within the interval during initial characterization.

^[3] Lifetime drift characteristics are based on a statistical combination of production distributions and worst case distribution of parametric drift of individuals observed during AEC-Q100 qualification.

ACS37002LLAATR-015B3

ACS37002LLAATR-015B3 Gain_Sel Pin Performance Key

				Selection Identifier	
Parameter (Units)	Gain_Sel_1 (Boolean)	Gain_Sel_0 (Boolean)	Sens (mV/A)	Max IP (A)	
Type	Digital Input	Digital Input	Calculation	Bidirectional	
Selection Combination	0	0	88	15	
	0	1	110	12	
	1	0	132	10	
	1	1	66	20	

ACS37002LLAATR-015B3 PERFORMANCE CHARACTERISTICS: Valid through full operating temperature range, $T_A = -40^\circ\text{C}$ to 150°C , $C_{\text{BYPASS}} = 0.1 \mu\text{F}$, and $V_{\text{CC}} = 3.3 \text{ V}$, unless otherwise specified

Characteristic	Symbol	Test Conditions	Minimum		Typ.	Maximum		Units
			Absolute Min. ^[1]	-3σ ^[2]		$+3\sigma$ ^[2]	Absolute Max. ^[1]	
NOMINAL PERFORMANCE								
Current Sensing Range	I_{PR}	Gain Sel 00	-15	-	-	15	A	
		Gain Sel 01	-12	-	-	12	A	
		Gain Sel 10	-10	-	-	10	A	
		Gain Sel 11	-20	-	-	20	A	
Sensitivity	Sens	Gain Sel 00; $I_{\text{PR}(\text{min})} < I_{\text{P}} < I_{\text{PR}(\text{max})}$	-	-	88	-	mV/A	
		Gain Sel 01; $I_{\text{PR}(\text{min})} < I_{\text{P}} < I_{\text{PR}(\text{max})}$	-	-	110	-	mV/A	
		Gain Sel 10; $I_{\text{PR}(\text{min})} < I_{\text{P}} < I_{\text{PR}(\text{max})}$	-	-	132	-	mV/A	
		Gain Sel 11; $I_{\text{PR}(\text{min})} < I_{\text{P}} < I_{\text{PR}(\text{max})}$	-	-	66	-	mV/A	
Overcurrent Fault Operating Range	$I_{\text{OCF-OR}}$	Typ. = factory-programmed default, FS = Full-Scale	50	-	100	200	%FS	
Zero Current Output Voltage	$V_{\text{IOUT(Q)}}$	Bidirectional; $I_{\text{P}} = 0 \text{ A}$, $T_A = 25^\circ\text{C}$	-	-	1.65	-	V	
TOTAL ERROR ($V_{\text{IOUT(ACTUAL)}} - (\text{Sens}_{\text{IDEAL}} \times I_{\text{PR}} + V_{\text{REF}})$) / ($\text{Sens}_{\text{IDEAL}} \times I_{\text{PR}} \times 100$) AND TOTAL ERROR COMPONENTS								
Total Error	E_{TOT}	$I_{\text{P}} = I_{\text{PR}(\text{max})}$, $T_A = 25^\circ\text{C}$ to 150°C	-1.75	-1.2	-	1.2	1.75	%
		$I_{\text{P}} = I_{\text{PR}(\text{max})}$, $T_A = -40^\circ\text{C}$ to 25°C	-1.75	-1.4	-	1.4	1.75	%
Sensitivity Error	E_{SENS}	$I_{\text{P}} = I_{\text{PR}(\text{max})}$, $T_A = 25^\circ\text{C}$ to 150°C , $T_A = -40^\circ\text{C}$ to 25°C	-1.5	-1.2	-	1.2	1.5	%
Zero Current Reference Error	V_{RE}	$V_{\text{REFactual}} - V_{\text{REFideal}}$, $I_{\text{P}} = 0 \text{ A}$, $T_A = 25^\circ\text{C}$ to 150°C , $T_A = -40^\circ\text{C}$ to 25°C	-10	-3	-	3	10	mV
Offset Error	V_{OE}	$V_{\text{IOUT(Q)}} - V_{\text{REF}}$, $I_{\text{P}} = 0 \text{ A}$, $T_A = 25^\circ\text{C}$ to 150°C , $T_A = -40^\circ\text{C}$ to 25°C	-8	-5	-	5	8	mV
QVO Error	V_{QE}	$V_{\text{IOUT(Q)}}$, $I_{\text{P}} = 0 \text{ A}$, $T_A = 25^\circ\text{C}$ to 150°C , $T_A = -40^\circ\text{C}$ to 25°C	-10	-5	-	5	10	mV
TOTAL ERROR AND TOTAL ERROR COMPONENTS INCLUDING LIFETIME DRIFT ^{[2][3]}								
Total Error Including Lifetime Drift	$E_{\text{TOT_LTD}}$	$I_{\text{P}} = I_{\text{PR}(\text{max})}$, $T_A = 25^\circ\text{C}$ to 150°C	-3.7	-2.5	-	2.5	3.7	%
		$I_{\text{P}} = I_{\text{PR}(\text{max})}$, $T_A = -40^\circ\text{C}$ to 25°C	-3.5	-2.4	-	2.4	3.5	%
Sensitivity Error Including Lifetime Drift	$E_{\text{SENS_LTD}}$	$I_{\text{P}} = I_{\text{PR}(\text{max})}$, $T_A = 25^\circ\text{C}$ to 150°C	-3.5	-2.4	-	2.4	3.5	%
		$I_{\text{P}} = I_{\text{PR}(\text{max})}$, $T_A = -40^\circ\text{C}$ to 25°C	-3.4	-2.3	-	2.3	3.4	%
Zero Current Reference Error Including Lifetime Drift	$V_{\text{RE_LTD}}$	$V_{\text{REFactual}} - V_{\text{REFideal}}$, $I_{\text{P}} = 0 \text{ A}$, $T_A = 25^\circ\text{C}$ to 125°C , $T_A = -40^\circ\text{C}$ to 25°C	-11	-7	-	7	11	mV
Offset Error Including Lifetime Drift	$V_{\text{OE_LTD}}$	$V_{\text{IOUT(Q)}} - V_{\text{REF}}$, $I_{\text{P}} = 0 \text{ A}$, $T_A = 25^\circ\text{C}$ to 125°C	-15	-9	-	9	15	mV
		$V_{\text{IOUT(Q)}} - V_{\text{REF}}$, $I_{\text{P}} = 0 \text{ A}$, $T_A = -40^\circ\text{C}$ to 25°C	-11	-7	-	7	11	mV
QVO Error Including Lifetime Drift	$V_{\text{QE_LTD}}$	$V_{\text{IOUT(Q)}}$, $I_{\text{P}} = 0 \text{ A}$, $T_A = 25^\circ\text{C}$ to 125°C	-17	-9	-	9	17	mV
		$V_{\text{IOUT(Q)}}$, $I_{\text{P}} = 0 \text{ A}$, $T_A = -40^\circ\text{C}$ to 25°C	-14	-8	-	8	14	mV

^[1] Absolute Min. and Absolute Max are the production limits in which the device will not exceed.

^[2] -3σ and $+3\sigma$ are mean $\pm 3\sigma$ values and are determined such that 99.73% of devices lie within the interval during initial characterization.

^[3] Lifetime drift characteristics are based on a statistical combination of production distributions and worst case distribution of parametric drift of individuals observed during AEC-Q100 qualification.

ACS37002LLAATR-025U3

ACS37002LLAATR-025U3 Gain_Sel Pin Performance Key

				Selection Identifier
Parameter (Units)	Gain_Sel_1 (Boolean)	Gain_Sel_0 (Boolean)	Sens (mV/A)	Max IP (A)
Type	Digital Input	Digital Input	Calculation	Unidirectional
Selection Combination	0	0	105.6	25
	0	1	88	30
	1	0	70.4	37.5
	1	1	52.8	50

ACS37002LLAATR-025U3 PERFORMANCE CHARACTERISTICS: Valid through full operating temperature range, $T_A = -40^\circ\text{C}$ to 150°C , $C_{\text{BYPASS}} = 0.1 \mu\text{F}$, and $V_{\text{CC}} = 3.3 \text{ V}$, unless otherwise specified

Characteristic	Symbol	Test Conditions	Minimum		Typ.	Maximum		Units
			Absolute Min. ^[1]	-3 σ ^[2]		+3 σ ^[2]	Absolute Max. ^[1]	
NOMINAL PERFORMANCE								
Current Sensing Range	I_{PR}	Gain Sel 00	0	-	-	-	25	A
		Gain Sel 01	0	-	-	-	30	A
		Gain Sel 10	0	-	-	-	37.5	A
		Gain Sel 11	0	-	-	-	50	A
Sensitivity	Sens	Gain Sel 00; $I_{\text{PR}(\text{min})} < I_{\text{P}} < I_{\text{PR}(\text{max})}$	-	-	105.6	-	-	mV/A
		Gain Sel 01; $I_{\text{PR}(\text{min})} < I_{\text{P}} < I_{\text{PR}(\text{max})}$	-	-	88	-	-	mV/A
		Gain Sel 10; $I_{\text{PR}(\text{min})} < I_{\text{P}} < I_{\text{PR}(\text{max})}$	-	-	70.4	-	-	mV/A
		Gain Sel 11; $I_{\text{PR}(\text{min})} < I_{\text{P}} < I_{\text{PR}(\text{max})}$	-	-	52.8	-	-	mV/A
Overcurrent Fault Operating Range	$I_{\text{OCF-OR}}$	Typ. = factory-programmed default, FS = Full-Scale	25	-	50	-	100	%FS
Zero Current Output Voltage	$V_{\text{IOUT(Q)}}$	Unidirectional; $I_{\text{P}} = 0 \text{ A}$, $T_A = 25^\circ\text{C}$	-	-	0.33	-	-	V
TOTAL ERROR ($V_{\text{IOUT(ACTUAL)}} - (\text{Sens}_{(\text{IDEAL})} \times I_{\text{PR}} + V_{\text{REF}})$) / ($\text{Sens}_{(\text{IDEAL})} \times I_{\text{PR}}) \times 100$ AND TOTAL ERROR COMPONENTS								
Total Error	E_{TOT}	$I_{\text{P}} = I_{\text{PR}(\text{max})}$, $T_A = 25^\circ\text{C}$ to 150°C	-1.75	-1.2	-	1.2	1.75	%
		$I_{\text{P}} = I_{\text{PR}(\text{max})}$, $T_A = -40^\circ\text{C}$ to 25°C	-1.75	-1.4	-	1.4	1.75	%
Sensitivity Error	E_{SENS}	$I_{\text{P}} = I_{\text{PR}(\text{max})}$, $T_A = 25^\circ\text{C}$ to 150°C , $T_A = -40^\circ\text{C}$ to 25°C	-1.5	-1.2	-	1.2	1.5	%
Zero Current Reference Error	V_{RE}	$V_{\text{REFactual}} - V_{\text{REFideal}}$, $I_{\text{P}} = 0 \text{ A}$, $T_A = 25^\circ\text{C}$ to 150°C , $T_A = -40^\circ\text{C}$ to 25°C	-10	-3	-	3	10	mV
Offset Error	V_{OE}	$V_{\text{IOUT(Q)}} - V_{\text{REF}}$, $I_{\text{P}} = 0 \text{ A}$, $T_A = 25^\circ\text{C}$ to 150°C , $T_A = -40^\circ\text{C}$ to 25°C	-8	-5	-	5	8	mV
QVO Error	V_{QE}	$V_{\text{IOUT(Q)}}$, $I_{\text{P}} = 0 \text{ A}$, $T_A = 25^\circ\text{C}$ to 150°C , $T_A = -40^\circ\text{C}$ to 25°C	-10	-5	-	5	10	mV
TOTAL ERROR AND TOTAL ERROR COMPONENTS INCLUDING LIFETIME DRIFT ^{[2][3]}								
Total Error Including Lifetime Drift	$E_{\text{TOT_LTD}}$	$I_{\text{P}} = I_{\text{PR}(\text{max})}$, $T_A = 25^\circ\text{C}$ to 150°C	-3.7	-2.5	-	2.5	3.7	%
		$I_{\text{P}} = I_{\text{PR}(\text{max})}$, $T_A = -40^\circ\text{C}$ to 25°C	-3.5	-2.4	-	2.4	3.5	%
Sensitivity Error Including Lifetime Drift	$E_{\text{SENS_LTD}}$	$I_{\text{P}} = I_{\text{PR}(\text{max})}$, $T_A = 25^\circ\text{C}$ to 150°C	-3.5	-2.4	-	2.4	3.5	%
		$I_{\text{P}} = I_{\text{PR}(\text{max})}$, $T_A = -40^\circ\text{C}$ to 25°C	-3.4	-2.3	-	2.3	3.4	%
Zero Current Reference Error Including Lifetime Drift	$V_{\text{RE_LTD}}$	$V_{\text{REFactual}} - V_{\text{REFideal}}$, $I_{\text{P}} = 0 \text{ A}$, $T_A = 25^\circ\text{C}$ to 125°C , $T_A = -40^\circ\text{C}$ to 25°C	-11	-7	-	7	11	mV
Offset Error Including Lifetime Drift	$V_{\text{OE_LTD}}$	$V_{\text{IOUT(Q)}} - V_{\text{REF}}$, $I_{\text{P}} = 0 \text{ A}$, $T_A = 25^\circ\text{C}$ to 125°C	-15	-9	-	9	15	mV
		$V_{\text{IOUT(Q)}} - V_{\text{REF}}$, $I_{\text{P}} = 0 \text{ A}$, $T_A = -40^\circ\text{C}$ to 25°C	-11	-7	-	7	11	mV
QVO Error Including Lifetime Drift	$V_{\text{QE_LTD}}$	$V_{\text{IOUT(Q)}}$, $I_{\text{P}} = 0 \text{ A}$, $T_A = 25^\circ\text{C}$ to 125°C	-17	-9	-	9	17	mV
		$V_{\text{IOUT(Q)}}$, $I_{\text{P}} = 0 \text{ A}$, $T_A = -40^\circ\text{C}$ to 25°C	-14	-8	-	8	14	mV

^[1] Absolute Min. and Absolute Max are the production limits in which the device will not exceed.

^[2] -3 σ and +3 σ are mean \pm 3 σ values and are determined such that 99.73% of devices lie within the interval during initial characterization.

^[3] Lifetime drift characteristics are based on a statistical combination of production distributions and worst case distribution of parametric drift of individuals observed during AEC-Q100 qualification.

FUNCTIONAL DESCRIPTION

Power-On Reset Operation

The descriptions in this section assume: temperature = 25°C, with the labeled test conditions. The provided graphs in this section show V_{IOUT} moving with V_{CC} . The voltage of V_{IOUT} during a high-impedance state will be most consistent with a known load (R_L, C_L).

POWER-ON/POWER-OFF

As V_{CC} ramps up, the V_{IOUT} and V_{REF} outputs are high impedance until V_{CC} reaches and passes $V_{POR(H)}$ [1] in Figure 4. V_{REF} and V_{IOUT} will continue to report until V_{CC} is less than $V_{POR(L)}$ [5] in Figure 4, at which point they will go high impedance. Note that the time it takes the output to reach a steady state will depend on the external circuitry used.

POWER-ON DELAY (t_{POD})

When the supply is ramped to $V_{POR(H)}$ [2] in Figure 4, the device will require a finite time to power its internal components before the outputs are released from high impedance and can respond to an input magnetic field. Power-On Time, t_{POD} , is defined as the time it takes for the output voltage to settle within $\pm 10\%$ of its steady-state value under an applied magnetic field, which can be seen as the time from [1] to [A] in Figure 5. After this delay, the output will quickly approach $V_{IOUT(IP)} = Sens \times IP + V_{REF}$.

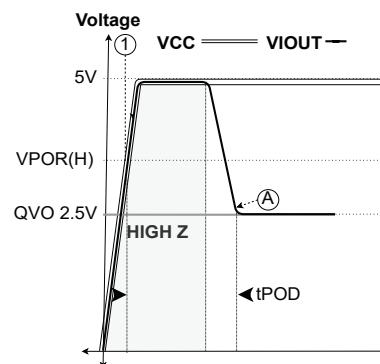

Figure 5: t_{POD} , $R_L =$ Pull-Up

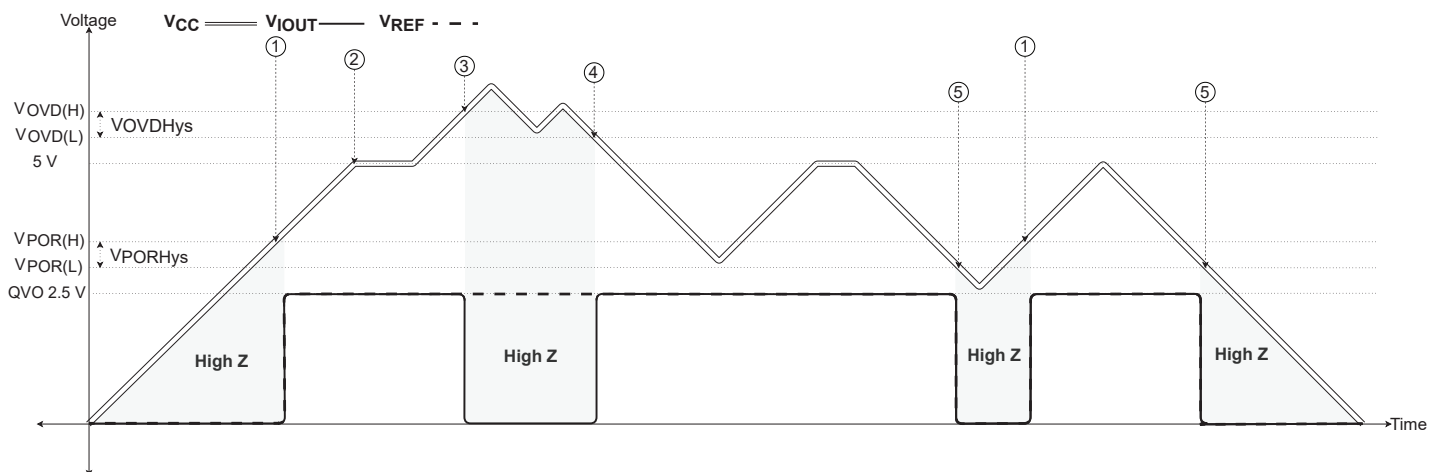

Figure 4: Power States Thresholds with V_{IOUT} Behavior for a 5 V Device, $R_L =$ Pull-Down

Overvoltage Detection (OVD)

To ensure that the device output is reporting accurately, the device contains an overvoltage detection flag. This flag on V_{IOUT} can be used to alert the system that the supply voltage is outside of the operational limits. When V_{CC} raises above $V_{OVD(H)}$ [3] in Figure 6, V_{IOUT} will go high impedance and be pulled by the load resistor to V_{CC} or GND. V_{REF} continues to output normally.

There is hysteresis between OVD enable and disable thresholds to reducing nuisance flagging and clears.

The enable time for OVD, $t_{OVD(E)}$, is the time from $V_{OVD(H)}$ [4] to OVD flag [B] in Figure 6. The enable flag for OVD has a counter to reduce transients faster than $64 \mu s$ from triggering nuisance flags.

The disable time for OVD, $t_{OVD(D)}$, is the time from $V_{OVD(L)}$ [5] until the device returns to normal operation [C] in Figure 6. The OVD disable time does not have a counter.

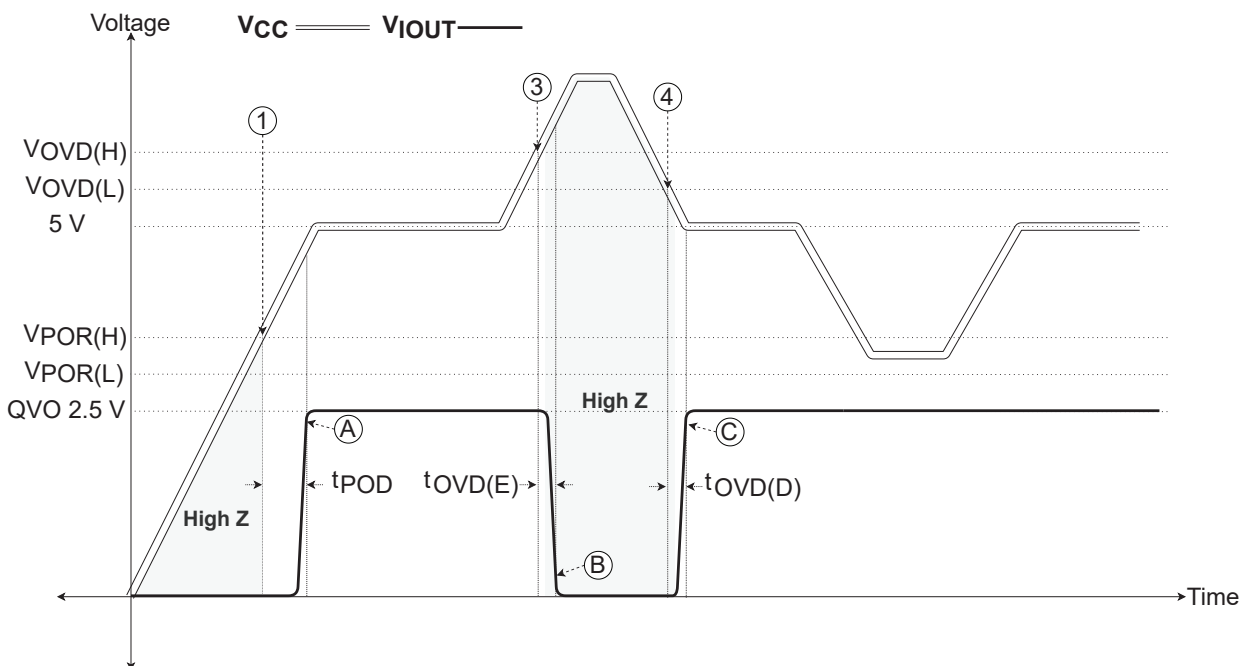

Figure 6: t_{POD} and $t_{OVD(E/D)}$ with $R_L = \text{Pull-Up}$

Absolute Maximum Ratings

These are the maximum application or environmental conditions that the device can be subjected before damage may occur.

SUPPLY ZENER CLAMP VOLTAGES

If the voltage applied to the device continues to increase past overvoltage detection, there is a point when the Zener diodes will turn on. These internal diodes are in place to protect the device from short high voltage or ESD events and should not be used as a feature to reduce the voltage on a line. Continued exposure to voltages higher than normal operating voltage, V_{CC} , can weaken or damage the Zener diodes, which will potentially damage the part.

FORWARD AND REVERSE SUPPLY VOLTAGE

These are the largest voltage magnitudes that can be supplied to V_{CC} from GND during programming or transient switching. This voltage should not be used as a DC voltage bias for an extended time.

FORWARD AND REVERSE OUTPUT VOLTAGE

The Forward Output Voltage or V_{FIOUT} voltage can be no greater than $V_{CC} + 0.5$ up to 6.5 V. This is the greatest voltage that the output can be biased with from GND during programming or transient switching. The Reverse Output Voltage or V_{RIOUT} should not drop below -0.5 V during programming or transient switching. These voltages should not be used as a DC voltage bias for an extended time.

FORWARD AND REVERSE REFERENCE/FAULT VOLTAGE

The Forward Reference/Fault Voltage or V_{F-RF} voltage can be no greater than $V_{CC} + 0.5$ up to 6.5 V. This is the greatest voltage that the V_{REF} and V_{OCF} can be biased with from GND during programming or transient switching. The Reverse Output Voltage or V_{R-RF} should not drop below -0.5 V during programming or transient switching. These voltages should not be used as a DC voltage bias for an extended time.

OUTPUT SOURCE AND SINK CURRENT

This is the maximum current that V_{IOUT} can passively sink or source before damage may occur.

AMBIENT TEMPERATURE (T_A)

This is the ambient temperature of the device. The Operating Ambient Temperature Range is the ambient temperature range that the Common Electricals and Common Performance Characteristics limits are valid. The Optimized Ambient Temperature Range is the ambient temperature range that the device-specific performance characteristics limits are valid. ACS37002L devices have optimized performance in the -40°C to 150°C (“L” temperature) range. ACS37002K devices have optimized performance in the -40°C to 125°C (“K” temperature) range. The -40°C to 125°C (“K” temperature) range devices have Device Specific Performance optimized within the -40°C to 125°C temperature range but will still operate in the -40°C to 150°C (“L” temperature) range.

DEFINITIONS OF OPERATING AND PERFORMANCE CHARACTERISTICS

Zero Current Voltage Output ($V_{IOUT(Q)}$, QVO)

Zero Current Voltage Output or $V_{IOUT(Q)}$ (also called QVO) is defined as the voltage on the output, V_{IOUT} when zero amps are applied through I_P .

QVO Temperature Drift (V_{QE})

QVO Temperature Drift, or V_{QE} , is defined as the drift of QVO from room to hot or room to cold (25°C to 125/150°C or 25°C to -40°C respectively). To improve over temperature performance the temperature drift is compensated with Allegro factory trim to remain within the limits across temperature.

Reference Voltage (V_{REF})

There is a Voltage Reference Output, (V_{REF}) on the ACS37002. This output reports the zero current voltage for the output channel V_{IOUT} allowing for differential measurement and a device referred supply for the VOC pin.

Reference Voltage Temperature Drift (V_{RE})

Reference Voltage Temperature Drift, or V_{RE} , is defined as the drift of V_{REF} from room to hot or room to cold (25°C to 125/150°C or 25°C to -40°C respectively).

Offset Voltage (V_{OE})

Offset Voltage, or V_{OE} , is defined as the difference between QVO and V_{REF} (see Figure 7). V_{OE} includes the drift of QVO minus V_{REF} from room to hot or room to cold (25°C to 125/150°C or 25°C to -40°C respectively).

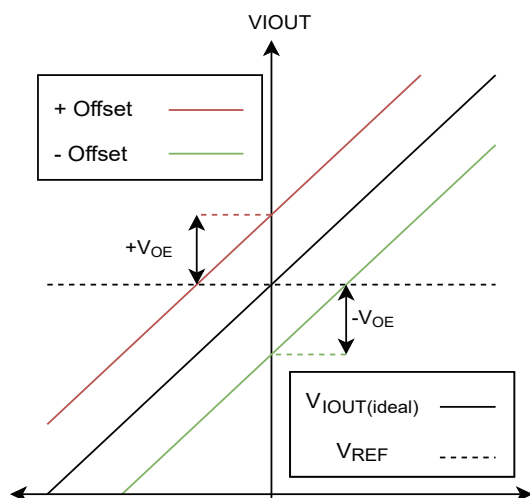

Figure 7: Offset (V_{OE}) Between V_{IOUT} and V_{REF}

Output Saturation Voltage ($V_{SAT(HIGH/LOW)}$)

Output Saturation Voltage, or V_{SAT} , is defined as the voltage that the V_{IOUT} does not pass as a result to an increasing magnitude of current. $V_{SAT(HIGH)}$ is the highest voltage the output can drive to while, $V_{SAT(LOW)}$ is the lowest. This can be seen in Figure 8. Note that changing the sensitivity does not change the V_{SAT} points.

OUTPUT VOLTAGE OPERATING RANGE (V_{OOR})

The Output Voltage Operating Range, or V_{OOR} , is the functional range for linear performance of V_{IOUT} and its related datasheet parameters. This can be seen in Figure 8. The V_{OOR} is the output region that the performance accuracy parameters are valid. It is possible for the output to report beyond these voltages until V_{SAT} , but certain parameters cannot be guaranteed. The output performance is demonstrated in Figure 8 through and beyond the V_{OOR} .

Voltage Output Operating Range for V_{CC} and Output Modes, $V_{OOR}(V_{CC}, Mode)$		
V_{CC} (V)	Bidirectional	Unidirectional
3.3	± 1.32	+2.64
5	± 2	+4

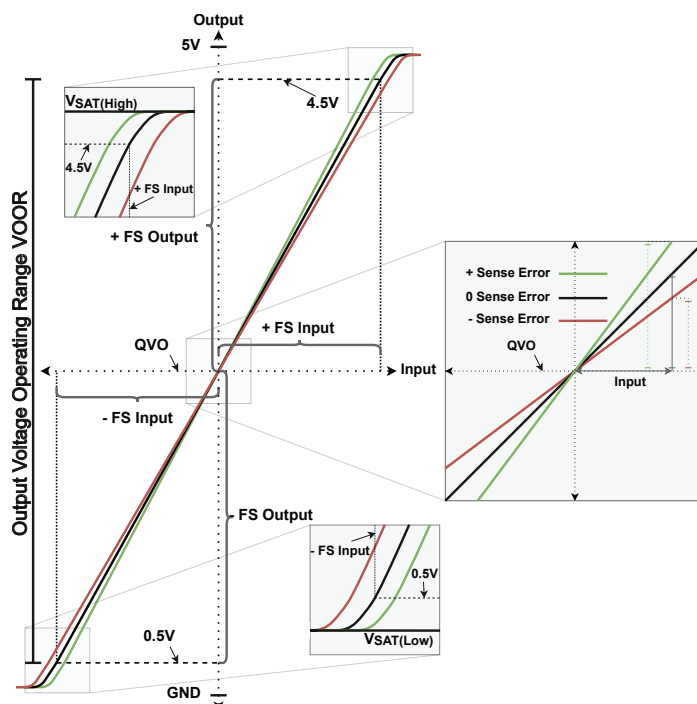

Figure 8: V_{OOR} , V_{SAT} and SENS with Full Scale

Sensitivity (Sens)

Sensitivity, or Sens, is the ratio of the output swing versus the applied current through the primary conductor, I_P . This current causes a voltage deviation away from QVO on the V_{IOUT} output until V_{SAT} . The magnitude and direction of the output voltage swing is proportional to the magnitude and direction of the applied current. This proportional relationship between output and input is Sensitivity and is defined as:

$$Sens = \frac{V_{IOUT(I1)} - V_{IOUT(I2)}}{I_1 - I_2}$$

where I_1 and I_2 are two different currents, and where $V_{IOUT(I1)}$ and $V_{IOUT(I2)}$ are the voltages of the device at the applied currents. V_{IOUT} , I_1 , or I_2 can be QVO with zero current.

Sensitivity Error (E_{sens})

Sensitivity Temperature Drift, or E_{sens} , is the drift of Sens from room to hot or room to cold (25°C to 125°C or 25°C to -40°C respectively). No trimming/programming is needed as temperature drift is compensated with Allegro factory trim.

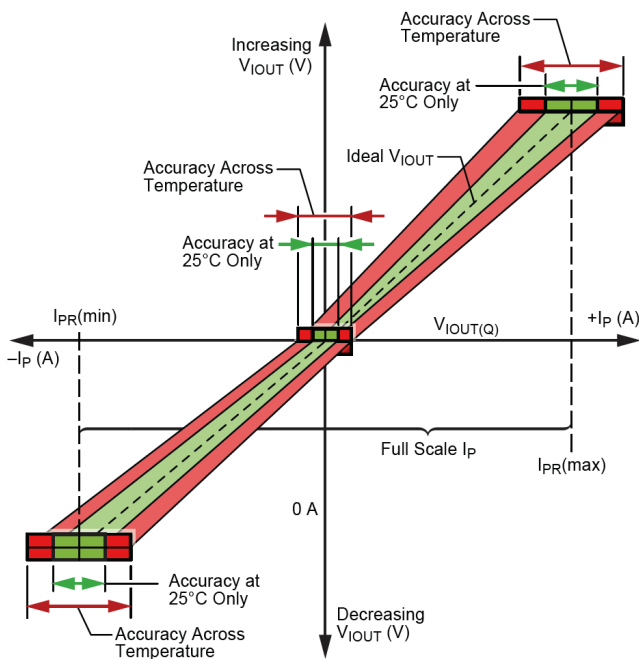

Figure 9: Output Accuracy Pocket for Room and Across Temperature

Gain Selection Pins

The ACS37002 features external gain selection pins that configure the device sensitivity. The gain select logic is latched based on the pin voltage at startup. Either pin may be shorted directly to VCC or GND, which is logic 1 or 0 respectively. Both pins include an internal 1 MΩ pull-down resistor to GND. Externally floating pins will be interpreted as logic 0; if both pins are floating, the device will be in the 00 configuration. Specific gain select performance can be found in the selection Performance Characteristics table. To change the gain of the device, refer to Figure 18 in the Application and Theory section.

Full Scale (FS)

Full Scale, or FS, is a method to relate an input and/or output to the max input and/or output of the device. For example, 50%FS of a 10A sensor is 5A, or 50% of its maximum input current. The 50% input of 5A will cause the output to move 50%, or 50%FS. FS is used to interchangeably refer to input and output deviations when discussing input steps, fault trip thresholds and relating input to output performance. FS_{INPUT} is the input bias that results in FS_{OUTPUT} and these two are directly related by the device actual sensitivity. Both FS input and output can be seen in Figure 8, labeled as positive or negative FS input and FS output. The equation for input referred FS for a 5V bidirectional device is:

$$FS = \frac{V_{OOR(5V,BI)}}{Sens_{Actual}} = \pm \frac{2V}{Sens_{Actual}}$$

Note: that a percentage change in FS_{INPUT} is equivalent to a resultant percentage change of FS_{OUTPUT} and visa versa.

Nonlinearity (E_{LIN})

As the amount of field applied to the part changes, the sensitivity of the device can also change slightly. This is referred to as linearity error or E_{LIN} (see Figure 10). Consider two currents, I_1 (1/2 FS) and I_2 (FS). Ideally, the sensitivity of the device is the same for both fields. Linearity Error is calculated as the percent change in sensitivity from one field to another. Error is calculated separately for positive ($E_{LIN(+)}$) and negative ($E_{LIN(-)}$) currents, and the percent errors are defined as:

$$E_{LIN(\pm)} = \left(1 - \frac{Sens_{I2\pm}}{Sens_{I1\pm}} \right) \times 100\%$$

where:

$$Sens_{IX+} = \frac{V_{IOUT(IX+)} - V_{REF}}{I_{X+}}$$

$$Sens_{IX-} = \frac{V_{IOUT(IX-)} - V_{REF}}{I_{X-}}$$

I_x are positive and negative currents through I_p , such that $|I_{+2}| = 2 \times |I_{+1}|$ and $|I_{-2}| = 2 \times |I_{-1}|$. $E_{LIN} = \max(E_{LIN(+)}, E_{LIN(-)})$

Total Output Error (E_{TOT})

The Total Output Error is the current measurement error from the sensor IC as a percentage of the actual applied current. This is equivalent to the difference between the ideal output voltage and the actual output voltage, divided by the ideal sensitivity, relative to the current applied to the device, or simplified to:

$$E_{TOT} = \frac{V_{IOUT(ACTUAL)} - (Sens_{(IDEAL)} \times I_{PR} + V_{REF})}{(Sens_{(IDEAL)} \times I_{PR})} \times 100$$

Total Output Error incorporates all sources of error and is a function of current. At relatively high currents, Total Output Error will be mostly due to sensitivity error, and at relatively low inputs, Total Output Error will be mostly due to Offset Voltage (V_{OE}). At $I = 0$ A, Total Output Error approaches infinity due to the offset. An example of total error at FS can be seen in Figure 10.

Note: Total Output Error goes to infinity as the amount of applied field approaches 0 A.

Power Supply Offset Error (V_{PS})

Power Supply Offset Error or $V_{OE(PS)}$ is defined as the offset error in mV between V_{CC} and $V_{CC} \pm 10\% V_{CC}$. For a 5 V device, this is 5 to 4.5 V and 5 to 5.5 V. For a 3.3 V device, this is 3.3 to 3 V and 3.3 to 3.6 V.

Offset Power Supply Rejection Ratio (PSRR_O)

The Offset Power Supply Rejection Ratio or PSRR_O is defined as $20 \times \log$ of the ratio of the change of QVO in volts over a ± 100 mV variable AC V_{CC} centered at 5 V reported as dB in a specified frequency range. This is an AC version of the $V_{OE(PS)}$ parameter. The equation is shown below:

$$PSRR_O = 20 \times \log \left(\frac{\Delta QVO}{\Delta V_{CC}} \right)$$

Power Supply Sensitivity Error (E_{PS})

Power Supply Sensitivity Error, or $E_{Sens(PS)}$, is defined as the percent sensitivity error measured between V_{CC} and $V_{CC} \pm 10\%$. For a 5 V device, this is 5 to 4.5 V and 5 to 5.5 V. For a 3.3 V device, this is 3.3 to 3 V and 3.3 to 3.6 V.

Sensitivity Power Supply Rejection Ratio (PSRR_S)

The Sensitivity Power Supply Rejection Ratio or PSRR_S is defined as $20 \times \log$ of the ratio of the % change the sensitivity over the % change in V_{CC} (± 100 mV variable AC V_{CC} centered at 5 V) reported as dB in a specified frequency range. This is the AC version of the $E_{Sens(PS)}$ parameter. The equation is shown below:

$$PSRR_S = 20 \times \log \left(\frac{\Delta \% Sens}{\Delta V_{CC}} \right)$$

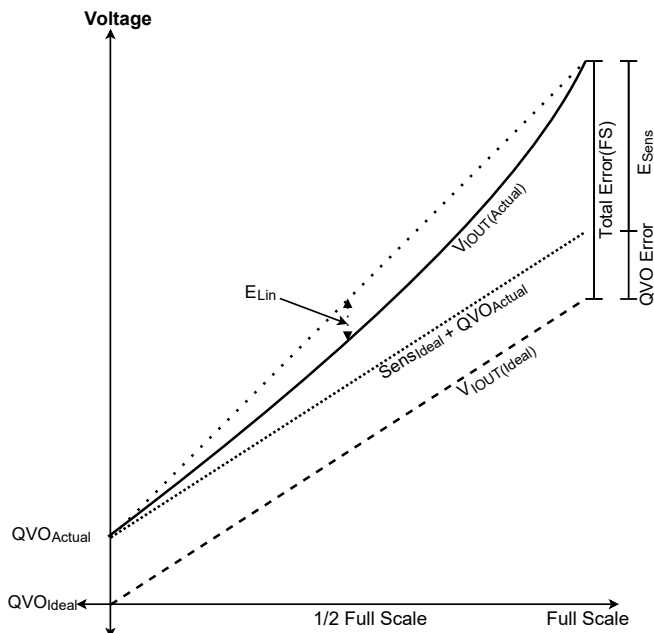

Figure 10: Accuracy Error

FAULT BEHAVIOR

Overcurrent Fault (OCF)

As the output swings, the Overcurrent Fault pin will trigger with an active low flag if the sensed current exceeds its comparator threshold. This is internally compared with either the factory-programmed thresholds or via the VOC voltage when $V_{VOC} > 0.1$ V. This flag trips symmetrically for the positive and negative OCF operating point.

The implementation for the OCF circuitry is accurate over temperature and does not require further temperature compensation as it is dependent on the Sens and V_{OFF} parameters that are factory-trimmed flat over temperature.

OVERCURRENT FAULT OPERATING RANGE/POINT (I_{OCF-OR} , I_{OCF-OP})

Overcurrent Fault Operating Range is the functional range that the OCF thresholds can be set in terms of percentage of full-scale output swing. The Overcurrent Fault Operating Point is the specific point at which the OCF trigger will occur, and is set by either V_{VOC} or the factory default setting. The I_{OCF-OP} can be seen in Figure 11 as [9] along with the FAULT pin functionality.

OVERCURRENT FAULT HYSTERESIS ($I_{OCF-HYST}$)

Overcurrent Fault Hysteresis or $I_{OCF-HYST}$ is defined as the magnitude of percent FS that must drop before a fault assertion will be cleared. This can be seen as the separation between the voltages [9] to [10] in Figure 11. Note the MASK and HOLD functionality are independent of each other. The ACS37002 comes standard with an OCF_{HYS} of 120 mV (on the output) or 6%FS for a 5 V device and 9%FS for a 3.3 V device.

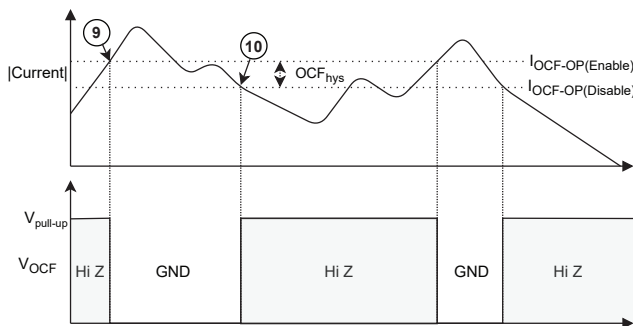

Figure 11: Fault Thresholds and OCF Pin Functionality

VOLTAGE OVERCURRENT PIN (VOC)

The fault trip points can be set using the VOC pin as the direct analog input for the fault trip point. The VOC pin voltage can be set using resistor dividers from V_{REF} on bidirectional devices. The fault performance is valid when V_{VOC} is within the VOC Operating Voltage Range or < 0.1 V. The device will respond to voltage outside of the defined valid performance region with varied results. For a 5 V bidirectional device, setting the VOC pin to 0.5 V selects the minimum trip point, $I_{FAULT(min)}$, and setting the pin to 2 V selects the maximum trip point, $I_{FAULT(max)}$ as defined by selection performance tables. All voltages between 0.5 to 2 V for 5 V option and 0.33 to 1.321 V for 3.3 V option can linearly select a trip point between the minimum and maximum levels, as shown in Figure 12. When $V_{OC} < 0.1$ V, the internal EEPROM fault level will be used.

The resulting equation for the fault is:

$$OCF_{\%FS} [\%] = \frac{V_{OC(VCC)} [V]}{V_{OC(VCC)100\%} [V]} \times 100 [\%]$$

$$I_{OCF} [A] = OCF_{\%FS} [\%] \times I_{PR} [A]$$

Table 1: $V_{OC(VCC)}$ thresholds and corresponding percentage of the Full-Scale Output for Bidirectional and Unidirectional operational modes

$V_{OC(3.3V)}$ (V)	$V_{OC(5V)}$ (V)	Fault Operation Point %FS	
		Bidirectional	Unidirectional
<0.1		100% (factory default)	50% (factory default)
0.330	0.5	50%	25%
0.466	0.75	75%	37.5%
0.661	1	100%	50%
0.826	1.25	125%	62.5%
0.991	1.5	150%	75%
1.156	1.75	175%	85%
1.321	2	200%	100%

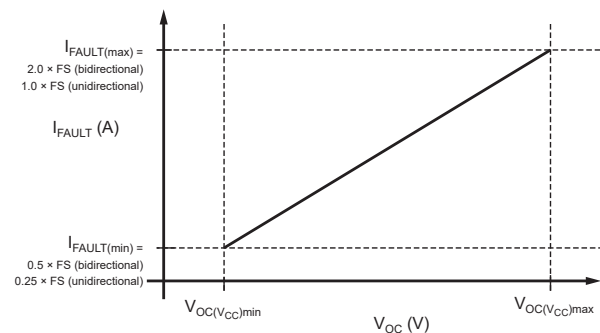

Figure 12: VOC Functional Range

OVERCURRENT FAULT ERROR (E_{OCF})

Fault Error or E_{OCF} is the error between the $I_{OCF-OP(actual)}$ and $I_{OCF-OP(ideal)}$.

OVERCURRENT FAULT RESPONSE TIME (t_{OCF})

Overcurrent Response Time or t_{OCF} is defined as the time from the input reaches the operating point [9] (seen in Figure 13) until the OCF pin falls below $V_{FAULT-ON}$ [G]. If the OCF Mask is disabled, then t_{OCF} is equal to t_{OCF-R} seen as the time from [9] until [F].

OVERCURRENT FAULT REACTION TIME (t_{OCF-R})

Overcurrent Reaction Time or t_{OCF-R} is defined as the time from the current input rising above I_{OCF-OP} at point [9] in Figure 13 until the OCF pin reaches V_{OCF-ON} at point [F] with the OCF mask disabled. This is the time required for the device to recognize and clear the fault, seen as the time between [10] until [I].

OVERCURRENT FAULT MASK TIME ($t_{OCF-MASK}$)

Overcurrent Fault Mask Time or $t_{OCF-MASK}$ is defined as the additional amount of time the OCF must be present beyond the t_{OCF-R} time (seen in Figure 13 [F] until [G]). This is to reduce nuisance tripping of the FAULT pin. If an OCF occurs, but does not persist beyond $t_{OCF-R} + t_{OCF-MASK}$, it is not reported by the device (seen in Figure 14). This prevents short transient spikes from causing erroneous OCF flagging. Factory default setting is $t_{OCF-MASK} = 0 \mu s$.

OVERCURRENT FAULT HOLD TIME ($t_{OCF-HOLD}$)

Overcurrent Fault Hold Time or $t_{OCF-HOLD}$ is defined as the minimum time OCF flag will be asserted after a sufficient OCF event. After the hold time has been reached, the OCF will release if the OCF condition has ended (seen in Figure 13 [G] until [J]) or persist if the OCF condition is still present (seen in Figure 15 [G] until [J]). Factory default is 0 ms.

OVERCURRENT FAULT PERSIST

The ACS37002 has a fault persist option that will maintain the OCF flag if a flag occurred until a POR event.

OCF DISABLE

The ACS37002 has the ability to disable overcurrent fault functionality; when this is disabled, the OCF pin will remain in high Z.

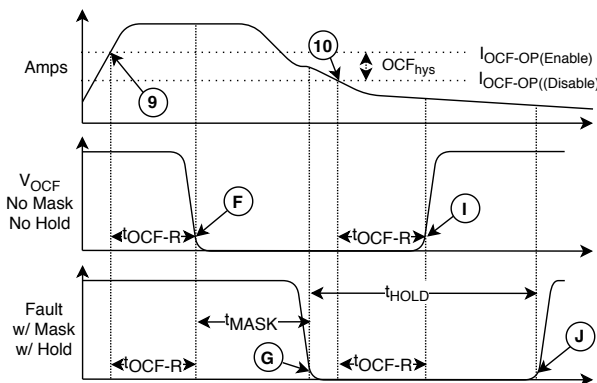

Figure 13: General Fault Timing.
Note: the MASK and HOLD functionality are independent of each other

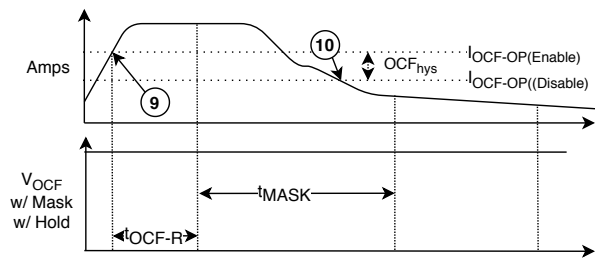

Figure 14: Fault Condition Clearing Before Mask Time Is Reached

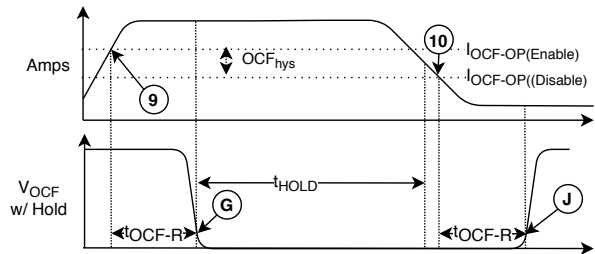

Figure 15: Fault Hold with Clear Fault After Hold Time

RESPONSE CHARACTERISTICS DEFINITIONS AND PERFORMANCE DATA

Response Time (t_{RESPONSE})

The time interval between a) when the sensed input current reaches 90% of its final value, and b) when the sensor output reaches 90% of its full-scale value.

Propagation Delay (t_{pd})

The time interval between a) when the sensed input current reaches 20% of its full-scale value, and b) when the sensor output reaches 20% of its full-scale value.

Rise Time (t_r)

The time interval between a) when the sensor reaches 10% of its full-scale value, and b) when it reaches 90% of its full-scale value.

Output Slew Rate (SR)

The rate of change [V/ μs] in the output voltage from a) when the sensor reaches 10% of its full-scale value, and b) when it reaches 90% of its full-scale value.

Response Time, Propagation Delay, Rise Time, and Output Slew Rate

Applied current step with 10%-90% rise time = 1 μs

Test Conditions: $T_A = 25^\circ\text{C}$, $C_{\text{BYPASS}} = 0.1 \mu\text{F}$, $C_L = 6 \text{ nF}$

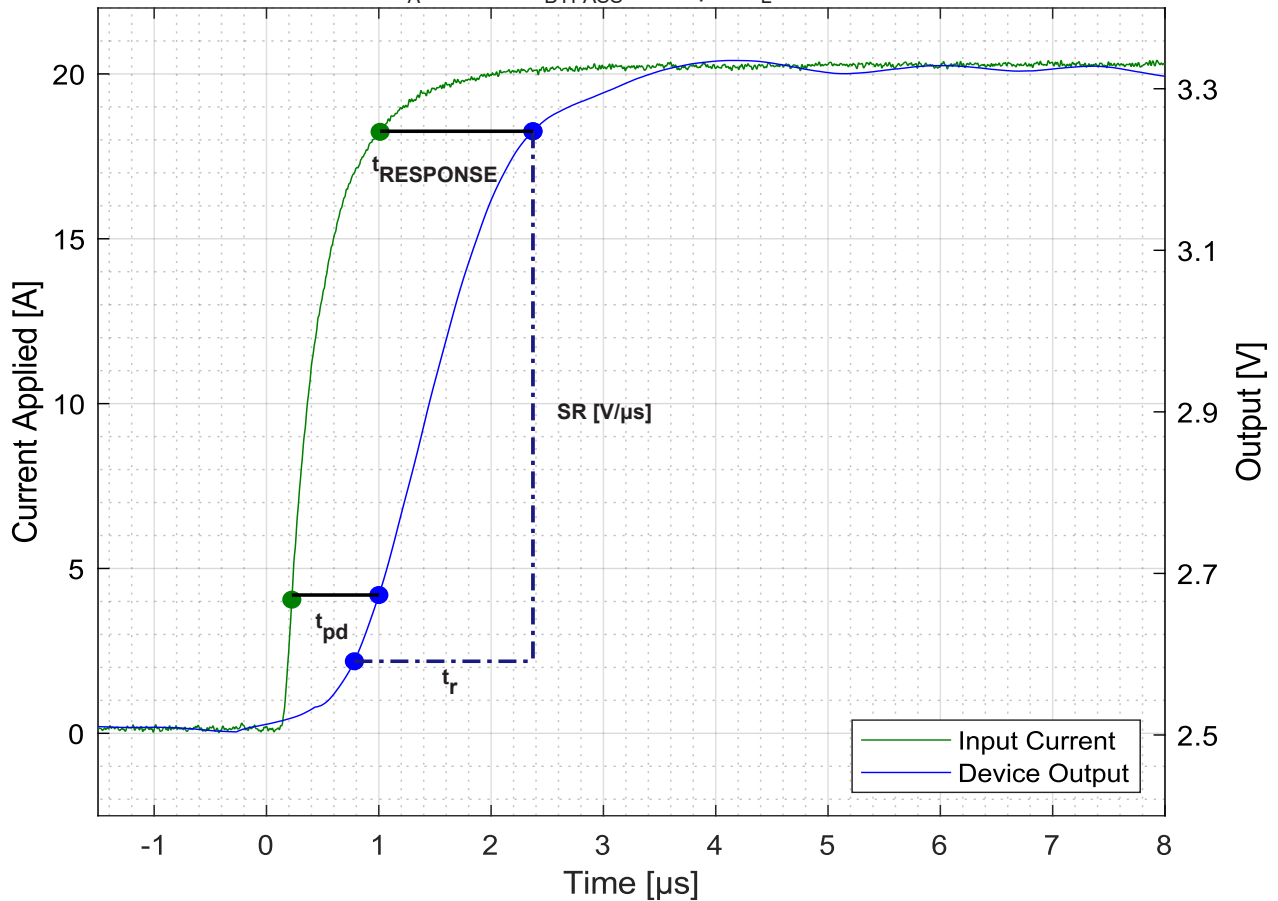

Temperature Compensation

To help compensate for the effects temperature has on performance, the ACS37002 has an integrated internal temperature sensor. This sensor and compensation algorithms help to standardize device performance over the full range of optimized temperatures. This allows for room temperature system calibration and validation of end-of-line modules.

Temperature Compensation Update Rate

There is an 8 ms update time that is required to maintain a valid temperature compensated output; that is, temperature compensations are calculated and applied every 8 ms.

APPLICATION AND THEORY

Application Circuits

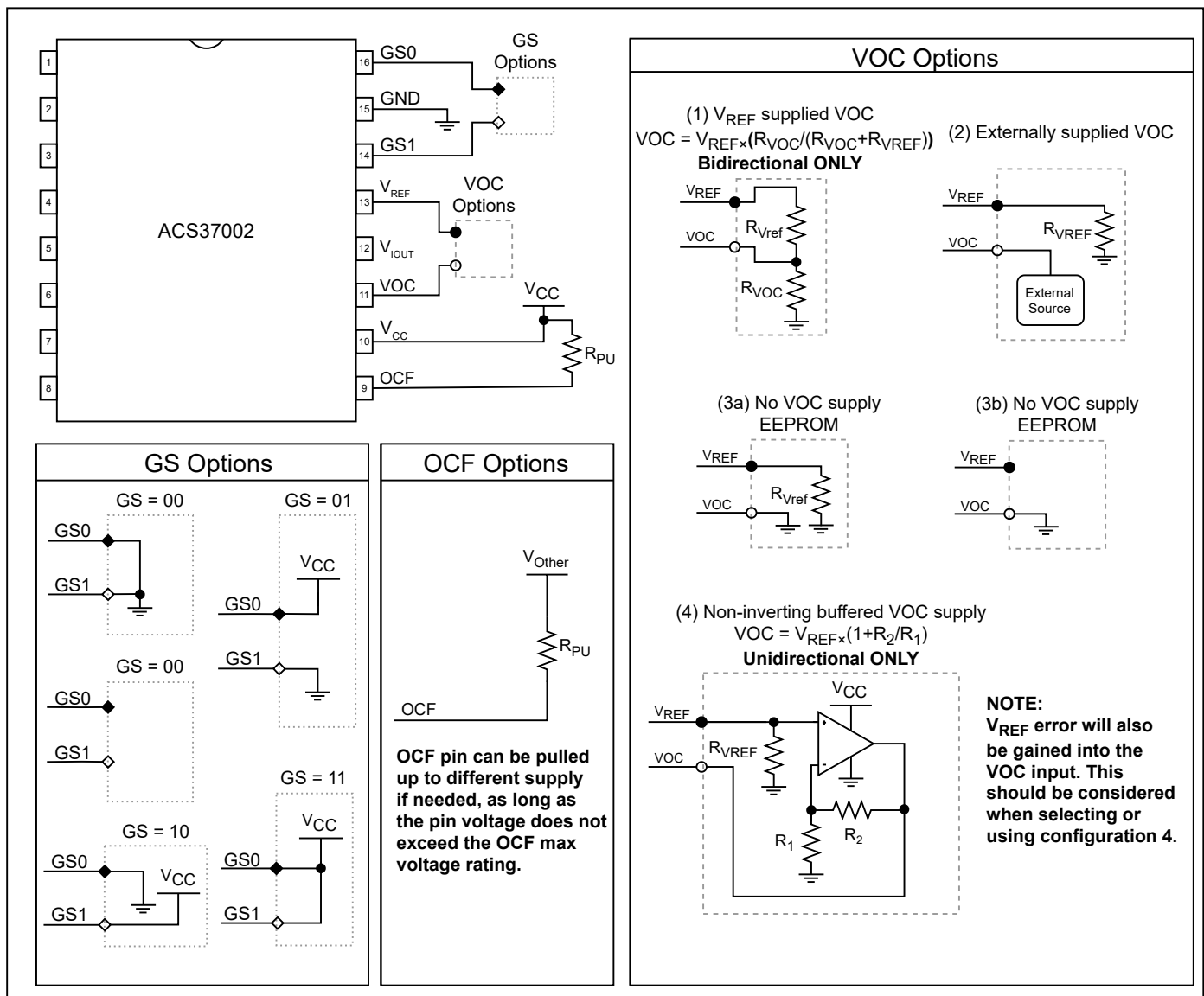

Figure 16: Applications Circuits for GAIN_SEL, VOC, and FAULT pin

These configurations are simplified to the network required for functionality.

Bypass and load capacitors are recommend for best performance.

Theory and Functionality – VOC and OCF

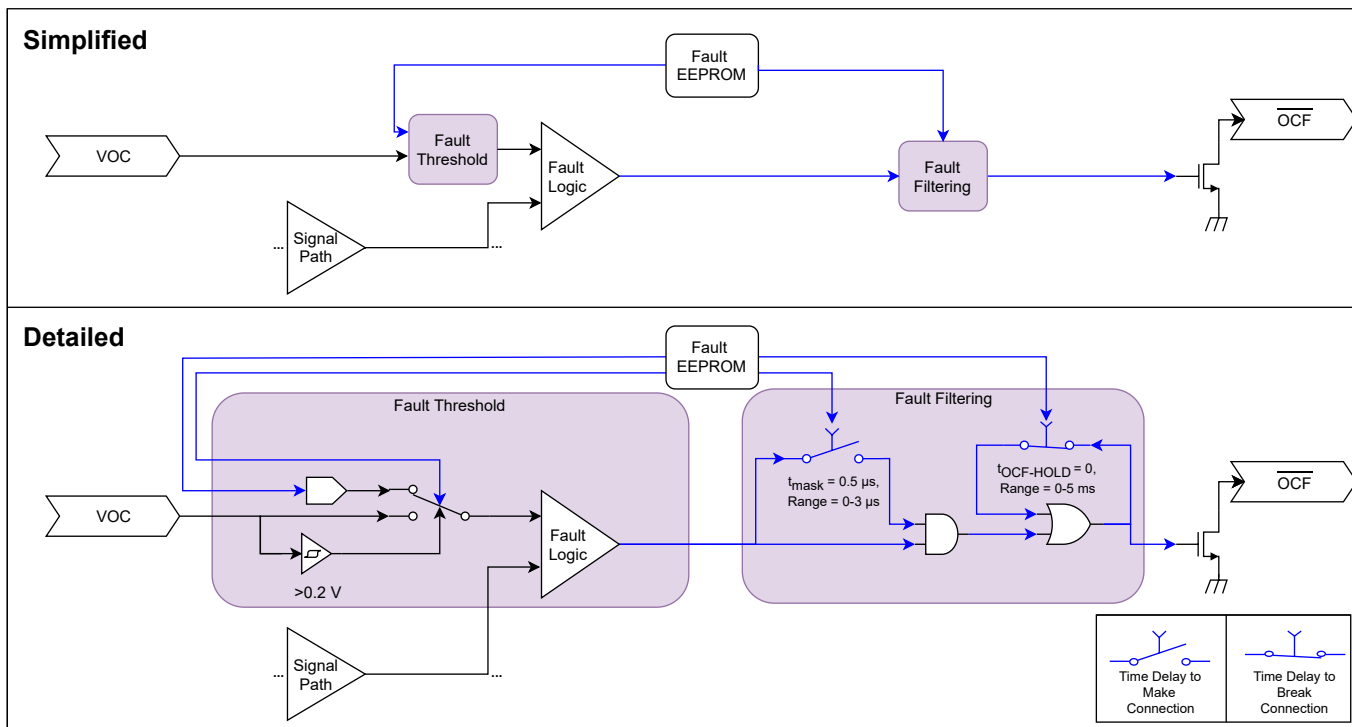

Figure 17: OCF Signal Path Simplified and Detailed Blocks of Functionality

VOC DRIVEN BY NON-INVERTING BUFFERED VREF

If the VOC pin is being driven by a non-inverted buffered V_{REF} , it is important to consider that any error from the V_{REF} pin will be gained as well. For instance, if V_{REF} error is +10 mV and the gain = 4 for the non-inverting operational amplifier, then the VOC pin will be 40 mV from the expected target. For unidirectional devices, OCF would be subjected to an additional 4% error due to the error propagation from V_{REF} through the gain stage.

POWER SUPPLY DECOUPLING CAPACITOR AND OUTPUT CAPACITIVE LOADS

The higher the capacitive load on the outputs (V_{REF} , V_{IOUT}), the larger the decoupling capacitor should be on the power supply (V_{CC}) to maintain performance.

C_{LOAD}	C_{BYPASS}
0 nF	>100 nF
1 nF	>100 nF
3 nF	>1 μ F
6 nF	>10 μ F

Dynamically Change Gain in a System

The ACS37002 has GAIN_SEL pins that are used to change the gain of the device on startup. If a more dynamic gain is desired, then reduce V_{CC} below $V_{POR(L)}$ and restart the device by returning V_{CC} to the nominal voltage with the new desired GAIN_SEL configuration. The GAIN_SEL pin voltage must greater than the

desired configuration voltage ($V_{H(SEL)}$ or $V_{L(SEL)}$) at or before $V_{CC} > V_{POR(H)}$ in order to successfully change the device gain. The GAIN_SEL pin voltage is latched at startup, and any changes to the pin voltages after the devices V_{IOUT} comes out of high Z will not affect gain. The cycle time to complete this operation is up to $2 \times t_{POD}$.

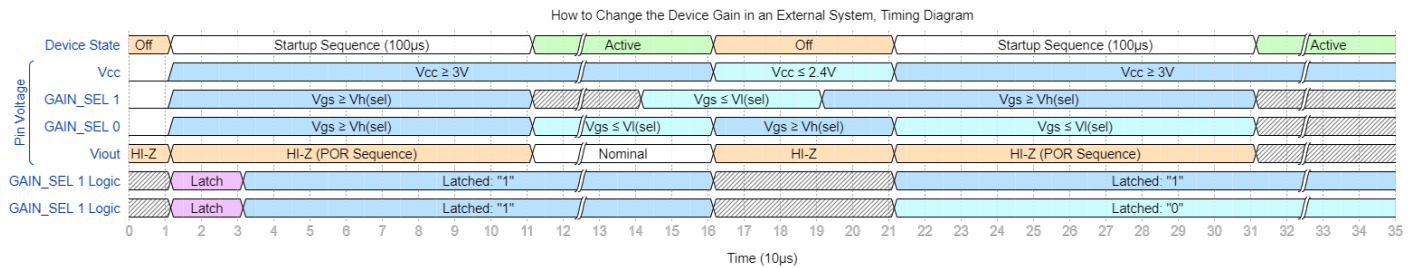

Figure 18: GAIN_SEL Dynamic Gain Changing Timing Diagram

THERMAL PERFORMANCE

Thermal Rise vs. Primary Current

Self-heating due to the flow of current should be considered during the design of any current sensing system. The sensor, printed circuit board (PCB), and contacts to the PCB will generate heat as current moves through the system.

The thermal response is highly dependent on PCB layout, copper thickness, cooling techniques, and the profile of the injected current. The current profile includes peak current, current “on-time”, and duty cycle. While the data presented in this section was collected with direct current (DC), these numbers may be used to approximate thermal response for both AC signals and current pulses.

The plot in Figure 19 shows the measured rise in steady-state die temperature of the ACS37002 versus continuous current at an ambient temperature, T_A , of 25 °C. The thermal offset curves may be directly applied to other values of T_A . Conversely, Figure 20 shows the maximum continuous current at a given T_A . Surges beyond the maximum current listed in Figure 21 are allowed given the maximum junction temperature, $T_{J(MAX)}$ (165°C), is not exceeded.

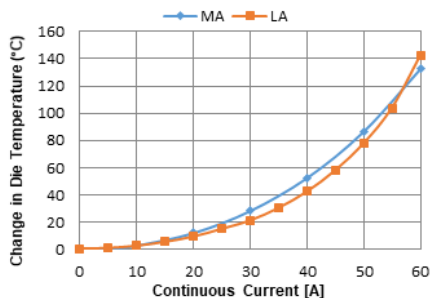

Figure 19: Self heating in the MA and LA package due to current flow

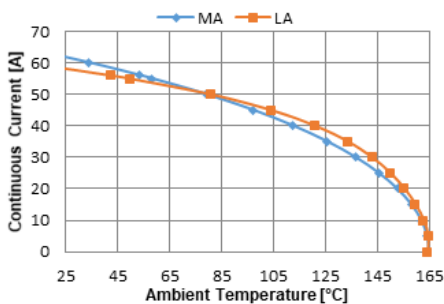

Figure 20: Maximum Continuous Current at a Given T_A

The thermal capacity of the ACS37002 should be verified by the end user and is specific to the application. The maximum junction temperature, $T_{J(MAX)}$ (165°C), should not be exceeded. Further information on this application testing is available in the DC and Transient Current Capability application note on the Allegro website (<http://www.allegromicro.com/en/Design-Center/Technical-Documents/Hall-Effect-Sensor-IC-Publications/DC-and-Transient-Current-Capability-Fuse-Characteristics.aspx>).

Evaluation Board Layout

Thermal data shown in Figure 19 and Figure 20 was collected using the ASEK37002 Evaluation Board (TED-0002825). This board includes 750 mm² of 4 oz. copper (0.1388 mm) connected to pins 1 through 4, and to pins 5 through 8, with thermal vias connecting the layers. Top and bottom layers of the PCB are shown below in Figure 21.

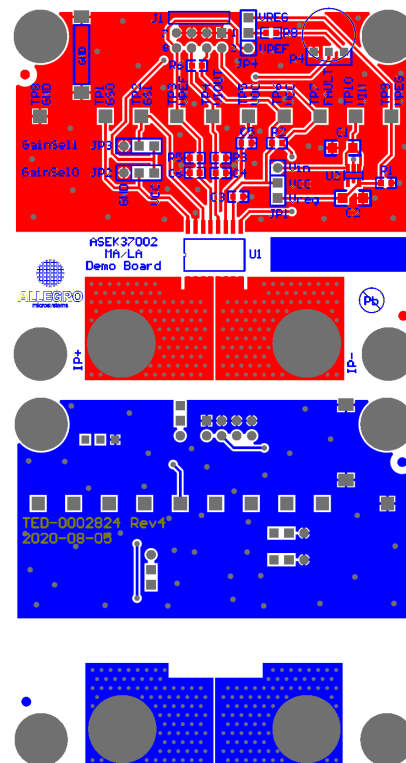

Figure 21: Top and Bottom Layers for ASEK37002 Evaluation Board

Gerber files for the ASEK37002 evaluation board are available for download from the Allegro website. See the technical documents section of the ACS37002 webpage (<https://www.allegromicro.com/en/products/sense/current-sensor-ics/zero-to-fifty-amp-integrated-conductor-sensor-ics/acs37002>).

PACKAGE OUTLINE DRAWINGS

For Reference Only – Not for Tooling Use

(Reference MS-013AA)

NOT TO SCALE

Dimensions in millimeters

Dimensions exclusive of mold flash, gate burrs, and dambar protrusions
Exact case and lead configuration at supplier discretion within limits shown

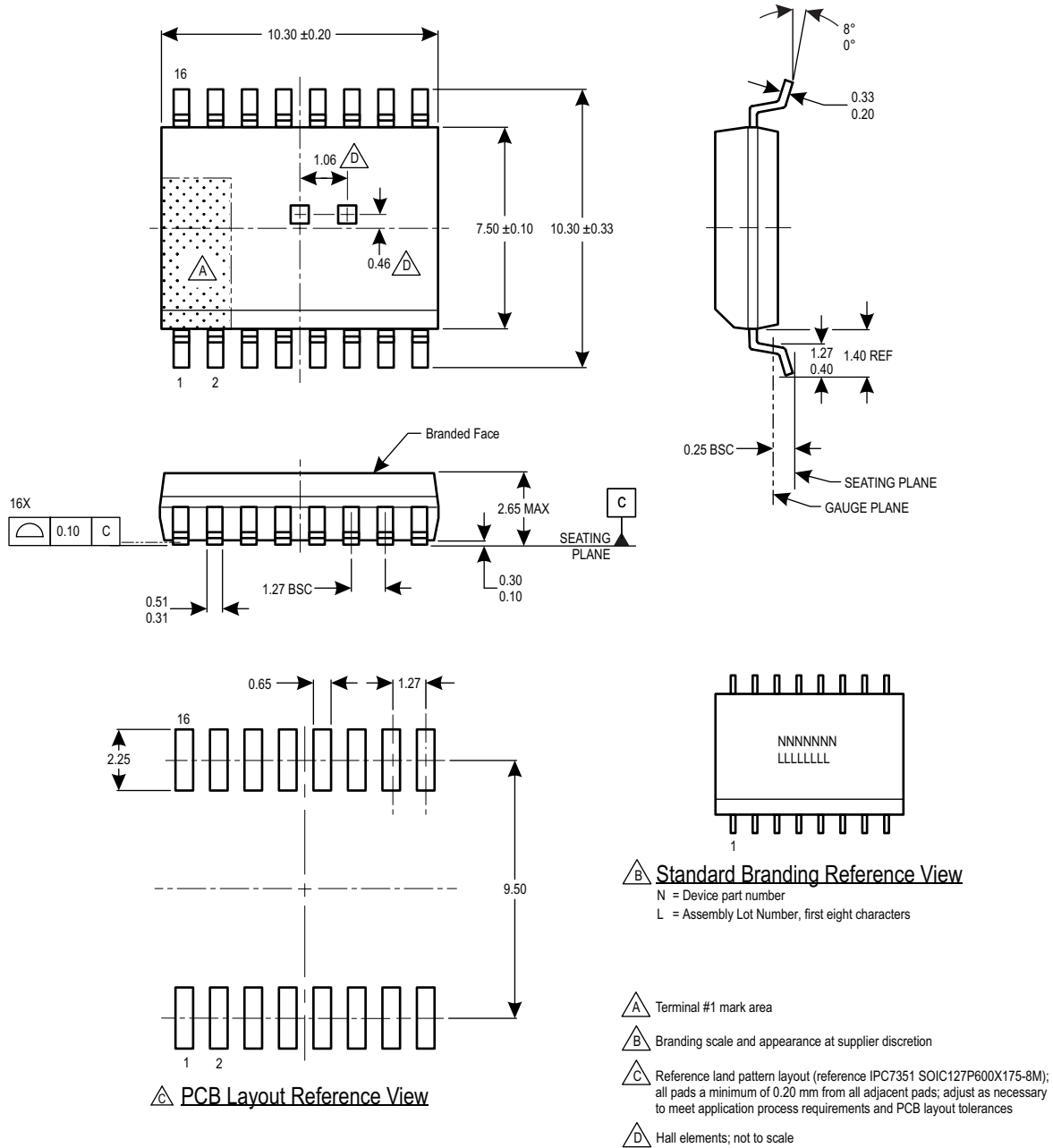

Figure 22: Package MA, 16-Pin SOICW

ACS37002

400 kHz, High Accuracy Current Sensor with Pin-Selectable Gains and Adjustable Overcurrent Fast Fault in SOICW-16 Package

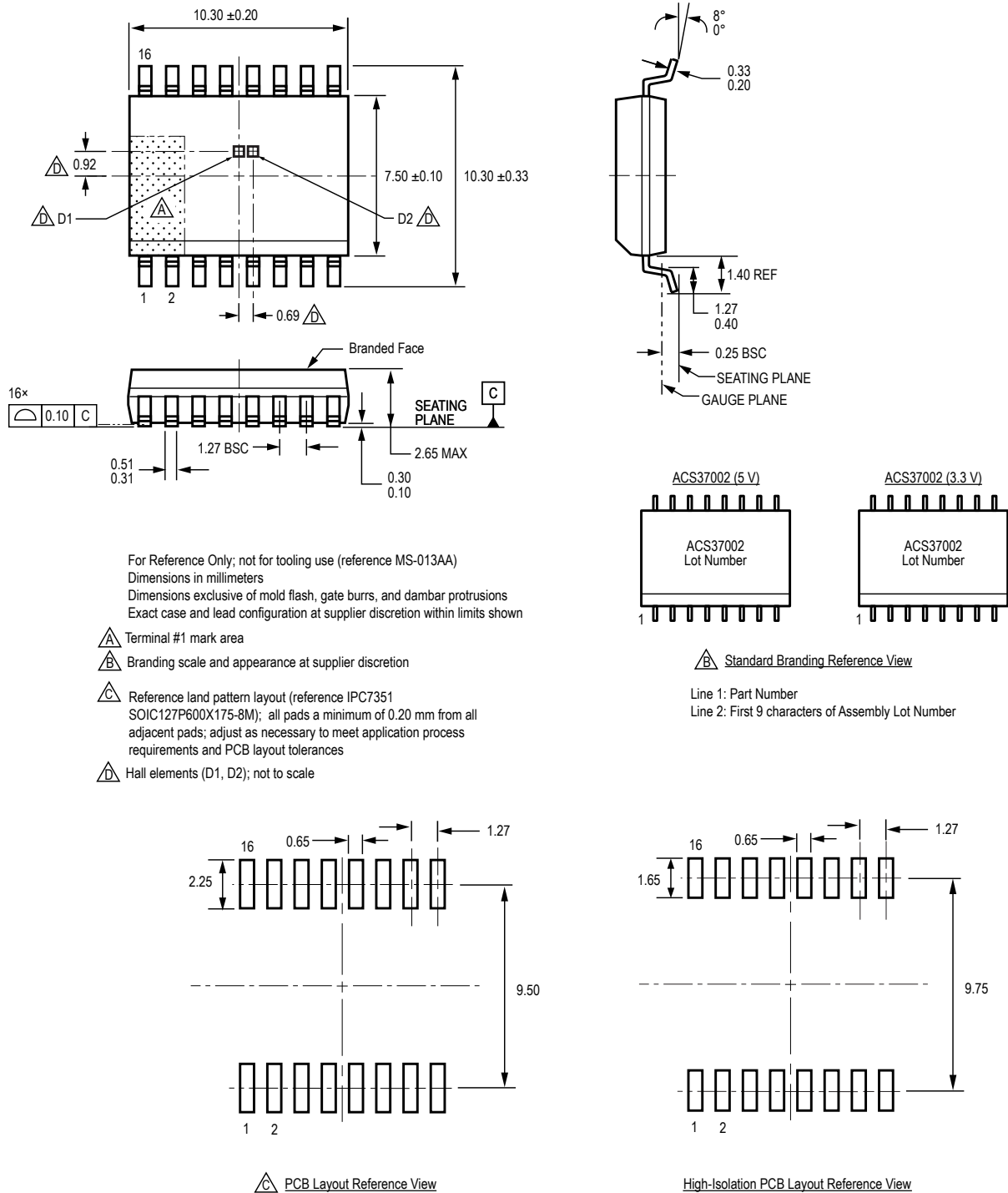

Figure 23: Package LA, 16-PIN SOICW

Revision History

Number	Date	Description
–	June 24, 2020	Initial release
1	July 8, 2020	Updated Features and Benefits, Selection Guide (page 2), Working Voltage values (page 4), Footnote 2 (pages 10-19), Voltage Overcurrent Pin section (page 30), and Branding (page 38)
2	October 16, 2020	Updated Features and Benefits, Description, and Figure 1 (page 1); added UL certification (page 2); updated Selection Guide table (page 2), Forward Output Voltage and Reverse Output Voltage symbols (page 3), Isolation Characteristics and MA Package Specific Performance tables (page 4), Supply Voltage, Supply Bypass Capacitor, Primary Conductor Resistance, Power-On Reset Voltage, Power-On Time, Undervoltage and Undervoltage Detection Threshold (page 7), Rise Time, Response Time, Propagation Delay Time, Noise Density (page 8), VOC Operating Voltage Range, OCF Reaction Time, OCF Mask, OCF Response Time (page 9); added footnote 4 (page 9); Performance Characteristic tables (pages 10-19); updated Current Sensing Range and Sensitivity values (pages 21-23); added Functional Description (pages 24-27), Definitions of Operating and Performance Characteristics (pages 28-32); updated Figure 20 (page 34), Theory and Functionality (pages 35-36).
3	December 16, 2020	Updated UVD and OVD Threshold test conditions (page 7); removed Overshoot and Settling Time sections and Figure 19 (page 33); fixed Figure 18 (page 33) graphical issue; updated Figure 19 (page 34), and other minor editorial updates.
4	May 14, 2021	Updated Features and Benefits, Description, Figure 1 caption (pages 1-2), Table of Contents (page 3); added Maximum Continuous Current (page 4), MSL Rating (page 5); updated Dielectric Strength Test Voltage (page 5), Reference Resistive Load, Primary Conductor Inductance, Typical Buffer Resistance (page 8), Internal Bandwidth, Rise Time, Response Time, Propagation Delay, Noise Density, Noise, Power Supply Rejection Ratio Offset, and Power Supply Rejection Ratio Sens test conditions (page 9), OCF Response Time test conditions and footnote 2 (page 10), Zero Current Output Voltage (page 23), Current Sensing Range, Overcurrent Fault Operating Range, and Zero Current Output Voltage (page 24), Functional Description Diagrams (pages 25-29), Definition of Operating and Performance Characteristics diagrams and equations (pages 30-32), Fault Behavior Diagrams (page 34), Response Characteristics Definitions and Performance Data section (pages 35-36), Application and Theory diagram (page 38), Thermal Performance diagram (page 40), and other minor editorial updates.
5	June 24, 2021	UVD functionality disabled (all pages); updated part numbers (pages 2, 11-14, 19); updated Isolation and Package Characteristics tables (page 5)
6	September 14, 2021	Updated part numbering schematic (page 2) and other minor editorial updates (pages 2, 4, 9, 38)
7	November 10, 2021	Removed footnote 4 (page 2); updated Power Supply Offset Error (page 9), Total Error and Total Error Components and Total Error and Total Error Components Including Lifetime Drifts values and footnotes (pages 21-24); updated Total Output Error equation (page 30), and package drawing (page 40).
8	January 19, 2024	Added Thermal Characteristics (page 4); updated MA and LA Isolation Characteristics tables (page 5); removed Output Drive characteristic (page 9); added mean ± 3 sigma values to Performance Characteristics tables (pages 11-24); updated Selection Guide (page 2); removed Maximum Continuous Current from Absolute Maximum Ratings table (page 3); minor editorial updates (all pages)

Copyright 2024, Allegro MicroSystems.

Allegro MicroSystems reserves the right to make, from time to time, such departures from the detail specifications as may be required to permit improvements in the performance, reliability, or manufacturability of its products. Before placing an order, the user is cautioned to verify that the information being relied upon is current.

Allegro's products are not to be used in any devices or systems, including but not limited to life support devices or systems, in which a failure of Allegro's product can reasonably be expected to cause bodily harm.

The information included herein is believed to be accurate and reliable. However, Allegro MicroSystems assumes no responsibility for its use; nor for any infringement of patents or other rights of third parties which may result from its use.

Copies of this document are considered uncontrolled documents.

For the latest version of this document, visit our website:

www.allegromicro.com

Looking for pricing, stock, or lifecycle information?

Click below to explore more details on WIN SOURCE:

- ⊖ [View ACS37002LMABTR-050B5 on WIN SOURCE](#)
- ⊖ [Allegro MicroSystems, LLC Information](#)

Optimize Your Supply Chain with WIN SOURCE Solutions

- ✓ Global Sourcing Solution
- ✓ Obsolete Management
- ✓ Cost Control Management
- ✓ Shortage Management
- ✓ Alternative Solution
- ✓ Excess Inventory Management