

Product Summary

Device	BV _{DSS}	R _{DS(ON)} Max	I _D Max T _A = +25°C
Q1	20V	0.99Ω @ V _{GS} = 4.5V	450mA
		1.2Ω @ V _{GS} = 2.5V	400mA
		1.8Ω @ V _{GS} = 1.8V	330mA
		2.4Ω @ V _{GS} = 1.5V	300mA
Q2	-20V	1.9Ω @ V _{GS} = -4.5V	-310mA
		2.4Ω @ V _{GS} = -2.5V	-280mA
		3.4Ω @ V _{GS} = -1.8V	-240mA
		5Ω @ V _{GS} = -1.5V	-180mA

Features and Benefits

- Low On-Resistance
- Very Low Gate Threshold Voltage, 1.0V Max
- Low Input Capacitance
- Fast Switching Speed
- Ultra-Small Surface Mount Package 1mm x 1mm
- Low Package Profile, 0.45mm Maximum Package Height
- ESD Protected Gate
- **Totally Lead-Free & Fully RoHS Compliant (Note 1 & 2)**
- **Halogen and Antimony Free. "Green" Device (Note 3)**
- **Qualified to AEC-Q101 Standards for High Reliability**
- **PPAP Capable (Note 4)**

Description and Applications

This MOSFET is designed to meet the stringent requirements of Automotive applications. It is qualified to AEC-Q101, supported by a PPAP and is ideal for use in:

- General Purpose Interfacing Switch
- Power Management Functions
- Analog Switch

Mechanical Data

- Case: SOT963
- Case Material: Molded Plastic, "Green" Molding Compound.
UL Flammability Classification Rating 94V-0
- Moisture Sensitivity: Level 1 per J-STD-020
- Terminal Connections Indicator: See Diagram
- Terminals: Finish — Matte Tin Annealed over Copper Leadframe.
Solderable per MIL-STD-202, Method 208 **e3**
- Weight: 0.027 grams (Approximate)



SOT963

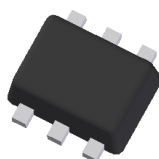

Top View

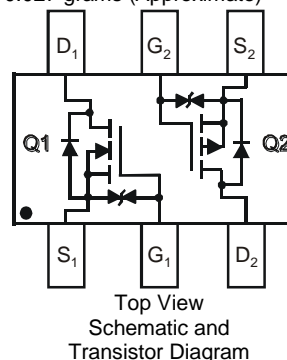

Ordering Information (Note 5)

Part Number	Case	Packaging
DMC2990UDJQ-7	SOT963	10K/Tape & Reel
DMC2990UDJQ-7B	SOT963	10K/Tape & Reel

- Notes:
1. No purposely added lead. Fully EU Directive 2002/95/EC (RoHS) & 2011/65/EU (RoHS 2) compliant.
 2. See http://www.diodes.com/quality/lead_free.html for more information about Diodes Incorporated's definitions of Halogen- and Antimony-free, "Green" and Lead-free.
 3. Halogen- and Antimony-free "Green" products are defined as those which contain <900ppm bromine, <900ppm chlorine (<1500ppm total Br + Cl) and <1000ppm antimony compounds.
 4. Automotive products are AEC-Q101 qualified and are PPAP capable. Refer to http://www.diodes.com/product_compliance_definitions.html.
 5. For packaging details, go to our website at <http://www.diodes.com/products/packages.html>.

Marking Information

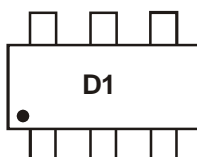

D1 = Product Type Marking Code

Maximum Ratings Q1 N-CHANNEL (@ $T_A = +25^\circ\text{C}$, unless otherwise specified.)

Characteristic			Symbol	Value	Unit
Drain-Source Voltage			V_{DSS}	20	V
Gate-Source Voltage			V_{GSS}	± 8	V
Continuous Drain Current (Note 6) $V_{GS} = 4.5\text{V}$	Steady State	$T_A = +25^\circ\text{C}$ $T_A = +70^\circ\text{C}$	I_D	450 350	mA
	t<5s	$T_A = +25^\circ\text{C}$ $T_A = +70^\circ\text{C}$	I_D	520 410	mA
Continuous Drain Current (Note 6) $V_{GS} = 1.8\text{V}$	Steady State	$T_A = +25^\circ\text{C}$ $T_A = +70^\circ\text{C}$	I_D	330 260	mA
	t<5s	$T_A = +25^\circ\text{C}$ $T_A = +70^\circ\text{C}$	I_D	390 310	mA
Maximum Continuous Body Diode Forward Current (Note 6)			I_S	440	mA
Pulsed Drain Current (Note 7)			I_{DM}	800	mA

Maximum Ratings Q2 P-CHANNEL (@ $T_A = +25^\circ\text{C}$, unless otherwise specified.)

Characteristic			Symbol	Value	Unit
Drain-Source Voltage			V_{DSS}	-20	V
Gate-Source Voltage			V_{GSS}	± 8	V
Continuous Drain Current (Note 6) $V_{GS} = -4.5\text{V}$	Steady State	$T_A = +25^\circ\text{C}$ $T_A = +70^\circ\text{C}$	I_D	-310 -240	mA
	t<5s	$T_A = +25^\circ\text{C}$ $T_A = +70^\circ\text{C}$	I_D	-360 -280	mA
Continuous Drain Current (Note 6) $V_{GS} = -1.8\text{V}$	Steady State	$T_A = +25^\circ\text{C}$ $T_A = +70^\circ\text{C}$	I_D	-240 -190	mA
	t<5s	$T_A = +25^\circ\text{C}$ $T_A = +70^\circ\text{C}$	I_D	-280 -220	mA
Maximum Continuous Body Diode Forward Current (Note 6)			I_S	-440	mA
Pulsed Drain Current (Note 7)			I_{DM}	-800	mA

Thermal Characteristics (@ $T_A = +25^\circ\text{C}$, unless otherwise specified.)

Characteristic		Symbol	Value	Unit
Total Power Dissipation (Note 6)		P_D	350	mW
Thermal Resistance, Junction to Ambient (Note 6)	Steady State	$R_{\theta JA}$	360	$^\circ\text{C/W}$
	t<5s		270	$^\circ\text{C/W}$
Operating and Storage Temperature Range		T_J, T_{STG}	-55 to +150	$^\circ\text{C}$

- Notes: 6. Device mounted on FR-4 PCB, with minimum recommended pad layout.
7. Device mounted on minimum recommended pad layout test board, 10 μs pulse duty cycle = 1%.

Electrical Characteristics Q1 N-CHANNEL (@T_A = +25°C, unless otherwise specified.)

Characteristic	Symbol	Min	Typ	Max	Unit	Test Condition
OFF CHARACTERISTICS (Note 8)						
Drain-Source Breakdown Voltage	BV _{DSS}	20	-	-	V	V _{GS} = 0V, I _D = 250μA
Zero Gate Voltage Drain Current	I _{DSS}	-	-	100	nA	V _{DS} = 16V, V _{GS} = 0V
		-	-	50		V _{DS} = 5V, V _{GS} = 0V
Gate-Source Leakage	I _{GSS}	-	-	±100	nA	V _{GS} = ±5V, V _{DS} = 0V
ON CHARACTERISTICS (Note 8)						
Gate Threshold Voltage	V _{GS(TH)}	0.4	-	1.0	V	V _{DS} = V _{GS} , I _D = 250μA
Static Drain-Source On-Resistance	R _{DS(ON)}	-	0.60	0.99	Ω	V _{GS} = 4.5V, I _D = 100mA
		-	0.75	1.2		V _{GS} = 2.5V, I _D = 50mA
		-	0.90	1.8		V _{GS} = 1.8V, I _D = 20mA
		-	1.2	2.4		V _{GS} = 1.5V, I _D = 10mA
		-	2.0	-		V _{GS} = 1.2V, I _D = 1mA
Forward Transfer Admittance	Y _{fs}	180	850	-	ms	V _{DS} = 5V, I _D = 125mA
Diode Forward Voltage	V _{SD}	-	0.6	1.0	V	V _{GS} = 0V, I _S = 10mA
DYNAMIC CHARACTERISTICS (Note 9)						
Input Capacitance	C _{iSS}	-	27.6	-	pF	V _{DS} = 15V, V _{GS} = 0V, f = 1.0MHz
Output Capacitance	C _{oSS}	-	4.0	-	pF	
Reverse Transfer Capacitance	C _{rSS}	-	2.8	-	pF	
Gate Resistance	R _g	-	113	-	Ω	V _{DS} = 0V, V _{GS} = 0V, f = 1.0MHz
Total Gate Charge	Q _g	-	0.5	-	nC	V _{GS} = 4.5V, V _{DS} = 10V, I _D = 250mA
Gate-Source Charge	Q _{gs}	-	0.07	-	nC	
Gate-Drain Charge	Q _{gd}	-	0.07	-	nC	
Turn-On Delay Time	t _{D(ON)}	-	4.0	-	ns	V _{DD} = 15V, V _{GS} = 4.5V, R _L = 47Ω, R _g = 2Ω, I _D = 200mA
Turn-On Rise Time	t _R	-	3.3	-	ns	
Turn-Off Delay Time	t _{D(OFF)}	-	19.0	-	ns	
Turn-Off Fall Time	t _F	-	6.4	-	ns	

Electrical Characteristics Q2 P-CHANNEL (@T_A = +25°C, unless otherwise specified.)

Characteristic	Symbol	Min	Typ	Max	Unit	Test Condition
OFF CHARACTERISTICS (Note 8)						
Drain-Source Breakdown Voltage	BV _{DSS}	-20	-	-	V	V _{GS} = 0V, I _D = -250μA
Zero Gate Voltage Drain Current	I _{DSS}	-	-	100	nA	V _{DS} = -16V, V _{GS} = 0V
		-	-	50		V _{DS} = -5V, V _{GS} = 0V
Gate-Source Leakage	I _{GSS}	-	-	±100	nA	V _{GS} = ±5V, V _{DS} = 0V
ON CHARACTERISTICS (Note 8)						
Gate Threshold Voltage	V _{GS(TH)}	-0.4	-	-1.0	V	V _{DS} = V _{GS} , I _D = -250μA
Static Drain-Source On-Resistance	R _{DS(ON)}	-	1.2	1.9	Ω	V _{GS} = -4.5V, I _D = -100mA
		-	1.5	2.4		V _{GS} = -2.5V, I _D = -50mA
		-	2.1	3.4		V _{GS} = -1.8V, I _D = -20mA
		-	2.5	5		V _{GS} = -1.5V, I _D = -10mA
		-	4.0	-		V _{GS} = -1.2V, I _D = -1mA
Forward Transfer Admittance	Y _{fs}	100	450	-	ms	V _{DS} = -5V, I _D = -125mA
Diode Forward Voltage	V _{SD}	-	-0.6	-1.0	V	V _{GS} = 0V, I _S = -10mA
DYNAMIC CHARACTERISTICS (Note 9)						
Input Capacitance	C _{iSS}	-	28.7	-	pF	V _{DS} = -15V, V _{GS} = 0V, f = 1.0MHz
Output Capacitance	C _{oSS}	-	4.2	-	pF	
Reverse Transfer Capacitance	C _{rSS}	-	2.9	-	pF	
Gate Resistance	R _g	-	399	-	Ω	V _{DS} = 0V, V _{GS} = 0V, f = 1.0MHz
Total Gate Charge	Q _g	-	0.4	-	nC	V _{GS} = -4.5V, V _{DS} = -10V, I _D = -250mA
Gate-Source Charge	Q _{gs}	-	0.08	-	nC	
Gate-Drain Charge	Q _{gd}	-	0.06	-	nC	
Turn-On Delay Time	t _{D(ON)}	-	5.8	-	ns	V _{DD} = -15V, V _{GS} = -4.5V, R _g = 2Ω, I _D = -200mA
Turn-On Rise Time	t _R	-	5.7	-	ns	
Turn-Off Delay Time	t _{D(OFF)}	-	31.1	-	ns	
Turn-Off Fall Time	t _F	-	16.4	-	ns	

Notes: 8. Short duration pulse test used to minimize self-heating effect.
9. Guaranteed by design. Not subject to product testing.

Typical Characteristics - N-CHANNEL

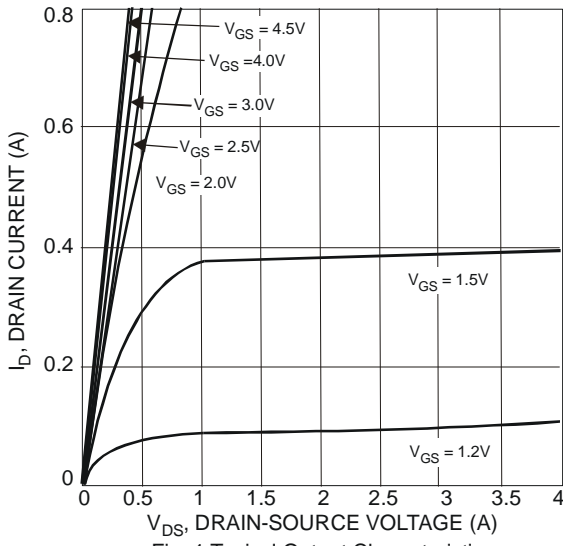

Fig. 1 Typical Output Characteristics

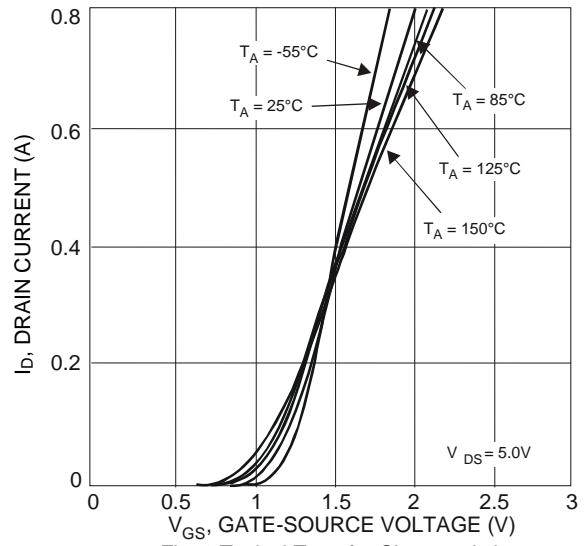

Fig. 2 Typical Transfer Characteristics

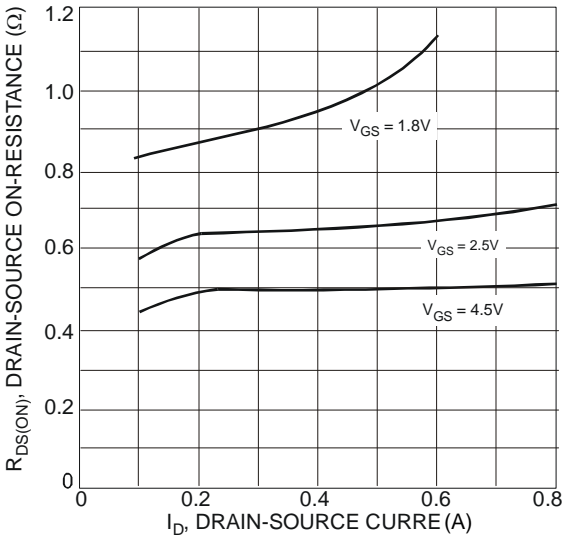

Fig. 3 Typical On-Resistance vs. Drain Current and Gate Voltage

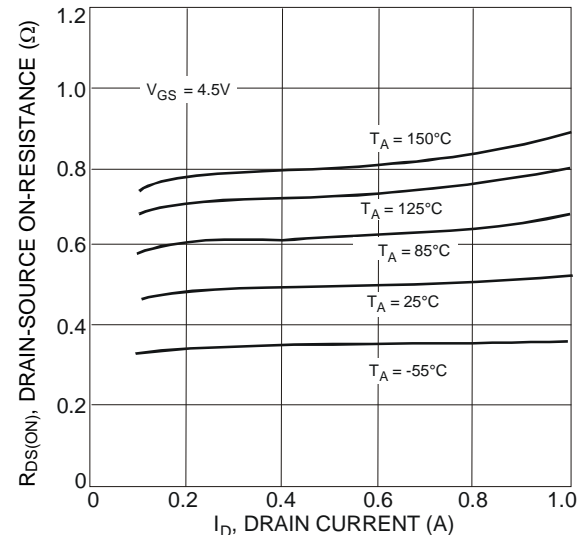

Fig. 4 Typical On-Resistance vs. Drain Current and Temperature

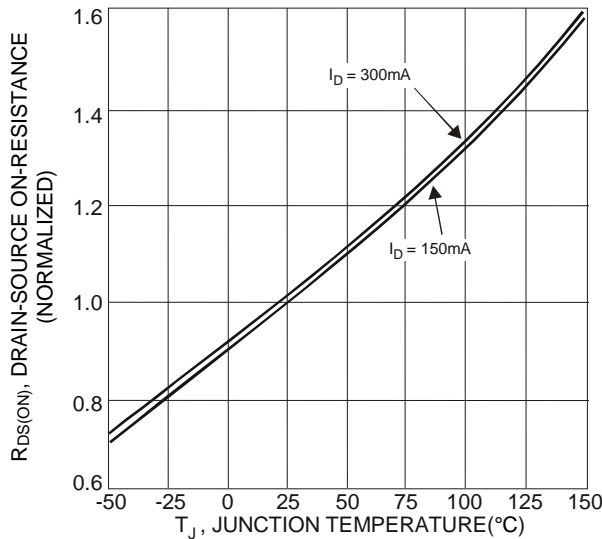

Fig. 5 On-Resistance Variation with Temperature

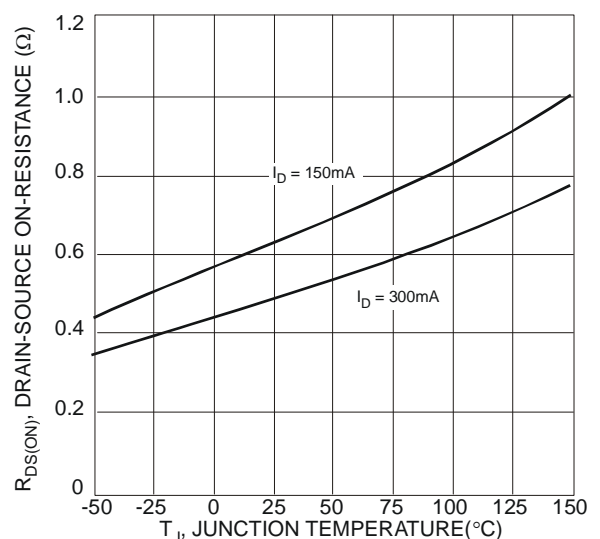

Fig. 6 On-Resistance Variation with Temperature

Typical Characteristics - N-CHANNEL (Cont.)

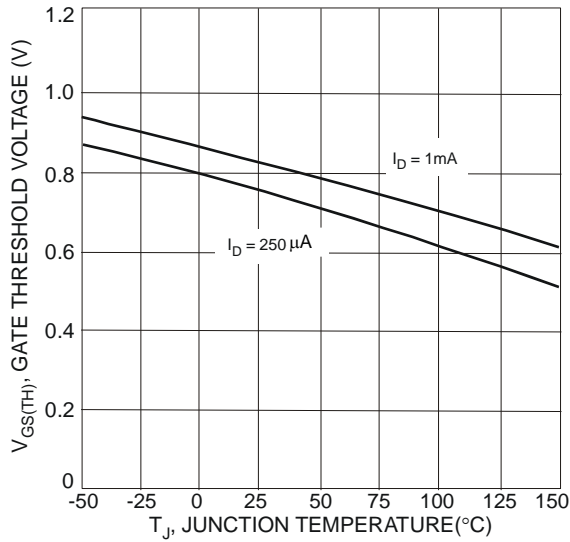

Fig. 7 Gate Threshold Variation vs. Ambient Temperature

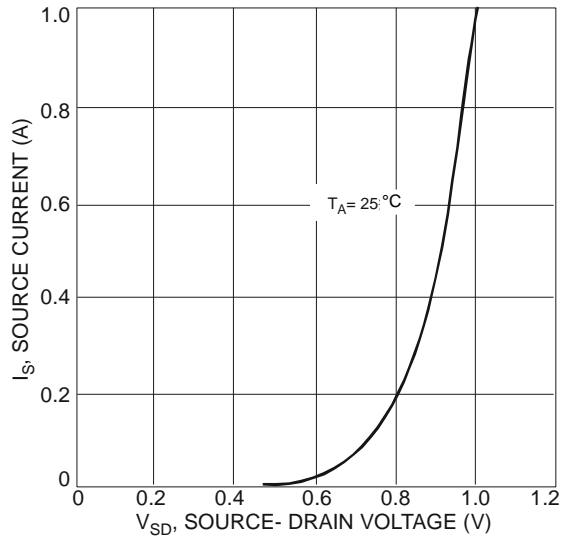

Fig. 8 Diodes Forward Voltage vs. Current

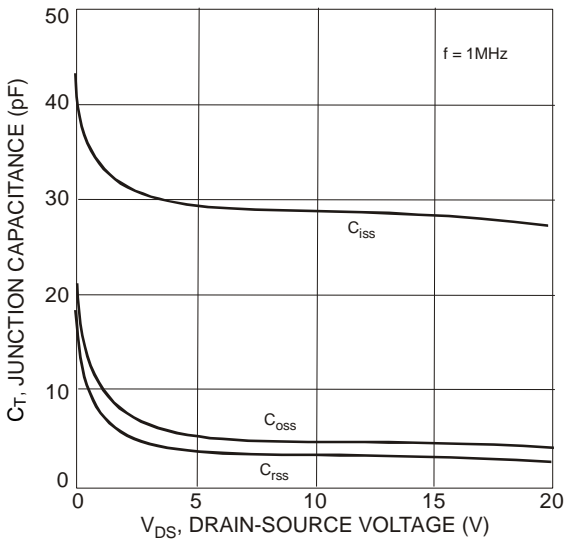

Fig. 9 Typical Junction Capacitance

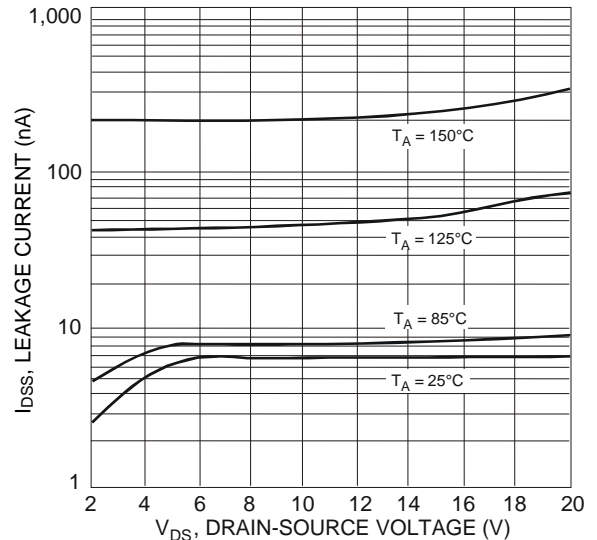

Fig. 10 Typical Drain-Source Leakage Current vs. Voltage

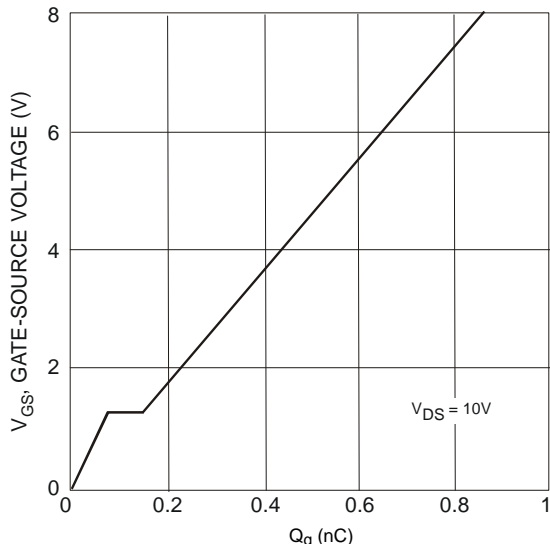

Fig. 11 Gate Charge Characteristics

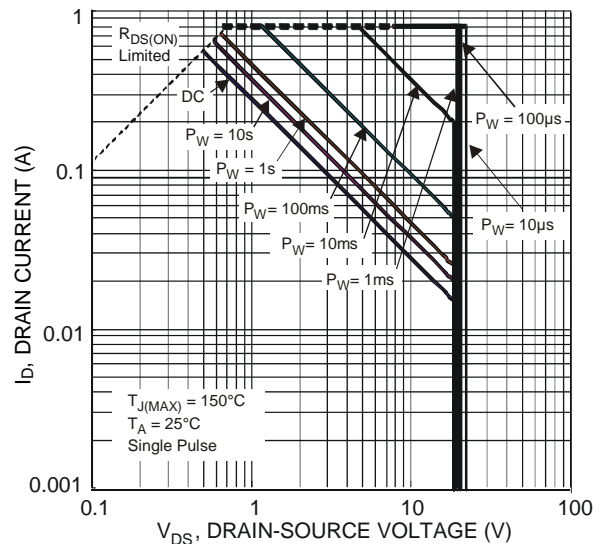

Fig. 12 SOA, Safe Operation Area

Typical Characteristics - P-CHANNEL

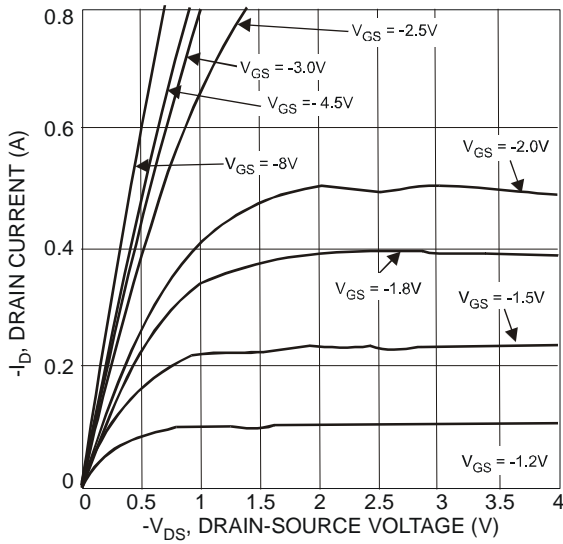

Fig. 13 Typical Output Characteristics

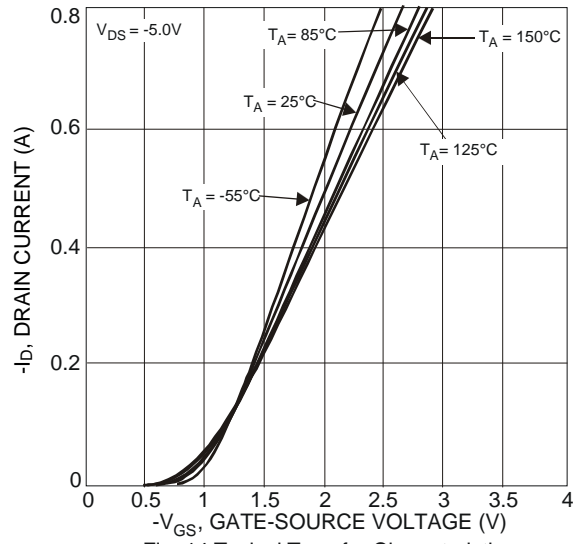

Fig. 14 Typical Transfer Characteristics

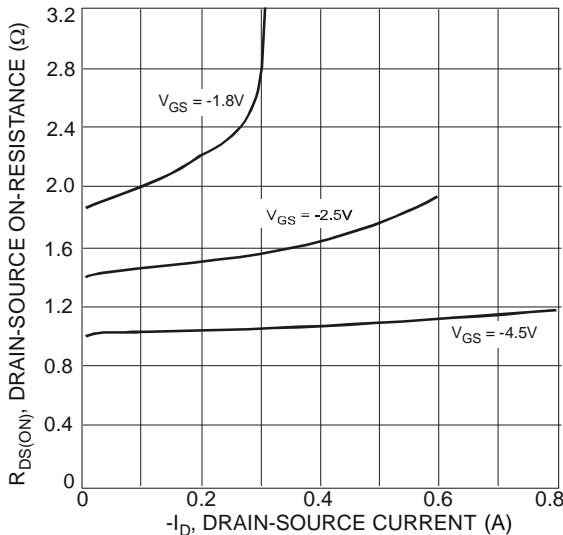

Fig. 15 Typical On-Resistance vs. Drain Current and Gate Voltage

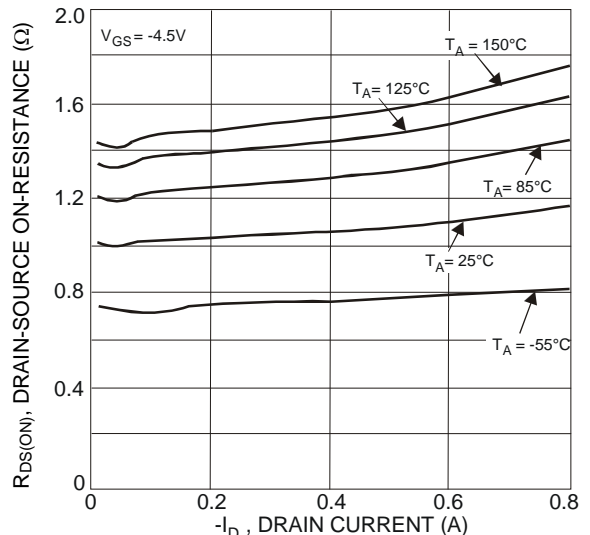

Fig. 16 Typical On-Resistance vs. Drain Current and Temperature

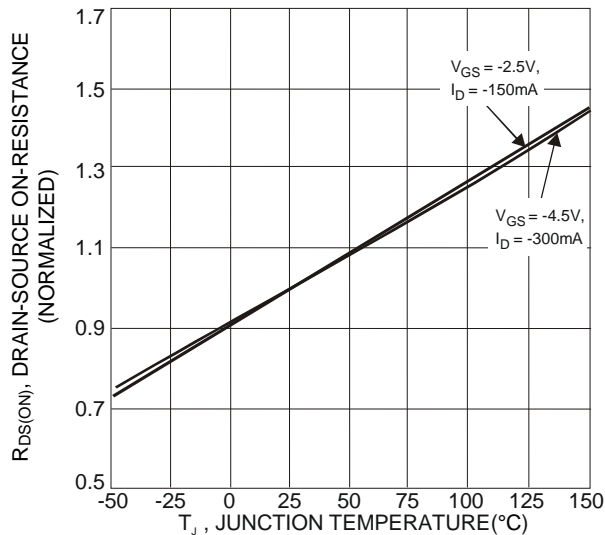

Fig. 17 On-Resistance Variation with Temperature

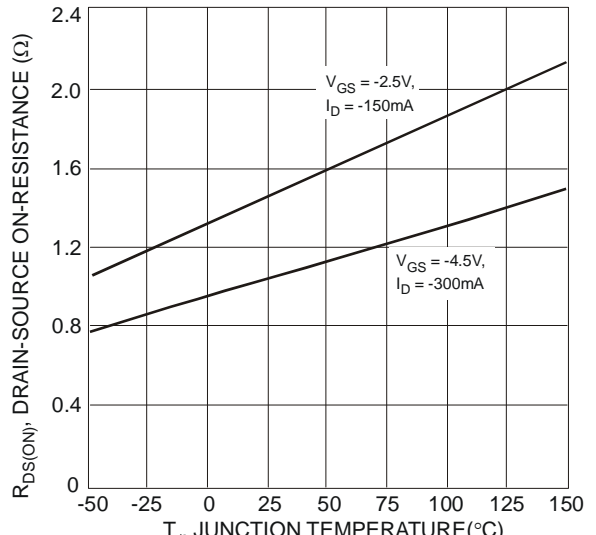

Fig. 18 On-Resistance Variation with Temperature

Typical Characteristics - P-CHANNEL (Cont.)

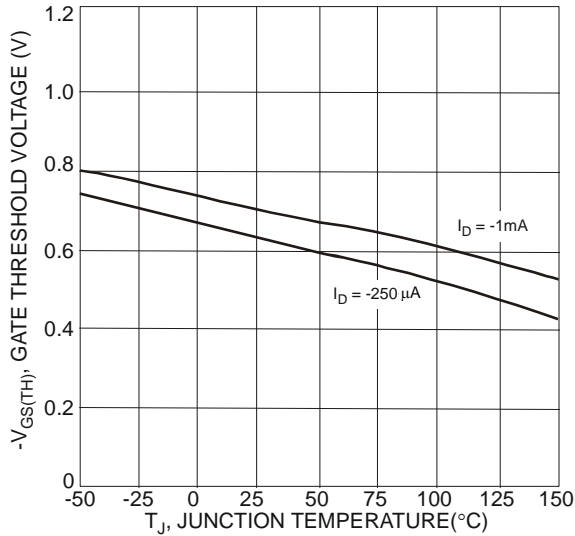

Fig. 19 Gate Threshold Variation vs. Ambient Temperature

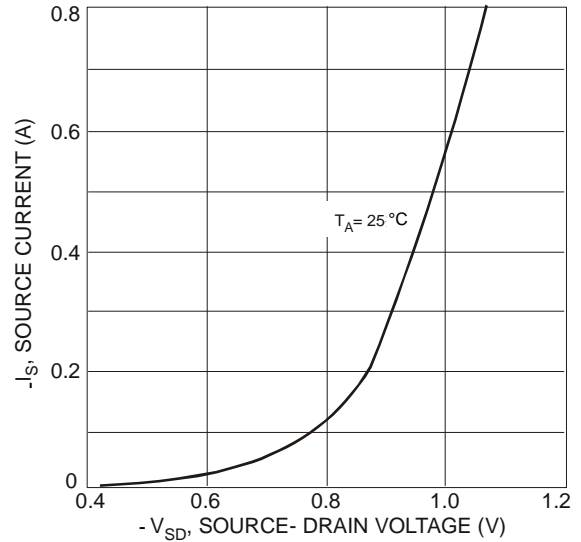

Fig. 20 Diodes Forward Voltage vs. Current

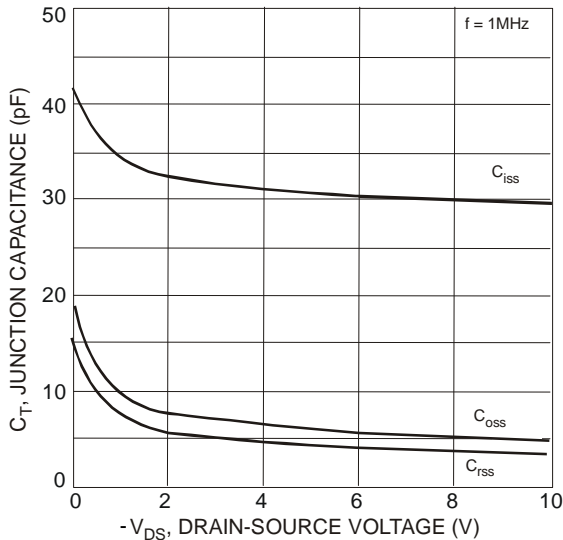

Fig. 21 Typical Junction Capacitance

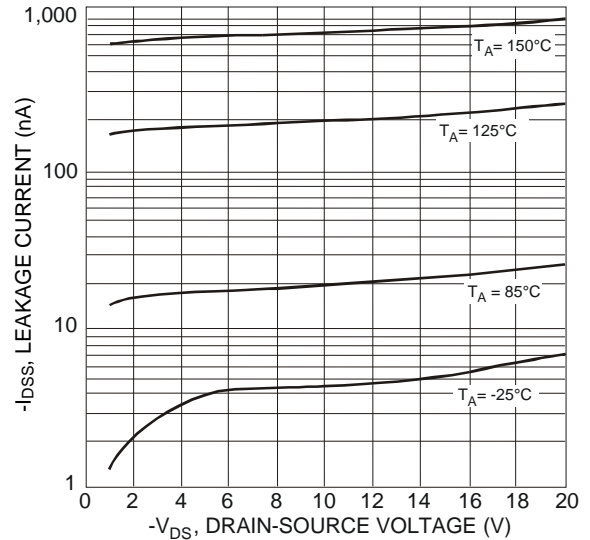

Fig. 22 Typical Leakage Current vs. Drain-Source Voltage

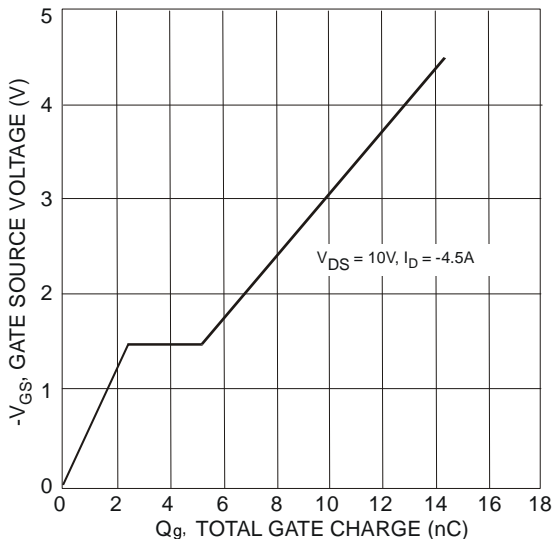

Fig. 23 Gate Charge Characteristics

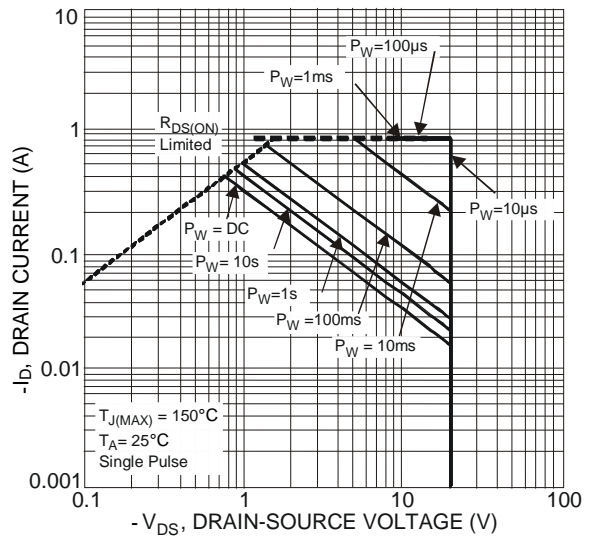
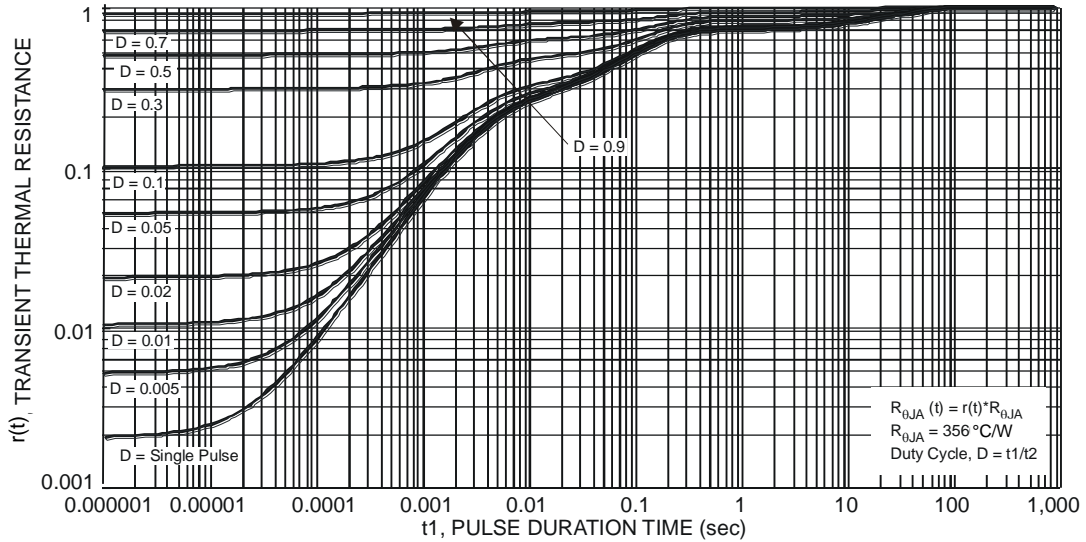

Fig. 24 SOA, Safe Operation Area



Package Outline Dimensions

Please see <http://www.diodes.com/package-outlines.html> for the latest version.

SOT963

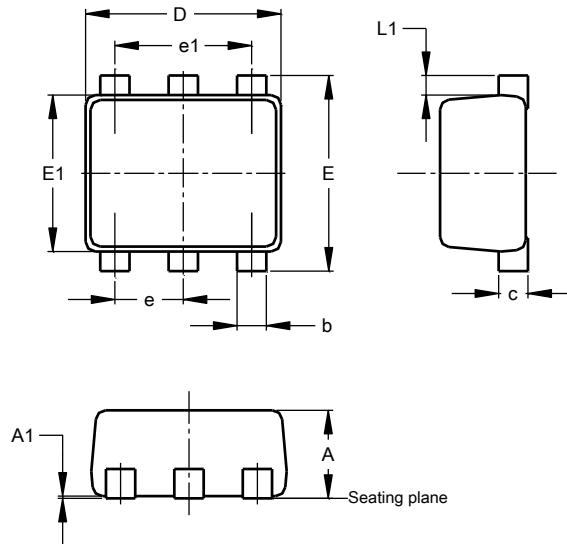

SOT963			
Dim	Min	Max	Typ
A	0.40	0.50	0.45
A1	0.00	0.05	--
b	0.10	0.20	0.15
c	0.120	0.180	0.150
D	0.95	1.05	1.00
E	0.95	1.05	1.00
E1	0.75	0.85	0.80
e	--	--	0.35
e1	--	--	0.70
L1	0.05	0.15	0.10
All Dimensions in mm			

Suggested Pad Layout

Please see <http://www.diodes.com/package-outlines.html> for the latest version.
SOT963

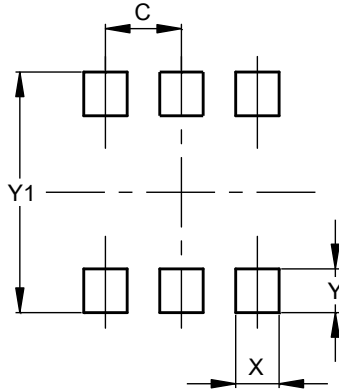

Dimensions	Value (in mm)
C	0.350
X	0.200
Y	0.200
Y1	1.100

IMPORTANT NOTICE

DIODES INCORPORATED MAKES NO WARRANTY OF ANY KIND, EXPRESS OR IMPLIED, WITH REGARDS TO THIS DOCUMENT, INCLUDING, BUT NOT LIMITED TO, THE IMPLIED WARRANTIES OF MERCHANTABILITY AND FITNESS FOR A PARTICULAR PURPOSE (AND THEIR EQUIVALENTS UNDER THE LAWS OF ANY JURISDICTION).

Diodes Incorporated and its subsidiaries reserve the right to make modifications, enhancements, improvements, corrections or other changes without further notice to this document and any product described herein. Diodes Incorporated does not assume any liability arising out of the application or use of this document or any product described herein; neither does Diodes Incorporated convey any license under its patent or trademark rights, nor the rights of others. Any Customer or user of this document or products described herein in such applications shall assume all risks of such use and will agree to hold Diodes Incorporated and all the companies whose products are represented on Diodes Incorporated website, harmless against all damages.

Diodes Incorporated does not warrant or accept any liability whatsoever in respect of any products purchased through unauthorized sales channel. Should Customers purchase or use Diodes Incorporated products for any unintended or unauthorized application, Customers shall indemnify and hold Diodes Incorporated and its representatives harmless against all claims, damages, expenses, and attorney fees arising out of, directly or indirectly, any claim of personal injury or death associated with such unintended or unauthorized application.

Products described herein may be covered by one or more United States, international or foreign patents pending. Product names and markings noted herein may also be covered by one or more United States, international or foreign trademarks.

This document is written in English but may be translated into multiple languages for reference. Only the English version of this document is the final and determinative format released by Diodes Incorporated.

LIFE SUPPORT

Diodes Incorporated products are specifically not authorized for use as critical components in life support devices or systems without the express written approval of the Chief Executive Officer of Diodes Incorporated. As used herein:

A. Life support devices or systems are devices or systems which:

1. are intended to implant into the body, or
2. support or sustain life and whose failure to perform when properly used in accordance with instructions for use provided in the labeling can be reasonably expected to result in significant injury to the user.

B. A critical component is any component in a life support device or system whose failure to perform can be reasonably expected to cause the failure of the life support device or to affect its safety or effectiveness.

Customers represent that they have all necessary expertise in the safety and regulatory ramifications of their life support devices or systems, and acknowledge and agree that they are solely responsible for all legal, regulatory and safety-related requirements concerning their products and any use of Diodes Incorporated products in such safety-critical, life support devices or systems, notwithstanding any devices- or systems-related information or support that may be provided by Diodes Incorporated. Further, Customers must fully indemnify Diodes Incorporated and its representatives against any damages arising out of the use of Diodes Incorporated products in such safety-critical, life support devices or systems.

Copyright © 2016, Diodes Incorporated

www.diodes.com

Looking for pricing, stock, or lifecycle information?

Click below to explore more details on WIN SOURCE:

 [View DMC2990UDJQ-7 on WIN SOURCE](#)

 [Diodes Incorporated](#) Information

Optimize Your Supply Chain with WIN SOURCE Solutions

-  Global Sourcing Solution
-  Obsolete Management
-  Cost Control Management
-  Shortage Management
-  Alternative Solution
-  Excess Inventory Management