



**THE DATASHEET OF
AISC-0402-12NJ-T**



Ceramic Wire Wound Inductors

AISC-0402



RoHS / RoHS II Compliant



1.19 x 0.64 x 0.66mm

FEATURES:

- Exceptional high Q and SRF for high frequency applications
- Excellent DCR and current carrying characteristics
- Small size suitable for surface mounting
- Epoxy coating protects wound wire

APPLICATIONS:

- Widely applied in mobile phones such as GSM, CDMA, PDC, etc.
- Bluetooth, W-LAN, Broadband Network
- High Frequency Communication Circuits
- Video cameras, liquid crystal television, and other electronic devices

ELECTRICAL SPECIFICATIONS:

Part Number	L (nH)	Tolerance	Q Min	L/Q Test Freq (MHz)	SRF Min (MHz)	RDC Max (Ω)	IDC Max (mA)
1N0	1.0	S	13	250	12700	0.045	1360
1N2	1.2	K, S	13	250	12000	0.060	1300
1N8	1.8	J, K, S	13	250	11500	0.070	1040
1N9	1.9	J, K, S	16	250	11300	0.070	1040
2N0	2.0	J, K, S	16	250	11100	0.070	1040
2N2	2.2	J, K, S	18	250	10800	0.070	960
2N4	2.4	J, K, S	18	250	10500	0.070	960
2N7	2.7	K, S	13	250	10400	0.120	640
3N0	3.0	J, K, S	20	250	7000	0.066	840
3N3	3.3	G, J, K, S	20	250	7000	0.066	840
3N6	3.6	G, J, K, S	20	250	6800	0.066	840
3N9	3.9	G, J, K, S	20	250	6000	0.066	840
4N3	4.3	G, J, K, S	20	250	6000	0.091	700
4N7	4.7	G, J, K, S	20	250	4775	0.083	800
5N1	5.1	G, J, K, S	23	250	5800	0.083	800
5N6	5.6	G, J, K, S	23	250	5800	0.083	760
6N2	6.2	G, J, K, S	23	250	5800	0.083	760
6N8	6.8	G, J, K	20	250	5800	0.083	680
7N3	7.3	G, J, K	25	250	6000	0.130	570
7N5	7.5	G, J, K	25	250	5800	0.100	680
8N2	8.2	G, J, K	25	250	4400	0.100	680
8N7	8.7	G, J, K	25	250	4200	0.100	680
9N0	9.0	G, J, K	25	250	4160	0.100	680
9N5	9.5	G, J, K	21	250	4000	0.162	600
10N	10	G, J, K	21	250	3900	0.200	480
11N	11	G, J, K	26	250	3680	0.120	640
12N	12	G, J, K	26	250	3600	0.120	640
13N	13	G, J, K	26	250	3450	0.185	440
15N	15	G, J, K	26	250	3280	0.170	560
16N	16	G, J, K	26	250	3100	0.220	560
18N	18	G, J, K	26	250	3100	0.230	480
19N	19	G, J, K	26	250	3040	0.200	480
20N	20	G, J, K	26	250	3000	0.250	420
22N	22	G, J, K	26	250	2800	0.250	400

Ceramic Wire Wound Inductors

AISC-0402



RoHS / RoHS II Compliant



1.19 x 0.64 x 0.66mm

Key Electrical Specifications (Cont.)

Part Number	L (nH)	Tolerance	Q Min	L/Q Test Freq (MHz)	SRF Min (MHz)	RDC Max (Ω)	IDC Max (mA)
23N	23	G, J, K	26	250	2720	0.250	400
24N	24	G, J, K	26	250	2700	0.300	400
27N	27	G, J, K	26	250	2480	0.300	400
30N	30	G, J, K	25	250	2350	0.300	400
33N	33	G, J, K	25	250	2350	0.350	400
36N	36	G, J, K	26	250	2320	0.400	320
39N	39	G, J, K	25	250	2100	0.500	200
40N	40	G, J, K	26	250	2240	0.550	200
43N	43	G, J, K	25	250	2030	0.700	150
47N	47	G, J, K	20	250	2100	0.750	150
51N	51	G, J, K	25	250	1750	0.820	100
56N	56	G, J, K	25	250	1760	0.970	100
62N	62	G, J, K	25	250	1620	0.970	100
68N	68	G, J, K	25	250	1620	1.120	100
72N	72	G, J, K	25	250	1620	1.550	100
82N	82	J, K	25	250	1620	1.550	100
R10	100	J, K	25	250	1620	2.600	100
R12	120	J, K	25	250	1520	2.700	90
R15	150	J, K	25	250	1200	2.900	80

Test Conditions:

Inductance (L): Agilent4287A+Agilent16197A or equivalent, 50mV

Direct Current Resistance (DCR): HIOKI 3540 or equivalent

Temperature rise current (Ir): Electric Power, Electric current meter, Thermometer

IDC: Based on temperature rise (ΔT : 20°C TYP.)

OPTIONS & PART IDENTIFICATION:



Ceramic Wire Wound Inductors

AISC-0402

 RoHS / RoHS II Compliant



1.19 x 0.64 x 0.66mm

MECHANICAL DIMENSIONS:



Recommended Land Pattern

A	B	C	D	E	H REF.	I REF.	J REF.
1.10±0.1	0.60±0.1	0.55±0.1	0.50±0.1	0.20±0.1	0.65	0.35	0.50

Materials

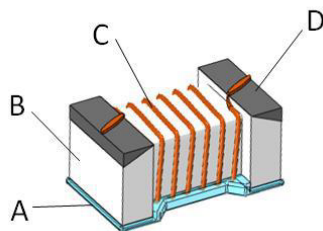

No.	Components	Material
A	Coating	Ultraviolet epoxy resin
B	Core	Ceramic
C	Wire	Polyurethane system enameled copper wire
D	Electrodes	Mo-Mn with Ni and Gold plating



1.19 x 0.64 x 0.66mm

REFLOW PROFILE:



- Δ 1~2 C/sec. Ramp
- Δ Pre-heating: 150~190°C/120±30 sec.
- Δ Time above 240°C: 20~60sec
- Δ Peak temperature: 260°C Max./10sec.
- Δ Solder paste: Sn/3.0Ag/0.5Cu
- Δ Max.2 times for re-flowing

Ceramic Wire Wound Inductors

AISC-0402



RoHS / RoHS II Compliant



1.19 x 0.64 x 0.66mm

TAPE & REEL:

T= tape and reel (10,000pcs/reel)



A	B	P	K	T
0.66±0.05	1.20±0.05	2.0±0.1	0.75±0.05	0.8±0.1

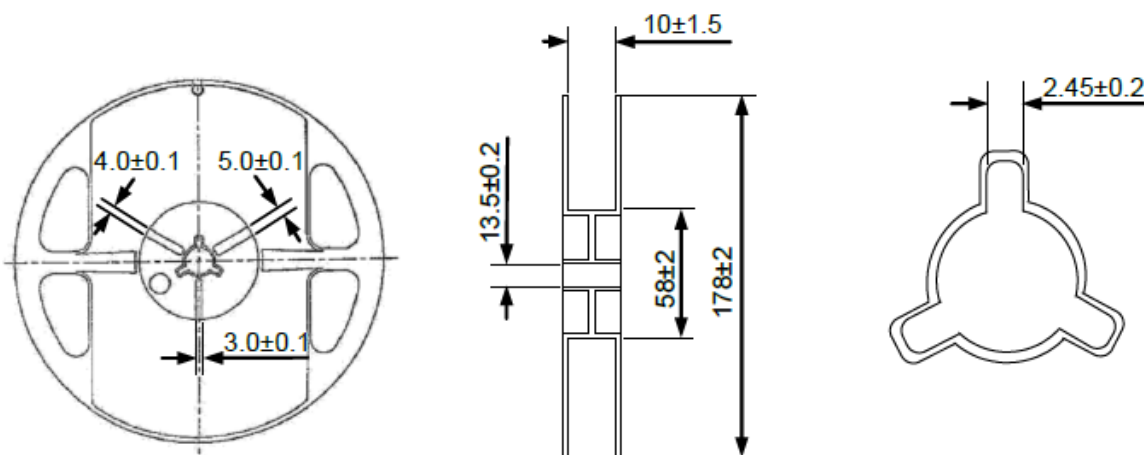

Dimension: mm

ATTENTION: Abracon LLC's products are COTS – Commercial-Off-The-Shelf products; suitable for Commercial, Industrial and, where designated, Automotive Applications. Abracon's products are not specifically designed for Military, Aviation, Aerospace, Life-dependent Medical applications or any application requiring high reliability where component failure could result in loss of life and/or property. For applications requiring high reliability and/or presenting an extreme operating environment, written consent and authorization from Abracon LLC is required. Please contact Abracon LLC for more information.



5101 Hidden Creek Ln Spicewood TX 78669
 Phone: 512-371-6159 | Fax: 512-351-8858
 For terms and conditions of sales, please visit:
www.abracon.com

REVISED: 1-21-21

ABRACON IS
 ISO9001-2015
 CERTIFIED

Looking for pricing, stock, or lifecycle information?

Click below to explore more details on WIN SOURCE:

 [View AISC-0402-12NJ-T on WIN SOURCE](#)

 [Abracon LLC Information](#)

Optimize Your Supply Chain with WIN SOURCE Solutions

-  Global Sourcing Solution
-  Obsolete Management
-  Cost Control Management
-  Shortage Management
-  Alternative Solution
-  Excess Inventory Management