



**THE DATASHEET OF
ACPDQC12V-HF**



ACPDQC12V-HF

High-Reliability and High-Performance

RoHS Device

Halogen Free



Features

- Bi-directional ESD protection.
- Surface mount package.
- Ultra small SMD package:0402C.
- High component density.
- AEC-Q101 Qualified.

Mechanical data

- Case: 0402C/SOD-923F standard package, molded plastic.
- Terminals: Gold plated, solderable per MIL-STD-750,method 2026.
- Mounting position: Any.
- Weight: 0.001 grams (approx.).

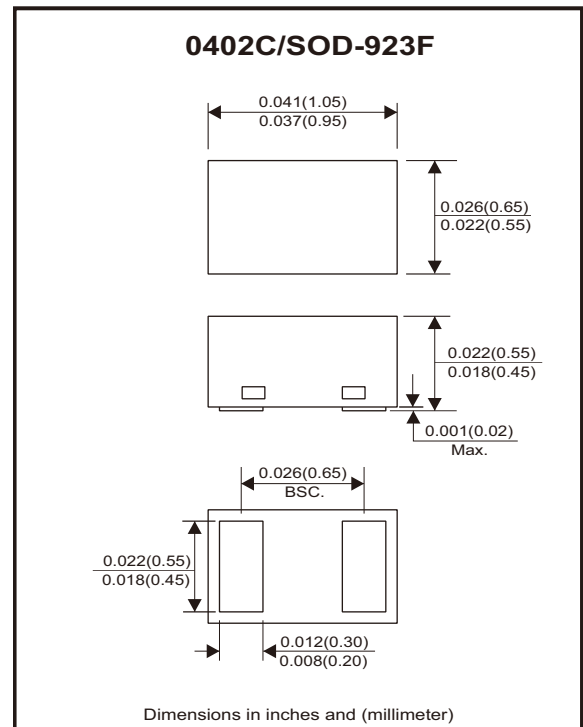

Circuit Diagram



Maximum Rating (at TA=25°C unless otherwise noted)

Parameter	Conditions	Symbol	Value	Unit
Peak pulse power	$T_P = 8/20\mu s$	P_{PP}	25	W
ESD capability	IEC 61000-4-2(air)	ESD	± 16	kV
	IEC 61000-4-2(contact)	ESD	± 8	
Operating temperature range		T_J	-40 ~ +125	°C
Storage temperature range		T_{STG}	-55 ~ +150	°C

Electrical Characteristics (at TA=25°C unless otherwise noted)

Parameter	Conditions	Symbol	Min	Typ	Max	Unit
Diode breakdown voltage	$I_R = 1mA$	V_{BR}	13	17		V
Leakage current	$V_R = 12V$	I_L		0.1	2.0	μA
Clamping voltage	$I_{PP} = 1A, T_P = 8/20\mu s$	V_C			25	V
Junction capacitance	$V_R = 0V, f = 1MHz$	C_T		12		pF

Rating and Characteristic Curves (ACPDQC12V-HF)

Fig.1 - 8/20 μ s Peak Pulse Current
Wave Form Acc. IEC 61000-4-5

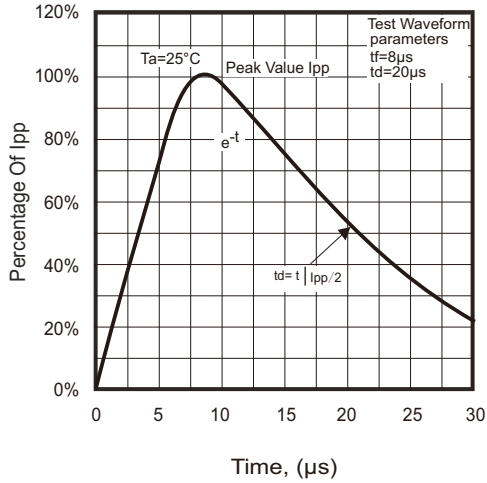

Fig.2 - Reverse Characteristics

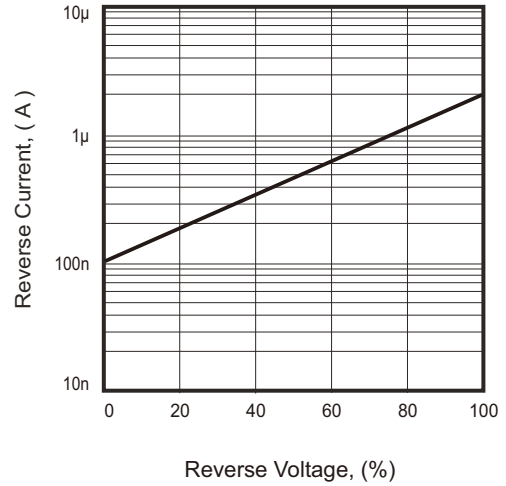

Fig.3 - Capacitance Between
Terminals Characteristics

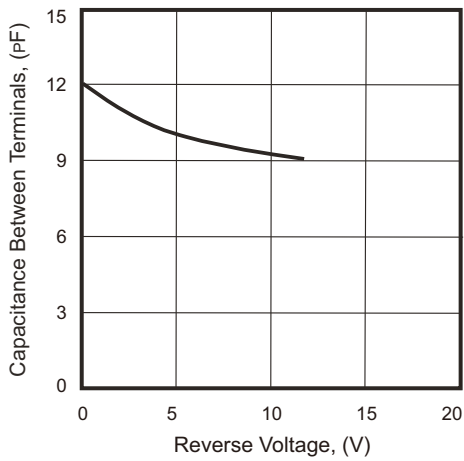
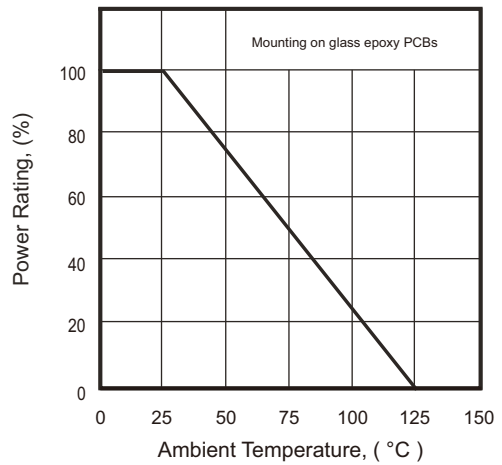
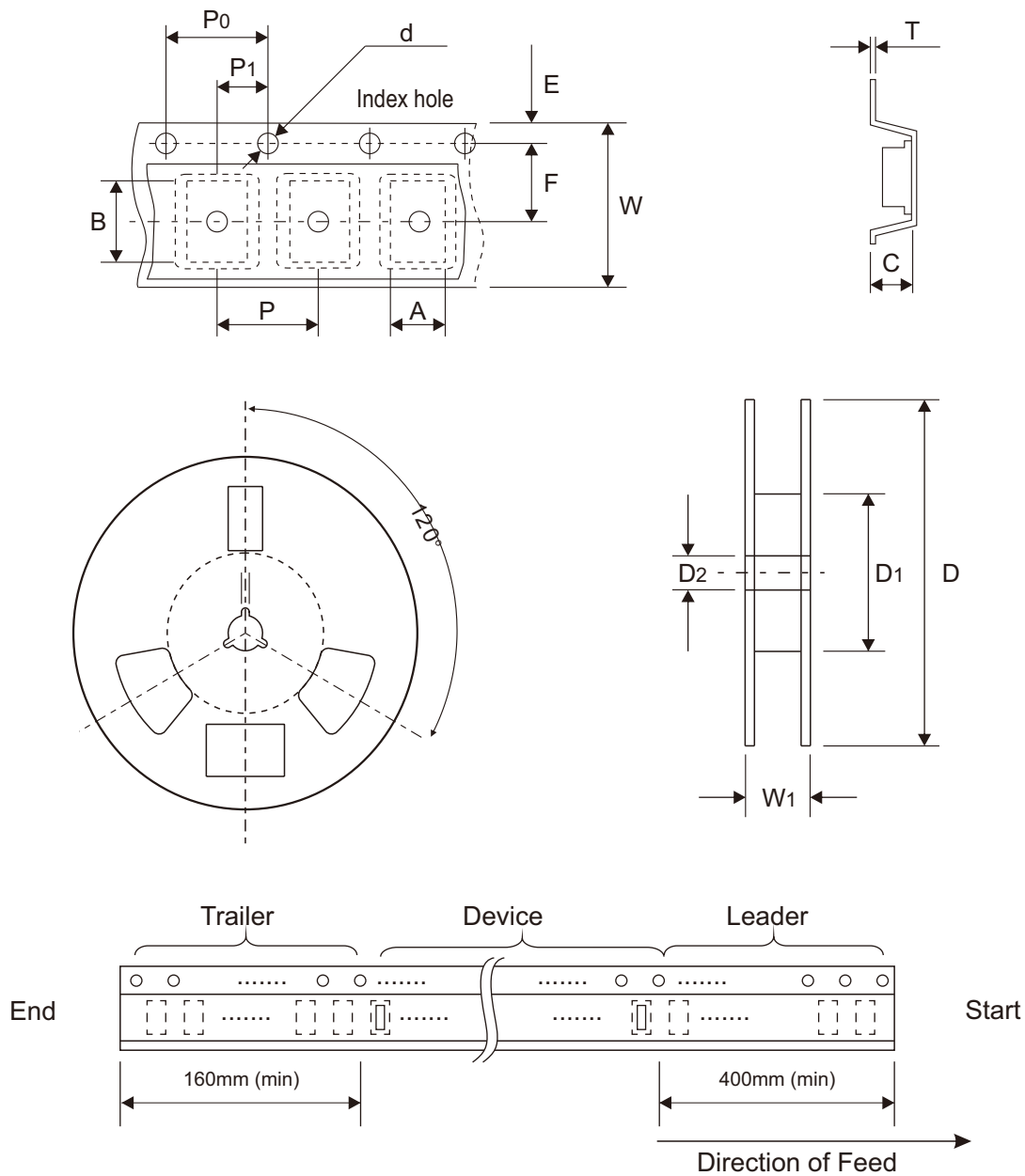

Fig.4 - Power Rating Derating Curve



Reel Taping Specification



0402C (SOD-923F)	SYMBOL	A	B	C	d	D	D1	D2
	(mm)	0.75 ± 0.05	1.17 ± 0.05	0.65 ± 0.05	1.50 + 0.10 - 0.00	178.00 ± 1.00	60.00 ± 0.50	13.50 ± 0.20
	(inch)	0.030 ± 0.002	0.046 ± 0.002	0.026 ± 0.002	0.059 + 0.004 - 0.000	7.008 ± 0.039	2.362 ± 0.020	0.531 ± 0.008

0402C (SOD-923F)	SYMBOL	E	F	P	P0	P1	T	W	W1
	(mm)	1.75 ± 0.10	3.50 ± 0.10	4.00 ± 0.10	4.00 ± 0.10	2.00 ± 0.10	0.20 + 0.02 - 0.05	8.00 ± 0.20	12.00 + 0.50 - 0.00
	(inch)	0.069 ± 0.004	0.138 ± 0.004	0.157 ± 0.004	0.157 ± 0.004	0.079 ± 0.004	0.008 + 0.001 - 0.002	0.315 ± 0.008	0.472 + 0.020 - 0.000

Marking Code

Part Number	Marking Code
ACPDQC12V-HF	E2



Product type marking code

Suggested P.C.B. PAD Layout

SIZE	0402C/SOD-923F	
	(mm)	(inch)
A	0.70	0.028
B	0.40	0.016
C	0.60	0.024
D	1.10	0.043
E	0.30	0.012

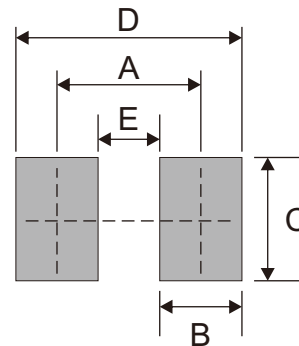

Standard Packaging

Case Type	REEL PACK	
	REEL (pcs)	Reel Size (inch)
0402C/SOD-923F	5,000	7

Looking for pricing, stock, or lifecycle information?

Click below to explore more details on WIN SOURCE:

- ⊖ [View ACPDQC12V-HF](#) on WIN SOURCE
- ⊖ [Comchip Technology](#) Information

Optimize Your Supply Chain with WIN SOURCE Solutions

- ✓ Global Sourcing Solution
- ✓ Obsolete Management
- ✓ Cost Control Management
- ✓ Shortage Management
- ✓ Alternative Solution
- ✓ Excess Inventory Management