



**THE DATASHEET OF
SWPA5020S680MT**



绕线贴片功率电感—SWPA 系列

Wire Wound SMD Power Inductors – SWPA Series

Operating temperature range: -40°C~+125°C (Including self-heating)



特征

- 磁性胶水涂敷结构极大减少了蜂鸣声
- 在磁芯上金属化电极，抗跌落冲击强，经久耐用
- 闭合磁路结构设计，漏磁少，抗 EMI 能力强
- 电流特性较同等尺寸传统电感高出 30% 以上
- 省空间，更省电

FEATURES

- Magnetic-resin shielded construction reduces buzz noise to ultra-low levels
- Metallization on ferrite core results in excellent shock resistance and damage-free durability
- Closed magnetic circuit design reduces leakage flux and Electro Magnetic Interference (EMI)
- 30% higher current rating than conventional inductors of equal size
- Takes up less PCB real estate and save more

用途

- 智能手机、智能电视、机顶盒、笔记本电脑
- 车载导航影音、通讯设备
- 虚拟现实、增强现实
- LED 照明

APPLICATIONS

- Smart phone, smart TV, set top box, notebook
- Car navigation systems, telecomm base stations
- VR, AR
- LED lighting

产品型号

SWPA **3012** **S** **1R0**
 ① ② ③ ④

① 分类 Type	
SWPA	绕线贴片功率电感 Wire Wound SMD Power Inductor

③ 特性类型 Feature Type	
S	标准型 Standard

④ 公称电感量 Nominal Inductance	
Example	Nominal Value
1R0	1.0μH
100	10μH

⑤ 感量精度 Inductance Tolerance	
K	±10%
M	±20%
N	±30%

⑥ 包装 Packing	
T	Tape Carrier Package

⑦ 设计代号 Design Code	
□□□	Standard product is blank

PRODUCT IDENTIFICATION

N **T** □□□
 ⑤ ⑥ ⑦

② 外形尺寸尺寸(L×W×H) [mm] External Dimensions (L×W×H) [mm]	
252010	2.5×2.0×1.0
252012	2.5×2.0×1.2
3010	3.0×3.0×1.0
3012	3.0×3.0×1.2
3015	3.0×3.0×1.5
4010	4.0×4.0×1.0
4012	4.0×4.0×1.2
4018	4.0×4.0×1.8
4020	4.0×4.0×2.0
4030	4.0×4.0×3.0
5012	5.0×5.0×1.2
5020	5.0×5.0×2.0
5040	5.0×5.0×4.0
5045	5.0×5.0×4.5
6020	6.0×6.0×2.0
6028	6.0×6.0×2.8
6045	6.0×6.0×4.5
8040	8.0×8.0×4.0
8060	8.0×8.0×6.0
8065	8.0×8.0×6.5

外观尺寸

SHAPE AND DIMENSIONS

Fig.1

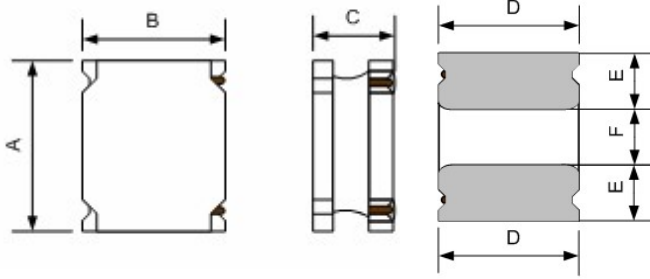

Fig.2

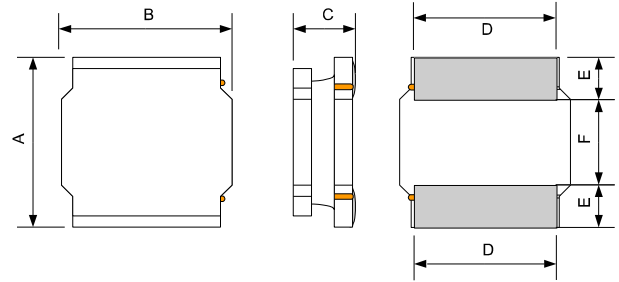
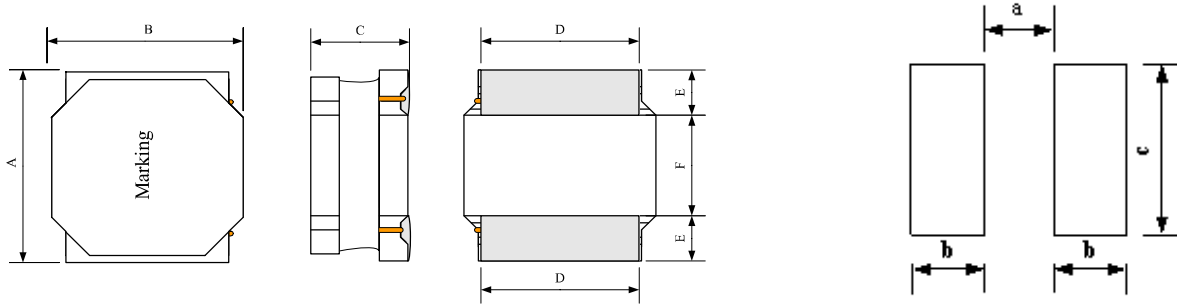

Fig.3



Recommended Land Pattern

Unit: mm

Series	Shape	A	B	C	D	E	F	a Typ.	b Typ.	c Typ.
SWPA252010S	Fig.1	2.5±0.1	2.0±0.1	1.0 Max.	2.0±0.2	0.80±0.2	0.80±0.2	0.80	0.85	2.0
SWPA252012S	Fig.1	2.5±0.1	2.0±0.1	1.2 Max.	2.0±0.2	0.80±0.2	0.80±0.2	0.80	0.85	2.0
SWPA3010S	Fig.2	3.0±0.2	3.0±0.2	1.0 Max.	2.5±0.2	0.75±0.2	1.5±0.2	1.5	0.8	2.7
SWPA3012S	Fig.2	3.0±0.2	3.0±0.2	1.2 Max.	2.5±0.2	0.75±0.2	1.5±0.2	1.5	0.8	2.7
SWPA3015S	Fig.2	3.0±0.2	3.0±0.2	1.5 Max.	2.5±0.2	0.75±0.2	1.5±0.2	1.5	0.8	2.7
SWPA4010S	Fig.2	4.0±0.2	4.0±0.2	1.0 Max.	3.3±0.2	0.95±0.2	2.1±0.2	1.9	1.1	3.7
SWPA4012S	Fig.2	4.0±0.2	4.0±0.2	1.2 Max.	3.3±0.2	0.95±0.2	2.1±0.2	1.9	1.1	3.7
SWPA4018S	Fig.2	4.0±0.2	4.0±0.2	1.8 Max.	3.3±0.2	0.95±0.2	2.1±0.2	1.9	1.1	3.7
SWPA4020S	Fig.2	4.0±0.2	4.0±0.2	2.0 Max.	3.3±0.2	0.95±0.2	2.1±0.2	1.9	1.1	3.7
SWPA4030S	Fig.2	4.0±0.2	4.0±0.2	3.0 Max.	3.3±0.2	0.95±0.2	2.1±0.2	1.9	1.1	3.7
SWPA5012S	Fig.3	5.0±0.2	5.0±0.2	1.2 Max.	4.0±0.2	1.25±0.2	2.5±0.2	2.3	1.4	4.2
SWPA5020S	Fig.3	5.0±0.2	5.0±0.2	2.0 Max.	4.0±0.2	1.25±0.2	2.5±0.2	2.3	1.4	4.2
SWPA5040S	Fig.3	5.0±0.2	5.0±0.2	4.0 Max.	4.0±0.2	1.25±0.2	2.5±0.2	2.3	1.4	4.2
SWPA5045S	Fig.3	5.0±0.2	5.0±0.2	4.5 Max.	4.0±0.2	1.30±0.2	2.5±0.2	2.3	1.4	4.2
SWPA6020S	Fig.2	6.0±0.3	6.0±0.3	2.0 Max.	4.9±0.3	1.55±0.3	2.9±0.3	2.8	1.7	5.7
SWPA6028S	Fig.2	6.0±0.3	6.0±0.3	2.8 Max.	4.9±0.3	1.55±0.3	2.9±0.3	2.8	1.7	5.7
SWPA6045S	Fig.2	6.0±0.3	6.0±0.3	4.5 Max.	4.9±0.3	1.55±0.3	2.9±0.3	2.8	1.7	5.7
SWPA8040S	Fig.2	8.0±0.3	8.0±0.3	4.2 Max.	6.3±0.3	2.00±0.3	4.0±0.3	3.8	2.2	7.5
SWPA8060S	Fig.2	8.0±0.3	8.0±0.3	6.0 Max.	6.3±0.3	2.00±0.3	4.0±0.3	3.8	2.2	7.5
SWPA8065S	Fig.3	8.0±0.3	8.0±0.3	6.5 Max.	6.3±0.3	2.00±0.3	4.0±0.3	3.8	2.2	7.5

※*1: All products are printed with Marking except the 252010S, 252012S, 3010S, 3012S and 3015S series.

规格特性

SPECIFICATIONS

SWPA252010S Series

Part Number 型号	Inductance 电感量	DC Resistance 直流电阻		Self-resonant Frequency 自谐频率	Saturation Current 饱和电流 ^{*3}		Heat Rating Current 温升电流 ^{*4}	
		Max.	Typ.		Max.	Typ.	Max.	Typ.
Units 单位	@100kHz, 1V µH	Ω		Min. MHz	A		A	
Symbol 符号	L	DCR		S.R.F	Isat		Irms	
SWPA252010SR47NT	0.47±30%	0.056	0.047	206	2.50	3.35	2.35	2.56
SWPA252010SR56NT	0.56±30%	0.072	0.060	160	2.90	3.20	2.00	2.18
SWPA252010SR68NT	0.68±30%	0.074	0.062	129	2.20	2.75	2.00	2.18
SWPA252010S1R0NT	1.0±30%	0.108	0.090	100	1.85	2.20	1.65	1.80
SWPA252010S1R5NT	1.5±30%	0.182	0.152	81	1.80	2.10	1.30	1.42
SWPA252010S2R2NT	2.2±30%	0.209	0.174	61	1.20	1.60	1.20	1.31
SWPA252010S3R3MT	3.3±20%	0.328	0.273	47	1.05	1.30	0.90	0.98
SWPA252010S4R7MT	4.7±20%	0.563	0.469	42	0.95	1.15	0.70	0.76
SWPA252010S5R6MT	5.6±20%	0.563	0.469	35	0.80	0.95	0.73	0.80
SWPA252010S6R8MT	6.8±20%	0.896	0.747	31	0.78	0.92	0.59	0.64
SWPA252010S100MT	10±20%	1.092	0.910	27	0.65	0.78	0.50	0.55

SWPA252012S Series

Part Number 型号	Inductance 电感量	DC Resistance 直流电阻		Self-resonant Frequency 自谐频率	Saturation Current 饱和电流 ^{*3}		Heat Rating Current 温升电流 ^{*4}	
		Max.	Typ.		Max.	Typ.	Max.	Typ.
Units 单位	@100kHz, 1V µH	Ω		Min. MHz	A		A	
Symbol 符号	L	DCR		S.R.F	Isat		Irms	
SWPA252012SR47NT	0.47±30%	0.061	0.047	160	3.82	4.27	2.15	2.34
SWPA252012SR68NT	0.68±30%	0.074	0.057	140	3.28	3.68	1.95	2.13
SWPA252012S1R0NT	1.0±30%	0.090	0.069	110	2.59	2.90	1.93	2.10
SWPA252012S1R2NT	1.2±30%	0.129	0.099	100	2.38	2.67	1.46	1.59
SWPA252012S1R5MT	1.5±20%	0.147	0.113	97	2.24	2.51	1.40	1.53
SWPA252012S2R2MT	2.2±20%	0.216	0.166	69	1.85	2.07	1.15	1.25
SWPA252012S2R7MT	2.7±20%	0.239	0.184	63	1.72	1.92	1.09	1.19
SWPA252012S3R3MT	3.3±20%	0.264	0.203	62	1.61	1.80	1.04	1.13
SWPA252012S3R6MT	3.6±20%	0.348	0.268	53	1.46	1.64	0.90	0.98
SWPA252012S4R3MT	4.3±20%	0.377	0.290	51	1.37	1.53	0.87	0.95
SWPA252012S4R7MT	4.7±20%	0.377	0.290	47	1.12	1.25	0.84	0.92
SWPA252012S5R1MT	5.1±20%	0.500	0.385	44	1.23	1.37	0.75	0.82
SWPA252012S5R6MT	5.6±20%	0.538	0.414	38	1.11	1.25	0.73	0.80
SWPA252012S6R2MT	6.2±20%	0.542	0.417	38	1.03	1.16	0.73	0.80
SWPA252012S6R8MT	6.8±20%	0.581	0.447	38	0.98	1.09	0.69	0.75
SWPA252012S7R5MT	7.5±20%	0.611	0.470	35	0.97	1.09	0.68	0.74
SWPA252012S8R2MT	8.2±20%	0.658	0.506	36	0.98	1.10	0.65	0.71
SWPA252012S9R1MT	9.1±20%	0.690	0.531	34	0.91	1.02	0.62	0.68
SWPA252012S100MT	10±20%	0.690	0.531	34	0.79	0.88	0.62	0.68
SWPA252012S120MT	12±20%	1.075	0.827	28	0.78	0.88	0.51	0.56
SWPA252012S150MT	15±20%	1.591	1.224	25	0.68	0.77	0.42	0.46
SWPA252012S220MT	22±20%	1.976	1.520	20	0.53	0.59	0.38	0.41

规格特性

SPECIFICATIONS

SWPA3010S Series

Part Number 型号	Inductance 电感量 @100kHz,1V	DC Resistance 直流电阻		Self-resonant Frequency 自谐频率	Saturation Current 饱和电流 ^{*3}		Heat Rating Current 温升电流 ^{*4}	
		Max.	Typ.		Max.	Typ.	Max.	Typ.
Units 单位	μH	Ω		MHz	A		A	
Symbol 符号	L	DCR		S.R.F	Isat		Irms	
SWPA3010S1R0NT	1.0±30%	0.085	0.065	180	1.40	2.10	1.45	1.80
SWPA3010S1R2NT	1.2±30%	0.085	0.065	137	1.25	1.70	1.45	1.80
SWPA3010S1R5NT	1.5±30%	0.104	0.080	120	1.27	1.70	1.30	1.60
SWPA3010S2R2NT	2.2±30%	0.143	0.110	100	1.15	1.50	1.09	1.40
SWPA3010S2R7MT	2.7±20%	0.169	0.130	90	1.00	1.20	1.02	1.40
SWPA3010S3R3NT	3.3±30%	0.189	0.145	74	0.97	1.20	0.96	1.20
SWPA3010S3R6MT	3.6±20%	0.215	0.165	67	0.95	1.20	0.90	1.10
SWPA3010S4R7MT	4.7±20%	0.293	0.225	59	0.75	1.05	0.77	1.10
SWPA3010S5R6MT	5.6±20%	0.322	0.248	40	0.58	0.65	0.70	1.05
SWPA3010S6R8MT	6.8±20%	0.397	0.305	42	0.55	0.72	0.66	0.96
SWPA3010S8R2MT	8.2±20%	0.520	0.40	23	0.55	0.70	0.58	0.70
SWPA3010S100MT	10±20%	0.520	0.40	39	0.55	0.75	0.58	0.70
SWPA3010S120MT	12±20%	0.657	0.505	36	0.43	0.65	0.52	0.67
SWPA3010S150MT	15±20%	0.793	0.610	30	0.42	0.57	0.47	0.57
SWPA3010S220MT	22±20%	1.209	0.930	28	0.35	0.48	0.38	0.52
SWPA3010S270MT	27±20%	1.404	1.080	25	0.30	0.45	0.35	0.50
SWPA3010S330MT	33±20%	2.015	1.550	18	0.29	0.42	0.30	0.55
SWPA3010S390MT	39±20%	2.275	1.750	18	0.28	0.38	0.28	0.53
SWPA3010S430MT	43±20%	2.340	1.80	18	0.23	0.36	0.27	0.52
SWPA3010S470MT	47±20%	2.535	1.950	18	0.22	0.35	0.26	0.52
SWPA3010S510MT	51±20%	2.860	2.20	18	0.21	0.33	0.25	0.48
SWPA3010S560MT	56±20%	3.016	2.320	16	0.21	0.28	0.24	0.35

SWPA3012S Series

Part Number 型号	Inductance 电感量 @100kHz,1V	DC Resistance 直流电阻		Self-resonant Frequency 自谐频率	Saturation Current 饱和电流 ^{*3}		Heat Rating Current 温升电流 ^{*4}	
		Max.	Typ.		Max.	Typ.	Max.	Typ.
Units 单位	μH	Ω		MHz	A		A	
Symbol 符号	L	DCR		S.R.F	Isat		Irms	
SWPA3012SR22NT	0.22±30%	0.022	0.017	321	5.30	6.00	3.00	3.30
SWPA3012SR82NT	0.82±30%	0.039	0.030	180	2.05	2.80	2.47	3.00
SWPA3012S1R0NT	1.0±30%	0.052	0.040	120	1.87	2.80	2.20	2.70
SWPA3012S1R2NT	1.2±30%	0.059	0.045	120	2.22	2.50	2.01	2.20
SWPA3012S1R5NT	1.5±30%	0.059	0.045	110	1.62	1.90	2.01	2.20
SWPA3012S1R8NT	1.8±30%	0.082	0.063	90	1.30	1.90	1.65	1.80
SWPA3012S2R2NT	2.2±30%	0.098	0.075	84	1.20	1.90	1.55	1.70
SWPA3012S2R4NT	2.4±30%	0.088	0.068	100	1.15	1.50	1.60	1.70
SWPA3012S2R7NT	2.7±30%	0.110	0.085	65	1.14	1.50	1.48	1.50
SWPA3012S3R3MT	3.3±20%	0.130	0.10	64	1.05	1.50	1.36	1.40
SWPA3012S3R6MT	3.6±20%	0.130	0.10	36	1.05	1.50	1.36	1.40
SWPA3012S3R9MT	3.9±20%	0.189	0.145	61	1.00	1.30	1.24	1.30
SWPA3012S4R7MT	4.7±20%	0.156	0.120	61	0.90	1.00	1.24	1.30
SWPA3012S6R8MT	6.8±20%	0.247	0.190	61	0.75	0.90	0.98	1.10
SWPA3012S100MT	10±20%	0.345	0.265	42	0.60	0.88	0.83	0.90
SWPA3012S120MT	12±20%	0.449	0.345	32	0.48	0.67	0.73	0.84
SWPA3012S150MT	15±20%	0.468	0.360	27	0.45	0.62	0.71	0.77
SWPA3012S180MT	18±20%	0.709	0.545	25	0.43	0.59	0.58	0.65
SWPA3012S220MT	22±20%	0.839	0.645	23	0.42	0.52	0.53	0.59

规格特性

SPECIFICATIONS

SWPA3012S Series

Part Number 型号	Inductance 电感量 @100kHz,1V	DC Resistance 直流电阻		Self-resonant Frequency 自谐频率	Saturation Current 饱和电流 ^{*3}		Heat Rating Current 温升电流 ^{*4}	
		Max.	Typ.		Min.	Max.	Typ.	Max.
Units 单位	μH	Ω		MHz	A		A	
Symbol 符号	L	DCR		S.R.F	Isat		Irms	
SWPA3012S270MT	27±20%	1.131	0.870	21	0.35	0.48	0.47	0.51
SWPA3012S330MT	33±20%	1.138	0.875	18	0.36	0.46	0.46	0.50
SWPA3012S360MT	36±20%	1.235	0.950	18	0.34	0.44	0.44	0.48
SWPA3012S390MT	39±20%	1.729	1.330	18	0.30	0.39	0.37	0.41
SWPA3012S470MT	47±20%	1.885	1.450	14	0.27	0.35	0.35	0.40
SWPA3012S560MT	56±20%	1.794	1.380	9	0.26	0.33	0.28	0.40
SWPA3012S680MT	68±20%	2.171	1.670	7	0.24	0.29	0.33	0.37
SWPA3012S820MT	82±20%	3.302	2.540	7	0.17	0.27	0.27	0.31
SWPA3012S101MT	100±20%	3.718	2.860	5	0.21	0.23	0.25	0.29

SWPA3015S Series

Part Number 型号	Inductance 电感量 @100kHz,1V	DC Resistance 直流电阻		Self-resonant Frequency 自谐频率	Saturation Current 饱和电流 ^{*3}		Heat Rating Current 温升电流 ^{*4}	
		Max.	Typ.		Min.	Max.	Typ.	Max.
Units 单位	μH	Ω		MHz	A		A	
Symbol 符号	L	DCR		S.R.F	Isat		Irms	
SWPA3015SR50NT	0.5±30%	0.039	0.030	162	3.90	4.20	2.60	2.80
SWPA3015S1R0NT	1.0±30%	0.039	0.030	150	2.32	2.80	2.35	2.50
SWPA3015S1R2NT	1.2±30%	0.052	0.040	110	2.21	3.10	1.95	2.30
SWPA3015S1R5NT	1.5±30%	0.065	0.050	100	2.30	2.70	1.70	2.20
SWPA3015S1R8NT	1.8±30%	0.065	0.050	92	1.75	2.20	1.70	2.20
SWPA3015S2R2NT	2.2±30%	0.078	0.060	86	1.60	2.00	1.60	2.00
SWPA3015S2R7NT	2.7±30%	0.098	0.075	64	1.52	1.90	1.43	1.90
SWPA3015S3R3MT	3.3±20%	0.104	0.080	68	1.32	1.81	1.36	1.60
SWPA3015S3R6MT	3.6±20%	0.137	0.105	59	1.28	1.60	1.20	1.50
SWPA3015S3R9MT	3.9±20%	0.137	0.105	47	1.20	1.40	1.20	1.50
SWPA3015S4R3MT	4.3±20%	0.150	0.115	53	1.20	1.40	1.14	1.30
SWPA3015S4R7MT	4.7±20%	0.163	0.125	46	1.10	1.40	1.09	1.30
SWPA3015S5R1MT	5.1±20%	0.173	0.133	49	1.00	1.20	1.05	1.20
SWPA3015S6R2MT	6.2±20%	0.254	0.195	46	1.00	1.20	0.86	1.00
SWPA3015S6R8MT	6.8±20%	0.260	0.20	39	0.85	1.10	0.85	1.10
SWPA3015S100MT	10±20%	0.325	0.250	41	0.72	0.92	0.77	0.90
SWPA3015S120MT	12±20%	0.416	0.320	32	0.70	0.90	0.68	0.89
SWPA3015S150MT	15±20%	0.455	0.350	30	0.66	0.88	0.65	0.72
SWPA3015S180MT	18±20%	0.559	0.430	23	0.56	0.72	0.59	0.72
SWPA3015S220MT	22±20%	0.598	0.460	23	0.52	0.68	0.57	0.69
SWPA3015S270MT	27±20%	0.949	0.730	22	0.48	0.56	0.45	0.56
SWPA3015S330MT	33±20%	1.066	0.820	20	0.44	0.53	0.43	0.51
SWPA3015S390MT	39±20%	1.294	0.995	14	0.41	0.55	0.39	0.44
SWPA3015S430MT	43±20%	1.378	1.060	16	0.37	0.43	0.37	0.48
SWPA3015S470MT	47±20%	1.625	1.250	14	0.35	0.43	0.35	0.44
SWPA3015S560MT	56±20%	1.664	1.280	13	0.33	0.42	0.34	0.41
SWPA3015S620MT	62±20%	2.093	1.610	13	0.30	0.40	0.30	0.41
SWPA3015S680MT	68±20%	3.510	2.700	11	0.28	0.37	0.23	0.31
SWPA3015S101MT	100±20%	4.043	3.110	7.2	0.23	0.25	0.21	0.25
SWPA3015S151MT	150±20%	4.940	3.80	4.5	0.18	0.22	0.19	0.23

规格特性

SPECIFICATIONS

SWPA4010S Series

Part Number 型号	Inductance 电感量 @100kHz,1V	DC Resistance 直流电阻		Self-resonant Frequency 自谐频率 Min.	Saturation Current 饱和电流 ^{*3}		Heat Rating Current 温升电流 ^{*4}	
		Max.	Typ.		Max.	Typ.	Max.	Typ.
Units 单位	μH	Ω		MHz	A		A	
Symbol 符号	L	DCR		S.R.F	Isat		Irms	
SWPA4010S1R0NT	1.0±30%	0.067	0.056	104	2.00	2.30	1.90	2.40
SWPA4010S1R5NT	1.5±30%	0.084	0.070	71	1.68	2.00	1.70	2.00
SWPA4010S2R2MT	2.2±20%	0.102	0.085	52	1.20	1.50	1.50	2.00
SWPA4010S3R3MT	3.3±20%	0.120	0.100	42	1.10	1.40	1.40	1.80
SWPA4010S4R7MT	4.7±20%	0.168	0.140	30	0.95	1.10	1.20	1.50
SWPA4010S6R8MT	6.8±20%	0.240	0.200	26	0.80	0.95	1.00	1.20
SWPA4010S100MT	10±20%	0.360	0.300	19	0.62	0.75	0.75	1.00
SWPA4010S150MT	15±20%	0.516	0.430	17	0.54	0.61	0.60	0.85
SWPA4010S220MT	22±20%	0.684	0.570	11	0.45	0.52	0.50	0.75

SWPA4012S Series

Part Number 型号	Inductance 电感量 @100kHz,1V	DC Resistance 直流电阻		Self-resonant Frequency 自谐频率 Min.	Saturation Current 饱和电流 ^{*3}		Heat Rating Current 温升电流 ^{*4}	
		Max.	Typ.		Max.	Typ.	Max.	Typ.
Units 单位	μH	Ω		MHz	A		A	
Symbol 符号	L	DCR		S.R.F	Isat		Irms	
SWPA4012SR82NT	0.82±30%	0.065	0.050	150	3.02	3.30	1.65	2.50
SWPA4012S1R0NT	1.0±30%	0.065	0.050	120	2.61	3.20	1.65	2.50
SWPA4012S1R5NT	1.5±30%	0.085	0.065	90	2.10	2.70	1.46	2.20
SWPA4012S1R8NT	1.8±30%	0.104	0.080	88	2.12	2.60	1.32	1.90
SWPA4012S2R2NT	2.2±30%	0.104	0.080	74	1.76	2.30	1.32	1.90
SWPA4012S2R7NT	2.7±30%	0.117	0.090	71	1.90	2.30	1.25	1.70
SWPA4012S3R3NT	3.3±30%	0.143	0.110	60	1.72	2.10	1.12	1.60
SWPA4012S3R6NT	3.6±30%	0.143	0.110	57	1.20	1.70	1.12	1.60
SWPA4012S4R3NT	4.3±30%	0.182	0.140	54	1.58	1.70	1.00	1.50
SWPA4012S4R7NT	4.7±30%	0.163	0.125	50	1.15	1.80	1.05	1.50
SWPA4012S5R1NT	5.1±30%	0.201	0.155	50	1.55	1.60	0.95	1.50
SWPA4012S5R6NT	5.6±30%	0.182	0.140	42	1.00	1.60	1.00	1.20
SWPA4012S6R8MT	6.8±20%	0.257	0.198	40	0.85	1.40	0.84	1.20
SWPA4012S100MT	10±20%	0.345	0.265	33	0.80	1.10	0.77	1.00
SWPA4012S120MT	12±20%	0.377	0.290	32	0.66	1.00	0.70	0.95
SWPA4012S150MT	15±20%	0.442	0.340	25	0.56	0.80	0.64	0.85
SWPA4012S180MT	18±20%	0.611	0.470	23	0.55	0.75	0.55	0.80
SWPA4012S220MT	22±20%	0.763	0.587	20	0.46	0.70	0.49	0.75
SWPA4012S270MT	27±20%	0.936	0.720	18	0.50	0.70	0.45	0.60
SWPA4012S330MT	33±20%	1.053	0.810	17	0.42	0.60	0.42	0.58
SWPA4012S360MT	36±20%	1.170	0.90	14	0.40	0.50	0.40	0.56
SWPA4012S390MT	39±20%	1.430	1.10	16	0.55	0.66	0.37	0.50
SWPA4012S470MT	47±20%	1.430	1.10	12	0.35	0.50	0.37	0.50
SWPA4012S560MT	56±20%	1.625	1.250	11	0.33	0.45	0.33	0.46
SWPA4012S680MT	68±20%	2.535	1.950	11	0.38	0.45	0.27	0.45
SWPA4012S820MT	82±20%	2.782	2.140	11	0.28	0.40	0.26	0.36
SWPA4012S101MT	100±20%	2.873	2.210	9.4	0.25	0.30	0.25	0.35

规格特性

SPECIFICATIONS

SWPA4018S Series

Part Number 型号	Inductance 电感量 @100kHz,1V	DC Resistance 直流电阻		Self-resonant Frequency 自谐频率	Saturation Current 饱和电流 ^{*3}		Heat Rating Current 温升电流 ^{*4}	
		Max.	Typ.		Min.	Max.	Typ.	Max.
Units 单位	μH	Ω		MHz	A		A	
Symbol 符号	L	DCR		S.R.F	Isat		Irms	
SWPA4018SR47NT	0.47±30%	0.018	0.014	155	4.30	5.20	4.00	4.50
SWPA4018SR68NT	0.68±30%	0.026	0.020	128	4.90	5.60	3.30	3.80
SWPA4018S1R0NT	1.0±30%	0.033	0.025	80	4.80	5.20	2.00	3.30
SWPA4018S1R5NT	1.5±30%	0.039	0.030	65	3.35	4.00	1.80	3.20
SWPA4018S1R8NT	1.8±30%	0.044	0.034	54	3.00	3.40	2.00	2.80
SWPA4018S2R2MT	2.2±20%	0.059	0.045	52	2.70	3.20	1.65	2.60
SWPA4018S3R3MT	3.3±20%	0.091	0.070	44	2.45	2.90	1.23	2.10
SWPA4018S4R7MT	4.7±20%	0.117	0.090	34	1.70	2.20	1.20	1.80
SWPA4018S6R8MT	6.8±20%	0.143	0.110	29	1.45	2.00	1.06	1.50
SWPA4018S100MT	10±20%	0.234	0.180	24	1.30	1.60	0.84	1.20
SWPA4018S150MT	15±20%	0.325	0.250	19	0.94	1.10	0.65	1.00
SWPA4018S220MT	22±20%	0.468	0.360	16	0.80	0.88	0.59	0.85
SWPA4018S330MT	33±20%	0.689	0.530	12	0.56	0.75	0.49	0.72
SWPA4018S470MT	47±20%	0.845	0.650	10	0.57	0.70	0.42	0.65
SWPA4018S680MT	68±20%	1.30	1.0	8.3	0.47	0.51	0.32	0.52
SWPA4018S101MT	100±20%	2.275	1.750	6.5	0.40	0.44	0.25	0.41
SWPA4018S151MT	150±20%	3.250	2.50	5.5	0.31	0.34	0.22	0.36
SWPA4018S221MT	220±20%	5.20	4.0	4	0.27	0.30	0.17	0.27

SWPA4020S Series

Part Number 型号	Inductance 电感量 @100kHz,1V	DC Resistance 直流电阻		Self-resonant Frequency 自谐频率	Saturation Current 饱和电流 ^{*3}		Heat Rating Current 温升电流 ^{*4}	
		Max.	Typ.		Min.	Max.	Typ.	Max.
Units 单位	μH	Ω		MHz	A		A	
Symbol 符号	L	DCR		S.R.F	Isat		Irms	
SWPA4020SR24MT	0.24±20%	0.014	0.011	283	10.5	12.5	4.50	5.20
SWPA4020SR33NT	0.33±30%	0.016	0.013	223	7.50	8.50	3.30	4.90
SWPA4020SR47NT	0.47±30%	0.029	0.022	160	7.00	7.50	3.30	3.70
SWPA4020SR68NT	0.68±30%	0.036	0.028	120	6.40	6.60	2.80	3.30
SWPA4020S1R0NT	1.0±30%	0.038	0.029	75	4.78	5.20	2.15	3.20
SWPA4020S1R2NT	1.2±30%	0.038	0.029	72	5.10	5.60	2.15	3.20
SWPA4020S1R5NT	1.5±30%	0.046	0.035	71	4.45	4.90	1.98	3.00
SWPA4020S2R2MT	2.2±20%	0.052	0.040	49	3.40	3.70	1.85	2.80
SWPA4020S3R3MT	3.3±20%	0.091	0.070	44	3.20	3.50	1.40	2.50
SWPA4020S3R6MT	3.6±20%	0.072	0.055	49	2.80	3.00	1.54	2.50
SWPA4020S4R7MT	4.7±20%	0.098	0.075	42	2.35	2.50	1.34	2.00
SWPA4020S5R1MT	5.1±20%	0.111	0.085	42	2.30	2.50	1.27	1.80
SWPA4020S5R6MT	5.6±20%	0.117	0.090	30	2.20	2.40	1.22	1.80
SWPA4020S6R2MT	6.2±20%	0.150	0.115	36	2.15	2.30	1.08	1.60
SWPA4020S6R8MT	6.8±20%	0.163	0.125	33	2.20	2.40	1.04	1.60
SWPA4020S7R5MT	7.5±20%	0.150	0.115	30	1.85	2.00	1.08	1.50
SWPA4020S8R2MT	8.2±20%	0.163	0.125	27	1.75	1.90	1.04	1.40
SWPA4020S100MT	10±20%	0.215	0.165	26	1.60	1.70	0.90	1.20
SWPA4020S120MT	12±20%	0.228	0.175	26	1.50	1.60	0.88	1.20
SWPA4020S150MT	15±20%	0.299	0.230	24	1.35	1.50	0.77	1.10
SWPA4020S220MT	22±20%	0.455	0.350	15	1.05	1.10	0.62	0.87
SWPA4020S270MT	27±20%	0.709	0.545	14	1.02	1.10	0.50	0.70

规格特性

SPECIFICATIONS

SWPA4020S Series

Part Number 型号	Inductance 电感量 @100kHz,1V	DC Resistance 直流电阻		Self-resonant Frequency 自谐频率	Saturation Current 饱和电流 ^{*3}		Heat Rating Current 温升电流 ^{*4}	
		Max.	Typ.		Min.	Max.	Typ.	Max.
Units 单位	μH	Ω		MHz	A		A	
Symbol 符号	L	DCR		S.R.F	Isat		Irms	
SWPA4020S330MT	33±20%	0.715	0.550	11	0.85	0.93	0.49	0.68
SWPA4020S390MT	39±20%	0.845	0.650	11	0.82	0.90	0.46	0.64
SWPA4020S430MT	43±20%	0.858	0.660	10	0.77	0.85	0.45	0.63
SWPA4020S470MT	47±20%	0.923	0.710	10	0.74	0.81	0.44	0.61
SWPA4020S510MT	51±20%	0.975	0.750	10	0.70	0.77	0.42	0.59
SWPA4020S560MT	56±20%	1.040	0.80	10	0.66	0.72	0.41	0.57
SWPA4020S620MT	62±20%	1.170	0.90	9.6	0.65	0.71	0.39	0.52
SWPA4020S680MT	68±20%	1.380	1.060	7.7	0.61	0.67	0.36	0.50
SWPA4020S750MT	75±20%	1.510	1.160	7.7	0.70	0.77	0.35	0.49
SWPA4020S820MT	82±20%	1.520	1.170	7.2	0.50	0.55	0.34	0.47
SWPA4020S101MT	100±20%	2.020	1.550	6.3	0.48	0.53	0.31	0.43

SWPA4030S Series

Part Number 型号	Inductance 电感量 @100kHz,1V	DC Resistance 直流电阻		Self-resonant Frequency 自谐频率	Saturation Current 饱和电流 ^{*3}		Heat Rating Current 温升电流 ^{*4}	
		Max.	Typ.		Min.	Max.	Typ.	Max.
Units 单位	μH	Ω		MHz	A		A	
Symbol 符号	L	DCR		S.R.F	Isat		Irms	
SWPA4030SR47NT	0.47±30%	0.0104	0.008	184	7.80	9.80	5.20	5.90
SWPA4030SR68NT	0.68±30%	0.013	0.010	130	6.80	8.00	4.56	5.10
SWPA4030SR91NT	0.91±30%	0.017	0.013	100	6.25	6.80	4.15	4.70
SWPA4030S1R0NT	1.0±30%	0.018	0.014	70	5.26	5.70	4.15	4.70
SWPA4030S1R2NT	1.2±30%	0.020	0.015	80	5.80	6.30	3.82	4.20
SWPA4030S1R5NT	1.5±30%	0.026	0.020	62	4.84	5.30	3.34	3.60
SWPA4030S1R8NT	1.8±30%	0.033	0.025	60	4.50	5.00	3.20	3.30
SWPA4030S2R2NT	2.2±30%	0.039	0.030	52	4.90	5.80	2.95	3.20
SWPA4030S3R3MT	3.3±20%	0.052	0.040	38	3.30	3.60	2.40	2.60
SWPA4030S3R6MT	3.6±20%	0.052	0.040	37	3.00	3.50	2.40	2.60
SWPA4030S3R9MT	3.9±20%	0.074	0.057	32	3.00	3.30	2.10	2.30
SWPA4030S4R3MT	4.3±20%	0.072	0.055	37	2.95	3.20	2.10	2.30
SWPA4030S4R7MT	4.7±20%	0.078	0.060	31	2.90	3.20	2.00	2.30
SWPA4030S5R6MT	5.6±20%	0.085	0.065	30	2.60	2.80	1.95	2.10
SWPA4030S6R8MT	6.8±20%	0.117	0.090	24	2.75	3.00	1.60	1.70
SWPA4030S7R5MT	7.5±20%	0.110	0.085	26	2.20	2.40	1.65	1.80
SWPA4030S8R2MT	8.2±20%	0.117	0.090	26	2.10	2.30	1.60	1.70
SWPA4030S100MT	10±20%	0.130	0.10	21	1.95	2.40	1.50	1.60
SWPA4030S120MT	12±20%	0.175	0.135	18	1.70	1.80	1.30	1.40
SWPA4030S150MT	15±20%	0.247	0.190	16	1.65	1.80	1.11	1.20
SWPA4030S180MT	18±20%	0.260	0.20	10	1.40	1.50	1.10	1.20
SWPA4030S220MT	22±20%	0.293	0.225	10	1.30	1.40	1.00	1.20
SWPA4030S330MT	33±20%	0.429	0.330	10	1.10	1.20	0.84	0.92
SWPA4030S360MT	36±20%	0.436	0.335	9.8	1.05	1.10	0.83	0.91
SWPA4030S390MT	39±20%	0.566	0.435	10	1.03	1.10	0.73	0.80
SWPA4030S470MT	47±20%	0.579	0.445	8.4	0.95	1.00	0.72	0.80
SWPA4030S510MT	51±20%	0.611	0.470	8.4	0.90	1.13	0.70	0.80
SWPA4030S560MT	56±20%	0.722	0.555	8.4	0.85	0.94	0.65	0.71
SWPA4030S620MT	62±20%	0.760	0.585	7	0.80	0.99	0.63	0.70
SWPA4030S680MT	68±20%	1.128	0.868	7	0.72	0.80	0.52	0.57

规格特性

SPECIFICATIONS

SWPA4030S Series

Part Number 型号	Inductance 电感量	DC Resistance 直流电阻		Self-resonant Frequency 自谐频率	Saturation Current 饱和电流 ^{*3}		Heat Rating Current 温升电流 ^{*4}	
		Max.	Typ.		Max.	Typ.	Max.	Typ.
Units 单位	@100kHz,1V μH	Ω		MHz	A		A	
Symbol 符号	L	DCR		S.R.F	Isat		Irms	
SWPA4030S750MT	75±20%	1.326	1.020	6.3	0.70	0.88	0.48	0.53
SWPA4030S820MT	82±20%	1.378	1.060	5.6	0.66	0.72	0.47	0.52
SWPA4030S910MT	91±20%	1.430	1.10	5.6	0.65	0.71	0.46	0.50
SWPA4030S101MT	100±20%	1.495	1.150	5.6	0.60	0.73	0.45	0.49
SWPA4030S121MT	120±20%	1.755	1.350	5.4	0.55	0.60	0.42	0.46
SWPA4030S151MT	150±20%	2.340	1.80	4	0.50	0.55	0.30	0.35
SWPA4030S471KT	470±10%	9.360	7.20	2	0.30	0.35	0.20	0.23
SWPA4030S501MT	500±20%	9.027	6.944	2	0.28	0.30	0.15	0.20
SWPA4030S681MT	680±20%	9.854	7.580	1.2	0.19	0.20	0.14	0.18

SWPA5012S Series

Part Number 型号	Inductance 电感量	DC Resistance 直流电阻		Self-resonant Frequency 自谐频率	Saturation Current 饱和电流 ^{*3}		Heat Rating Current 温升电流 ^{*4}	
		Max.	Typ.		Max.	Typ.	Max.	Typ.
Units 单位	@100kHz,1V μH	Ω		MHz	A		A	
Symbol 符号	L	DCR		S.R.F	Isat		Irms	
SWPA5012S1R0NT	1.0±30%	0.068	0.057	103	4.40	4.70	2.00	2.40
SWPA5012S1R5NT	1.5±30%	0.086	0.072	68	3.70	3.80	1.90	2.20
SWPA5012S2R2NT	2.2±30%	0.108	0.090	50	3.10	3.20	1.70	2.00
SWPA5012S3R3NT	3.3±30%	0.151	0.126	34	2.40	2.60	1.40	1.70
SWPA5012S4R7NT	4.7±30%	0.197	0.164	31	2.20	2.30	1.30	1.50
SWPA5012S6R8MT	6.8±20%	0.294	0.245	22	1.70	1.90	1.00	1.20
SWPA5012S100MT	10±20%	0.413	0.344	17	1.40	1.50	0.85	1.00
SWPA5012S150MT	15±20%	0.523	0.436	13	1.20	1.30	0.80	0.92
SWPA5012S220MT	22±20%	0.858	0.780	16	0.88	0.98	0.60	0.68

SWPA5020S Series

Part Number 型号	Inductance 电感量	DC Resistance 直流电阻		Self-resonant Frequency 自谐频率	Saturation Current 饱和电流 ^{*3}		Heat Rating Current 温升电流 ^{*4}	
		Max.	Typ.		Max.	Typ.	Max.	Typ.
Units 单位	@100kHz,1V μH	Ω		MHz	A		A	
Symbol 符号	L	DCR		S.R.F	Isat		Irms	
SWPA5020SR22NT	0.22±30%	0.011	0.009	280	9.00	12.00	5.30	6.00
SWPA5020SR24NT	0.24±30%	0.011	0.009	248	8.00	10.00	5.30	6.00
SWPA5020SR47NT	0.47±30%	0.017	0.013	160	6.15	6.70	4.60	5.00
SWPA5020SR56NT	0.56±30%	0.022	0.017	137	8.50	9.60	3.80	4.20
SWPA5020SR68NT	0.68±30%	0.022	0.017	120	5.50	6.00	4.00	4.40
SWPA5020SR75NT	0.75±30%	0.022	0.017	117	5.50	6.00	4.00	4.40
SWPA5020S1R0NT	1.0±30%	0.026	0.020	114	4.10	5.00	3.80	4.10
SWPA5020S1R2NT	1.2±30%	0.029	0.022	83	4.50	4.90	3.55	3.90
SWPA5020S1R5NT	1.5±30%	0.034	0.026	68	4.10	4.50	3.20	3.50
SWPA5020S2R2NT	2.2±30%	0.042	0.032	57	3.20	4.00	2.90	3.10
SWPA5020S2R7NT	2.7±30%	0.049	0.038	52	2.90	3.50	2.70	2.90
SWPA5020S3R0NT	3.0±30%	0.049	0.038	49	2.55	2.80	2.70	2.90
SWPA5020S3R3NT	3.3±30%	0.056	0.043	46	2.55	3.00	2.50	2.70
SWPA5020S3R6NT	3.6±30%	0.056	0.043	43	2.80	3.00	2.50	2.70

规格特性

SPECIFICATIONS

SWPA5020S Series

Part Number 型号	Inductance 电感量 @100kHz,1V	DC Resistance 直流电阻		Self-resonant Frequency 自谐频率	Saturation Current 饱和电流 ^{*3}		Heat Rating Current 温升电流 ^{*4}	
		Max.	Typ.		Min.	Max.	Typ.	Max.
Units 单位	μH	Ω		MHz	A		A	
Symbol 符号	L	DCR		S.R.F	Isat		Irms	
SWPA5020S3R9NT	3.9±30%	0.056	0.043	40	2.30	2.80	2.50	2.70
SWPA5020S4R3MT	4.3±20%	0.074	0.057	37	2.50	3.00	2.20	2.40
SWPA5020S4R7MT	4.7±20%	0.074	0.057	37	2.50	2.70	2.20	2.40
SWPA5020S5R1MT	5.1±20%	0.083	0.064	32	2.25	2.60	2.05	2.20
SWPA5020S5R6MT	5.6±20%	0.083	0.064	32	2.30	2.50	2.05	2.20
SWPA5020S6R8MT	6.8±20%	0.108	0.083	30	2.05	2.20	1.80	1.90
SWPA5020S7R5MT	7.5±20%	0.117	0.090	26	1.85	2.00	1.75	1.90
SWPA5020S8R2MT	8.2±20%	0.127	0.098	26	1.85	2.00	1.65	1.80
SWPA5020S9R1MT	9.1±20%	0.143	0.110	24	1.70	1.80	1.55	1.70
SWPA5020S100MT	10±20%	0.143	0.110	24	1.70	1.80	1.55	1.70
SWPA5020S120MT	12±20%	0.182	0.140	22	1.50	1.60	1.40	1.50
SWPA5020S150MT	15±20%	0.215	0.165	20	1.35	1.40	1.25	1.30
SWPA5020S180MT	18±20%	0.260	0.200	16	1.25	1.30	1.15	1.20
SWPA5020S220MT	22±20%	0.294	0.226	14	1.15	1.20	1.10	1.20
SWPA5020S330MT	33±20%	0.507	0.390	10	0.92	1.00	0.90	0.99
SWPA5020S470MT	47±20%	0.680	0.523	7	0.77	0.84	0.77	0.84
SWPA5020S560MT	56±20%	0.819	0.630	6	0.77	0.84	0.70	0.77
SWPA5020S680MT	68±20%	0.962	0.740	6	0.65	0.70	0.64	0.70
SWPA5020S820MT	82±20%	1.158	0.965	6	0.65	0.75	0.50	0.60
SWPA5020S101MT	100±20%	1.430	1.100	6	0.53	0.58	0.53	0.58
SWPA5020S121MT	120±20%	1.755	1.350	6	0.42	0.53	0.40	0.50
SWPA5020S201MT	200±20%	2.60	2.00	4.5	0.30	0.33	0.40	0.45

SWPA5040S Series

Part Number 型号	Inductance 电感量 @100kHz,1V	DC Resistance 直流电阻		Self-resonant Frequency 自谐频率	Saturation Current 饱和电流 ^{*3}		Heat Rating Current 温升电流 ^{*4}	
		Max.	Typ.		Min.	Max.	Typ.	Max.
Units 单位	μH	Ω		MHz	A		A	
Symbol 符号	L	DCR		S.R.F	Isat		Irms	
SWPA5040SR22MT	0.22 ±20%	0.008	0.006	289	18.00	20.00	6.50	7.50
SWPA5040SR24NT	0.24 ±30%	0.008	0.006	251	15.70	18.00	6.40	7.40
SWPA5040SR47MT	0.47 ±20%	0.009	0.007	171	10.00	11.50	6.60	7.60
SWPA5040S1R0NT	1.0±30%	0.016	0.012	117	7.35	8.20	4.90	5.10
SWPA5040S1R2NT	1.2±30%	0.021	0.016	110	6.50	7.00	4.15	4.30
SWPA5040S1R5NT	1.5±30%	0.020	0.015	86	6.30	7.30	4.30	4.80
SWPA5040S1R8MT	1.8±20%	0.021	0.016	55	5.50	6.40	4.15	4.30
SWPA5040S2R2NT	2.2±30%	0.025	0.019	50	4.90	5.50	3.80	4.30
SWPA5040S2R7NT	2.7±30%	0.029	0.022	37	4.30	5.10	3.60	4.10
SWPA5040S3R0NT	3.0±30%	0.029	0.022	37	4.15	4.80	3.60	4.20
SWPA5040S3R3NT	3.3±30%	0.031	0.024	32	3.95	4.60	3.40	3.90
SWPA5040S3R6MT	3.6±20%	0.031	0.026	30	3.80	4.40	3.30	3.70
SWPA5040S3R9NT	3.9±30%	0.035	0.027	29	3.55	4.20	3.20	3.70
SWPA5040S3R9NT	3.9±30%	0.035	0.027	29	3.55	4.20	3.20	3.70
SWPA5040S4R7NT	4.7±30%	0.039	0.030	28	3.50	3.90	3.00	3.30
SWPA5040S5R6MT	5.6±20%	0.046	0.035	27	3.00	3.70	2.80	3.10
SWPA5040S6R8MT	6.8±20%	0.056	0.043	21	2.90	3.50	2.50	2.80
SWPA5040S8R2MT	8.2±20%	0.062	0.048	20	2.70	3.00	2.30	2.60
SWPA5040S100MT	10±20%	0.083	0.064	18	2.35	2.90	2.10	2.40

规格特性

SPECIFICATIONS

SWPA5040S Series

Part Number 型号	Inductance 电感量 @100kHz,1V	DC Resistance 直流电阻		Self-resonant Frequency 自谐频率	Saturation Current 饱和电流 ^{*3}		Heat Rating Current 温升电流 ^{*4}	
		Max.	Typ.		Min.	Max.	Typ.	Max.
Units 单位	μH	Ω		MHz	A		A	
Symbol 符号	L	DCR		S.R.F	Isat		Irms	
SWPA5040S120MT	12±20%	0.100	0.077	14	2.20	2.50	2.00	2.10
SWPA5040S150MT	15±20%	0.112	0.086	13	2.00	2.30	2.00	2.10
SWPA5040S180MT	18±20%	0.155	0.119	12	1.70	2.00	1.45	1.65
SWPA5040S220MT	22±20%	0.168	0.129	11	1.60	1.90	1.50	1.60
SWPA5040S270MT	27±20%	0.244	0.188	9.8	1.52	1.75	1.10	1.25
SWPA5040S330MT	33±20%	0.244	0.188	9	1.30	1.50	1.20	1.40
SWPA5040S470MT	47±20%	0.354	0.272	7	1.10	1.30	1.00	1.10
SWPA5040S510MT	51±20%	0.494	0.380	6	1.00	1.20	1.00	1.10
SWPA5040S560MT	56±20%	0.494	0.380	6	1.05	1.20	0.80	0.90
SWPA5040S680MT	68±20%	0.520	0.40	6	0.90	1.10	0.80	0.90
SWPA5040S750MT	75±20%	0.585	0.450	6	0.85	0.95	0.72	0.80
SWPA5040S101MT	100±20%	0.728	0.560	5	0.75	0.85	0.70	0.80
SWPA5040S151MT	150±20%	0.975	0.750	3.7	0.65	0.67	0.60	0.70
SWPA5040S221MT	220±20%	1.820	1.400	3.0	0.48	0.55	0.40	0.50
SWPA5040S301MT	300±20%	2.600	2.000	2.7	0.50	0.58	0.35	0.40
SWPA5040S331MT	330±20%	2.730	2.100	2.7	0.42	0.47	0.40	0.50
SWPA5040S471MT	470±20%	3.900	3.000	2.7	0.37	0.43	0.35	0.40
SWPA5040S561MT	560±20%	4.914	3.780	1.52	0.31	0.36	0.31	0.35
SWPA5040S681MT	680±20%	5.070	3.900	1.60	0.30	0.35	0.25	0.30

SWPA5045S Series

Part Number 型号	Inductance 电感量 @100kHz,1V	DC Resistance 直流电阻		Self-resonant Frequency 自谐频率	Saturation Current 饱和电流 ^{*3}		Heat Rating Current 温升电流 ^{*4}	
		Max.	Typ.		Min.	Typ.	Typ.	Typ.
Units 单位	μH	Ω		MHz	A		A	
Symbol 符号	L	DCR		S.R.F	Isat		Irms	
SWPA5045S1R5NT	1.5±30%	0.022	0.017	78	7.40	8.50	5.20	5.90
SWPA5045S2R2NT	2.2±20%	0.029	0.022	50	6.40	7.20	4.70	5.40
SWPA5045S3R3MT	3.3±20%	0.035	0.027	36	6.40	7.20	4.20	4.85
SWPA5045S100MT	10±20%	0.079	0.061	17	3.20	3.70	2.50	2.90
SWPA5045S220MT	22±20%	0.163	0.125	10	2.00	2.35	1.55	1.80

SWPA6020S Series

Part Number 型号	Inductance 电感量 @100kHz,1V	DC Resistance 直流电阻		Self-resonant Frequency 自谐频率	Saturation Current 饱和电流 ^{*3}		Heat Rating Current 温升电流 ^{*4}	
		Max.	Typ.		Min.	Max.	Typ.	Max.
Units 单位	μH	Ω		MHz	A		A	
Symbol 符号	L	DCR		S.R.F	Isat		Irms	
SWPA6020SR50NT	0.50±30%	0.018	0.014	120	4.50	6.00	4.00	5.00
SWPA6020SR68NT	0.68±30%	0.022	0.017	115	6.55	7.80	3.80	4.80
SWPA6020SR82NT	0.82±30%	0.022	0.017	110	5.30	6.30	3.80	4.80
SWPA6020S1R0NT	1.0±30%	0.026	0.020	100	4.15	5.00	3.50	4.40
SWPA6020S1R2NT	1.2±30%	0.029	0.022	88	5.90	7.00	3.20	4.00
SWPA6020S1R5NT	1.5±30%	0.029	0.022	79	4.25	5.10	3.20	4.00
SWPA6020S1R8NT	1.8±30%	0.036	0.028	68	4.85	5.80	2.75	3.50
SWPA6020S2R0NT	2.0±30%	0.046	0.035	65	4.10	4.90	2.60	3.30

规格特性

SPECIFICATIONS

SWPA6020S Series

Part Number 型号	Inductance 电感量 @100kHz,1V	DC Resistance 直流电阻		Self-resonant Frequency 自谐频率	Saturation Current 饱和电流 ^{*3}		Heat Rating Current 温升电流 ^{*4}	
		Max.	Typ.		Max.	Typ.	Max.	Typ.
Units 单位	μH	Ω		MHz	A		A	
Symbol 符号	L	DCR		S.R.F	Isat		Irms	
SWPA6020S2R2NT	2.2±30%	0.036	0.028	61	3.75	4.50	2.75	3.50
SWPA6020S2R7NT	2.7±30%	0.046	0.035	56	3.90	4.60	2.60	3.30
SWPA6020S3R3NT	3.3±30%	0.046	0.035	51	3.15	3.70	2.60	3.30
SWPA6020S3R9NT	3.9±30%	0.064	0.049	45	3.25	3.90	2.10	2.60
SWPA6020S4R3NT	4.3±30%	0.064	0.049	44	2.70	3.20	2.10	2.60
SWPA6020S4R7NT	4.7±30%	0.075	0.058	41	3.00	3.60	2.00	2.50
SWPA6020S5R6NT	5.6±30%	0.075	0.058	36	2.40	2.90	1.90	2.40
SWPA6020S6R2NT	6.2±30%	0.103	0.079	31	2.30	2.70	1.80	2.30
SWPA6020S6R8NT	6.8±30%	0.103	0.079	31	2.20	2.60	1.80	2.30
SWPA6020S8R2NT	8.2±30%	0.137	0.105	27	2.10	2.50	1.40	1.80
SWPA6020S100MT	10±20%	0.137	0.105	27	1.75	2.10	1.40	1.80
SWPA6020S120MT	12±20%	0.156	0.120	25	1.45	1.70	1.30	1.60
SWPA6020S150MT	15±20%	0.189	0.145	21	1.20	1.40	1.20	1.50
SWPA6020S180MT	18±20%	0.234	0.180	18	1.20	1.40	1.08	1.40
SWPA6020S220MT	22±20%	0.265	0.204	16	1.05	1.20	1.00	1.30
SWPA6020S330MT	33±20%	0.390	0.30	11	0.95	1.10	0.84	1.05
SWPA6020S470MT	47±20%	0.559	0.430	10	0.70	0.90	0.80	0.90

SWPA6028S Series

Part Number 型号	Inductance 电感量 @100kHz,1V	DC Resistance 直流电阻		Self-resonant Frequency 自谐频率	Saturation Current 饱和电流 ^{*3}		Heat Rating Current 温升电流 ^{*4}	
		Max.	Typ.		Max.	Typ.	Max.	Typ.
Units 单位	μH	Ω		MHz	A		A	
Symbol 符号	L	DCR		S.R.F	Isat		Irms	
SWPA6028SR82NT	0.82±30%	0.016	0.012	97	6.50	9.00	5.20	6.00
SWPA6028S1R0NT	1.0±30%	0.013	0.010	70	5.75	7.00	5.20	5.70
SWPA6028S1R2NT	1.2±30%	0.017	0.013	69	6.40	7.50	4.58	5.00
SWPA6028S1R5NT	1.5±30%	0.017	0.013	65	6.00	6.60	4.58	5.00
SWPA6028S2R2NT	2.2±30%	0.026	0.020	48	5.10	5.60	3.75	4.10
SWPA6028S2R7NT	2.7±30%	0.026	0.020	48	3.80	4.10	3.75	4.10
SWPA6028S3R3NT	3.3±30%	0.033	0.025	41	4.15	4.50	3.48	3.80
SWPA6028S4R7NT	4.7±30%	0.039	0.030	35	3.00	3.30	3.08	3.40
SWPA6028S5R1NT	5.1±30%	0.056	0.043	32	3.20	3.50	2.60	2.80
SWPA6028S6R2MT	6.2±20%	0.061	0.047	30	3.05	3.30	2.40	2.60
SWPA6028S6R8MT	6.8±20%	0.061	0.047	27	2.60	3.00	2.40	2.60
SWPA6028S8R2MT	8.2±20%	0.072	0.055	24	2.30	2.50	2.25	2.50
SWPA6028S9R1MT	9.1±20%	0.096	0.074	24	2.55	2.80	2.15	2.40
SWPA6028S100MT	10±20%	0.094	0.072	23	2.04	2.50	1.95	2.40
SWPA6028S120MT	12±20%	0.104	0.080	18	1.80	2.00	1.85	2.00
SWPA6028S150MT	15±20%	0.163	0.125	18	1.75	1.90	1.45	1.60
SWPA6028S180MT	18±20%	0.156	0.120	15	1.52	1.80	1.45	1.60
SWPA6028S220MT	22±20%	0.182	0.140	14	1.45	1.80	1.40	1.60
SWPA6028S270MT	27±20%	0.202	0.155	13	1.50	1.60	1.32	1.40
SWPA6028S330MT	33±20%	0.241	0.185	12	1.35	1.50	1.22	1.30
SWPA6028S360MT	36±20%	0.280	0.215	11	1.25	1.40	1.13	1.20
SWPA6028S390MT	39±20%	0.293	0.225	11	1.25	1.40	1.10	1.20
SWPA6028S470MT	47±20%	0.410	0.315	9.5	1.15	1.30	1.06	1.10
SWPA6028S560MT	56±20%	0.449	0.345	8.2	1.05	1.20	0.89	1.00

规格特性

SPECIFICATIONS

SWPA6028S Series

Part Number 型号	Inductance 电感量	DC Resistance 直流电阻		Self-resonant Frequency 自谐振频率	Saturation Current 饱和电流 ^{*3}		Heat Rating Current 温升电流 ^{*4}	
		Max.	Typ.		Max.	Typ.	Max.	Typ.
Units 单位	@100kHz,1V μH	Ω		MHz	A		A	
Symbol 符号	L	DCR		S.R.F	Isat		Irms	
SWPA6028S680MT	68±20%	0.468	0.360	7.7	0.80	0.95	0.86	0.95
SWPA6028S750MT	75±20%	0.533	0.410	7.7	0.90	0.99	0.81	0.90
SWPA6028S820MT	82±20%	0.650	0.50	7.7	0.80	0.88	0.70	0.77
SWPA6028S101MT	100±20%	0.650	0.50	7.1	0.65	0.71	0.70	0.77
SWPA6028S401MT	400±20%	2.808	2.160	2.8	0.30	0.33	0.40	0.45

SWPA6045S Series

Part Number 型号	Inductance 电感量	DC Resistance 直流电阻		Self-resonant Frequency 自谐振频率	Saturation Current 饱和电流 ^{*3}		Heat Rating Current 温升电流 ^{*4}	
		Max.	Typ.		Max.	Typ.	Max.	Typ.
Units 单位	@100kHz,1V μH	Ω		MHz	A		A	
Symbol 符号	L	DCR		S.R.F	Isat		Irms	
SWPA6045SR47NT	0.47±30%	0.008	0.006	155	15.00	16.50	6.50	6.60
SWPA6045SR56NT	0.56±30%	0.008	0.006	142	14.00	15.00	6.50	7.50
SWPA6045SR68NT	0.68±30%	0.008	0.006	99	11.00	12.00	5.70	6.50
SWPA6045SR82NT	0.82±30%	0.010	0.008	140	10.35	11.00	5.90	6.50
SWPA6045S1R0NT	1.0±30%	0.014	0.011	100	9.85	10.00	5.14	5.60
SWPA6045S1R2NT	1.2±30%	0.013	0.010	100	8.35	9.10	5.40	5.90
SWPA6045S1R3NT	1.3±30%	0.013	0.010	100	8.35	9.10	5.40	5.90
SWPA6045S1R5NT	1.5±30%	0.016	0.012	65	8.80	9.70	4.95	5.40
SWPA6045S1R8NT	1.8±30%	0.016	0.012	74	7.60	8.40	4.95	5.40
SWPA6045S2R2NT	2.2±30%	0.018	0.014	52	6.75	7.40	4.60	5.00
SWPA6045S2R3NT	2.3±30%	0.027	0.021	60	6.00	6.60	3.50	3.80
SWPA6045S2R7NT	2.7±30%	0.020	0.015	38	5.75	6.30	4.30	4.70
SWPA6045S3R0NT	3.0±30%	0.026	0.020	35	5.60	6.20	3.80	4.20
SWPA6045S3R3NT	3.3±30%	0.027	0.021	32	5.90	6.20	3.70	4.00
SWPA6045S3R6NT	3.6±30%	0.027	0.021	28	5.25	5.70	3.70	4.00
SWPA6045S4R3MT	4.3±20%	0.030	0.023	23	4.45	4.90	3.50	3.80
SWPA6045S4R5MT	4.5±20%	0.034	0.026	24	4.97	5.50	3.30	3.60
SWPA6045S4R7MT	4.7±20%	0.034	0.026	24	4.97	5.50	3.30	3.60
SWPA6045S5R1MT	5.1±20%	0.034	0.026	23	4.40	4.80	3.30	3.60
SWPA6045S5R6MT	5.6±20%	0.038	0.029	23	4.15	4.60	3.15	3.40
SWPA6045S6R2MT	6.2±20%	0.040	0.031	26	4.43	4.80	3.00	3.30
SWPA6045S6R3MT	6.3±20%	0.040	0.031	26	4.43	4.70	3.00	3.30
SWPA6045S6R8MT	6.8±20%	0.040	0.031	20	3.90	4.30	3.00	3.30
SWPA6045S7R5MT	7.5±20%	0.044	0.034	18	3.50	3.80	2.90	3.20
SWPA6045S8R2MT	8.2±20%	0.056	0.043	21	3.90	4.30	2.60	2.80
SWPA6045S9R1MT	9.1±20%	0.056	0.043	17	3.35	3.70	2.60	2.80
SWPA6045S100MT	10±20%	0.062	0.048	15	3.20	3.50	2.45	2.70
SWPA6045S120MT	12±20%	0.075	0.058	13	2.80	3.00	2.20	2.40
SWPA6045S150MT	15±20%	0.088	0.068	12	2.50	2.70	2.05	2.20
SWPA6045S180MT	18±20%	0.105	0.081	10	2.20	2.40	1.85	2.00
SWPA6045S220MT	22±20%	0.116	0.089	10	2.05	2.20	1.80	2.00
SWPA6045S270MT	27±20%	0.133	0.102	9.2	1.90	2.10	1.65	1.80
SWPA6045S300MT	30±20%	0.172	0.132	7.8	1.70	1.80	1.50	1.60
SWPA6045S330MT	33±20%	0.178	0.137	7.8	1.65	1.80	1.45	1.60

规格特性

SPECIFICATIONS

SWPA6045S Series

Part Number 型号	Inductance 电感量 @100kHz,1V	DC Resistance 直流电阻		Self-resonant Frequency 自谐频率	Saturation Current 饱和电流 ^{*3}		Heat Rating Current 温升电流 ^{*4}	
		Max.	Typ.		Min.	Max.	Typ.	Max.
Units 单位	μH	Ω		MHz	A		A	
Symbol 符号	L	DCR		S.R.F	Isat		Irms	
SWPA6045S360MT	36±20%	0.225	0.173	7.8	1.62	1.80	1.40	1.50
SWPA6045S390MT	39±20%	0.234	0.180	7.8	1.50	1.60	1.25	1.40
SWPA6045S430MT	43±20%	0.260	0.20	7.7	1.63	1.80	1.20	1.30
SWPA6045S470MT	47±20%	0.260	0.20	6.4	1.40	1.50	1.20	1.30
SWPA6045S510MT	51±20%	0.269	0.207	6.4	1.35	1.50	1.15	1.20
SWPA6045S560MT	56±20%	0.287	0.221	6.4	1.30	1.40	1.10	1.20
SWPA6045S620MT	62±20%	0.306	0.235	6.4	1.25	1.40	1.10	1.20
SWPA6045S680MT	68±20%	0.376	0.289	6.4	1.20	1.30	1.00	1.10
SWPA6045S750MT	75±20%	0.397	0.305	5	1.15	1.20	0.95	1.00
SWPA6045S820MT	82±20%	0.443	0.341	4.9	1.05	1.10	0.90	0.99
SWPA6045S910MT	91±20%	0.467	0.359	4.9	1.00	1.10	0.85	0.94
SWPA6045S101MT	100±20%	0.563	0.433	4.2	0.95	1.00	0.80	0.88
SWPA6045S121MT	120±20%	0.629	0.484	4.2	0.85	0.94	0.77	0.85
SWPA6045S151MT	150±20%	0.754	0.580	4.2	0.80	0.88	0.70	0.77
SWPA6045S221MT	220±20%	1.084	0.834	3.5	0.70	0.77	0.59	0.65
SWPA6045S331MT	330±20%	1.651	1.270	2.8	0.57	0.63	0.57	0.63
SWPA6045S471MT	470±20%	2.340	1.80	2.0	0.500	0.560	0.420	0.480
SWPA6045S681MT	680±20%	3.250	2.50	1.7	0.420	0.460	0.330	0.380

SWPA8040S Series

Part Number 型号	Inductance 电感量 @100kHz,1V	DC Resistance 直流电阻		Self-resonant Frequency 自谐频率	Saturation Current 饱和电流 ^{*3}		Heat Rating Current 温升电流 ^{*4}	
		Max.	Typ.		Min.	Max.	Typ.	Max.
Units 单位	μH	Ω		MHz	A		A	
Symbol 符号	L	DCR		S.R.F	Isat		Irms	
SWPA8040SR82NT	0.82±30%	0.010	0.008	94	13.80	16.00	6.30	6.90
SWPA8040S1R0NT	1.0±30%	0.010	0.008	89	9.85	14.00	6.30	6.90
SWPA8040S1R2NT	1.2±30%	0.013	0.010	59	10.00	14.00	5.65	6.20
SWPA8040S1R5NT	1.5±30%	0.013	0.010	67	8.15	11.00	5.65	6.20
SWPA8040S2R0NT	2.0±30%	0.016	0.012	43	9.25	10.00	5.15	5.60
SWPA8040S2R2NT	2.2±30%	0.016	0.012	41	7.10	8.00	5.15	5.60
SWPA8040S3R0NT	3.0±30%	0.018	0.014	32	6.10	7.00	4.70	5.20
SWPA8040S3R3NT	3.3±30%	0.022	0.017	27	6.50	7.00	4.40	4.80
SWPA8040S3R6NT	3.6±30%	0.022	0.017	30	7.52	8.50	4.35	4.80
SWPA8040S3R9NT	3.9±30%	0.022	0.017	26	5.75	6.50	4.35	4.80
SWPA8040S4R7NT	4.7±30%	0.025	0.019	24	5.90	6.50	4.10	4.50
SWPA8040S5R1NT	5.1±30%	0.025	0.019	22	4.70	5.40	4.05	4.40
SWPA8040S5R6NT	5.6±30%	0.027	0.021	24	6.00	6.90	3.85	4.20
SWPA8040S6R2NT	6.2±30%	0.027	0.021	20	4.45	5.10	3.85	4.20
SWPA8040S6R8MT	6.8±20%	0.031	0.024	20	4.55	5.20	3.60	4.00
SWPA8040S8R2MT	8.2±20%	0.034	0.026	17	4.20	4.80	3.45	3.80
SWPA8040S100MT	10±20%	0.038	0.029	15	3.60	4.10	3.30	3.60
SWPA8040S120MT	12±20%	0.053	0.041	13	3.50	4.00	2.80	3.00
SWPA8040S150MT	15±20%	0.061	0.047	12	2.95	3.40	2.60	2.80
SWPA8040S180MT	18±20%	0.069	0.053	11	2.70	3.10	2.40	2.60
SWPA8040S220MT	22±20%	0.090	0.069	9.5	2.40	2.70	2.10	2.30
SWPA8040S270MT	27±20%	0.101	0.078	9.2	2.15	2.50	2.00	2.20
SWPA8040S330MT	33±20%	0.126	0.097	7.8	2.05	2.40	1.80	2.00

规格特性

SPECIFICATIONS

SWPA8060S Series

Part Number 型号	Inductance 电感量 @100kHz,1V	DC Resistance 直流电阻		Self-resonant Frequency 自谐频率	Saturation Current 饱和电流 ^{*3}		Heat Rating Current 温升电流 ^{*4}	
		Max.	Typ.		Max.	Typ.	Max.	Typ.
Units 单位	μH	Ω		MHz	A		A	
Symbol 符号	L	DCR		S.R.F	Isat		Irms	
SWPA8040S360MT	36±20%	0.133	0.102	7.8	2.00	2.30	1.75	1.90
SWPA8040S390MT	39±20%	0.139	0.107	7.8	1.95	2.20	1.70	1.90
SWPA8040S430MT	43±20%	0.147	0.113	7.8	1.90	2.20	1.65	1.80
SWPA8040S470MT	47±20%	0.177	0.136	6.4	1.75	2.00	1.55	1.70
SWPA8040S510MT	51±20%	0.185	0.142	6.4	1.70	1.90	1.50	1.60
SWPA8040S560MT	56±20%	0.192	0.148	6.4	1.55	1.70	1.45	1.60
SWPA8040S620MT	62±20%	0.237	0.182	6.4	1.50	1.60	1.30	1.40
SWPA8040S680MT	68±20%	0.255	0.196	4.9	1.45	1.60	1.25	1.40
SWPA8040S750MT	75±20%	0.274	0.211	4.9	1.35	1.50	1.20	1.30
SWPA8040S820MT	82±20%	0.293	0.225	5.9	1.30	1.40	1.15	1.20
SWPA8040S910MT	91±20%	0.354	0.272	4.9	1.20	1.30	1.05	1.10
SWPA8040S101MT	100±20%	0.377	0.290	4.2	1.15	1.30	1.00	1.10
SWPA8040S121MT	120±20%	0.434	0.334	3.5	1.05	1.10	0.95	1.00
SWPA8040S151MT	150±20%	0.533	0.410	3.5	1.10	1.20	0.85	0.94
SWPA8040S181MT	180±20%	0.676	0.520	3.5	0.95	1.15	0.83	0.92
SWPA8040S221MT	220±20%	0.779	0.599	3.5	0.85	0.94	0.80	0.88
SWPA8040S331MT	330±20%	1.156	0.889	2.8	0.68	0.75	0.64	0.70
SWPA8040S471MT	470±20%	1.625	1.260	2.1	0.60	0.70	0.50	0.60

SWPA8060S Series

Part Number 型号	Inductance 电感量 @100kHz,1V	DC Resistance 直流电阻		Self-resonant Frequency 自谐频率	Saturation Current 饱和电流 ^{*3}		Heat Rating Current 温升电流 ^{*4}	
		Max.	Typ.		Max.	Typ.	Max.	Typ.
Units 单位	μH	Ω		MHz	A		A	
Symbol 符号	L	DCR		S.R.F	Isat		Irms	
SWPA8060S681KTY01	680±10%	2.17	1.81	1.26	0.72	0.82	0.46	0.53

SWPA8065S Series

Part Number 型号	Inductance 电感量 @100kHz,1V	DC Resistance 直流电阻		Self-resonant Frequency 自谐频率	Saturation Current 饱和电流 ^{*3}		Heat Rating Current 温升电流 ^{*4}	
		Max.	Typ.		Max.	Typ.	Max.	Typ.
Units 单位	μH	Ω		MHz	A		A	
Symbol 符号	L	DCR		S.R.F	Isat		Irms	
SWPA8065S1R0MT	1.0±20%	0.011	0.008	96	20.0	22.0	7.00	8.00
SWPA8065S3R3MT	3.3±20%	0.018	0.015	27	9.50	10.00	5.10	5.90
SWPA8065S4R7MT	4.7±20%	0.022	0.018	18	8.50	9.50	4.70	5.40
SWPA8065S5R6MT	5.6±20%	0.026	0.022	17	8.00	9.00	4.50	5.20
SWPA8065S6R8MT	6.8±20%	0.026	0.022	16	7.50	8.00	4.50	5.20
SWPA8065S8R2MT	8.2±20%	0.031	0.026	15	7.00	7.70	4.20	4.80
SWPA8065S100MT	10±20%	0.044	0.037	13	8.00	8.90	3.20	3.70
SWPA8065S220MT	22±20%	0.072	0.060	8	4.30	4.80	2.70	3.10
SWPA8065S101MT	100±20%	0.028	0.233	3.1	2.00	2.40	1.35	1.45
SWPA8065S151MT	150±20%	0.440	0.353	2.5	1.60	2.00	0.95	1.10
SWPA8065S221MT	220±20%	0.656	0.547	2.0	1.20	1.50	0.80	0.90
SWPA8065S331MT	330±20%	0.840	0.700	1.7	1.00	1.20	0.75	0.85
SWPA8065S431MT	430±20%	1.20	1.00	1.5	0.95	1.05	0.61	0.69

- ※1: All test data is referenced to 20 °C ambient;
- ※2: Rated current: Isat or Irms, whichever is smaller;
- ※*3: Isat: DC current at which the inductance drops approximate 30% from its value without current;
- ※*4: Irms: DC current that causes the temperature rise ($\Delta T = 40^\circ\text{C}$) from 20 °C ambient.

电气特性

TYPICAL ELECTRICAL CHARACTERISTICS

SWPA252010S Series

Temperature vs. DC Current Characteristics



Inductance vs. DC Current Characteristics



SWPA252012S Series

Temperature vs. DC Current Characteristics



Inductance vs. DC Current Characteristics



SWPA3010S Series

Temperature vs. DC Current Characteristics



Inductance vs. DC Current Characteristics



SWPA3012S Series

Temperature vs. DC Current Characteristics



Inductance vs. DC Current Characteristics



电气特性

TYPICAL ELECTRICAL CHARACTERISTICS

SWPA3015S Series

Temperature vs. DC Current Characteristics



Inductance vs. DC Current Characteristics



SWPA4010S Series

Temperature vs. DC Current Characteristics

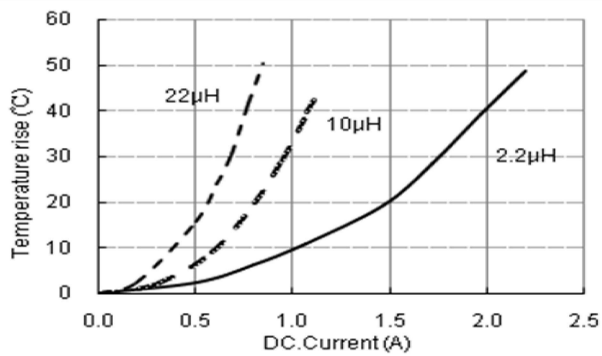

Inductance vs. DC Current Characteristic



SWPA4012S Series

Temperature vs. DC Current Characteristics

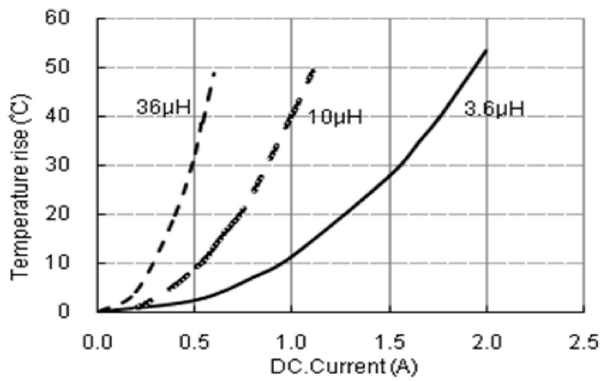

Inductance vs. DC Current Characteristic



SWPA4018S Series

Temperature vs. DC Current Characteristics

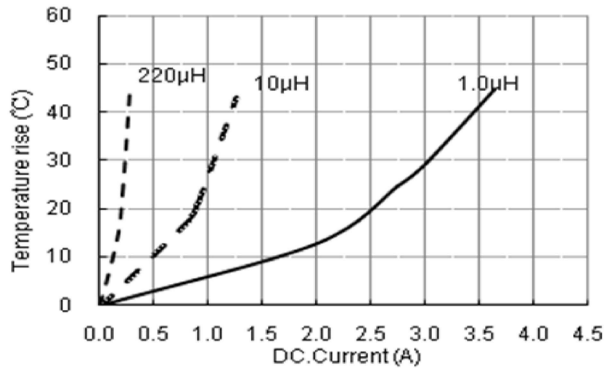

Inductance vs. DC Current Characteristics



电气特性

TYPICAL ELECTRICAL CHARACTERISTICS

SWPA4020S Series

Temperature vs. DC Current Characteristics



Inductance vs. DC Current Characteristics



SWPA4030S Series

Temperature vs. DC Current Characteristics



Inductance vs. DC Current Characteristics



SWPA5012S Series

Temperature vs. DC Current Characteristics



Inductance vs. DC Current Characteristics



SWPA5020S Series

Temperature vs. DC Current Characteristics



Inductance vs. DC Current Characteristics



电气特性

TYPICAL ELECTRICAL CHARACTERISTICS

SWPA5040S Series

Temperature vs. DC Current Characteristics



Inductance vs. DC Current Characteristics

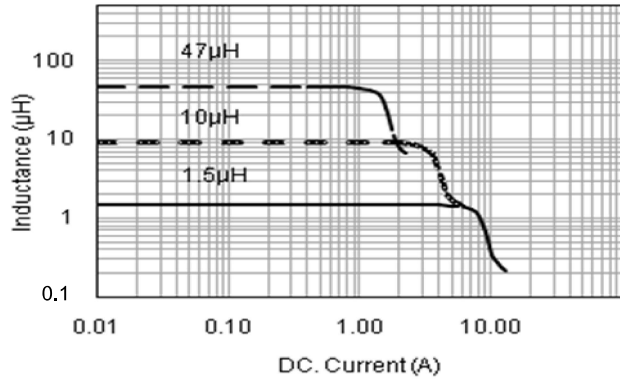

SWPA6020S Series

Temperature vs. DC Current Characteristics



Inductance vs. DC Current Characteristics

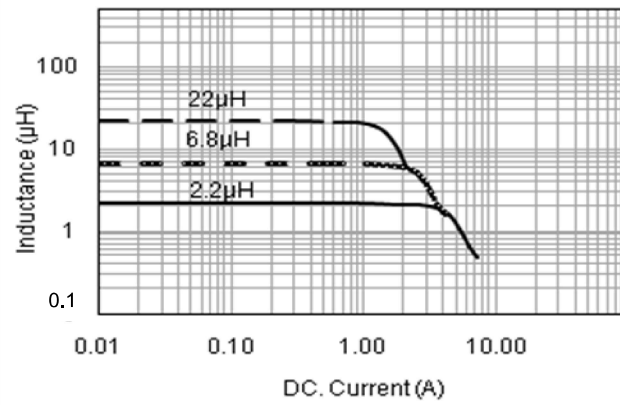

SWPA6028S Series

Temperature vs. DC Current Characteristics



Inductance vs. DC Current Characteristics

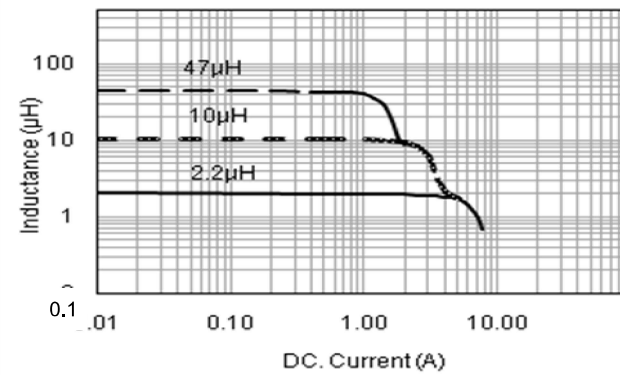

SWPA6045S Series

Temperature vs. DC Current Characteristics

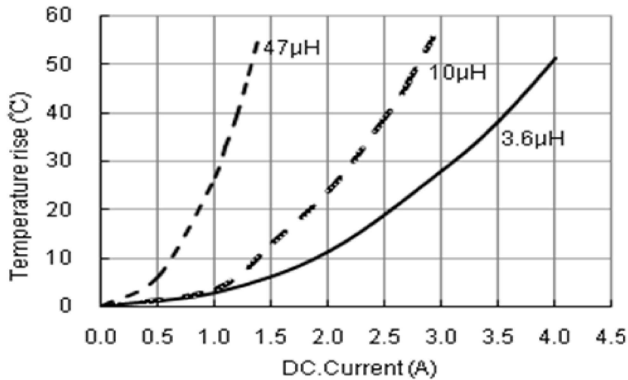

Inductance vs. DC Current Characteristics

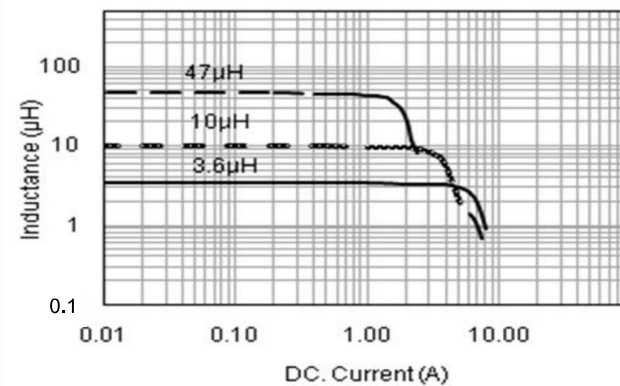

SWPA8040S Series

Temperature vs. DC Current Characteristics



Inductance vs. DC Current Characteristics



SWPA8065S Series

Temperature vs. DC Current Characteristics



Inductance vs. DC Current Characteristics



Looking for pricing, stock, or lifecycle information?

Click below to explore more details on WIN SOURCE:

 [View SWPA5020S680MT on WIN SOURCE](#)

 [Sunlord Information](#)

Optimize Your Supply Chain with WIN SOURCE Solutions

-  Global Sourcing Solution
-  Obsolete Management
-  Cost Control Management
-  Shortage Management
-  Alternative Solution
-  Excess Inventory Management