



**THE DATASHEET OF
BKPA002012104R7M00**



SMD Multilayer Power Inductors

BKPA/BKPB/BKPE Series



The BKPx Series is a miniature type of multilayer power inductor constructed using low-loss ferrite material to support high-speed switching frequencies. The compact size and high efficiency is ideal for DC-DC converter applications in space-limited boards.

Features

- RoHS, Halogen Free and REACH Compliance
- Small size
- Low profile
- High current
- Magnetically shielded configuration allowing for high density mounting

Applications

- DC-DC converters
- Power modules
- Cellular phones
- DSC, PND, DVD
- Wireless card and other electronic devices

Product Identification

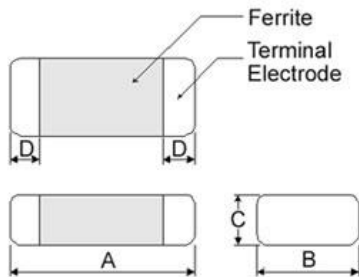
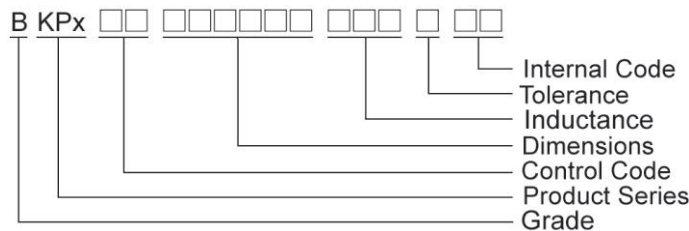

Dimensions in mm

TYPE	A	B	C	D
1608FZ	1.6±0.15	0.8±0.15	0.6±0.15	0.3±0.2
1608DZ	1.6±0.15	0.8±0.15	0.8±0.15	0.3±0.2
201210	2.0±0.20	1.25±0.20	1.0 Max	0.5±0.3
201610	2.0±0.20	1.6±0.20	1.0 Max	0.5±0.3
252010	2.5±0.20	2.0±0.20	1.0 Max	0.6±0.2
252012	2.5±0.20	2.0±0.20	1.2 Max	0.6±0.2

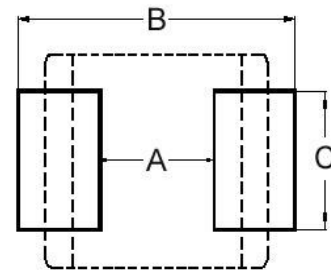

Dimensions in mm

TYPE	A	B	C
1608FZ	0.7 ~ 0.8	1.8 ~ 2.0	0.6 ~ 0.8
1608DZ	0.7 ~ 0.8	1.8 ~ 2.0	0.6 ~ 0.8
201210	0.8 ~ 1.2	2.3 ~ 2.9	1.0 ~ 1.4
201610	0.8 ~ 1.2	2.1 ~ 2.7	1.6 ~ 2.0
252010	1.3 ~ 1.9	2.7 ~ 3.5	2.0 ~ 2.6
252012	1.3 ~ 1.9	2.7 ~ 3.5	2.0 ~ 2.6

Electrical Characteristics

Part Number	Inductance (μH)	Tolerance ($\pm\%$)	Test Frequency (MHz)	RDC (Ω) $\pm 30\%$	Rated current (mA) Max
BKPA002012101R0□00	1.0	20, 30	1	0.18	1100
BKPA002012101R5□00	1.5	20, 30	1	0.19	1000
BKPA002012102R2□00	2.2	20, 30	1	0.22	900
BKPA002012103R3□00	3.3	20, 30	1	0.25	700
BKPA002012104R7□00	4.7	20, 30	1	0.35	600

Note: When ordering, please specify tolerance code. Tolerance: M= $\pm 20\%$, T= $\pm 30\%$

- Operating temperature range - 55°C ~ 125°C(Including self - temperature rise)
- Rated Current for a 40°C temperature rise from 25°C ambient with current
- Measure Equipment :
 L : Agilent HP4287A+16197A, 1MHz 200mV
 RDC : HP 4338B, or equivalent

Test Instruments : HP4287A Inductance / Material Analyzer

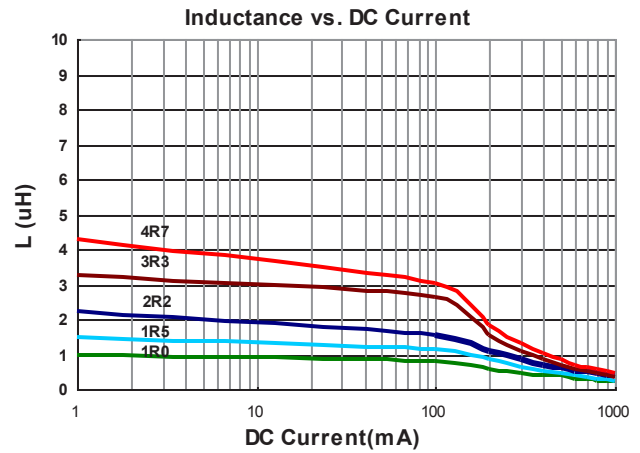
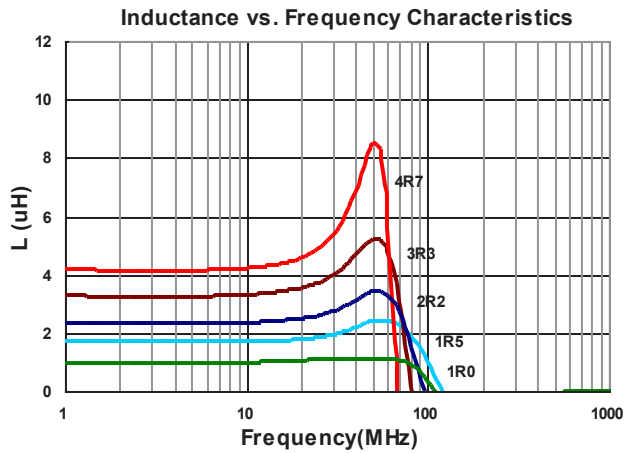

Electrical Characteristics

Part Number	Inductance (μH)	Tolerance ($\pm\%$)	Test Frequency (MHz)	RDC (Ω) $\pm 30\%$	Rated current (mA) Max
BKPA002520101R0□00	1.0	20, 30	1	0.11	1200
BKPA002520101R5□00	1.5	20, 30	1	0.13	1100
BKPA002520102R2□00	2.2	20, 30	1	0.15	1000
BKPA002520103R3□00	3.3	20, 30	1	0.18	1000
BKPA002520104R7□00	4.7	20, 30	1	0.25	900

Note: When ordering, please specify tolerance code. Tolerance: M= $\pm 20\%$, T= $\pm 30\%$

- Operating temperature range - 55°C ~ 125°C(Including self - temperature rise)
- Rated Current for a 40°C temperature rise from 25°C ambient with current
- Measure Equipment :
 - L : Agilent HP4287A+16197A, 1MHz 200mV
 - RDC : HP 4338B, or equivalent

Test Instruments : HP4287A Inductance / Material Analyzer

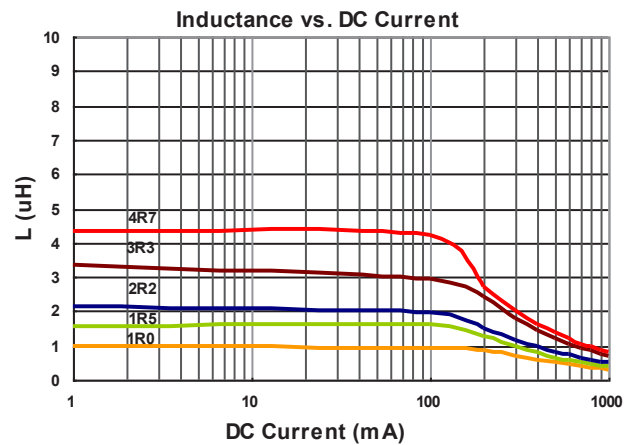
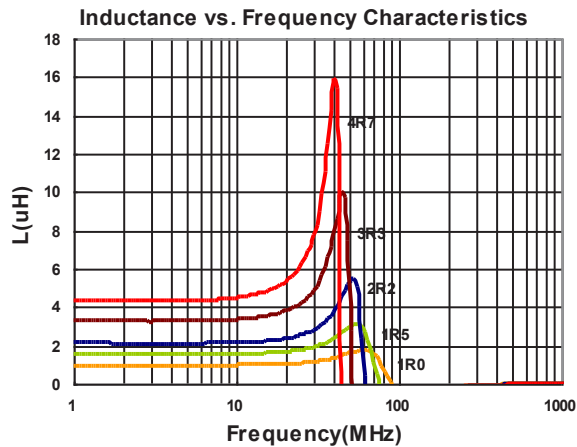

Electrical Characteristics

Part Number	Inductance (μH)	Tolerance ($\pm\%$)	Test Frequency (MHz)	RDC (Ω) $\pm 30\%$	Isat (mA) Max	Irms (mA) Max
BKPB001608DZR47□A2	0.47	20, 30	3	0.15	400	1100
BKPB001608DZ1R0□A2	1.0	20, 30	3	0.20	200	950
BKPB001608DZ2R2□A2	2.2	20, 30	3	0.30	150	750
BKPB001608DZ4R7□A6	4.7	20	3	0.44 $\pm 25\%$	80	800

Note: When ordering, please specify tolerance code. Tolerance: M= $\pm 20\%$, T= $\pm 30\%$

- Operating temperature range - 55°C ~ 125°C(Including self - temperature rise)
- Isat for Inductance drop 30% from its value without current
- I rms for a 40°C temperature rise from 25°C ambient with current
- Measure Equipment :
L : Agilent HP4287A+16197A, 3MHz 200mV
RDC : HP 4338B, or equivalent

Test Instruments : HP4287A Inductance / Material Analyzer

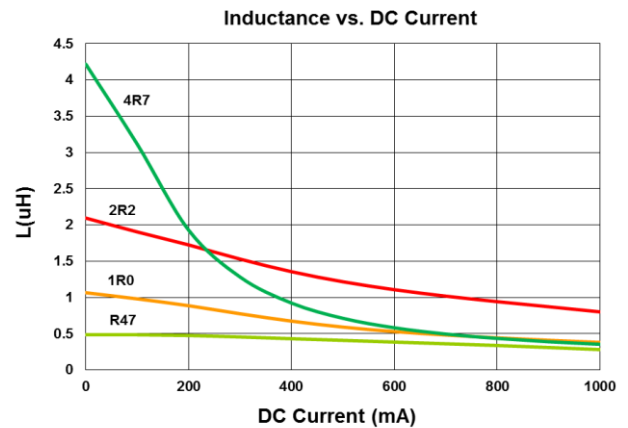
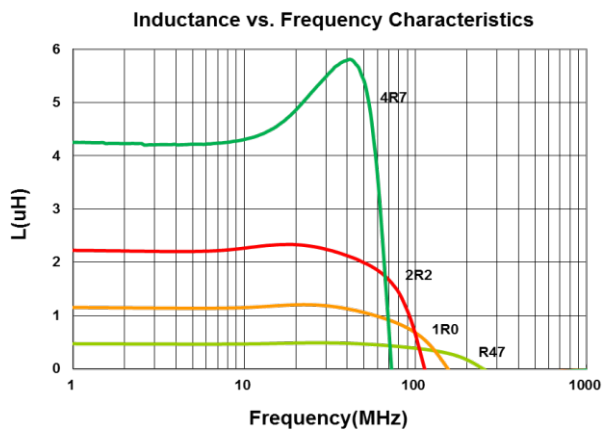

Electrical Characteristics

Part Number	Inductance (μH)	Tolerance ($\pm\%$)	Test Frequency (MHz)	RDC (Ω) $\pm 30\%$	Isat (mA) Max	Irms (mA) Max
BKPB00201210R47□A2	0.47	20, 30	3	0.09	1100	1300
BKPB002012101R0□A2	1.0	20, 30	3	0.12	650	1200
BKPB002012101R5□A2	1.5	20, 30	3	0.15	450	1100
BKPB002012102R2□A2	2.2	20, 30	3	0.19	400	1100
BKPB002012102R7□A2	2.7	20, 30	3	0.21	300	1000
BKPB002012103R3□A2	3.3	20, 30	3	0.24	300	800
BKPB002012104R7□A2	4.7	20, 30	3	0.26	200	700

Note: When ordering, please specify tolerance code. Tolerance: M= $\pm 20\%$, T= $\pm 30\%$

- Operating temperature range - 55°C ~ 125°C (Including self - temperature rise)
- Isat for Inductance drop 30% from its value without current
- I rms for a 40°C temperature rise from 25°C ambient with current
- Measure Equipment :
L : Agilent HP4287A+16197A, 3MHz 200mV
RDC : HP 4338B, or equivalent

Test Instruments : HP4287A Inductance / Material Analyzer

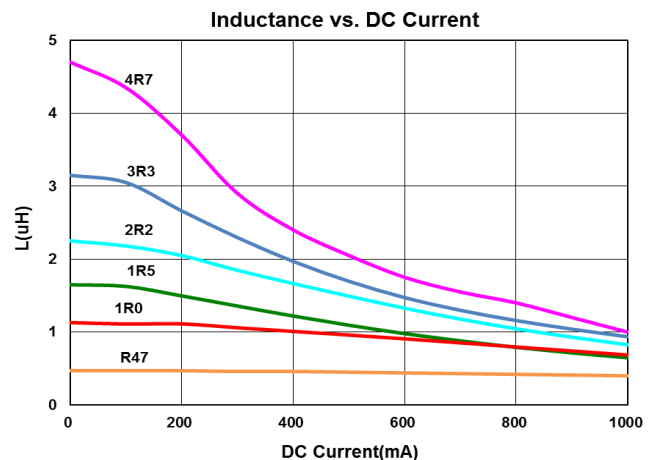
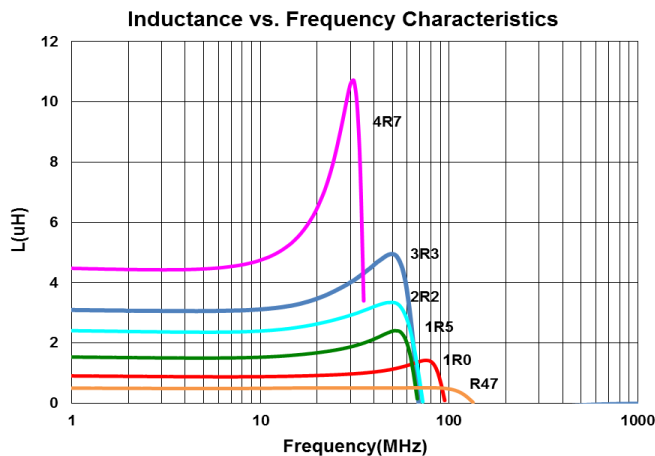

Electrical Characteristics

Part Number	Inductance (uH)	Tolerance (±%)	Test Frequency (MHz)	RDC (Ω)	Isat (mA) Max	Irms (mA) Max
BKPB00201610R47□A2	0.47	20, 30	3	0.06±30%	1200	1600
BKPB002016101R0□A2	1.0	20, 30	3	0.09±30%	850	1300
BKPB002016102R2□A2	2.2	20, 30	3	0.13±30%	400	1000
BKPB002016103R3□A2	3.3	20, 30	3	0.17±30%	350	850
BKPB002016104R7□A2	4.7	20, 30	3	0.21±30%	200	800
BKPB00201610R47□A6	0.47	20, 30	3	0.06±25%	1200	1600
BKPB002016101R0□A6	1.0	20, 30	3	0.085±25%	850	1300
BKPB002016101R5□A6	1.5	20, 30	3	0.11±25%	600	1200
BKPB002016102R2□A6	2.2	20, 30	3	0.11±25%	400	1200
BKPB002016103R3□A6	3.3	20, 30	3	0.12±25%	350	850
BKPB002016104R7□A6	4.7	20, 30	3	0.14±25%	200	1100

Note: When ordering, please specify tolerance code. Tolerance: M=±20% , T=±30%

- Operating temperature range - 55°C ~ 125°C(Including self - temperature rise)
- Isat for Inductance drop 30% from its value without current
- I rms for a 40°C temperature rise from 25°C ambient with current
- Measure Equipment :
 L : Agilent HP4287A+16197A, 3MHz 200mV
 RDC : HP 4338B, or equivalent

Test Instruments : HP4287A Inductance / Material Analyzer

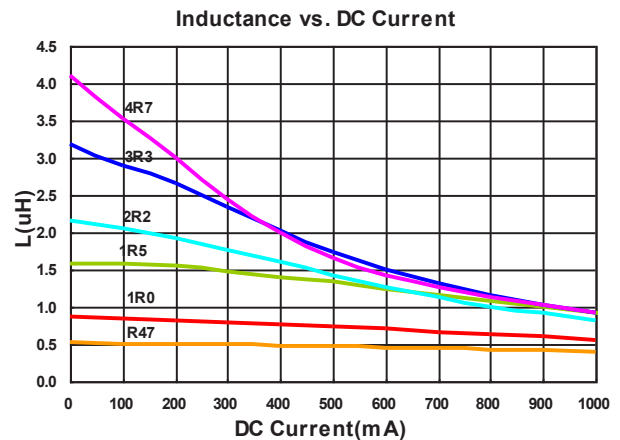
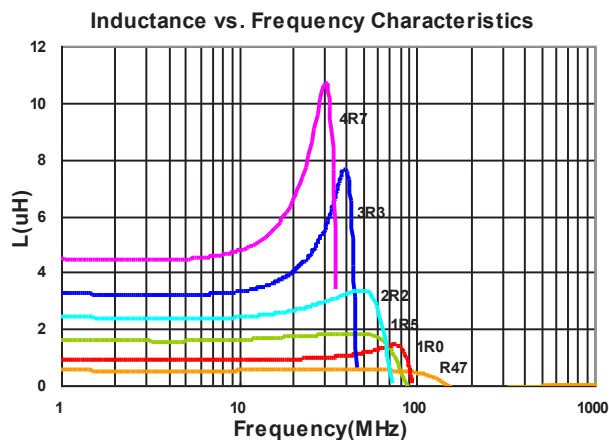

Electrical Characteristics

Part Number	Inductance (μH)	Tolerance ($\pm\%$)	Test Frequency (MHz)	RDC (Ω)	Isat (mA) Max	Irms (mA) Max
BKPB00252010R47□A2	0.47	20, 30	3	0.04 \pm 30%	1500	1800
BKPB002520101R0□A2	1.0	20, 30	3	0.06 \pm 30%	900	1500
BKPB002520101R5□A2	1.5	20, 30	3	0.07 \pm 30%	800	1400
BKPB002520102R2□A2	2.2	20, 30	3	0.10 \pm 30%	500	1200
BKPB002520103R3□A2	3.3	20, 30	3	0.12 \pm 30%	400	1100
BKPB002520104R7□A2	4.7	20, 30	3	0.14 \pm 30%	300	1000
BKPB00252010R47□A6	0.47	20, 30	3	0.04 \pm 25%	1500	1800
BKPB002520101R0□A6	1.0	20, 30	3	0.055 \pm 25%	900	1600
BKPB002520102R2□A6	2.2	20, 30	3	0.08 \pm 25%	500	1300
BKPB002520103R3□A6	3.3	20, 30	3	0.10 \pm 25%	400	1200
BKPB002520104R7□A6	4.7	20, 30	3	0.11 \pm 25%	300	1100

Note: When ordering, please specify tolerance code. Tolerance: M= \pm 20% , T= \pm 30%

- Operating temperature range - 55°C ~ 125°C(Including self - temperature rise)
- Isat for Inductance drop 30% from its value without current
- I rms for a 40°C temperature rise from 25°C ambient with current
- Measure Equipment :
L : Agilent HP4287A+16197A, 3MHz 200mV
RDC : HP 4338B, or equivalent

Test Instruments : HP4287A Inductance / Material Analyzer

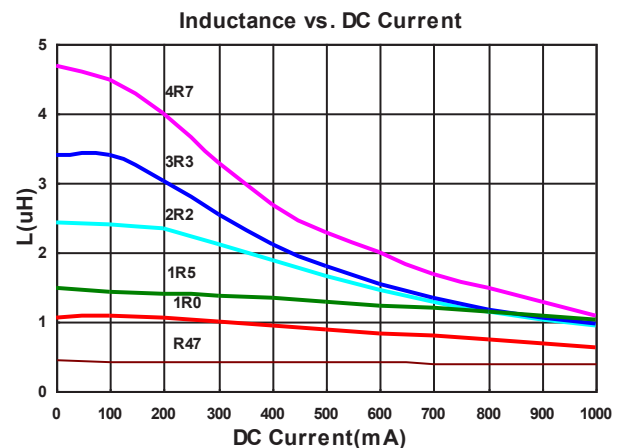
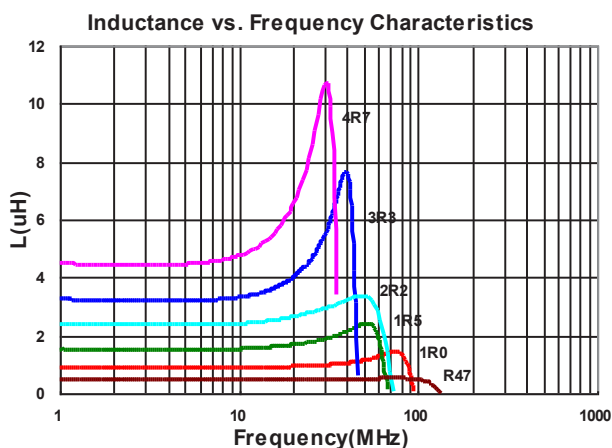

Electrical Characteristics

Part Number	Inductance (μH)	Tolerance ($\pm\%$)	Test Frequency (MHz)	RDC (Ω) $\pm 30\%$	Isat (mA) Max	Irms (mA) Max
BKPB00252012R47□A2	0.47	20, 30	3	0.04	1500	1800
BKPB002520121R0□A2	1.0	20, 30	3	0.05	950	1600
BKPB002520121R5□A2	1.5	20, 30	3	0.07	900	1400
BKPB002520122R2□A2	2.2	20, 30	3	0.10	700	1200
BKPB002520123R3□A2	3.3	20, 30	3	0.12	500	1100
BKPB002520124R7□A2	4.7	20, 30	3	0.14	350	1000

Note: When ordering, please specify tolerance code. Tolerance: M $\pm 20\%$, T $\pm 30\%$

- Operating temperature range - 55°C ~ 125°C(Including self - temperature rise)
- Isat for Inductance drop 30% from its value without current
- I rms for a 40°C temperature rise from 25°C ambient with current
- Measure Equipment :
L : Agilent HP4287A+16197A, 3MHz 200mV
RDC : HP 4338B, or equivalent

Test Instruments : HP4287A Inductance / Material Analyzer

Inductance vs. Frequency Characteristics

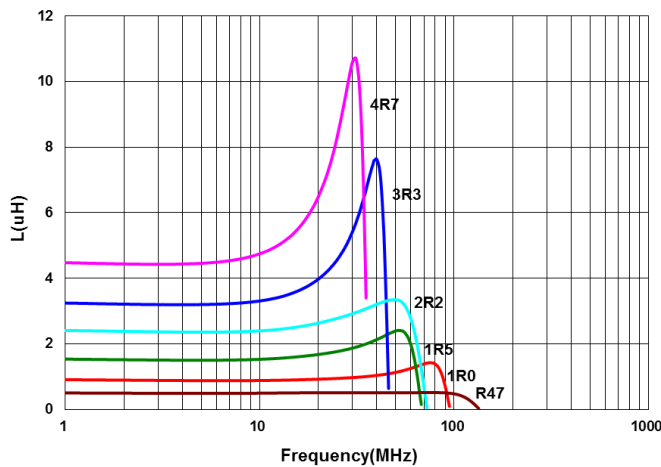

Inductance vs. DC Current

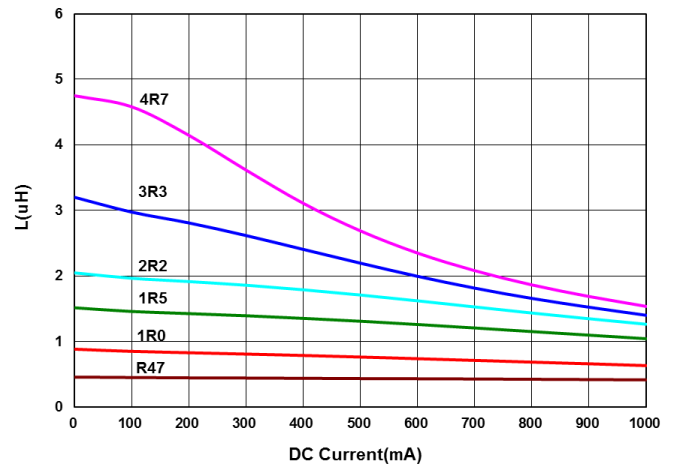

Electrical Characteristics

Part Number	Inductance (μH)	Tolerance ($\pm\%$)	Test Frequency (MHz)	RDC (Ω) $\pm 25\%$	Isat(mA) Max(Typ.)	Irms(mA) Max(Typ.)
BKPE001608FZ2R2□A6	2.2	20, 30	3	0.38	250(300)	650(750)

Note: When ordering, please specify tolerance code. Tolerance: M=±20% , T=±30%

- Operating temperature range - 55°C ~ 125°C(Including self - temperature rise)
- Isat for Inductance drop 30% from its value without current
- I rms for a 40°C temperature rise from 25°C ambient with current
- Measure Equipment :
L : Agilent HP4287A+16197A, 3MHz 200mV
RDC : HP 4338B, or equivalent

Test Instruments : HP4287A Inductance / Material Analyzer

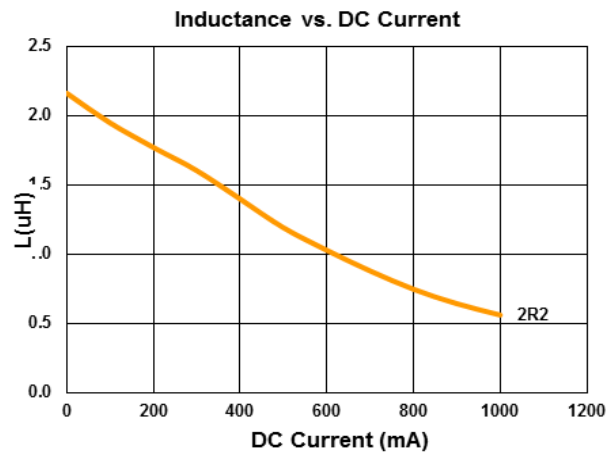
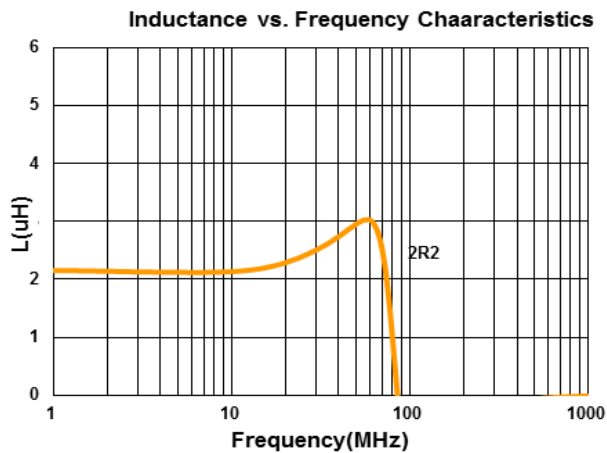

Electrical Characteristics

Part Number	Inductance (μH)	Tolerance ($\pm\%$)	Test Frequency (MHz)	RDC (Ω) $\pm 25\%$	Isat(mA) Max(Typ.)	Irms(mA) Max(Typ.)
BKPE001608DZ1R0□A6	1.0	20, 30	3	0.13	500(650)	1300(1450)
BKPE001608DZ2R2□A6	2.2	20, 30	3	0.38	300(350)	700(900)

Note: When ordering, please specify tolerance code. Tolerance: M= $\pm 20\%$, T= $\pm 30\%$

- Operating temperature range - 55°C ~ 125°C(Including self - temperature rise)
- Isat for Inductance drop 30% from its value without current
- Irms for a 40°C temperature rise from 25°C ambient with current
- Measure Equipment :
L : Agilent HP4287A+16197A, 3MHz 200mV
RDC : HP 4338B, or equivalent

Test Instruments : HP4287A Inductance / Material Analyzer

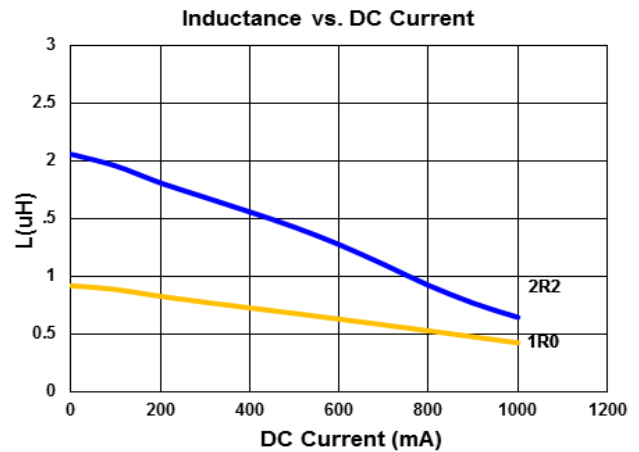
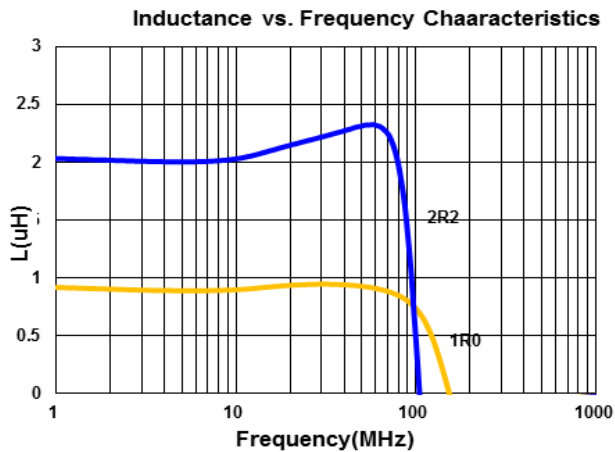

Electrical Characteristics

Part Number	Inductance (μH)	Tolerance ($\pm\%$)	Test Frequency (MHz)	RDC (Ω) $\pm 25\%$	Isat(mA) Max(Typ.)	Irms(mA) Max(Typ.)
BKPE00201210R24□A2	0.24	20, 30	3	0.03	2700(3300)	2400(3200)
BKPE00201210R47□A2	0.47	20, 30	3	0.06	1600(2000)	2200(3000)
BKPE002012101R0□A2	1.0	20, 30	3	0.10	1400(1700)	1800(2100)
BKPE002012102R2□A2	2.2	20, 30	3	0.125	500(800)	1600(1900)

Note: When ordering, please specify tolerance code. Tolerance: M=±20% , T=±30%

- Operating temperature range - 55°C ~ 125°C(Including self - temperature rise)
- Isat for Inductance drop 30% from its value without current
- I rms for a 40°C temperature rise from 25°C ambient with current
- Measure Equipment :
L : Agilent HP4287A+16197A, 3MHz 200mV
RDC : HP 4338B, or equivalent

Test Instruments : HP4287A Inductance / Material Analyzer

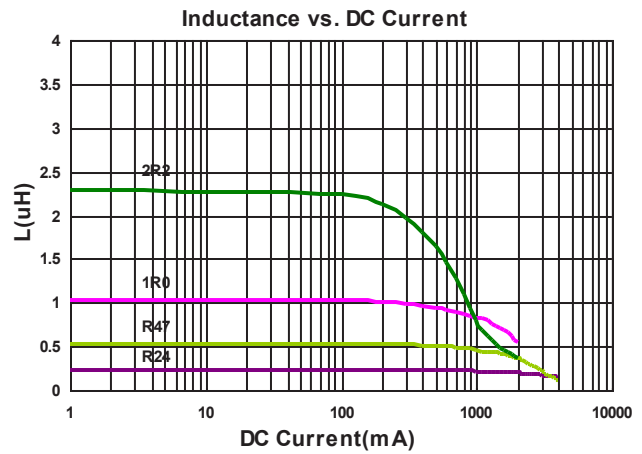
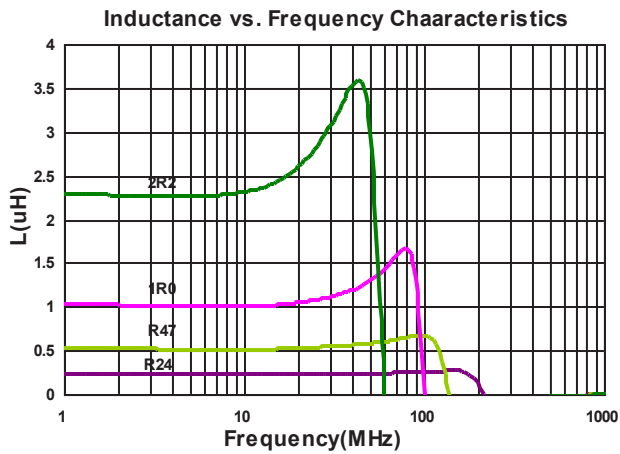

Electrical Characteristics

Part Number	Inductance (μH)	Tolerance ($\pm\%$)	Test Frequency (MHz)	RDC (Ω) $\pm 25\%$	Isat(mA) Max(Typ.)	Irms(mA) Max(Typ.)
BKPE00201610R24□A2	0.24	20, 30	3	0.023	3600(4000)	3500(4200)
BKPE00201610R47□A2	0.47	20, 30	3	0.037	2500(2900)	2600(3100)
BKPE00201610R68□A2	0.68	20, 30	3	0.065	2500(2800)	2400(2800)
BKPE002016101R0□A2	1.0	20, 30	3	0.068	1500(1900)	2200(2600)
BKPE002016101R5□A2	1.5	20, 30	3	0.100	1500(1800)	1600(1900)
BKPE002016102R2□A2	2.2	20, 30	3	0.210	1000(1300)	1500(1800)

Note: When ordering, please specify tolerance code. Tolerance: M= $\pm 20\%$, T= $\pm 30\%$

- Operating temperature range - 55°C ~ 125°C(Including self - temperature rise)
- Isat for Inductance drop 30% from its value without current
- I rms for a 40°C temperature rise from 25°C ambient with current
- Measure Equipment :
L : Agilent HP4287A+16197A, 3MHz 200mV
RDC : HP 4338B, or equivalent

Test Instruments : HP4287A Inductance / Material Analyzer

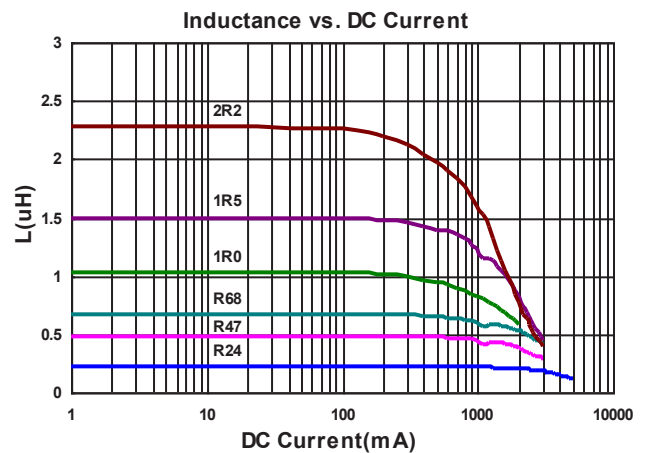
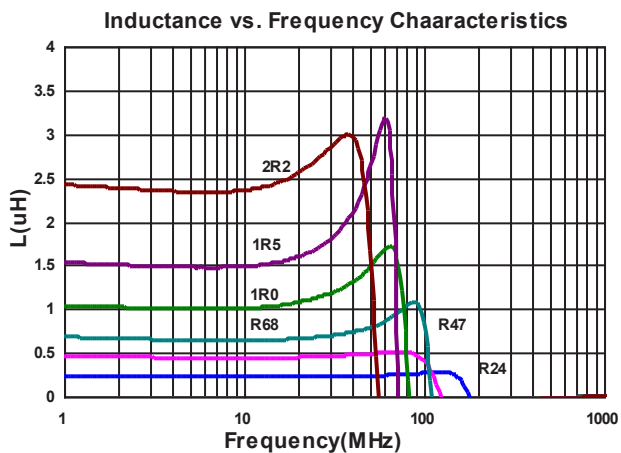

Electrical Characteristics

Part Number	Inductance (μH)	Tolerance ($\pm\%$)	Test Frequency (MHz)	RDC (Ω) $\pm 25\%$	Isat(mA) Max(Typ.)	Irms(mA) Max(Typ.)
BKPE00252010R24□A2	0.24	20, 30	3	0.024	4800(5200)	4100(4900)
BKPE00252010R47□A2	0.47	20, 30	3	0.040	3100(3500)	3000(3600)
BKPE002520101R0□A2	1.0	20, 30	3	0.050	1500(1900)	2900(3500)
BKPE002520102R2□A2	2.2	20, 30	3	0.110	1400(1700)	1600(1900)

Note: When ordering, please specify tolerance code. Tolerance: M= $\pm 20\%$, T= $\pm 30\%$

- Operating temperature range - 55°C ~ 125°C(Including self - temperature rise)
- Isat for Inductance drop 30% from its value without current
- I rms for a 40°C temperature rise from 25°C ambient with current
- Measure Equipment :

L : Agilent HP4287A+16197A, 3MHz 200mV

RDC : HP 4338B, or equivalent

Test Instruments : HP4287A Inductance / Material Analyzer

Inductance vs. Frequency Characteristics

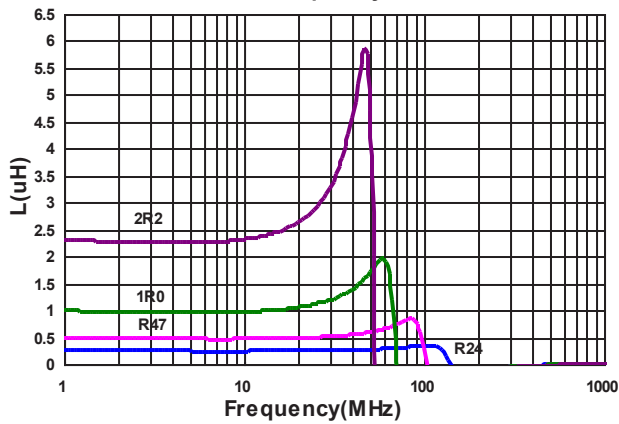

Inductance vs. DC Current

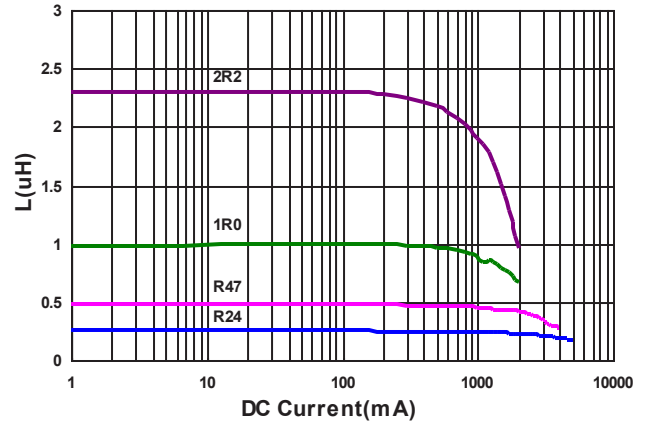

SMD Multilayer Power Inductors

BKPA/BKPB/BKPE Series

Packaging Specifications

Tape Dimensions

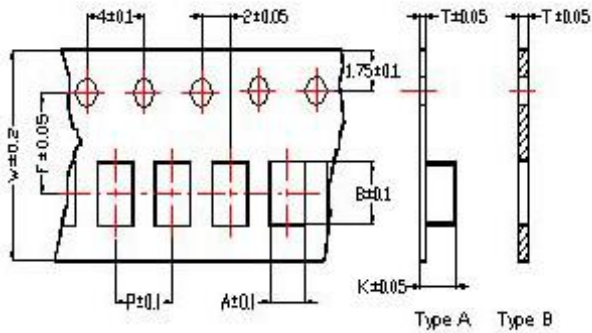

Tape Material

Carrier Tape: Polycarbonate (Tape A)
Carrier Tape: Paper (Tape B)
Cover Tape: Polystyrene

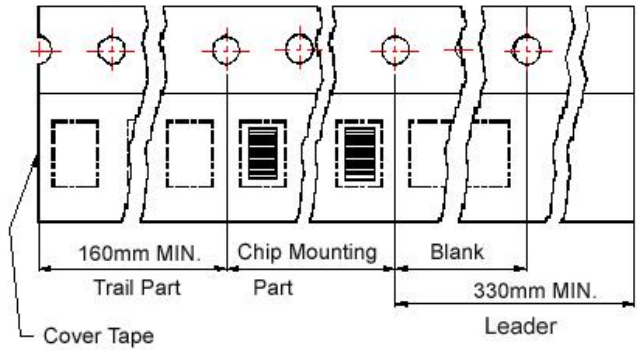

Reel Dimensions

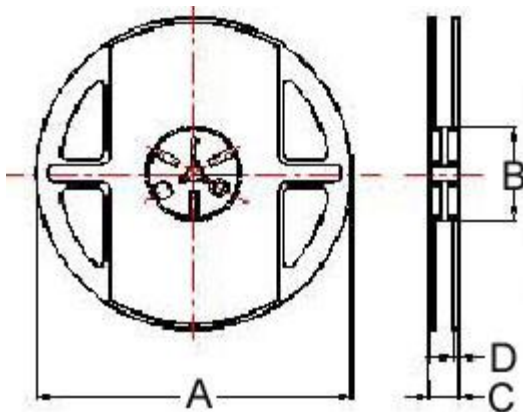

Dimensions in mm

TYPE	Tape Dimensions								Reel Dimensions				Quantity PCS / REEL
	A	B	T	W	P	F	K	Tape Type	A	B	C	D	
1608FZ	1.05	1.85	0.75	8.0	4.0	3.5	-	B	178	60	12	1.5	4000
1608DZ	1.05	1.85	0.95	8.0	4.0	3.5	-	B	178	60	12	1.5	4000
201210	1.45	2.25	0.22	8.0	4.0	3.5	1.04	A	178	60	12	1.5	3000
201610	1.80	2.20	0.22	8.0	4.0	3.5	1.15	A	178	60	12	1.5	3000
252010	2.25	2.8	0.25	8.0	4.0	3.5	1.35	A	178	60	12	1.5	3000
252012	2.25	2.8	0.25	8.0	4.0	3.5	1.35	A	178	60	12	1.5	3000



The BKPB Series is a miniature type of multilayer power inductor constructed using low-loss ferrite material to support high-speed switching frequencies. The compact size and high efficiency is ideal for DC-DC converter applications in space-limited boards.

Features

- For High Frequency SW (15MHz to 200MHz)
- Bias Current Characteristics improved.
- Low Power loss
- High DC Bias
- High Current
- Low ACR

Applications

- High Frequency DC/DC converter.

Product Identification

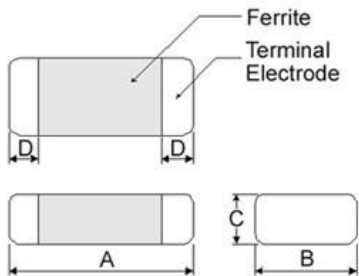
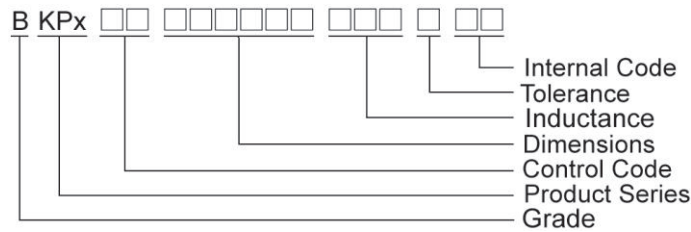

Dimensions in mm

TYPE	A	B	C	D
2012C5	2.0±0.20	1.25±0.20	0.95 Max	0.5±0.3

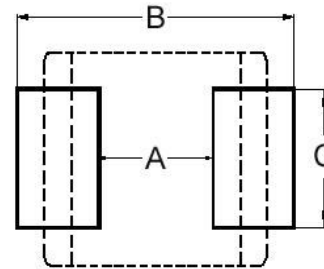

Dimensions in mm

TYPE	A	B	C
2012C5	0.8 ~ 1.2	2.3 ~ 2.9	1.0 ~ 1.4

Electrical Characteristics

Part Number	Inductance (μH)	Tolerance ($\pm\%$)	Test Frequency (MHz)	RDC (Ω) $\pm 30\%$	Isat (mA) Max	Irms (mA) Max
BKPB002012C522N□A2	0.022	10, 20	50	0.044	3000	2000
BKPB002012C533N□A2	0.033	10, 20	50	0.050	2700	1800
BKPB002012C547N□A2	0.047	10, 20	50	0.058	2400	1600

Note: When ordering, please specify tolerance code. Tolerance: K= $\pm 10\%$, M= $\pm 20\%$

- Operating temperature range - 55°C ~ 125°C(Including self - temperature rise)
- Isat for Inductance drop 30% from its value without current
- I rms for a 40°C temperature rise from 25°C ambient with current
- Measure Equipment :
L : Agilent E4991A+16197A, 50MHz 200mV
RDC : HP 4338B, or equivalent

Test Instruments : E4991A Inductance / Material Analyzer

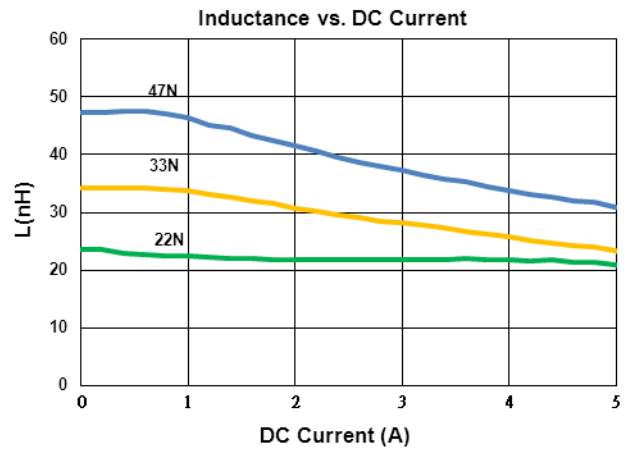
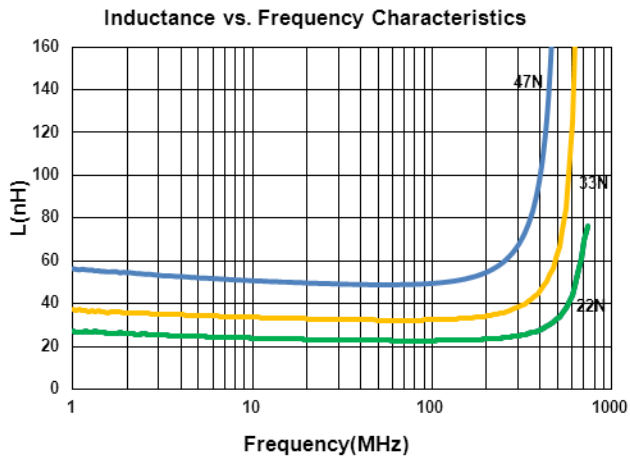

Packaging Specifications

Tape Dimensions

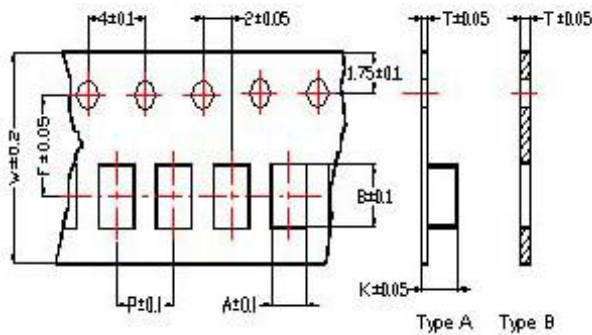

Tape Material

Carrier Tape: Polycarbonate (Tape A)
 Carrier Tape: Paper (Tape B)
 Cover Tape: Polystyrene

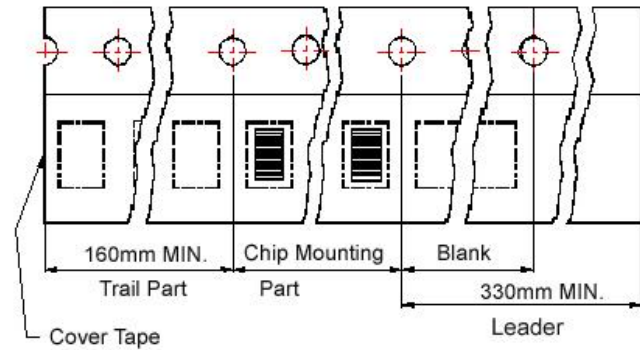

Reel Dimensions

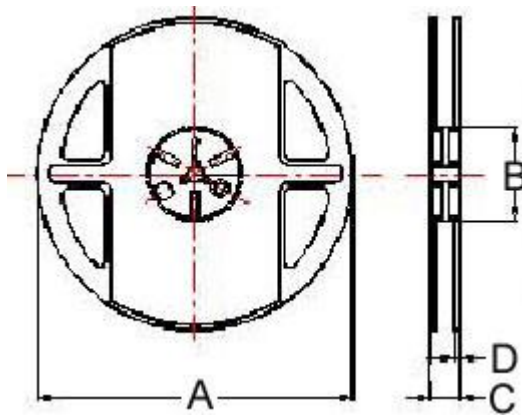

Dimensions in mm

TYPE	Tape Dimensions								Reel Dimensions				Quantity PCS / REEL
	A	B	T	W	P	F	K	Tape Type	A	B	C	D	
2012C5	1.45	2.25	0.22	8.0	4.0	3.5	1.04	A	178	60	12	1.5	3000

For More Information:

Americas - prodinfo_power_americas@yageo.com | Europe - prodinfo_power_emea@yageo.com | Asia - prodinfo_power_asia@yageo.com

Performance warranty of products offered on this data sheet is limited to the parameters specified. Data is subject to change without notice. Other brand and product names mentioned herein may be trademarks or registered trademarks of their respective owners. © Copyright, 2022. Pulse Electronics, Inc. All rights reserved.

Looking for pricing, stock, or lifecycle information?

Click below to explore more details on WIN SOURCE:

 [View BKPA002012104R7M00 on WIN SOURCE](#)

 [Chilisin Information](#)

Optimize Your Supply Chain with WIN SOURCE Solutions

-  Global Sourcing Solution
-  Obsolete Management
-  Cost Control Management
-  Shortage Management
-  Alternative Solution
-  Excess Inventory Management