



THE DATASHEET OF SGP41-D-R4



Datasheet SGP41

Air Quality Sensor for VOC and NO_x Measurements

- MO_x based gas sensor for air quality applications
- Outstanding long-term stability and lifetime
- I²C interface with digital output signals
- Very small 6-pin DFN package: 2.44 x 2.44 x 0.85 mm³
- Low power consumption: 3.0 mA at 3.3 V
- Tape and reel packaged, reflow solderable

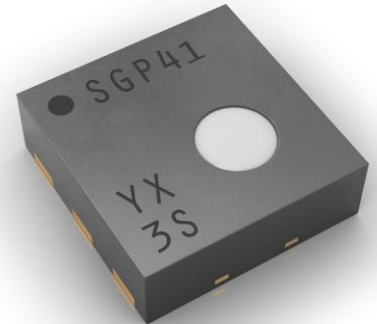

Product Summary

The SGP41 is a digital gas sensor designed for easy integration into air purifiers or demand-controlled ventilation systems. Sensirion's CMOSens® technology offers a complete, easy-to-use sensor system on a single chip featuring a digital I²C interface and temperature-controlled micro hotplates, providing one VOC and one NO_x based indoor air quality signal. Both sensing element and Gas Index Algorithm feature an unmatched robustness against contaminating gases present in real-

world applications enabling a unique long-term stability as well as low drift. The very small 2.44 x 2.44 x 0.85 mm³ DFN package enables applications in limited spaces. Sensirion's state-of-the-art production process guarantees high reproducibility and reliability. Tape and reel packaging together with suitability for standard SMD assembly processes make the SGP41 predestined for high-volume applications.

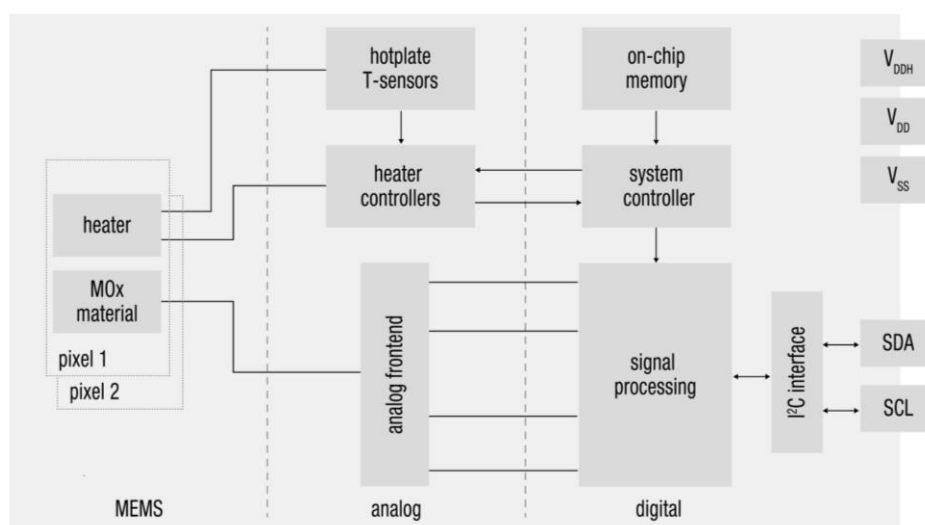

Figure 1 Functional block diagram of the SGP41.

Table of Contents

1 Sensor Performance	3
2 Specifications	5
2.1 Electrical Specifications	5
2.2 Timing Specifications	5
2.3 Recommended Operating and Storage Conditions	6
2.4 Absolute Minimum and Maximum Ratings	7
2.5 Interface Specifications	7
2.6 Environmental Stability	8
2.7 Material Contents	8
3 Sensor Output Signal Description	9
3.1 Conditioning	9
3.2 Raw Signal Measurement	9
3.3 VOC and NO _x Index Measurement	10
3.4 Built-in Self-Test	11
3.5 Reading out The Sensor Serial Number	11
3.6 Sensor Start-up Behavior	11
4 Digital Interface Description	12
4.1 General Considerations	12
4.2 I ² C Address	12
4.3 I ² C Voltage Levels	12
4.4 I ² C Protocol Speed	12
4.5 I ² C Sequences	12
4.6 Checksum Calculation	13
4.7 I ² C Commands	13
5 Mechanical Specifications	18
5.1 Traceability	18
5.2 Package Outline	18
5.3 Land Pattern	19
5.4 Soldering Instructions	19
6 Ordering Information	20
6.1 Packaging Information	20

1 Sensor Performance

Table 1 lists specifications characterizing the gas sensing performance. The SGP41 chip provides two digital raw signals which are sensitive to most VOCs typically present in indoor environments and oxidizing gases such as NO_x or O₃, respectively. The raw signals are proportional to the logarithm of the resistance of the sensing material. For the specifications given below, ethanol in clean air has been used as proxy gas for typical VOC based indoor air events and NO₂ in clean air has been used as proxy gas for typical oxidizing gas based indoor air events.

Parameter	Conditions	Values ¹			Units
		Min.	Typ.	Max.	
Output signal range ²	VOC Index, processed value from SRAW_VOC	1	–	500	VOC Index points
	NO _x Index, processed value from SRAW_NOX	1	–	500	NO _x Index points
	SRAW_VOC, digital raw value from VOC pixel	0	–	65'535	ticks ³
	SRAW_NOX, digital raw value from NO _x pixel	0	–	65'535	ticks
Measurement range	Ethanol in clean air	0	–	1'000'000	ppb
	NO ₂ in clean air	0	–	10'000	ppb
Specified range	Ethanol in clean air	500	–	10'000	ppb
	NO ₂ in clean air	50	–	650	ppb
Device-to-device variation ⁴	VOC Index	–	<±15 <±15	–	VOC Index points or % m.v. (the larger)
	NO _x Index	–	<±50 <±50	–	NO _x Index points or % m.v. (the larger)
Repeatability ⁴	VOC Index	–	<±5 <±5	–	VOC Index points or % m.v. (the larger)
	NO _x Index	–	<±5 <±5	–	NO _x Index points or % m.v. (the larger)
Limit of detection ^{5,6}	Ethanol in 500 ppb of ethanol ⁷ and 0 ppb of NO ₂ in else clean air	–	–	<50 or <10	ppb or % of concentration setpoint (the larger)
	NO ₂ in 500 ppb of ethanol ⁷ in else clean air	–	–	<20 or <10	
Response time τ ₆₃	SRAW_VOC, changing concentration from 5'000 to 10'000 ppb of ethanol at sampling interval of 1 s	–	<10	–	s
	SRAW_NOX, changing concentration from 150 to 300 ppb of NO ₂ at sampling interval of 1 s	–	<250	–	s

¹ 99 % of the sensors will be within the minimum–maximum tolerance. Typical tolerance refers to the mean of the distribution for ≥100 sensors.

² Humidity compensated when actual humidity value is provided as input to the sensor (see section 3.2 Raw Signal Measurement).

³ Signal in ticks is proportional to the logarithm of the resistance of the sensing layer.

⁴ Evaluated using the calibration and test sequence according to the application note SGP41 – Testing Guide.

⁵ Limit of detection is defined as the minimum change of concentration required to obtain a raw signal change 3 times higher than the noise at the given concentration setpoint.

⁶ Parameter tested over simulated lifetime of 10 years in an indoor environment. Test conditions: continuous operation in 250 ppm of Decamethylcyclpentasiloxane (D5) for 200 h.

⁷ A concentration of 500 ppb of ethanol corresponds to the equivalent of a typical VOC background present in an application environment, e.g., a typical OEM device.

Parameter	Conditions	Values			Units	
		Min.	Typ.	Max.		
Switch-on behavior	Time until reliably detecting VOC or NO _x events ⁸	–	<60	–	s	
	Time until specifications in this table are met	SRAW_VOC	–	<1	–	h
		VOC Index	–	<1.5	–	h
		SRAW_NOX	–	<7	–	d
		NO _x Index	–	<6	–	h
Sensitivity ⁶	SRAW_VOC, doubling VOC concentration in else clean air	Ethanol in specified range	–	-870	–	ticks
		5'000 to 10'000 ppb of ethanol	-710	-870	-1'030	ticks
	SRAW_NOX, doubling NO ₂ concentration in else clean air	NO ₂ in specified range	–	+1'480	–	ticks
		150 to 300 ppb of NO ₂	+950	+1'480	+2'010	ticks
Sampling interval	–	0.5	1	10	s	

Table 1 Gas sensing specifications at 25 °C and 50 % RH in zero air (considered as clean air for indoor air quality applications) and a power supply of VDD of 3.3 V.

Figure 2 and **Figure 3** display the typical response of the VOC and NO_x raw signals, respectively, of SGP41 to ethanol, NO₂, and O₃ as a function of their concentrations in otherwise clean air and a background consisting of 500 ppb of H₂ + 500 ppb of ethanol.

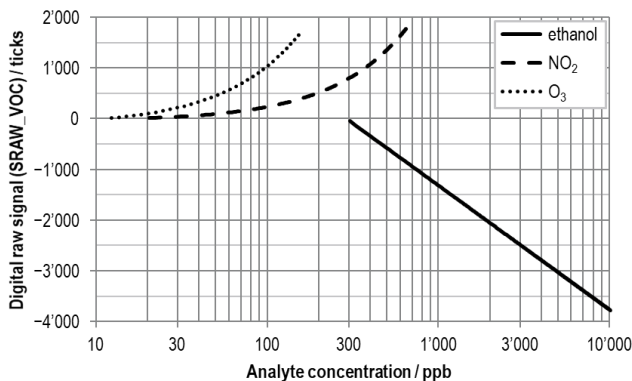

Figure 2 Typical sensor response by the VOC signal to ethanol, NO₂, and O₃ normalized to 500 ppb of H₂ + 500 ppb of ethanol. Data were recorded at 25 °C and 50 % RH and a power supply of VDD of 3.3 V.

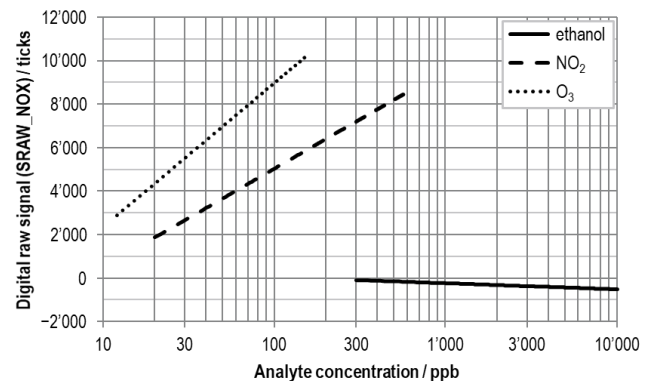

Figure 3 Typical sensor response by the NO_x signal to ethanol, NO₂, and O₃ normalized to 500 ppb of H₂ + 500 ppb of ethanol. Data were recorded at 25 °C and 50 % RH and a power supply of VDD of 3.3 V.

⁸ Signal change during 60-s event of 5'000 to 10'000 ppb of ethanol or of 100 to 300 ppb of NO₂ is three times larger than signal drift of SRAW_VOC or SRAW_NOX, respectively, without this event during the same duration.

2 Specifications

2.1 Electrical Specifications

Table 2 lists electrical specifications of the SGP41. Default conditions of 25 °C and 3.3 V supply voltage apply to values in the table below, unless otherwise stated. The SGP41 supports both I²C “standard-mode” and “fast-mode” (see *NXP I²C-bus specification and user manual*).

Parameter	Symbol	Values			Unit	Comments
		Min.	Typ.	Max.		
Supply voltage, hotplate supply voltage ⁹	VDD, VDDH	1.7	3.3	3.6	V	Minimal voltage must be guaranteed also for the maximum supply current specified in this table. VDD and VDDH must be connected to the same power supply, see Figure 6 .
Idle current	I _{DD}	–	34	105	μA	The idle mode is activated after power-up, after calling the <i>sgp4x_turn_heater_off</i> command, or after a soft reset.
Supply current during conditioning mode ¹⁰		–	6.5	7.2	mA	Average current consumption while the sensor is continuously operated at VDD, VDDH = 1.8 V.
		–	4.2	4.6	mA	Average current consumption while the sensor is continuously operated at VDD, VDDH = 3.3 V.
Supply current during VOC+NO _x measurement mode ¹⁰		–	4.3	4.8	mA	Average current consumption while the sensor is continuously operated at VDD, VDDH = 1.8 V.
	–	3.0	3.4	mA	Average current consumption while the sensor is continuously operated at VDD, VDDH = 3.3 V.	
Communication	–	Digital 2-wire interface, I ² C				

Table 2 Electrical specifications.

2.2 Timing Specifications

Timings in **Table 3** refer to the power up and reset of the ASIC part and do not reflect the usefulness of the readings.

Parameter	Symbol	Condition	Min.	Typ.	Max.	Unit
Power-up time	t _{PU}	After hard reset, VDD ≥ VPOR	–	0.4	0.6	ms
Soft reset time	t _{SR}	After soft reset	–	0.4	0.6	ms
SCL clock frequency	f _{SCL}	–	–	–	400	kHz

Table 3 System timing specifications.

⁹ Any supply voltage as defined by the min./max. range may be used for continuous operation of the sensor. The typical value specifies the supply voltage at which outgoing quality control is performed.

¹⁰ Sending the *sgp41_execute_conditioning* and *sgp41_measure_raw_signals* command enables continuous operation of the sensor. A 20 % higher current is drawn during 5 ms on VDDH after sending either of the two commands.

2.3 Recommended Operating and Storage Conditions

Gas Sensing Specifications as detailed in **Table 1** are guaranteed only when the sensor is stored and operated under the recommended conditions as specified in **Table 4** and displayed in **Figure 4** and **Figure 5**. Prolonged exposure to conditions outside these conditions may reduce sensor performance. The sensor must not be exposed towards condensing conditions (*i.e.*, >90 % relative humidity) at any time.

Condition	Parameter	Min.	Max.	Unit
Operating conditions	Relative humidity	0	90	% RH
	Temperature	-10	50	°C
Operating conditions of humidity compensation	Humidity	1.5 (-13)	30 (+31) 90 (the smaller)	g m ⁻³ (°C dew point) or % RH
	Temperature	-10	50	°C
Storage conditions	Relative humidity	0	80	% RH
	Temperature	5	30	°C

Table 4 Recommended humidity and temperature conditions for storing and operating the SGP41. Dew point refers to maximum humidity allowed at minimum and maximum temperature, respectively.

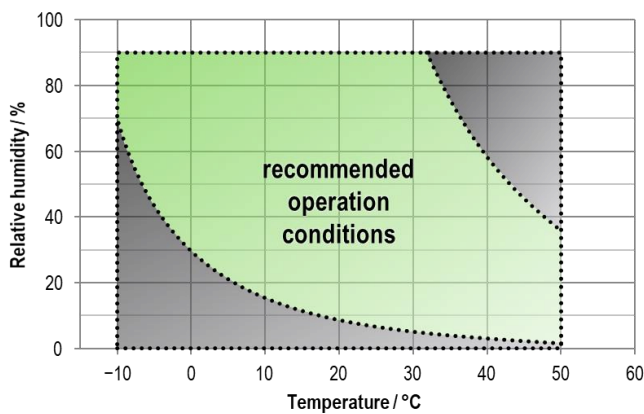

Figure 4 Recommended relative humidity and temperature for operating the SGP41. Green area marks conditions for which humidity compensation has been optimized. Additionally, gray areas mark operating conditions without using the humidity compensation feature.

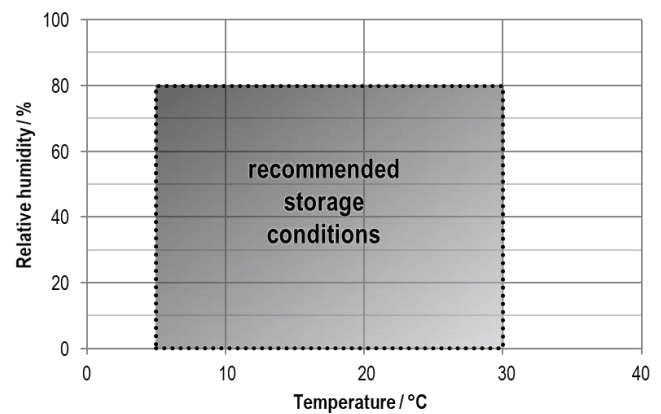

Figure 5 Recommended relative humidity and temperature for storing the SGP41.

To ensure an optimal performance of the SGP41, *Handling and Assembly Instructions for SGPxx Gas Sensors* as well as the *Design-in Guide for Integrating SGP4x Gas Sensors* need to be followed.

2.4 Absolute Minimum and Maximum Ratings

Stress levels beyond those listed in **Table 5** may cause permanent damage to the device. Exposure to minimum/maximum rating conditions for extended periods may affect sensor performance and reliability of the device.

Parameter	Rating
Supply voltage VDD	-0.3 to +3.6 V
Supply voltage VDDH	-0.3 to +3.6 V
Short-term storage temperature range ¹¹	-40 to +70 °C
Operating temperature range	-20 to +55 °C
Short-term storage humidity range ¹²	0 to 80 % (non-condensing)
Operating humidity range	0 to 90 % (non-condensing)
ESD HBM	2 kV
ESD CDM	500 V
Latch up, JESD78 Class II, 125 °C	100 mA

Table 5 Absolute minimum and maximum ratings.

2.5 Interface Specifications

The SGP41 comes in a 6-pin DFN package, see **Table 6**. **Figure 6** shows a typical application circuit. The VDD pin must be decoupled with an RC element. The required decoupling for VDDH depends on the power supply network connected to the sensor, a capacitor of 1 µF is recommended. VDD and VDDH must be connected to one single supply VDD. The external pull-up resistors (e.g., $R_p = 10\text{ k}\Omega$) are required to pull the SDA and SCL signal lines high. For dimensioning resistor sizes please take bus capacity and communication frequency into account (see section 7.1 of *NXP I²C-bus specification and user manual* for more details). It should be noted that pull-up resistors may be included in I/O circuits of microcontrollers. The die pad or center pad is electrically connected to GND. Hence, electrical considerations do not impose constraints on the wiring of the die pad. However, for mechanical stability it is recommended to solder the die pad to the PCB.

Pin	Name	Comments
1	VDD	Supply voltage
2	VSS	Ground
3	SDA	Serial data, bidirectional
4	n/a	Connect to ground (no electrical function)
5	VDDH	Supply voltage, hotplate
6	SCL	Serial clock, bidirectional

Table 6 Pin assignment (transparent top view). Dashed lines are only visible from the bottom.

¹¹ Short-term storage refers to temporary conditions during, e.g., transport.

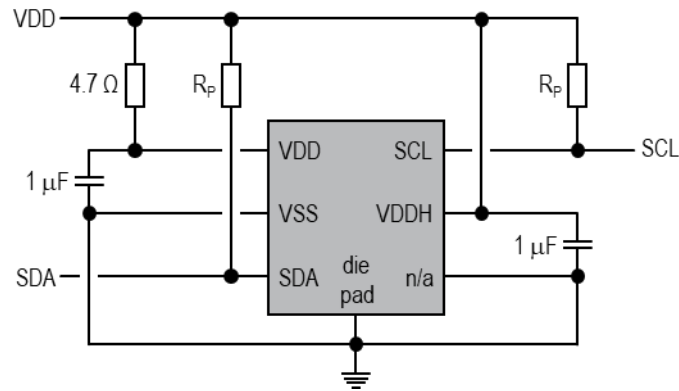

Figure 6 Typical application circuit.

2.6 Environmental Stability

The SGP41 has been qualified based on the JEDEC JESD47 qualification test method. The Moisture Sensitivity Level classification of the SGP41 is MSL1, according to IPC/JEDEC J-STD-020. At the same time, it is recommended to further process the sensors within 1 year after date of delivery. The SGP41 should not be exposed to bright illumination by either sunlight or artificial light sources during operation.

2.7 Material Contents

The device is fully RoHS, REACH, Halogen-free, and WEEE compliant, e.g., free of Pb, Cd, and Hg.

3 Sensor Output Signal Description

3.1 Conditioning

After each restart of the sensor or when the hotplates have been switched off, the *sgp41_execute_conditioning* command must be called from idle mode before the master calls the first *sgp41_measure_raw_signals* command (**Figure 7**). The conditioning heats the hotplate of the NO_x pixel to a different temperature compared to the measurement mode enabling a faster switch-on (as specified in **Table 1**) thereafter. It is recommended to execute the conditioning for 10 s, but 10 s must not be exceeded to avoid damage to the sensing material. Thereafter, the VOC+NO_x measurement mode can be entered by following the instructions given in 3.2 Raw Signal Measurement. The conditioning command requires to send default input parameters (2 words + respective CRC bytes).

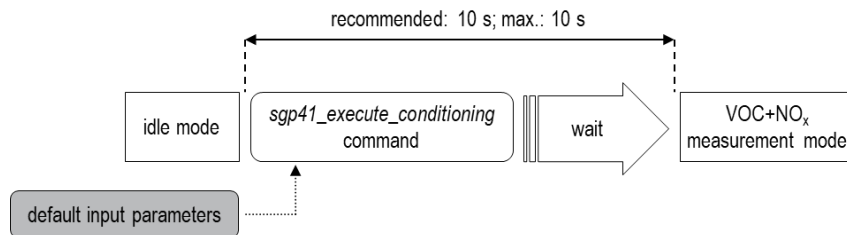

Figure 7 Standard process flow for executing the conditioning of SGP41.

Optionally, the master may already read out the raw signal of the VOC pixel (SRAW_VOC) during conditioning (**Figure 8**) since the hotplate of the VOC pixel will already be set to the temperature used in the VOC+NO_x measurement mode. After calling the *sgp41_execute_conditioning* command and after a subsequent minimum waiting time of 50 ms, SRAW_VOC is returned as one 16-bit word followed by a CRC byte. The *sgp41_execute_conditioning* command can be called consecutively multiple times during the conditioning period.

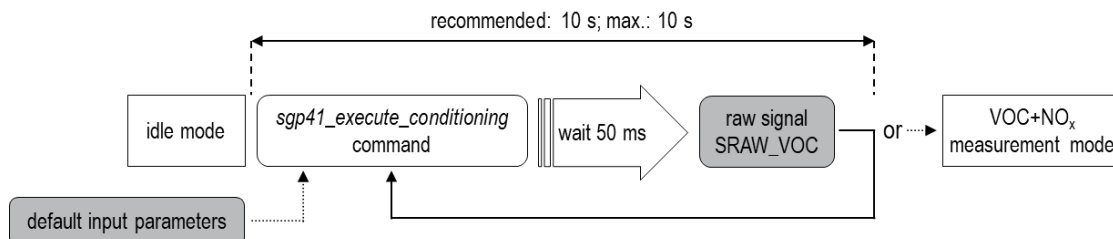

Figure 8 Optional process flow for executing the conditioning of SGP41 and reading out the VOC raw signal.

3.2 Raw Signal Measurement

Calling the *sgp41_measure_raw_signals* command launches/continues the VOC+NO_x measurement mode. The first call of this command should be performed after the conditioning (see 3.1 Conditioning). This command starts one measurement of the raw signals of the VOC and the NO_x pixel (SRAW_VOC, SRAW_NOX) which are returned after 50 ms. The two raw signal values in ticks are provided as two 16-bit words each followed by one CRC byte (**Figure 9**). The raw signals in ticks are proportional each to the logarithm of the corresponding sensor resistance. These two signals are used as input for Sensirion's Gas Index Algorithm to provide processed VOC and NO_x Indices (see section 3.3 VOC and NO_x Index Measurement). In case the Gas Index Algorithm is not used, discard the first measured value of each signal. Typically, a measurement is performed every second by calling the *sgp41_measure_raw_signals* command again every second without turning the heater off. To exit the VOC+NO_x measurement mode, the master calls the *sgp4x_turn_heater_off* command which switches off the hotplates and puts the sensor in idle mode. In order to avoid prolonged run-in of the NO_x signal, it is recommended to keep the measurement running whenever possible.

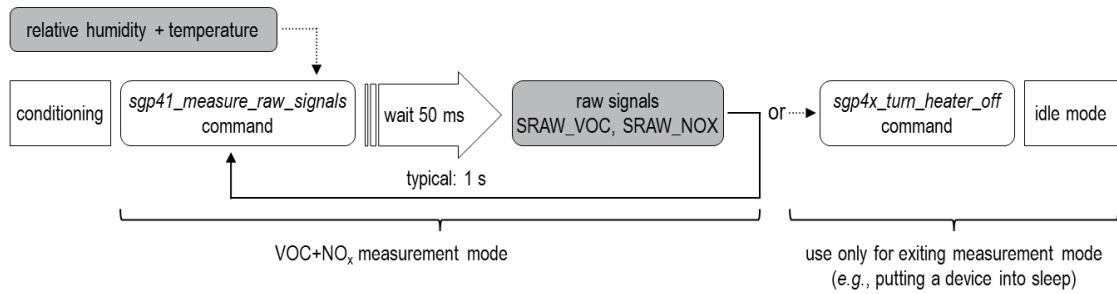

Figure 9 Process flow for performing a raw signal measurement with the SGP41. For enabling on-chip humidity compensation, current relative humidity and temperature values have to be supplied as part of the measurement command.

The SGP41 features an automatic on-chip humidity compensation of both raw signals. The feature remains disabled as long as default values for both humidity and temperature are sent together with the `sgp41_measure_raw_signals` command. For enabling the compensation, the measurement command includes two words (+ respective CRC bytes) where the first word represents the relative humidity and the second one represents the temperature.

3.3 VOC and NO_x Index Measurement

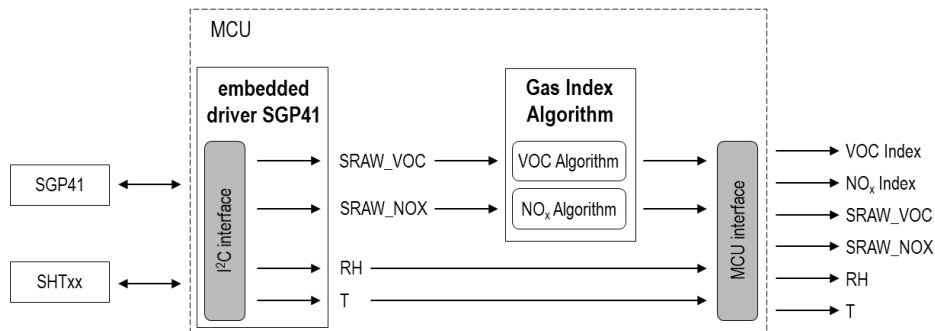

Figure 10 Schematic of the driver and Gas Index Algorithm implementation on a microcontroller.

For best performance in indoor-air-quality use cases, Sensirion recommends processing the (humidity-compensated) raw signals `SRAW_VOC` and `SRAW_NOX` through Sensirion’s powerful Gas Index Algorithm. This algorithm (**Figure 10**) automatically adapts its outputs to any indoor environment and maps all VOC and NO_x events to a VOC (**Figure 11**) and NO_x Index (**Figure 12**) scale, respectively, ranging from 1 to 500 index points. In case of the VOC Index, a value of 100 refers to the average indoor gas composition over the past 24 h. While values between 100 and 500 indicate a deterioration, values between 1 and 100 inform about improvement of the VOC based air quality. In case of the NO_x Index, the average condition is mapped to a value of 1 and therefore, the NO_x Index displays values between 2 and 500 when NO_x events are present. The Gas Index Algorithm is available on github (see SGP41 product page on Sensirion’s webpage). SGP41 raw signals need to be provided to the Gas Index Algorithm at a sampling rate of 1 s.

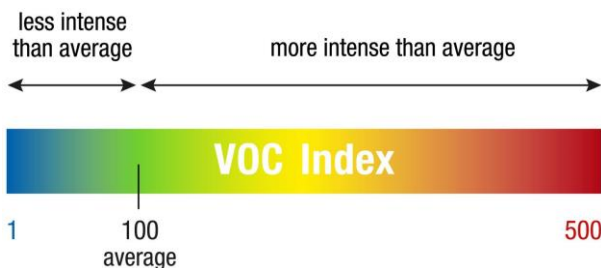

Figure 11 Explanation of the VOC Index scale.

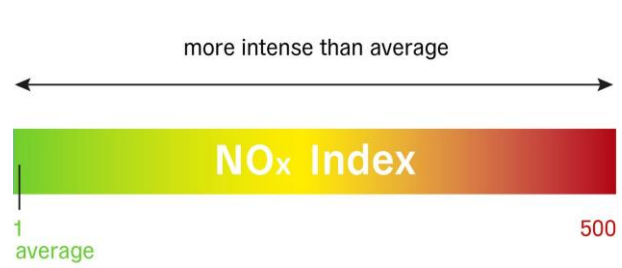

Figure 12 Explanation of the NO_x Index scale.

3.4 Built-in Self-Test

With the `sgp41_execute_self_test` command, users can perform an on-chip self-test for, e.g., in-line or end-of-line production testing. If this command is called when the sensor is in idle mode, the sensor returns to idle mode after the test (**Figure 13**). In case this command is called during VOC+NO_x measurement mode (i.e., after calling the `sgp41_measure_raw_signals` command), the hotplate remains switched on thereafter. It is not recommended to call this command during conditioning mode (i.e., after calling the `sgp41_execute_conditioning` command). After 320 ms, the master can read a fixed data pattern (1 word + CRC byte) to check if the test was successful or not.

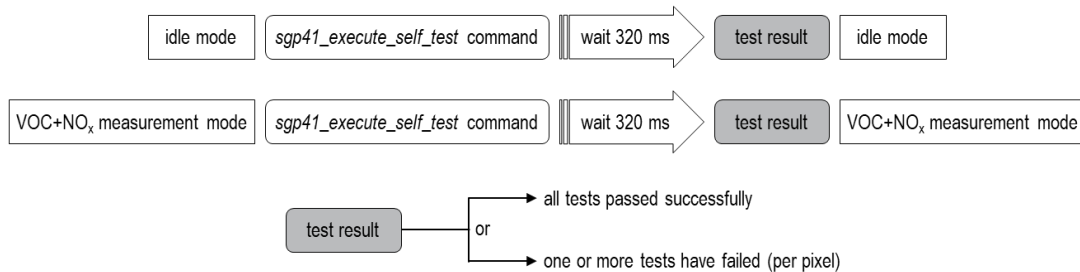

Figure 13 Process flow for performing the built-in self-test.

3.5 Reading out The Sensor Serial Number

Every SGP41 sensor carries a unique serial number for identification purposes which is hard coded during sensor production. This number can be read out by using the `sgp4x_get_serial_number` command at any time in idle mode (**Figure 14**). After 1 ms, the chip responds with 3 words (each word followed by one CRC byte) which together constitute the serial number.

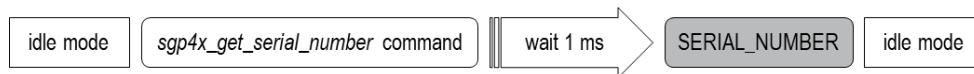

Figure 14 Process flow for reading out the serial number of the SGP41 sensor.

3.6 Sensor Start-up Behavior

The sensor starts powering-up after reaching the power-up threshold voltage of 1.7 V and enters idle mode after max. 0.6 ms. In this state, the sensor is ready to receive commands from the master.

structured in data words, where one word consists of two bytes of data (most significant bit first) followed by a one-byte CRC checksum. Each byte must be acknowledged by the master with an ACK condition for the sensor to continue sending data. If the sensor does not receive an ACK from the master after any byte of data, it will not continue sending data.

After receiving the checksum for the last word of data, a NACK and STOP condition have to be sent (see **Figure 15**). The I²C master can abort the read transfer with a NACK followed by a STOP condition after any data byte if it is not interested in subsequent data, e.g., the CRC byte or following data bytes, in order to save time. Note that the data cannot be read more than once, and access to data beyond the specified amount will return a pattern of high bits.

4.6 Checksum Calculation

The 8-bit CRC checksum transmitted after each data word is generated by the CRC algorithm according to the properties as stated in **Table 7**. The CRC covers the contents of the two previously transmitted data bytes.

Property	Value	Example code
Name	CRC-8	<pre>uint8_t CalcCrc(uint8_t data[2]) { uint8_t crc = 0xFF; for(int i = 0; i < 2; i++) { crc ^= data[i]; for(uint8_t bit = 8; bit > 0; --bit) { if(crc & 0x80) { crc = (crc << 1) ^ 0x31u; } else { crc = (crc << 1); } } } return crc; }</pre>
Width	8 bit	
Protected Data	read and/or write data	
Polynomial	0x31 (x ⁸ + x ⁵ + x ⁴ + 1)	
Initialization	0xFF	
Reflect input	False	
Reflect output	False	
Final XOR	0x00	
Examples	CRC (0xBE 0xEF) = 0x92	

Table 7 Checksums are used for the 2-byte data packets only. The command codes themselves already contain a 3-bit CRC and therefore, a checksum must not be appended.

4.7 I²C Commands

The available measurement commands of the SGP41 are listed in **Table 8**.

Command	Command hex. code	Parameter length including CRC [bytes]	Response length including CRC [bytes]	Measurement duration [ms]	
				Typ.	Max.
<i>sgp41_execute_conditioning</i>	0x26 0x12	6	3	45	50
<i>sgp41_measure_raw_signals</i>	0x26 0x19	6	6	45	50
<i>sgp41_execute_self_test</i>	0x28 0x0E	–	3	300	320
<i>sgp4x_turn_heater_off</i>	0x36 0x15	–	–	0.1	1
<i>sgp4x_get_serial_number</i>	0x36 0x82	–	9	0.1	1

Table 8 I²C commands available for SGP41.

Conditioning

Command	Command hex. code	Description
<i>sgp41_execute_conditioning</i>	0x26 0x12 0x80 0x00 0xA2 0x66 0x66 0x93	This command starts the conditioning, <i>i.e.</i> , the VOC pixel will be operated at the same temperature as it is by calling the <i>sgp41_measure_raw_signals</i> command while the NO _x pixel will be operated at a different temperature for conditioning. This command returns only the measured raw signal of the VOC pixel SRAW_VOC as 2 bytes (+ 1 CRC byte).

Table 9 Description of the I²C conditioning command.

Byte number	Description	Value
0, 1	two bytes	u16 unsigned integer directly provides the raw signal SRAW_VOC in ticks which is proportional to the logarithm of the resistance of the sensing element.
2	CRC byte for bytes 0, 1	–

Table 10 Returned values by the I²C conditioning command.

Measure Raw Signals

Command	Subcommand	Command hex. code	Description
<i>sgp41_measure_raw_signals</i>	Without humidity compensation	0x26 0x19 0x80 0x00 0xA2 0x66 0x66 0x93	This command starts/continues the VOC+NO _x measurement mode, leaves humidity compensation disabled by sending the default values (see Table 12) and returns the measured raw signals SRAW_VOC and SRAW_NOX as 2x2 bytes (+ 1 CRC byte).
	With humidity compensation	0x26 0x19 0xXX 0xXX 0xXX 0xYY 0xYY 0xYY	In order to enable the humidity compensation, the master has to specify the relative humidity 0xXX 0xXX 0xXX and temperature 0xYY 0xYY 0xYY input (incl. corresponding CRC bytes) in the format as given in Table 12 .

Table 11 Description of the I²C measurement command.

	Relative Humidity		Temperature	
	Value / %	Hex. code	Value / °C	Hex. code
Conversion into ticks	$RH/ticks = RH/\% \times \frac{65'535}{100}$		$T/ticks = (T/^\circ C + 45) \times \frac{65'535}{175}$	
Default	50	0x80 0x00 + CRC 0xA2	25	0x66 0x66 + CRC 0x93
Minimum	0	0x00 0x00 + CRC 0x81	-45	0x00 0x00 + CRC 0x81
Maximum	100	0xFF 0xFF + CRC 0xAC	130	0xFF 0xFF + CRC 0xAC

Table 12 Conversion of relative humidity in % and temperature in °C into ticks as the input parameters of the measurement command. Note: minimum and maximum values do not reflect the range of conditions for which the humidity compensation feature has been optimized (see **Table 4**).

Byte number	Description	Value
0, 1	two bytes	u16 unsigned integer directly provides the raw signal SRAW_VOC in ticks which is proportional to the logarithm of the resistance of the sensing element.
2	CRC byte for bytes 0, 1	–
3, 4	two bytes	u16 unsigned integer directly provides the raw signal SRAW_NOX in ticks which is proportional to the logarithm of the resistance of the sensing element.
5	CRC byte for bytes 3, 4	–

Table 13 Returned values by the I²C measurement command.

Built-in Self-Test

Command	Command hex. code	Description
<i>sgp41_execute_self_test</i>	0x28 0x0E	This command triggers the built-in self-test checking for integrity of both hotplate and MOX material and returns the result of this test as 2 bytes (+ 1 CRC byte).

Table 14 Description of the I²C built-in self-test command.

Byte number	Description	Value										
0, 1	two bytes	<p>0xXX 0xYY: ignore most significant byte 0xXX. The four least significant bits of the least significant byte 0xYY provide information if the self-test has or has not passed for each individual pixel:</p> <table border="1"> <thead> <tr> <th>bit</th> <th>3</th> <th>2</th> <th>1</th> <th>0</th> </tr> </thead> <tbody> <tr> <td></td> <td>ignore</td> <td>ignore</td> <td>NO_x pixel</td> <td>VOC pixel</td> </tr> </tbody> </table> <p>Possible results for each bit: 0: all tests passed successfully 1: one or more tests have failed</p>	bit	3	2	1	0		ignore	ignore	NO _x pixel	VOC pixel
bit	3	2	1	0								
	ignore	ignore	NO _x pixel	VOC pixel								
2	CRC byte for bytes 0, 1	–										

Table 15 Returned values by the I²C built-in self-test command.

Turn Heater off and Return to Idle Mode

Command	Command hex. code	Description
<i>sgp4x_turn_heater_off</i>	0x36 0x15	This command turns the hotplate off and stops the measurement. Subsequently, the sensor enters the idle mode.

Table 16 Description of the I²C heater off command.

Read out The Sensor Serial Number

Command	Command hex. code	Description
<i>sgp4x_get_serial_number</i>	0x36 0x82	This command provides the decimal serial number of the SGP41 chip by returning 3x2 bytes (+ 1 CRC byte).

Table 17 Description of the I²C get serial number command.

Byte number	Description	Value
0, 1	two bytes	First (<i>i.e.</i> , most significant) and second byte of the serial number.
2	CRC byte for bytes 0, 1	–
3, 4	two bytes	Third and fourth byte of the serial number.
5	CRC byte for bytes 3, 4	–
6, 7	two bytes	Fifth and sixth (<i>i.e.</i> , least significant) byte of the serial number.
8	CRC byte for bytes 6, 7	–

Table 18 Returned values by the I²C get serial number command.

Soft Reset

Command	Command hex. code	Description
<i>soft_reset</i>	0x00 0x06	This command is a general call resetting all devices connected to the same I ² C bus. The first byte refers to the general call address and the second byte refers to the reset command. After calling this command, the SGP41 will restart entering the idle mode.

Table 19 Description of the I²C general soft reset command.

5 Mechanical Specifications

SGP41 sensors are provided in a DFN (dual flat no leads) package with an outline of $2.44 \times 2.44 \times 0.85 \text{ mm}^3$ and a terminal pitch of 0.8 mm. The sensor opening with a typical diameter of 0.8 mm is offset to the bottom right corner on the top side of the package. The sensor chip is assembled on a Ni/Pd/Au plated copper lead frame. Sensor chip and lead frame are over-molded by a black, epoxy-based mold compound. Please note that the side walls of the package are diced and therefore the lead frame sidewall surfaces are not plated.

5.1 Traceability

All SGP41 sensors are laser marked for easy identification and traceability (**Figure 16**). The marking on the sensor top side consists of a pin-1 indicator and three lines of text. The top line consists of the pin-1 indicator which is located in the top left corner and the product name. The two lines at the bottom consist of 2 alphanumeric digits each. That code can be decoded by Sensirion only and allows for tracking on batch level through production, calibration, and testing – and will be provided upon justified request.

If viewed from below pin 1 is indicated by triangular shaped cut in the otherwise rectangular die pad. The dimensions of the triangular cut are shown in **Figure 17**, right. The sensor opening on the top side is not recommended for optical alignment.



Figure 16 Top view of the SGP41 illustrating the laser marking.

5.2 Package Outline

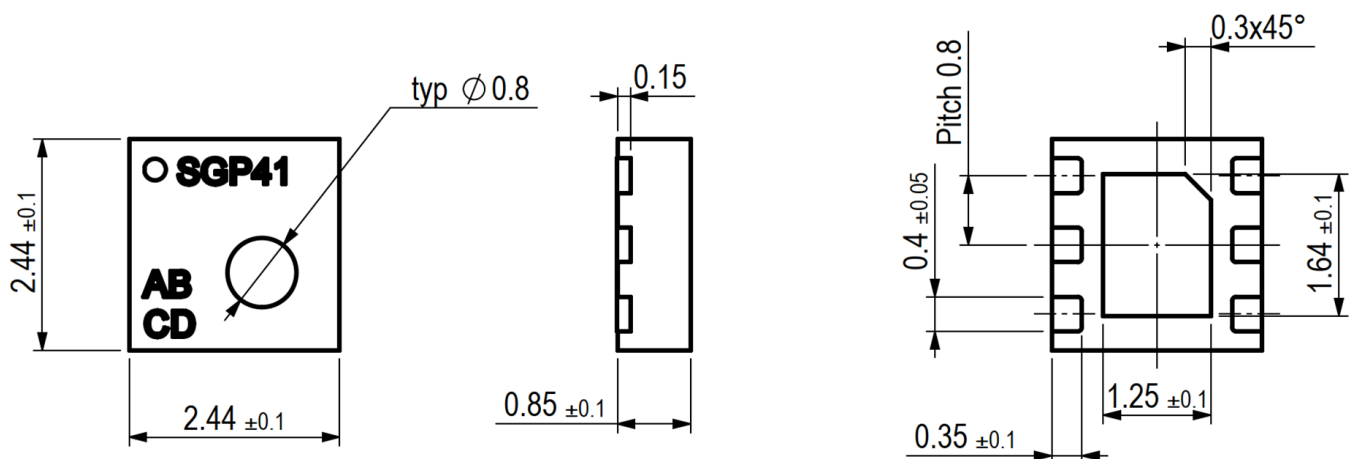

Figure 17 Package outline drawing of the SGP41. Dimensions are given in millimeters.

5.3 Land Pattern

Recommended land pattern of the SGP41 is shown in **Figure 18**. Pads on PCB are recommended to be non-solder mask defined (NSMD). Recommended solder paste stencil thickness is 125–150 μm .

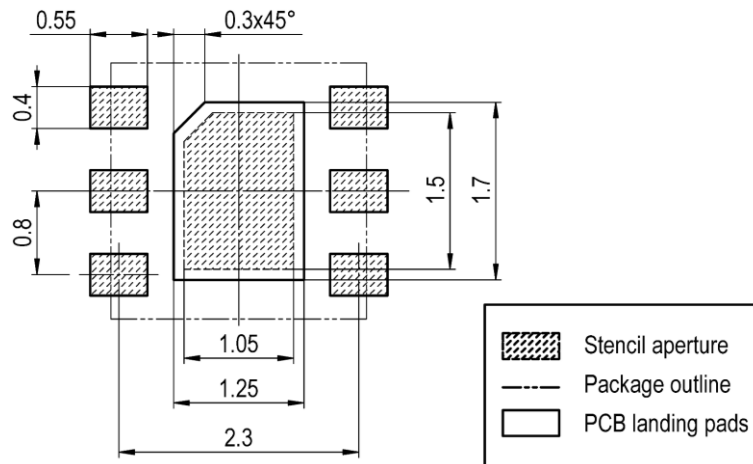

Figure 18 Recommended land pattern.

5.4 Soldering Instructions

Standard reflow soldering ovens and “no clean” type 3 solder paste (as specified in IPC J-STD-005A) should be used for soldering the SGP41. The sensors are designed to withstand a soldering profile according to IPC/JEDEC J-STD-020. Peak temperatures of $T_P = 245\text{ }^\circ\text{C}$ during up to $t_p = 30\text{ s}$ for Pb-free assembly in IR/Convection reflow ovens (see **Figure 19**) are recommended. In addition, we also recommend a maximum ramp-down rate of $<4\text{ }^\circ\text{C s}^{-1}$. Vapor phase or manual soldering should not be used in order to avoid damaging of the sensor. In case the PCB hosting the SGP41 chip passes through multiple solder cycles, it is recommended to assemble the SGP41 during the last solder cycle. Board wash and ultrasonic cleaning should be avoided. For general information (such as conformal coating), please also refer to the *Handling and Assembly Instructions for SGPxx Gas Sensors*.

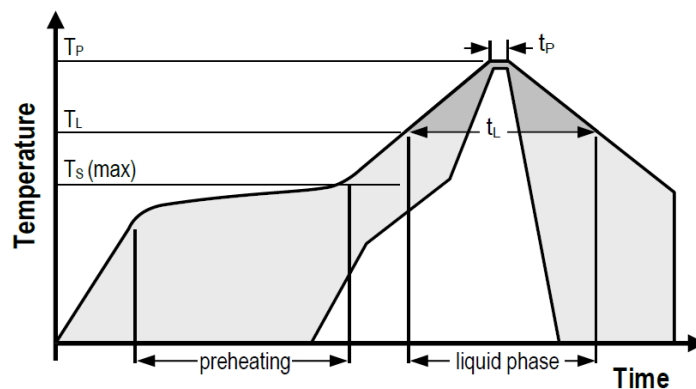

Figure 19 Soldering profile according to JEDEC standard. Recommended conditions are $T_P = 245\text{ }^\circ\text{C}$ and $t_p \leq 30\text{ s}$ for Pb-free assembly, $T_L < 220\text{ }^\circ\text{C}$ and $t_L < 150\text{ s}$. Ramp-up rate $<3\text{ }^\circ\text{C s}^{-1}$ and ramp-down rate $<4\text{ }^\circ\text{C s}^{-1}$.

6 Ordering Information

Use the part names and product numbers shown in the following table when ordering the SGP41 gas sensor and accessories. For the latest product information and local distributors, visit www.sensirion.com.

Part Name	Description	Ordering size	Product Number
SGP41-D-R4	SGP41 sensor components as tape on reel	2'500 pcs	3.000.060
SEK-SVM4x Evaluation Kit	1 SVM41 PCB equipped with SGP41, an SHT40, and an MCU; 1 USB cable; 1 jumper wire cable; direct humidity compensated VOC and NO _x Index output via UART or I ² C interface www.sensirion.com/my-sgp-ek	1 pc	3.000.630

Table 20 SGP41 ordering options.

6.1 Packaging Information

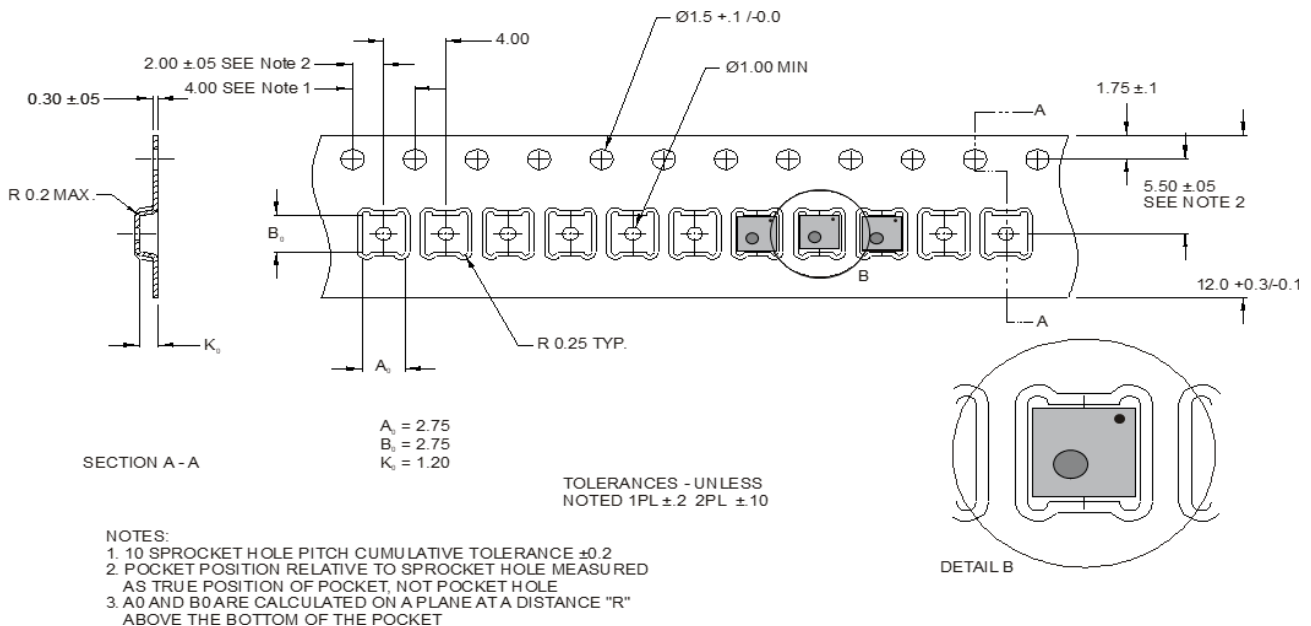

Figure 20 Technical drawing of the packaging tape with sensor orientation in tape. Header tape is to the right and trailer tape to the left on this drawing. Dimensions are given in millimeters.

Important Notices

Warning, Personal Injury

Do not use this product as safety or emergency stop devices or in any other application where failure of the product could result in personal injury. Do not use this product for applications other than its intended and authorized use. Before installing, handling, using or servicing this product, please consult the data sheet and application notes. Failure to comply with these instructions could result in death or serious injury.

If the Buyer shall purchase or use SENSIRION products for any unintended or unauthorized application, Buyer shall defend, indemnify and hold harmless SENSIRION and its officers, employees, subsidiaries, affiliates and distributors against all claims, costs, damages and expenses, and reasonable attorney fees arising out of, directly or indirectly, any claim of personal injury or death associated with such unintended or unauthorized use, even if SENSIRION shall be allegedly negligent with respect to the design or the manufacture of the product.

ESD Precautions

The inherent design of this component causes it to be sensitive to electrostatic discharge (ESD). To prevent ESD-induced damage and/or degradation, take customary and statutory ESD precautions when handling this product. See application note "ESD, Latchup and EMC" for more information.

Warranty

SENSIRION warrants solely to the original purchaser of this product for a period of 12 months (one year) from the date of delivery that this product shall be of the quality, material and workmanship defined in SENSIRION's published specifications of the product. Within such period, if proven to be defective, SENSIRION shall repair and/or replace this product, in SENSIRION's discretion, free of charge to the Buyer, provided that:

- notice in writing describing the defects shall be given to SENSIRION within fourteen (14) days after their appearance;
- such defects shall be found, to SENSIRION's reasonable satisfaction, to have arisen from SENSIRION's faulty design, material, or workmanship;
- the defective product shall be returned to SENSIRION's factory at the Buyer's expense; and
- the warranty period for any repaired or replaced product shall be limited to the unexpired portion of the original period.

This warranty does not apply to any equipment which has not been installed and used within the specifications recommended by SENSIRION for the intended and proper use of the equipment. EXCEPT FOR THE WARRANTIES EXPRESSLY SET FORTH HEREIN, SENSIRION MAKES NO WARRANTIES, EITHER EXPRESS OR IMPLIED, WITH RESPECT TO THE PRODUCT. ANY AND ALL WARRANTIES, INCLUDING WITHOUT LIMITATION, WARRANTIES OF MERCHANTABILITY OR FITNESS FOR A PARTICULAR PURPOSE, ARE EXPRESSLY EXCLUDED AND DECLINED.

SENSIRION is only liable for defects of this product arising under the conditions of operation provided for in the data sheet and proper use of the goods. SENSIRION explicitly disclaims all warranties, express or implied, for any period during which the goods are operated or stored not in accordance with the technical specifications.

SENSIRION does not assume any liability arising out of any application or use of any product or circuit and specifically disclaims any and all liability, including without limitation consequential or incidental damages. All operating parameters, including without limitation recommended parameters, must be validated for each customer's applications by customer's technical experts. Recommended parameters can and do vary in different applications.

SENSIRION reserves the right, without further notice, (i) to change the product specifications and/or the information in this document and (ii) to improve reliability, functions and design of this product.

Copyright© 2021, by SENSIRION.

CMOSens® is a trademark of Sensirion

All rights reserved

Revision History

Date	Version	Page(s)	Changes
December 2021	1.0	All	Initial release

Headquarters and Subsidiaries

Sensirion AG

Laubisruetistr. 50
CH-8712 Staefa ZH
Switzerland

phone: +41 44 306 40 00
fax: +41 44 306 40 30
info@sensirion.com
www.sensirion.com

Sensirion Taiwan Co. Ltd

phone: +886 3 5506701
info@sensirion.com
www.sensirion.com

Sensirion Inc., USA

phone: +1 312 690 5858
info-us@sensirion.com
www.sensirion.com

Sensirion Japan Co. Ltd.

phone: +81 3 3444 4940
info-jp@sensirion.com
www.sensirion.com/jp

Sensirion Korea Co. Ltd.

phone: +82 31 337 7700~3
info-kr@sensirion.com
www.sensirion.com/kr



Sensirion China Co. Ltd.

phone: +86 755 8252 1501
info-cn@sensirion.com
www.sensirion.com/cn

To find your local representative, please visit
<http://www.sensirion.com/distributors>

Looking for pricing, stock, or lifecycle information?

Click below to explore more details on WIN SOURCE:

-  [View SGP41-D-R4 on WIN SOURCE](#)
-  [Sensirion AG Information](#)

Optimize Your Supply Chain with WIN SOURCE Solutions

-  Global Sourcing Solution
-  Obsolete Management
-  Cost Control Management
-  Shortage Management
-  Alternative Solution
-  Excess Inventory Management