



**THE DATASHEET OF
691701310004B**



1

2

3

4

5

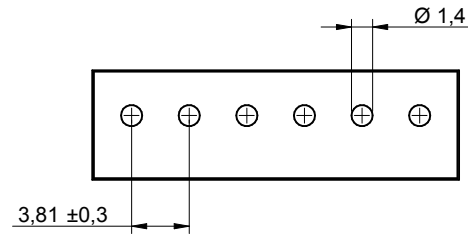

RECOMMENDED PCB LAYOUT - COMPONENT VIEW

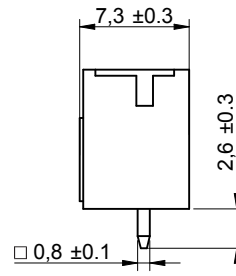
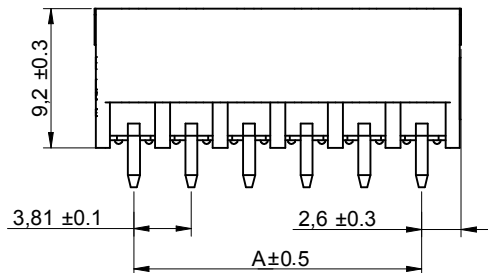
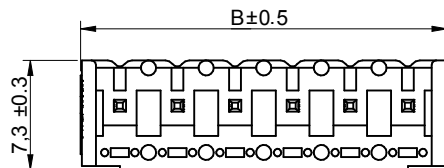

Poles	A	B
2	3.81	9.01
3	7.62	12.82
4	11.43	16.63
5	15.24	20.44
6	19.05	24.25
7	22.86	28.06
8	26.67	31.87
9	30.48	35.68
10	34.29	39.49
11	38.1	43.3
12	41.91	47.11

CHARACTERISTICS

MATERIAL

Insulator material : LCP

Flammability rating : UL94-V0

Colour : Black

Contact pin : Brass (CuZn)

Surface of solder tail plating : Tin Plated

ENVIRONMENTAL

Operating temperature : -40°C up to 105°C

Compliance : Lead free and RoHS

SOLDERING

Solder temperature : Reflow process as per JEDEC J-020D-STD

ELECTRICAL

Current rating : 10A

Working voltage : 300 Vac

Dielectric withstanding voltage : 2.5 kVac/min

Contact resistance : 20 mΩ max

STANDARD

cULus Certified : E315414 / Model number 7013

MECHANICAL

Pitch : 3.81mm

PACKAGING

Tape & Reel with cap

RoHS Compliant

G			
F			
E			
D			
C	29-JUL-13	DWG REVIEW	QL
B	19-DEC-11	6917013100xx	QL
A	14-SEP-11	PDF	QL
REV	DATE	FILE	BY

PROJECTION:

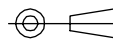

APPROVAL: RJ

GENERAL TOLERANCE

.X = \pm 0.2.XX = \pm 0.15

UNIT: MM

SCALE: 2/1

SHEET: 1/2

DRAW: QUENTIN



DESCRIPTION: SERIE 7013B - 3.81MM VERTICAL PCB HEADER - THR TYPE

SIZE

WERI PART NO: 691 701 310 0xx B

A4

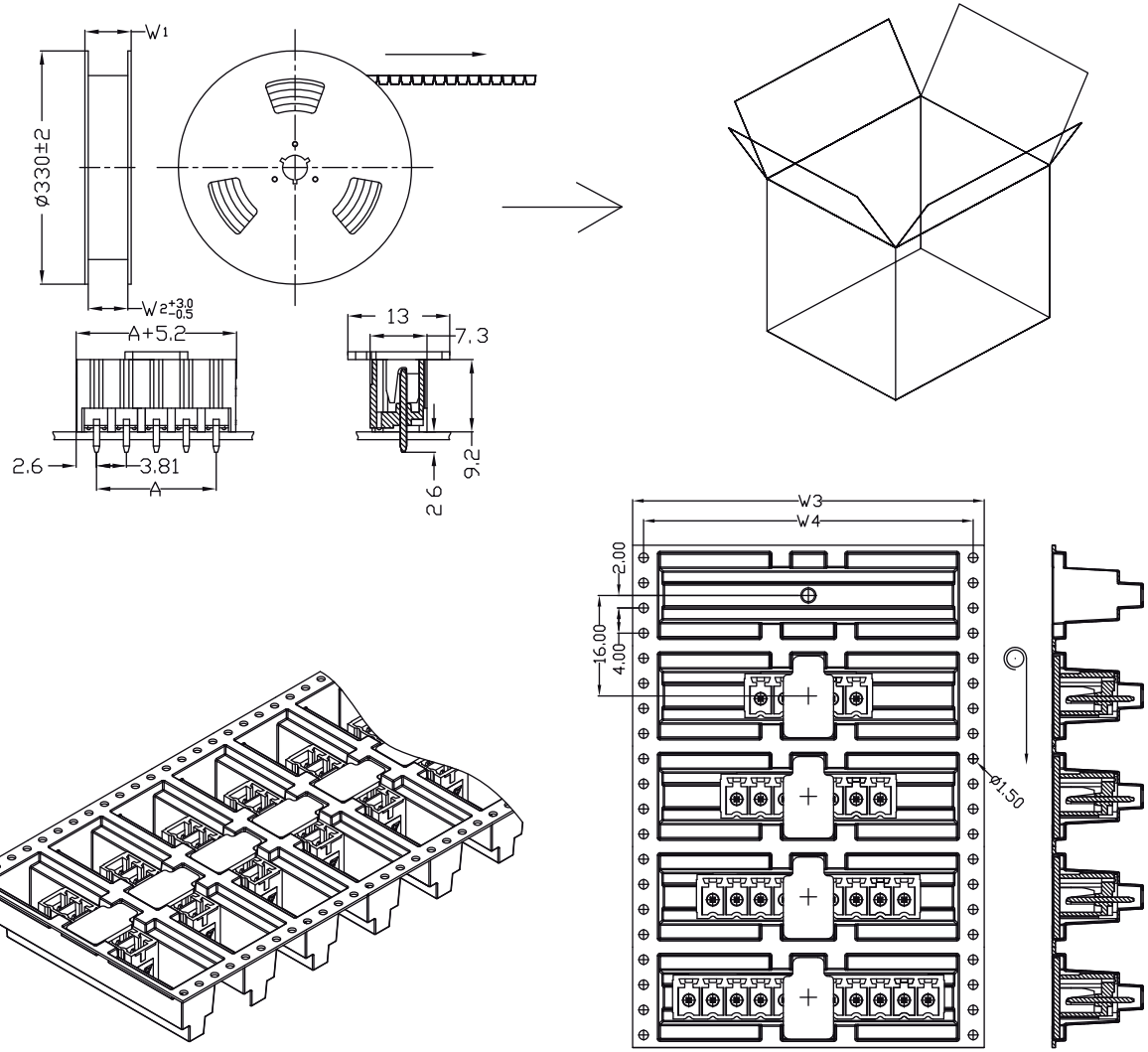

1. 10 sprocket hole pitch cumulative tolerance ± 0.20
2. Carrier camber is within 1 mm in 250 mm.
3. Material : Black Conductive Polystyrene Alloy.
Transparent anti-static PET
4. All dimensions meet EIA-481-C requirements.
5. Thickness : 0.50 ± 0.05 mm.
6. Component load per 13" reel : 250 pcs.

Poles	A	Dimension				Reel / carton	Carton dimensions (cm)	Quantity / Carton
		W1(mm)	W2(mm)	W3(mm)	W4(mm)			
2	3.81	36.4	32	32	28.4	10	33.5 x 33.5 x 40	2500
3	7.62	36.4	32	32	28.4	10	33.5 x 33.5 x 40	2500
4	11.43	36.4	32	32	28.4	10	33.5 x 33.5 x 40	2500
5	15.24	60.4	56	56	52.5	6	33.5 x 33.5 x 40	1500
6	19.05	60.4	56	56	52.5	6	33.5 x 33.5 x 40	1500
7	22.86	60.4	56	56	52.5	6	33.5 x 33.5 x 40	1500
8	26.67	60.4	56	56	52.5	6	33.5 x 33.5 x 40	1500
9	30.48	60.4	56	56	52.5	6	33.5 x 33.5 x 40	1500
10	34.29	60.4	56	56	52.5	6	33.5 x 33.5 x 40	1500
11	38.1	76.4	72	72	68.5	5	33.5 x 33.5 x 40	1250
12	41.91	76.4	72	72	68.5	5	33.5 x 33.5 x 40	1250

RoHS Compliant			
G			
F			
E			
D			
C			
B			
A			
REV	DATE	FILE	BY

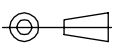
PROJECTION:

 APPROVAL: RJ

GENERAL TOLERANCE
 .X = ± 0.2
 .XX = ± 0.15
 UNIT: MM
 SCALE:
 SHEET: 2/2
 DRAW: QUENTIN



DESCRIPTION: SERIE 7013B - 3.81MM VERTICAL PCB HEADER - THR TYPE
 WERI PART NO: 691 701 310 0xx B

SIZE
A4

Looking for pricing, stock, or lifecycle information?

Click below to explore more details on WIN SOURCE:

 [View 691701310004B on WIN SOURCE](#)

 [Wurth Electronics Inc Information](#)

Optimize Your Supply Chain with WIN SOURCE Solutions

-  Global Sourcing Solution
-  Obsolete Management
-  Cost Control Management
-  Shortage Management
-  Alternative Solution
-  Excess Inventory Management