



THE DATASHEET OF DLM0NSB280HY2D



Reference Only

Spec No. JEFL243D-0009M-01

P1/11

Chip Common Mode Choke Coil DLM0NS□□□□HY2□

Reference Specification

1. Scope

This reference specification applies to Chip Common Mode Choke Coil DLM0NS Series for differential signal interface in Electronics.

2. Part Numbering

(ex.) DL M 0N S B 120 H Y 2 D
 (1) (2) (3) (4) (5) (6) (7) (8) (9) (10)

- | | |
|----------------------------------------------------|-------------------------------------------------------|
| (1) Chip Common Mode Choke Coil | (6) Impedance (Typ. at 100MHz) |
| (2) Structure (M : Monolithic Type) | (7) Circuit H : Characteristic Impedance 100 Ω system |
| (3) Dimension (L×W) | (8) Features |
| (4) Type S: Magnetically shielded one circuit type | (9) Number of Line |
| (5) Category | (10) Packaging Code D : Taping / B : Bulk |

3. Rating

Customer Part Number	Murata Part Number	Common Mode Impedance (at 100MHz, Under Standard Testing Condition)	Rated Voltage	Withstanding Voltage	Rated Current	DC Resistance	Insulation Resistance	Cut-off Frequency
	DLM0NSB120HY2D	12 Ω ± 5 Ω	5V(DC)	12.5V(DC)	160mA	1.2 Ω ± 25%	10M Ω min.	8GHz(Typ.)
	DLM0NSB120HY2B				130mA			
	DLM0NSB280HY2D	28 Ω ± 30%	5V(DC)	12.5V(DC)	100mA	1.9 Ω ± 25%	10M Ω min.	5GHz(Typ.)
	DLM0NSB280HY2B							
	DLM0NSN500HY2D	50 Ω ± 25%	5V(DC)	12.5V(DC)	100mA	2.7 Ω ± 25%	10M Ω min.	2GHz(Typ.)
	DLM0NSN500HY2B							
	DLM0NSN900HY2D	90 Ω ± 25%	5V(DC)	12.5V(DC)	100mA	4.0 Ω ± 25%	10M Ω min.	5GHz(Typ.)
	DLM0NSN900HY2B							
	DLM0NSM900HY2D	90 Ω ± 25%	5V(DC)	12.5V(DC)	100mA	3.8 Ω ± 25%	10M Ω min.	5GHz(Typ.)
	DLM0NSM900HY2B							

Operating Temperature : -40 to +85°C

Storage Temperature : -40 to +85°C

4. Standard Testing Conditions

<Unless otherwise specified>

Temperature : Ordinary Temperature 15 to 35°C
 Humidity : Ordinary Humidity 25 to 85%(RH)

<In case of doubt>

Temperature : 20 ± 2°C
 Humidity : 60 to 70%(RH)
 Atmospheric Pressure : 86 to 106kPa

5. Style and Dimensions

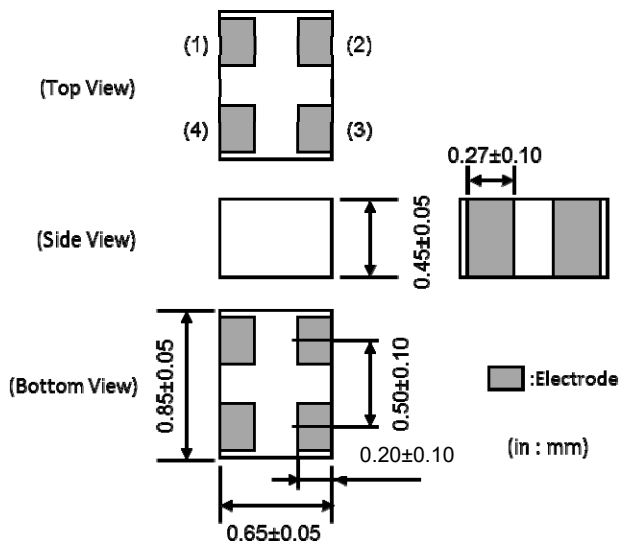

Equivalent Circuits

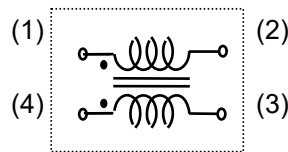

No polarity

Unit Mass(Typical value)

0.9mg

Reference Only

6. Marking

No Marking.

7. Electrical Performance

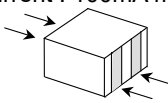
No.	Item	Specification	Test Method
7.1	Common Mode Impedance	Meet item 3.	Measuring Frequency : 100±1MHz (ref.item 10.) Measuring Equipment : KEYSIGHT 4291A or the equivalents (In case of doubt in standard condition, the heat treatment(200°C, about 10 min) shall be applied.
7.2	Withstanding Voltage	Products shall not be damaged.	Test Voltage : 2.5 times for Rated Voltage Time : 1 to 5s Charge Current : 1 mA max.(ref.item 10.)
7.3	DC Resistance (Rdc)	Meet item 3.	Measuring current : 100mA max.(ref.item 10.) 
7.4	Insulation Resistance (I.R.)		Measuring voltage : Rated Voltage Measuring time : 1 min max. (ref.item 10.)

8. Mechanical Performance

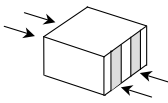
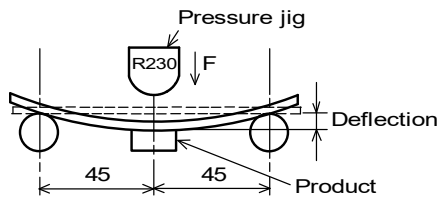
No.	Item	Specification	Test Method
8.1	Appearance and Dimensions	Meet item 5.	Visual Inspection and measured with Slide Calipers.
8.2	Solderability	The electrodes shall be at least 95% covered with new solder coating. 	Flux : Ethanol solution of rosin,25(wt)% Pre-Heating : 150±10°C, 60~90s Solder : Sn-3.0Ag-0.5Cu Solder Temperature : 230±3°C Immersion Time : 3±0.5s Immersion and emersion rates : 25 mm / s
8.3	Resistance to Soldering Heat	Meet Table 1. <u>Table 1</u>	Flux : Ethanol solution of rosin,25(wt)% Pre-Heating : 150±10°C, 60~90s Solder : Sn-3.0Ag-0.5Cu Solder Temperature : 270±5°C Immersion Time : 5±1s Immersion and emersion rates : 25 mm / s Then measured after exposure in the room condition for 4h to 48h.
8.4	Drop	DC Resistance Change within ± 30%	It shall be dropped on concrete or steel board. Method : free fall Height : 1m The Number of Times : 10 times
8.5	Vibration		It shall be soldered on the substrate. Oscillation Frequency : 10 to 2000 for 20 min Total amplitude : 3.0 mm or Acceleration amplitude 196 m/s ² whichever is smaller. Testing Time : A period of 4 hours in each of 3 mutually perpendicular directions.
8.6	Bending Strength	Meet Table 2. <u>Table 2</u>	Substrate : (t =1.0 mm). Deflection : 2 mm Speed of Applying Force : 1.0 mm / s Keeping time : 60s 

Reference Only

Spec No. JEFL243D-0009M-01

P3/11

9. Environmental Performance (Products shall be soldered on the glass-epoxy substrate)

No.	Item	Specification	Test Method
9.1	Temperature Cycle	Meet Table 1.	1 Cycle Step 1 -40°C(+0°C,-3°C) / 30(+3,-0) min Step 2 Ordinary Temp. / within 3 min Step 3 +85(+2°C,-0°C) / 30(+3,-0) min Step 4 Ordinary Temp. / within 3 min Total of 100 cycles. Then measured after exposure in the room condition for 4h to 48h.
9.2	Humidity		Temperature : 40±2°C Humidity : 90 to 95 % (RH) Time : 1000h (+48h,-0h) Then measured after exposure in the room condition for 4h to 48h.
9.3	Heat life		Temperature : 85±2°C Test Voltage : 2 times for Rated Voltage Time : 1000h (+48h,-0h) Then measured after exposure in the room condition for 4h to 48h. (ref. Item 10.)
9.4	Cold Resistance		Temperature : -40± 2°C Time : 1000h (+48h,-0h) Then measured after exposure in the room condition for 4h to 48h.

10. Terminal to be Tested.

When measuring and supplying the voltage, the following terminal is applied.

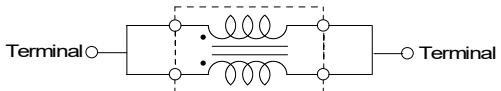
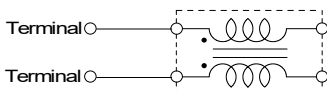
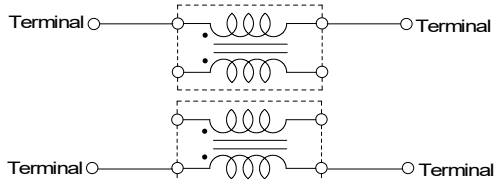
No.	Item	Terminal to be Tested
10.1	Common Mode Impedance	
10.2	Withstanding Voltage Insulation Resistance Heat Life	
10.3	DC Resistance	

11. Measuring method for common mode impedance.

Measured common mode impedance may be included measurement error due to stray capacitance, residual inductance of test fixture.

To correct this error, the common mode impedance should be calculate as follows;

- (1) Measure admittance of the fixture(opened), G_o B_o .
- (2) Measure impedance of the fixture(shorted), R_s X_s .
- (3) Measure admittance of the specimen, G_m B_m .
- (4) Calculate corrected impedance $|Z|$ using the formula below.

$$|Z| = (R_x^2 + X_x^2)^{1/2}$$

Where

$$R_x = \frac{G_m - G_o}{(G_m - G_o)^2 + (B_m - B_o)^2} - R_s$$

$$X_x = \frac{-(B_m - B_o)}{(G_m - G_o)^2 + (B_m - B_o)^2} - X_s$$

12. P.C.B., Flux, Solder and Soldering condition

Test shall be done using P.C.B., Flux, Solder and Soldering condition which are specified in item 16 except the case of being specified special condition.

13. Impedance Frequency Characteristics (Typical)

DLM0NSB120HY2

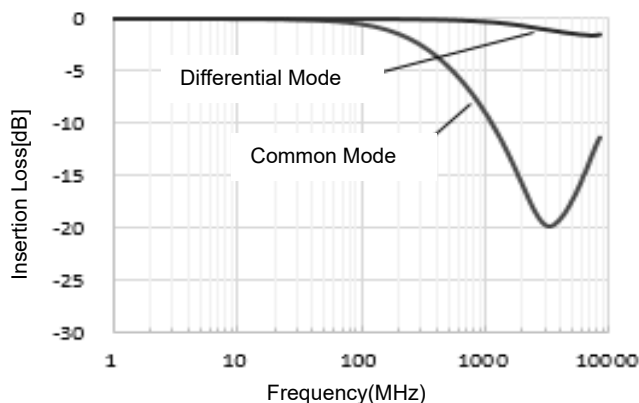
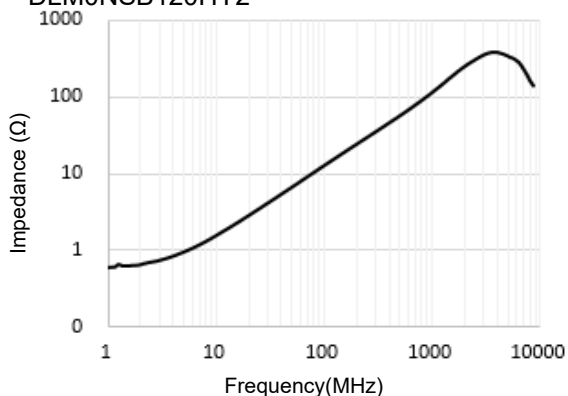

DLM0NSB280HY2

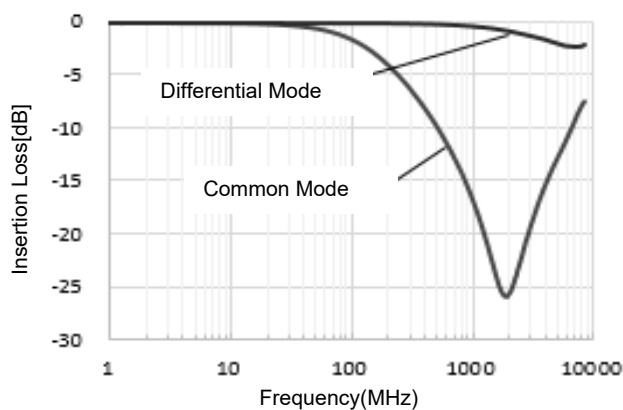
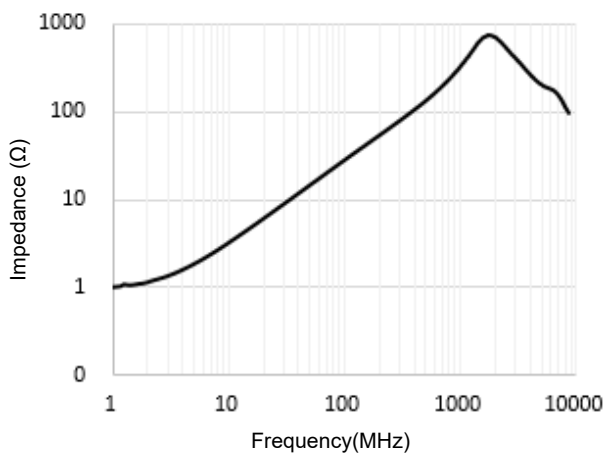

DLM0NSN500HY2

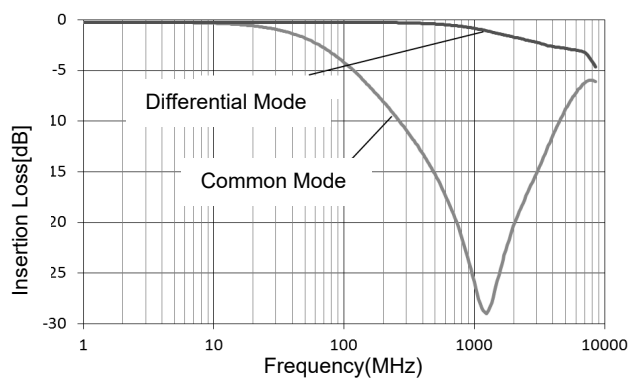
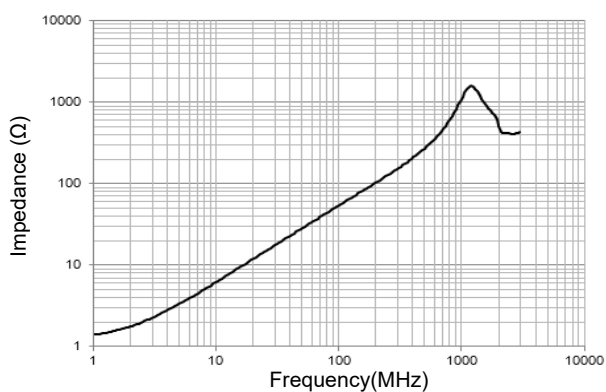

DLM0NSN900HY2

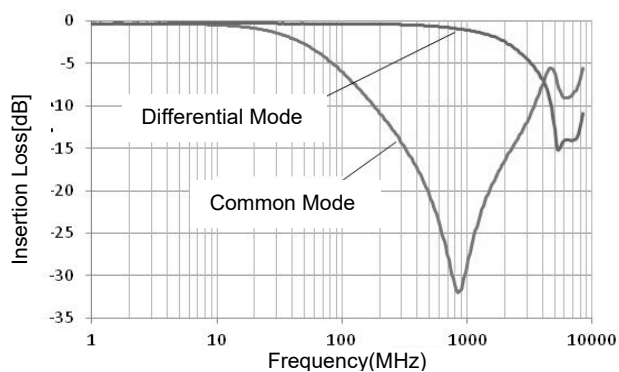
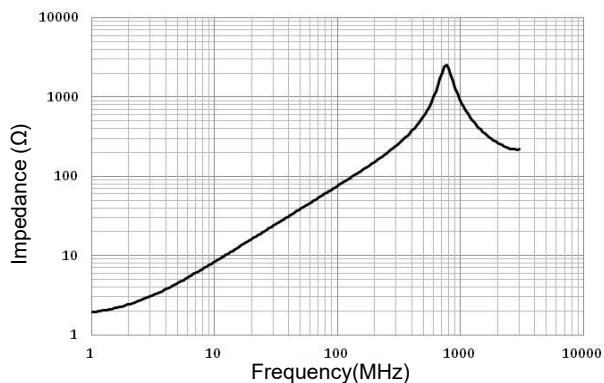

DLM0NSM900HY2

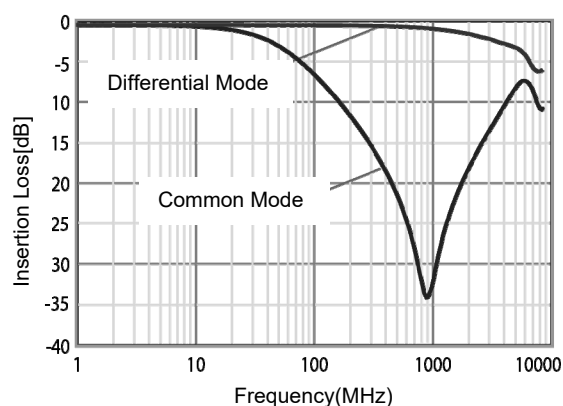
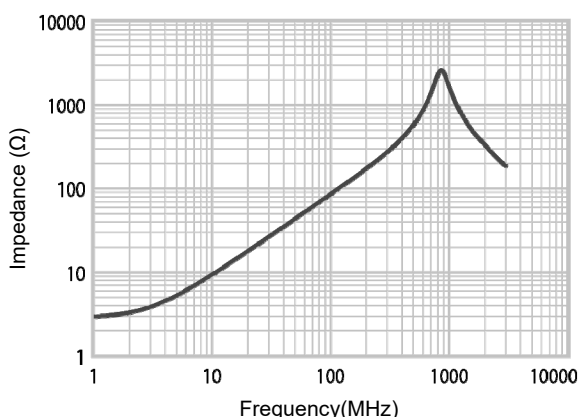

14. Specification of Packaging Frequency

14.1 Appearance and Dimensions (8mm-wide, 2mm pitch Paper tape)

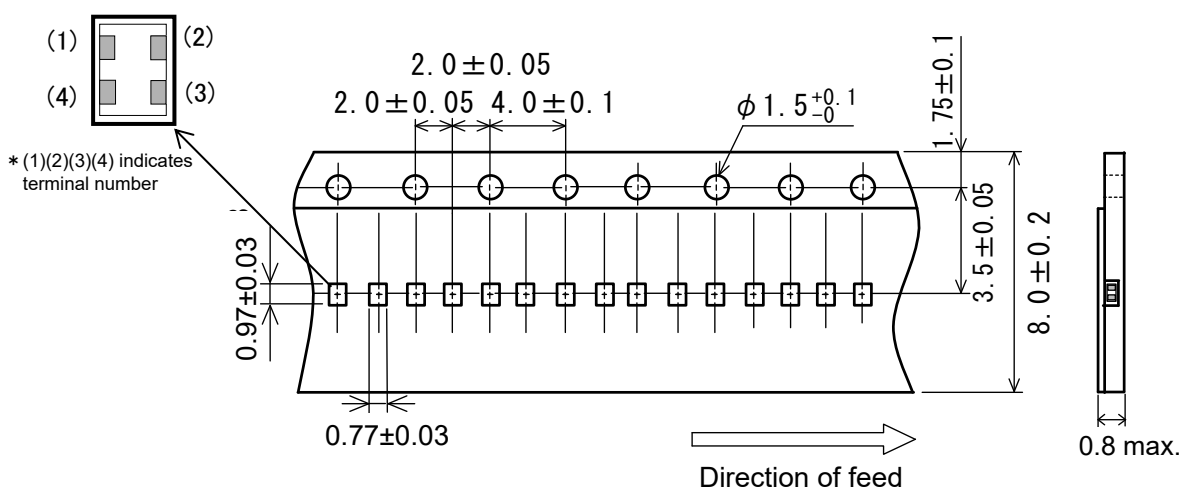

(in:mm)

14.2 Specification of Taping

- (1)Packing quantity(Standard quantity) 10,000 pcs. / reel
- (2)Packing Method
Products shall be packed in the cavity of the base tape and sealed by Cover tape.
- (3)Sprocket Hole
The sprocket holes are to the right as the tape is pulled toward the user.
- (4)Spliced point
The cover tape have no spliced point.
- (5)Missing components number
Missing components number within 0.1% of the number per reel or 1 pc., whichever is greater, and are not continuous. The specified quantity per reel is kept.

14.3 Pull Strength of Paper Tape

Paper Tape	5N min.
Cover Tape	10N min.

14.4 Peeling off force of Cover Tape

0.1 to 0.6N(Minimum value is Typical)
Speed of Peeling off : 300 mm/min.

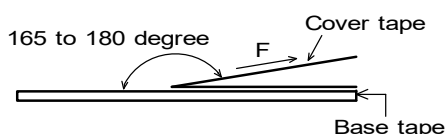

Reference Only

14.5 Dimensions of Leader-tape, Trailer and Reel

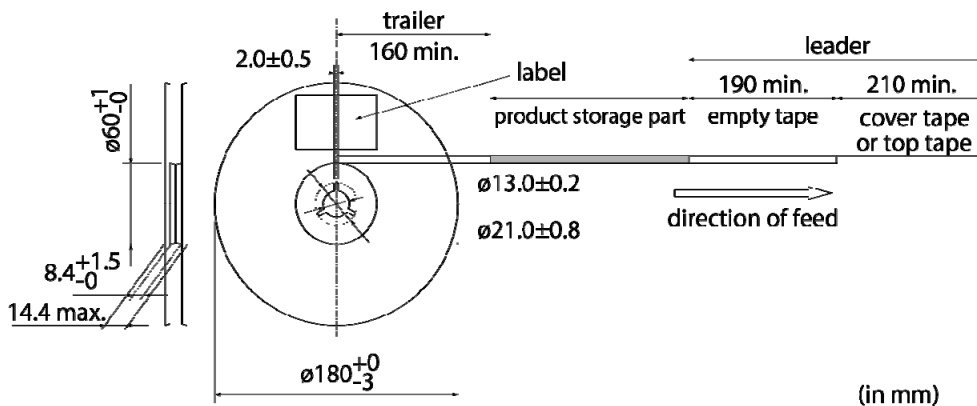

14.6 Marking for reel

Customer part number, MURATA part number, Inspection number(*1), RoHS marking(*2), Quantity, etc

*1) « Expression of Inspection No. »

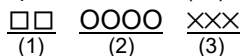

- (1) Factory Code
- (2) Date

First digit : Year / Last digit of year
 Second digit : Month / Jan. to Sep. → 1 to 9, Oct. to Dec. → O, N, D
 Third, Fourth digit : Day

- (3) Serial No.

*2) « Expression of RoHS marking »

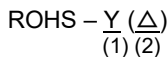

- (1) RoHS regulation conformity parts.
- (2) MURATA classification number

14.7 Marking for Outside package

Customer name Purchasing Order Number, Customer Part Number, MURATA part number, RoHS marking(*2), Quantity, etc

14.8 Specification of Outer Case

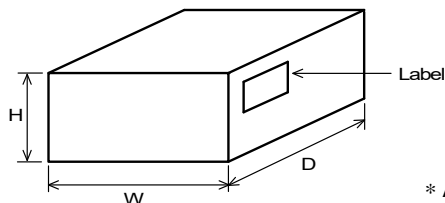

Outer Case Dimensions (mm)			Standard Reel Quantity in Outer Case (Reel)
W	D	H	
186	186	93	5

* Above Outer Case size is typical. It depends on a quantity of an order.

15. ⚠ Caution

15.1 Mounting Direction

Mount products in right direction.

Wrong direction which is 90° rotated from right direction causes not only open or short circuit but also flames or other serious trouble.

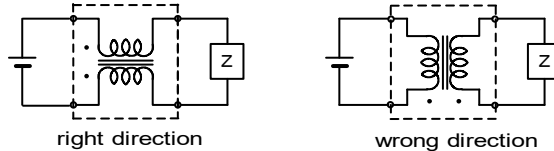

15.2 Limitation of Applications

Please contact us before using our products for the applications listed below which require especially high reliability for the prevention of defects which might directly cause damage to the third party's life, body or property.

- (1) Aircraft equipment
- (2) Aerospace equipment
- (3) Undersea equipment
- (4) Power plant control equipment
- (5) Medical equipment
- (6) Transportation equipment (vehicles, trains, ships, etc.)
- (7) Traffic signal equipment
- (8) Disaster prevention / crime prevention equipment
- (9) Data-processing equipment
- (10) Applications of similar complexity and / or reliability requirements to the applications listed in the above.

15.3 Corrosive gas

Please refrain from use since contact with environments with corrosive gases (sulfur gas [hydrogen sulfide, sulfur dioxide, etc.], chlorine, ammonia, etc.) or oils (cutting oil, silicone oil, etc.) that have come into contact with the previously stated corrosive gas environment will result in deterioration of product quality or an open from deterioration due to corrosion of product electrode, etc. We will not bear any responsibility for use under these environments.

16. Notice

This product is designed for solder mounting. (reflow soldering only)
Please consult us in advance for applying other mounting method such as conductive adhesive.

16.1 Flux and Solder

Flux	Use rosin-based flux, but not highly acidic flux (with chlorine content exceeding 0.2(wt)%.) Do not use water-soluble flux.
Solder	Use Sn-3.0Ag-0.5Cu solder Use of Sn-Zn based solder will deteriorate performance of products. In case of using Sn-Zn based solder, please contact Murata in advance.

16.2 Assembling

<Thermal Shock>

Pre-heating should be in such a way that the temperature difference between solder and ceramic surface is limited to 100°C MAX. Also cooling into solvent after soldering should be in such a way that the temperature difference is limited to 100°C max.

16.3 Resin coating

The impedance value may change and/or it may affect on the product's performance due to high cure-stress of resin to be used for coating / molding products. So please pay your careful attention when you select resin. In prior to use, please make the reliability evaluation with the product mounted in your application set.

16.4 Attention regarding P.C.B. bending

The following shall be considered when designing and laying out P.C.B.'s.

- (1) P.C.B. shall be designed so that products are not subject to the mechanical stress due to warping the board.

[Products direction]

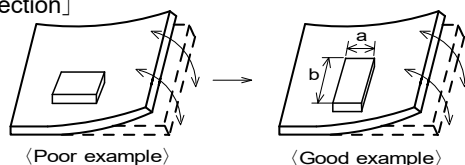

Products shall be location the sideways Direction (Length : a>b) to the mechanical Stress.

[Warping direction]

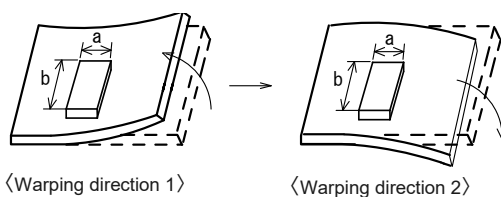

Products(warping direction 1, warping direction 2) shall be located carefully so that products are not subject to the mechanical stress due to warping the board. Because they may be subjected the mechanical stress in order of warping direction 1>warping direction 2.

- (2) Components location on P.C.B. separation

It is effective to implement the following measures, to reduce stress in separating the board.

It is best to implement all of the following three measures; however, implement as many measures as possible to reduce stress.

Contents of Measures	Stress Level
(1) Turn the mounting direction of the component parallel to the board separation surface.	A > D *1
(2) Add slits in the board separation part.	A > B
(3) Keep the mounting position of the component away from the board separation surface.	A > C

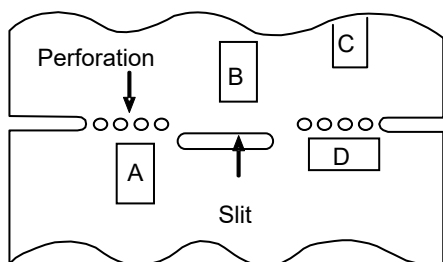

*1 A > D is valid when stress is added vertically to the perforation as with Hand Separation. If a Cutting Disc is used, stress will be diagonal to the PCB, therefore A > D is invalid.

(3) Mounting Components Near Screw Holes

When a component is mounted near a screw hole, it may be affected by the board deflection that occurs during the tightening of the screw. Mount the component in a position as far away from the screw holes as possible.

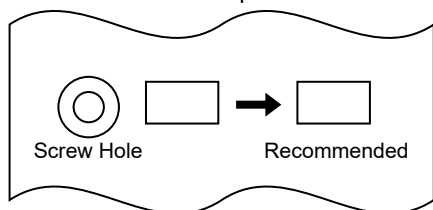

16.5 Attention Regarding P.C.B. Design

< The Arrangement of Products >

P.C.B. shall be designed so that products are far from the portion of perforation.

The portion of perforation shall be designed as narrow as possible, and shall be designed so as not to be applied the stress in the case of P.C.B. separation.

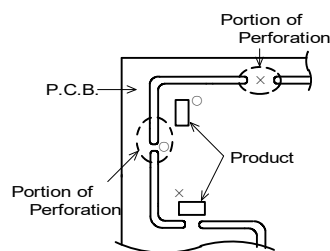

Products shall not be arranged on the line of a series of holes when there are big holes in P.C.B. (Because the stress concentrate on the line of holes.)

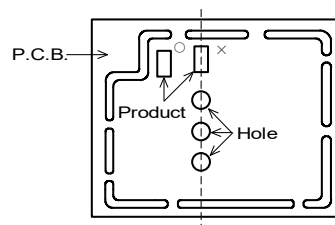

< Products Placing >

Support pins shall be set under P.C.B. to prevent causing a warp to P.C.B. during placing the products on the other side of P.C.B.

< P.C.B. Separation >

P.C.B. shall not be separated with hand.
P.C.B. shall be separated with the fixture so as not to cause P.C.B. bending.

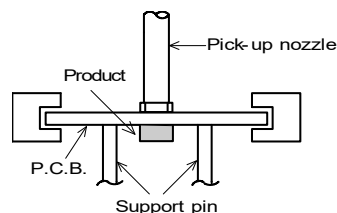

16.6 Attention Regarding P.C.B. Mounting

In case of mounting by use of mounting machine, please choose nozzle which can pick up components of 0603 size.

16.7 Standard Land Dimensions

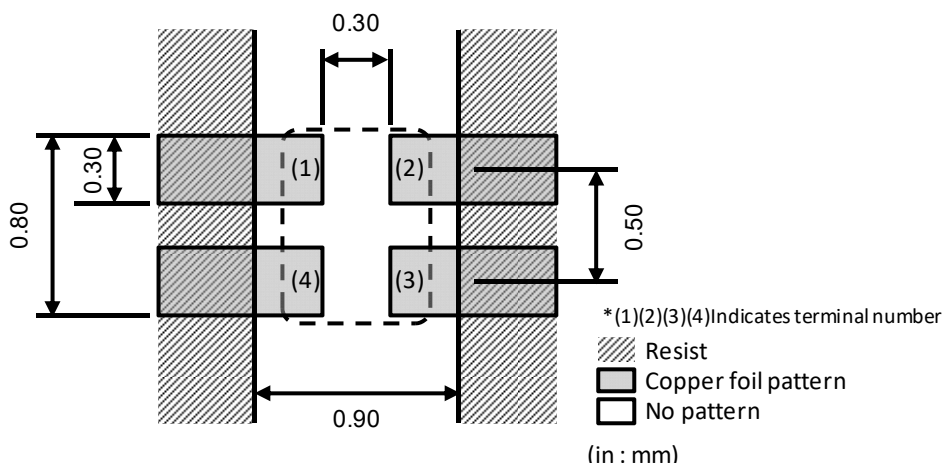

16.8 Soldering(Reflow soldering)

Standard soldering profile and the limit soldering profile is as follows.

The excessive limit soldering conditions may cause leaching of the electrode and / or resulting in the deterioration of product quality.

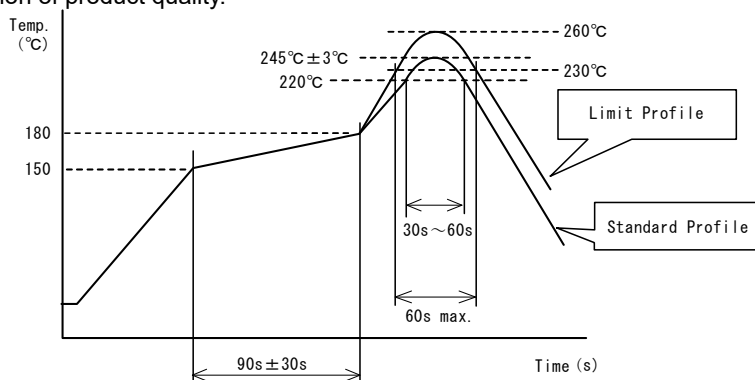

	Standard Profile	Limit Profile
Pre-heating	150~180°C、90s±30s	
Heating	above 220°C、30s~60s	above 230°C、60s max.
Peak temperature	245±3°C	260°C、10s
Cycle of reflow	2 times	2 times

(1) Standard printing pattern of solder paste

- Standard thickness of the solder paste should be 100 to 150μm.
- Use the solder paste printing pattern of the right pattern.
- For the resist and copper foil pattern, use standard land dimensions.
- Use Sn-3.0Ag-0.5Cu solder.

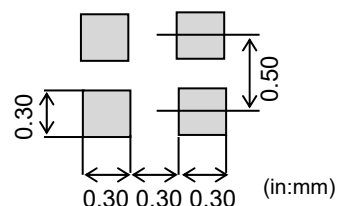

(2) Reworking with Soldering iron

- The following conditions shall be strictly followed when using a soldering iron after being mounted by reflow soldering.
 - Pre-heating: 150°C, 1 min
 - Soldering iron output: 30W max.
 - Tip temperature: 380°C max.
 - Tip diameter: φ3mm max.
 - Soldering time : 3(+1,-0) seconds.
 - Times : 2times max.
- Do not touch the products directly with the tip of the soldering iron.

Reference Only

Spec No.JEFL243D-0009M-01

P11/11

17. Note

- (1) Please make sure that your product has been evaluated in view of your specifications with our product being mounted to your product.
- (2) You are requested not to use our product deviating from the reference specifications.
- (3) The contents of this reference specification are subject to change without advance notice. Please approve our product specifications or transact the approval sheet for product specifications before ordering.

Looking for pricing, stock, or lifecycle information?

Click below to explore more details on WIN SOURCE:

- ⊖ [View DLM0NSB280HY2D on WIN SOURCE](#)
- ⊖ [Murata Electronics North America Information](#)

Optimize Your Supply Chain with WIN SOURCE Solutions

- ✓ Global Sourcing Solution
- ✓ Obsolete Management
- ✓ Cost Control Management
- ✓ Shortage Management
- ✓ Alternative Solution
- ✓ Excess Inventory Management