

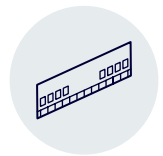

**THE DATASHEET OF  
RP164PJ000CS**

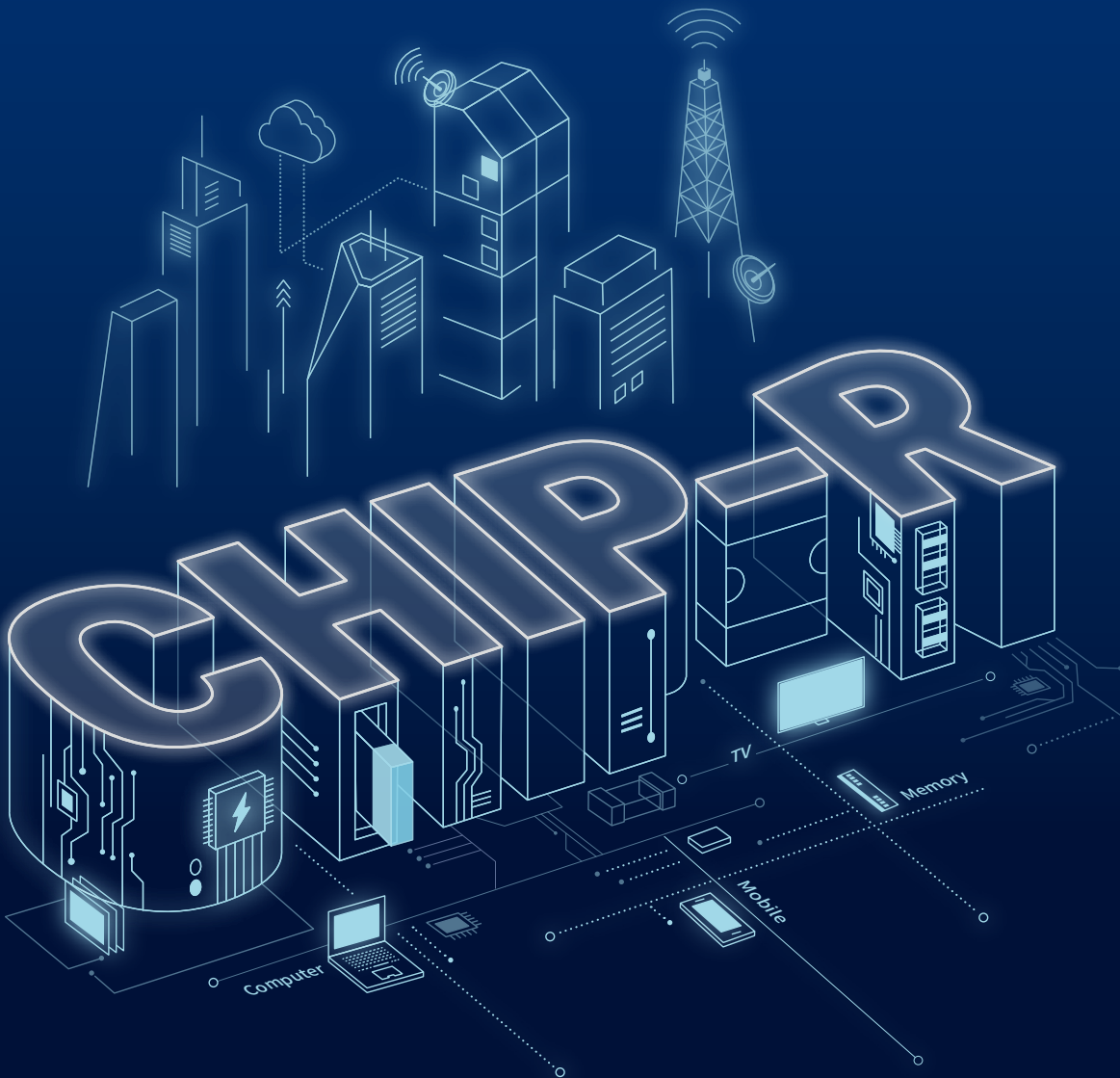

Mar 2022



# CHIP RESISTORS

SAMSUNG  
ELECTRO-MECHANICS



# CHIP RESISTORS



**We, Samsung, declare that our component Chip Resistor is produced in accordance with EU RoHS directive.**

## 1. RoHS Compliance and restriction of Br

The following restricted materials are not used in packaging materials as well as products in compliance with the law and restriction.

- Cd, Pb, Hg, Cr6+, As, Br and the compounds, PCB, asbestos
- Bromic materials : PBBs, PBBOs, PBDO, PBDE, PBB
- Phthalate materials : DEHP, BBP, DBP, DIBP

## 2. No use of materials breaking Ozone layer

The following ODS materials are not used in our fabrication process.

- ODS material : Freon, Haron, 1-1-1 TCE, CCl<sub>4</sub>, HCFC

**If you want more information, please visit the website of Samsung Electro-mechanics**

[<http://www.sem.samsung.com>, <http://www.semlcr.com>]

## C O N T E N T S

<b>04</b>	Product Characteristic data Notes
<b>10</b>	General_Standard Standard(RC), Reverse(RCB)
<b>14</b>	Array Type Resistor Flat Type(RF, RM), Concave Type(RN, RM, RK), Convex Type(RP)
<b>20</b>	General_Current Sensing Resistor(CSR) Low ohms(RUT), Ultra Low ohms(RU, RUK), Wide Terminal(RJ)
<b>28</b>	Metal_Current Sensing Resistor(M_CSR) Metal Plate_Clad Type(RLP, RLC)
<b>30</b>	High Power Chip Resistor General Standard(RCW)
<b>32</b>	High Voltage Chip Resistor (RCV)
<b>34</b>	Anti-Sulfur Resistor General Standard(RCS), Flat Type(RFS), Convex Type(RPS)
<b>36</b>	Lead free Chip Resistor General Standard, Array Type, Anti-Sulfur Type
<b>38</b>	Center Common Array Resistor(CCA) 3-Terminal Array Type(RFT)
<b>40</b>	Characteristics Performance
<b>44</b>	Packaging
<b>46</b>	Standard Resistance Value
<b>47</b>	Caution/Notice Electrical & Mechanical Caution, Process of Mounting, Soldering, Designing and Others.
<b>66</b>	Component sales offices/manufacturing sites

# Product Characteristic data Notes

Please be advised that this is a standard product specification for a reference only.

## Measurement of Resistance Value

- Apply DC voltage specified in the product specifications and measure R-value at room temperature.
- As the voltage applied is different for the different resistance range, the voltage corresponding to the resistance range must be applied. Since the voltage (current) is applied to most standard measuring instruments automatically, the standard measuring instrument must be used.
- For a reduction of an electrical noise, it is recommended to use 4-terminal measuring instrument in order to minimize linear resistance.
- When measuring the chip on PCB, the PCB must be same as reference, to reduce the differences depending on PCB (Fig. 3).
- Standard voltage value for each resistance range is according to the JIS standard. (JIS C 5201-1 (4.5))

## Rated Voltage

- The rated voltage in resistance is the DC continuous working voltage corresponding to rated power or AC (rms) voltage in the commercial line frequency waveform. It is calculated with the following formula. If the value calculated with the formula exceeds Max working voltage, rated voltage is limited to max working voltage. That is, after calculating E value with the formula, the lower value is the rated voltage between the E value calculated with the formula and max working voltage.

$$E = \sqrt{P \times R}$$

E: Rated Voltage (V)    P: Rated Power (W)    R: Nominal Resistance (Ω)

- When the rated voltage is applied to the resistor, ambient temperature must be checked and load power must be decreased according to the power derating curve.
- If the voltage is higher than rated voltage, it is not guaranteed to have reliability and a performance of the resistor. For inquiries about any other conditions, please contact a person in charge of sales.
- If a pulse waveform is applied to resistance, the max value of pulses must be within the rated voltage.

## Max Working Voltage (Max Rated Voltage)

- It refers to max DC or AC (rms) voltage that can be applied to a resistor constantly. As this given voltage is set by size, the rated voltage of a resistor must not exceed max working voltage.
- Voltage that can be applied is limited by size and is referred to as max working voltage. Voltage that can be applied is limited by size, which is referred to as max working voltage.
- If Rated Voltage > Max Working Voltage, max working voltage must be used as rated voltage. If Rated Voltage < Max Working Voltage, the rated voltage shall be used.

### Ex) For RC1608 Series [P = 0.1(W), Max working voltage = 50(V)]

1) The rated voltage, when R = 1KΩ

$$E = \sqrt{0.1 \times 1000} = 10V$$

Value is lower than Max working voltage,  
therefore  $E = 10(V)$

2) The rated voltage, when R = 100KΩ

$$E = \sqrt{0.1 \times 100000} = 100V$$

Value is higher than Max working voltage,  
therefore  $E = 50(V)$

## Max Working Voltage

(Unit: V)

Item \ Dim	0402 (01005)	0603 (0201)	1005 (0402)	1608 (0603)	2012 (0805)	3216 (1206)	3225 (1210)	5025 (2010)	6432 (2512)
Max Working	15	25	50	50	150	200	200	200	200

## Critical Resistance Value

- It refers to max resistance value that rated current can be loaded without exceeding max working voltage. Rated voltage is same with max working voltage in critical resistance value.
- Depending on R-value, rated voltage increases as A in Fig. 1 and max working voltage shall be applied when it is higher than max working voltage.
- The resistor value to apply max working voltage at the first is referred to as critical resistance value. In the resistance range over the critical resistance value, max working voltage in Fig.1 shall be applied so that voltage can be constant, resulting in decreasing power.

General\_Standard Standard(RC)

General\_Standard Reverse(RCB)

Array Type Resistor Flat(RF, RM)

Array Type Resistor Concave(RN, RM, RK)

Array Type Resistor Convex(RP)

Current Sensing Resistor Low ohms(RUT)

Current Sensing Resistor Ultra Low ohms(RU, RUK)

Current Sensing Resistor Wide Terminal(RJ)

Metal\_CSR Metal Plate\_Clad(RLP,RLC)

High Power Resistor General(RCW)

High Voltage Chip Resistor (RCV)

Anti-Sulfur Resistor General, Array(RCS, RFS, RPS)

Lead free Chip Resistor General, Array, AntiSulfur

Center Common Array 3-Terminal Array(RFT)

Characteristics Performance

Packaging

Standard Resistance Value

Electrical & Mechanical Caution

Process of Mounting Soldering, Design

Caution of Application

# Product Characteristic data Notes

## Power Derating Curve

- The rated power is the power of load power regulation that suits for continuous use at 70°C. If ambient temperature is higher than 70°C, it decreases load power according to the rated power derating curve in Fig. 2.
- In case that internal temperature does not use a resistor in designing circuit, its temperature is below 70°C, power guaranteed by our company shall be reflected 100% in design. However, if it exceeds 70°C, applied power must be reduced as temperature goes higher by referring to Fig. 2.

Ex) As for 1005, temperature is at 70°C below, 100% (0.1W) of rated power can be applied but, when its temperature at 100°C, 0.07W that is 70% of rated power must be applied.

Fig. 2 (Power Derating Curve)

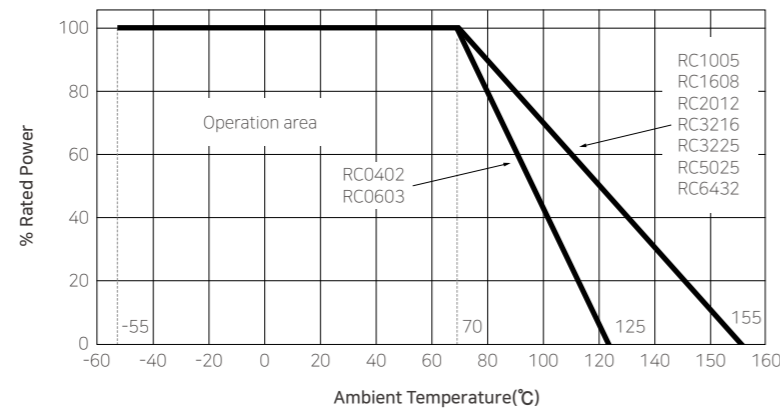

## R-value Marking

- Mark Existence.

Size	0402	0603	1005	1608	2012	3216	3225	5025	6432
Mark.	3Digit	-	-	-	○	○	○	○	○
	4Digit	-	-	-	-	○	○	○	○

- R-value shall be marked with 3 or 4-digit numbers in accordance with the IEC standard, and decimal point shall be marked as "R".
- Use 4-digit numbers for D- and F-grades and 3-digit numbers for J-grade based on the marking criteria.
- The following criteria shall be applied.
  - 1) Products shall be marked on the top side and a jumper shall be marked as "000".
  - 2) Examples of Marking
 

RC2012J000CS	(2012, Max 50mohm)	Marking = "000"
RC2012J103CS	(2012, ±5%, 10Kohm, E-24)	Marking = 103
RC2012F1002CS	(2012, ±1%, 10Kohm, E-24)	Marking = 1002
RC2012F1402CS	(2012, ±1%, 14Kohm, E-96)	Marking = 1402
RC2012F1R0CS	(2012, ±1%, 1ohm, E-96)	Marking = 1R0
- Exceptions are as follows.
  - 1) D- and F-grades of over 1608 size shall be marked with 3-digit numbers same as E-24 Series if it can be marked.
  - 2) Some vendors (companies), are allowed to mark other R-value different from ours.

## Temperature Coefficient of Resistance : TCR

- TCR (Temperature Coefficient of Resistance) represents the change rate (drift) of R-value per 1°C within the range of working temperature based on 20°C temperature. And it is the characteristic to check a status of changes in R-value according to changes in temperature.
- It is based on R-value measured at 20°C, and TCR at this point is zero.
- The measurement formula and the graph are as follows.

$$T.C.R(ppm / ^\circ C) = \left( \frac{R_2 - R_1}{R_1} \right) \times \left( \frac{1}{t_2 - t_1} \right) \times 10^6$$

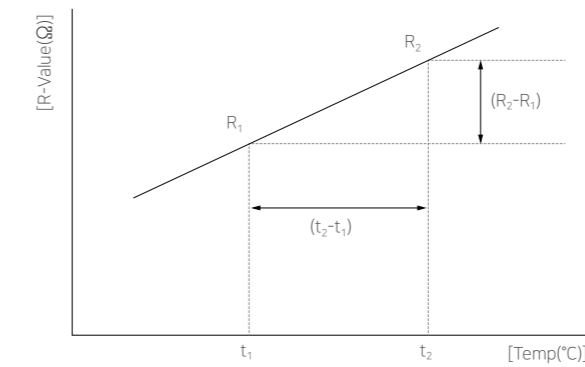

## Insulation resistance

- Insulation R measures the resistance between an electrode and a ceramic body, and R-value must be over 1,000MΩ. During the measurement, DC voltage shall be applied for 1 minute and any mechanical damages must not be followed.

## Dielectric withstanding Voltage

- Insulation R measures the resistance between an electrode and an insulation layer, and R-value must be over 1,000MΩ. During the measurement, DC voltage shall be applied for 1 minute and any mechanical damages must not be followed.

- General\_Standard Standard(RC)
- General\_Standard Reverse(RCB)
- Array Type Resistor Flat(RF, RM)
- Array Type Resistor Concave(RN, RM, RK)
- Array Type Resistor Convex(RP)
- Current Sensing Resistor Low ohms(RUT)
- Current Sensing Resistor Ultra Low ohms(RU, RUK)
- Current Sensing Resistor Wide Terminal(RJ)
- Metal\_CSR Metal Plate\_Clad(RLP,RLC)
- High Power Resistor General(RCW)
- High Voltage Chip Resistor (RCV)
- Anti-Sulfur Resistor General, Array(RCS, RFS, RPS)
- Lead free Chip Resistor General, Array, AntiSulfur
- Center Common Array 3-Terminal Array(RFT)
- Characteristics Performance
- Packaging
- Standard Resistance Value
- Electrical & Mechanical Caution
- Process of Mounting Soldering, Design
- Caution of Application

# Product Characteristic data Notes

\* Under development

Type	Size (inch)/(mm)	Element (mm x n)	Feature	Watt (W)	Max Working Voltage	Tolerance (%)	R Value		Head of P/N				RoHS	AEC-Q200
							Min	Max	General	Anti-Sulfur		Reverse		
										Pb Free				
Discrete	01005 (0402)	0402 x 1R		1/32	15	±1.0 ±2.0 ±5.0	1Ω	1MΩ	RC	RCS	RH			●
	0201 (0603)	0603 x 1R		1/20	25	±1.0 ±2.0 ±5.0	1Ω	10MΩ	RC	RCS RCWS RCVS	RH	RCB		●
	0402 (1005)	1005 x 1R		1/20	100	±1.0 ±2.0 ±5.0	1Ω	10MΩ	RC	RCS RCWS RCVS	RH	RCB		●
	0603 (1608)	1608 x 1R		1/10	50	±1.0 ±2.0 ±5.0	1Ω	10MΩ	RC	RCS RCWS RCVS	RH	RCB		●
	0805 (2012)	2012 x 1R		1/8	150	±1.0 ±2.0 ±5.0	1Ω	10MΩ	RC	RCS RCWS RCVS	RH			●
	1206 (3216)	3216 x 1R		1/4	200	±1.0 ±2.0 ±5.0	1Ω	10MΩ	RC	RCS RCWS RCVS	RH			●
	1210 (3225)	3225 x 1R		1/3	200	±1.0 ±2.0 ±5.0	1Ω	10MΩ	RC	RCS RCWS RCVS	RH			●
	2010 (5025)	5025 x 1R		2/3	200	±1.0 ±2.0 ±5.0	1Ω	10MΩ	RC					●
	2512 (6432)	6432 x 1R		1	200	±1.0 ±2.0 ±5.0	1Ω	10MΩ	RC					●
	0201 Array	0603 x 2R, 4R (Flat)		1/32	12.5	±1.0 ±2.0 ±5.0	10Ω	1MΩ	RF	RFS		RM		●
Array	0402 Array	1005 x 2R, 4R (Convex)		1/16	25	±1.0 ±2.0 ±5.0	10Ω	1MΩ	RP	RPS				●
	0402 Revers Array	1005 x 2R, 4R (Concave)		1/16	25	±1.0 ±2.0 ±5.0	10Ω	1MΩ	RM	RK				●

\* Under development

Type	Size (inch)/(mm)	Watt (W)	R-Value(mΩ)	Rated current [A]	TOL. (%)	T.C.R. ppm/°C	Operational Temp. (°C)	Pb Free	RoHS	AEC-Q200										
											RLE Series E-Beam Welded	*3920	10050	Max	±1.0	100	-65~-175	●	●	●
												*2512	6432	Max	±1.0	100	-65~-175	●	●	●
RL Series Face up	2512	6432	Max	±1.0	75	-65~-170	●	●	●											
	*1206	3216	5	±1.0	75~100	-55~-170	●	●	●											
	*0805	2012	5	±1.0	75~150	-65~-170	●	●	●											
	*0508	1220	1	±1.0	100	-65~-170	●	●	●											
RUK Series Face Down Low T.C.R	*0603	1608	5	±1.0	150	-55~-155	●	●	●											
	2512	6432	30	±1.0	100~500	-55~-155	●	●	●											
	1206	3216	30	±1.0	100	-55~-155	●	●	●											
	0805	2012	30	±1.0	100~250	-55~-155	●	●	●											
RJ Series Face Down Wide Termination	0603	1608	30	±1.0	100	-55~-155	●	●	●											
	0815	2037	20	±1.0	100	-55~-155	●	●	●											
	0612	1632	20	±1.0	100~200	-55~-155	●	●	●											
	0508	1220	20	±1.0	200	-55~-155	●	●	●											
RU Series Face Down	*0306	0816	20	±1.0	200	-55~-155	●	●	●											
	2512	6432	100	±1.0	150~500	-55~-155	●	●	●											
	2010	5025	100	±1.0	150~500	-55~-155	●	●	●											
	1210	3225	100	±1.0	150~500	-55~-155	●	●	●											
	1206	3216	100	±1.0	150~500	-55~-155	●	●	●											
	0805	2012	100	±1.0	150~600	-55~-155	●	●	●											
RUT Series Face Down General CSR	0603	1608	100	±1.0	150~600	-55~-155	●	●	●											
	0402	1005	100	±1.0	150~500	-55~-155	●	●	●											
	2512	6432	976	±1.0	100	-55~-155	●	●	●											
	2010	5025	976	±1.0	100	-55~-155	●	●	●											
	1210	3225	976	±1.0	100	-55~-155	●	●	●											
	1206	3216	976	±1.0	100	-55~-155	●	●	●											

Product Characteristic data Notes

- General\_Standard Standard(RC)
- General\_Standard Reverse(RCB)
- Array Type Resistor Flat(RF, RM)
- Array Type Resistor Concave(RN, RM, RK)
- Array Type Resistor Convex(RP)
- Current Sensing Resistor Low ohms(RUT)
- Current Sensing Resistor Ultra Low ohms(RU, RUK)
- Current Sensing Resistor Wide Terminal(RJ)
- Meta\_CSR Metal Plate\_Clad(RLP, RLC)
- High Power Resistor General(RCW)
- High Voltage Chip Resistor (RCV)
- Anti-Sulfur Resistor General, Array(RCS, RFS, RPS)
- Lead free Chip Resistor General, Array, AntiSulfur
- Center Common Array 3-Terminal Array(RFT)
- Characteristics Performance
- Packaging
- Standard Resistance Value
- Electrical & Mechanical Caution
- Process of Mounting Soldering, Design
- Caution of Application

# General\_Standard

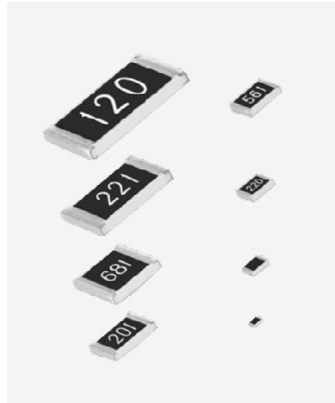

## Features

- Very small, thin, and light weight.
- Both flow and reflow soldering are applicable.
- Very low inductance.
- Suitable size and packaging for surface mount assembly
- Lead-free terminal.
- EU RoHS Compliant.
- AEC-Q200 Compliant.

## Application

- General purpose.
- Home Appliances. (DVD, Digital TV, Digital Camera, Audio, Tunner).
- For Computers & Communications. (Notebook, Memory Module, Mobile, Network Equipment, etc).

## Structure and Dimensions

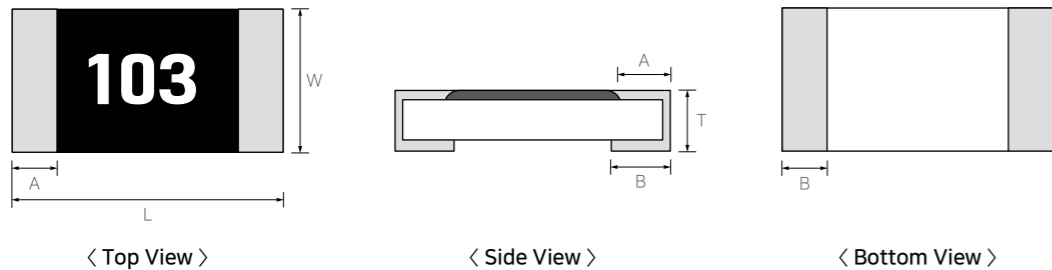

(Unit: mm)

Type	Size(inch)	L	W	T	A	B
RC0402	01005	0.40 ± 0.02	0.20 ± 0.02	0.13 ± 0.02	0.10 ± 0.03	0.10 ± 0.03
RC0603	0201	0.60 ± 0.03	0.30 ± 0.03	0.23 ± 0.03	0.10 ± 0.05	0.15 ± 0.05
RC1005	0402	1.00 ± 0.05	0.50 ± 0.05	0.35 ± 0.05	0.20 ± 0.10	0.25 ± 0.10
RC1608	0603	1.60 ± 0.10	0.80 ± 0.10	0.45 ± 0.10	0.30 ± 0.20	0.35 ± 0.10
RC2012	0805	2.00 ± 0.20	1.25 ± 0.15	0.55 ± 0.10	0.40 ± 0.20	0.35 ± 0.20
RC3216	1206	3.20 ± 0.20	1.60 ± 0.15	0.55 ± 0.10	0.45 ± 0.20	0.40 ± 0.20
RC3225	1210	3.20 ± 0.20	2.55 ± 0.20	0.55 ± 0.10	0.45 ± 0.20	0.40 ± 0.20
RC5025	2010	5.00 ± 0.20	2.50 ± 0.20	0.55 ± 0.10	0.60 ± 0.20	0.60 ± 0.20
RC6432	2512	6.30 ± 0.20	3.20 ± 0.20	0.55 ± 0.10	0.60 ± 0.20	0.60 ± 0.20

\*0402(inch) and smaller size don't have marking on top the chips.  
\*0603(inch) 4-digit models(E-96 series) don't have marking on top of the chips.

## Parts Numbering System

- The part number system shall be in the following format

RC	2012	J	100	CS
Code Designation	Dimension & Size Code	Tolerance	Resistance Value	Packaging Code
RC : Chip Resistor	0402 : 0.4×0.2(mm)-01005(inch) 0603 : 0.6×0.3(mm)-0201(inch) 1005 : 1.0×0.5(mm)-0402(inch) 1608 : 1.6×0.8(mm)-0603(inch) 2012 : 2.0×1.2(mm)-0805(inch) 3216 : 3.2×1.6(mm)-1206(inch) 3225 : 3.2×2.5(mm)-1210(inch) 5025 : 5.0×2.5(mm)-2010(inch) 6432 : 6.4×3.2(mm)-2512(inch)	D : ±0.5% F : ±1% G : ±2% J : ±5%  *Jumper : J	3 or 4 digits coding system (IEC coding system) 3digits (E-24 series) 4digits (E-96 series)  *Jumper : '000'	CS : Tape Packaging 7" ES : Tape Packaging 10" AS : Tape Packaging 13"

## Specification

Type	Size (inch)	Rated Power (W)	Rated Voltage (V)	Max Working Voltage (V)	Tolerance (%)	Resistance Range (Ω)	T.C.R (ppm/°C)	Working Temp. (°C)	Rated Ambient Temp. (°C)	Moisture Level		
RC0402	01005	1/32	$\sqrt{P \times R}$ P: Rated Power(W) R: Resistance(Ω)	15	±1(F) ±2(G) ±5(J)	1~99 100~1M 10~10M	±300 ±250 ±300 ±250	-55~125	70	Level 1		
RC0603	0201	1/20		25								
RC1005	0402	1/16		50								
RC1608	0603	1/10		50	±0.5(D) ±1(F) ±2(G) ±5(J)	1~9.9 10~10M	±300 ±100	-55~155				
RC2012	0805	1/8		150								
RC3216	1206	1/4		200								
RC3225	1210	1/3		200								
RC5025	2010	2/3		200	200							
RC6432	2512	1		200	200							

- Please contact our sales representatives or engineers for other specifications

## Power Derating Curve

- The rated power is the maximum continuous loading power at 70°C ambient temperature. For ambient temperature above 70°C, the loading power follows the below power derating curve.

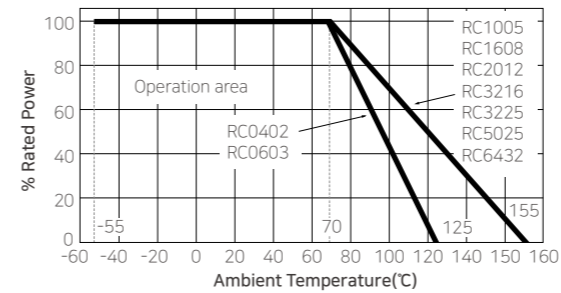

## Jumper Rating

Type	Size (inch)	Rated Current (A)	Resistance (Ω)
RC0402	01005	0.5	0.05 Max
RC0603	0201		
RC1005	0402	1.0	
RC1608	0603		
RC2012	0805	2.0	
RC3216	1206		
RC3225	1210		
RC5025	2010		
RC6432	2512		

## IEC Code System (E-96, E-24)

E-96	E-24	E-96	E-24	E-96	E-24	E-96	E-24
100	10	178		316		562	56
102		182	18	324	33	576	
105		187		332		590	
107		191		340		604	
110	11	196		348		619	
113		200	20	357	36	634	62
115		205		365		649	
118		210		374		665	
121	12	215		383	39	681	68
124		221	22	392		698	
127		226		402		715	
130	13	232		412		732	
133		237		422		750	75
137		243	24	432	43	768	
140		249		442		787	
143		255		453		806	
147		261		464		825	82
150	15	267		475	47	845	
154		274	27	487		866	
158		280		499		887	
162	16	287		511	51	909	
165		294		523		931	91
169		301	30	536		963	
174		309		549		976	

## Marking

3 digits indication (E-24 series)	4 digits indication (E-96 series)
- Left 2 digits represent significant figures. - Last 1 digit represents exponential number of 10. - Example: 103 Left 2 digits: 10 Left 1 digit: 3 $103 = 10 \times 10^3 \Omega$ $= 10000 \Omega = 10k\Omega$	- Left 3 digits represent significant figures. - Last 1 digit represents exponential number of 10. - Example: 1002 Left 2 digits: 100 Left 1 digit: 2 $1002 = 100 \times 10^2 \Omega$ $= 10000 \Omega = 10k\Omega$
No marking types : RC0402, RC0603, RC1005	No marking types : RC0402, RC0603, RC1005, RC1608

The specifications and designs contained herein may be subject to change without notice. Please contact our sales representatives or product engineers before order.

# Reverse General



## Features

- Resistor is on the bottom side (more stable for the outer impacts)
- Lead-free terminal
- Specially designed for Memory Modules
- EU RoHS Compliant.
- AEC-Q200 Compliant.

## Application

- General purpose.
- Home Appliances.(DVD, Digital TV, Digital Camera, Audio, Tunner).
- For Computers & Communications.(Notebook, Menory Module, Mobile, Network Equipment, etc).

## Structure and Dimensions

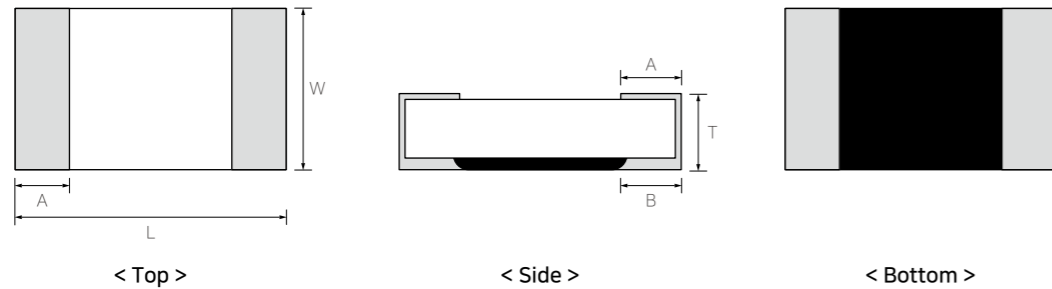

(Unit: mm)

Type	Size(inch)	L	W	T	A	B
RCB0603	0201	0.60 ± 0.03	0.30 ± 0.03	0.23 ± 0.03	0.15 ± 0.05	0.15 ± 0.05
RCB1005	0402	1.00 ± 0.05	0.50 ± 0.05	0.35 ± 0.05	0.25 ± 0.10	0.25 ± 0.10

## Parts Numbering System

- The part number system shall be in the following format

RCB	0603	J	100	CS
Code Designation	Dimension & Size Code	Tolerance	Resistance Value	Packaging Code
RCB : Reverse Chip Resistor	0603 : 0.6×0.3(mm)-0201(inch) 1005 : 1.0×0.5(mm)-0402(inch)	D : ±0.5% F : ±1% G : ±2% J : ±5%  *Jumper : J	3 or 4 digits coding system (IEC coding system) 3digits (E-24 series) 4digits (E-96 series)  *Jumper : '000'	CS : Tape Packaging 7" ES : Tape Packaging 10" AS : Tape Packaging 13"

## Specification

Type	Size (inch)	Rated Power (W)	Rated Voltage (V)	Max Working Voltage (V)	Tolerance (%)	Resistance Range (Ω)	T.C.R (ppm/°C)	Working Temp. (°C)	Rated Ambient Temp. (°C)	Moisture Level
RCB0603	0201	1/20	$\sqrt{P \times R}$	25	±1(F) ±5(J)	1~9.9 10~10M	±300 ±250	-55~125	70	Level 1
RCB1005	0402	1/16	P : Rated Power(W) R : Resistance(Ω)	50		1~9.9 10~10M	±300 ±100	-55~155		

- Please contact our sales representatives or engineers for other specifications

## Power Derating Curve

- The rated power is the maximum continuous loading power at 70°C ambient temperature. For ambient temperature above 70°C, the loading power follows the below power derating curve.

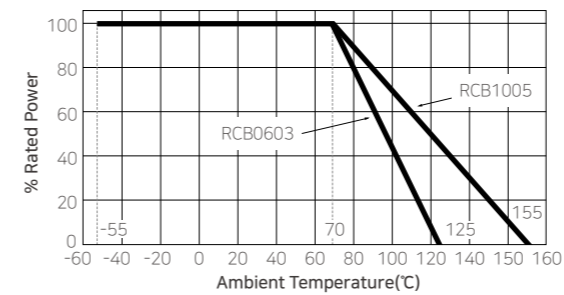

## Jumper Rating

Type	Size (inch)	Rated Current (A)	Resistance (Ω)
RCB0603	0201	0.5	0.05 Max
RCB1005	0402	1.0	

## Marking

3 digits indication (E-24 series)	4 digits indication (E-96 series)
- Left 2 digits represent significant figures. - Last 1 digit represents exponential number of 10. - Example: <b>103</b> Left 2 digits: 10 Left 1 digit: 3 $103 = 10 \times 10^3 \Omega = 10000 \Omega = 10k\Omega$	- Left 3 digits represent significant figures. - Last 1 digit represents exponential number of 10. - Example: <b>1002</b> Left 2 digits: 100 Left 1 digit: 2 $1002 = 100 \times 10^2 \Omega = 10000 \Omega = 10k\Omega$
No marking types : RCB0603, RCB1005	No marking types : RCB0603, RCB1005

## IEC Code System (E-96, E-24)

E-96	E-24	E-96	E-24	E-96	E-24	E-96	E-24
100	10	178		316		562	56
102		182	18	324	33	576	
105		187		332		590	
107		191		340		604	
110	11	196		348		619	
113		200	20	357	36	634	62
115		205		365		649	
118		210		374		665	
121	12	215		383	39	681	68
124		221	22	392		698	
127		226		402		715	
130	13	232		412		732	
133		237		422		750	75
137		243	24	432	43	768	
140		249		442		787	
143		255		453		806	
147		261		464		825	
150	15	267		475	47	845	82
154		274	27	487		866	
158		280		499		887	
162	16	287		511	51	909	
165		294		523		931	91
169		301	30	536		963	
174		309		549		976	

The specifications and designs contained herein may be subject to change without notice. Please contact our sales representatives or product engineers before order.

# Arrays(Flat Type)

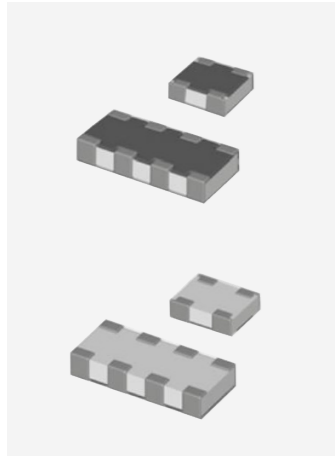

### Features

- 2 or 4 isolated resistors are in a body.
- Small size array
- Lead-free terminal
- Specially designed for Memory Modules
- EU RoHS Compliant.
- AEC-Q200 Compliant.

### Application

- For semiconductor devices.
- For computers, digital circuits.

## Structure and Dimensions

### (1) Flat Type Array

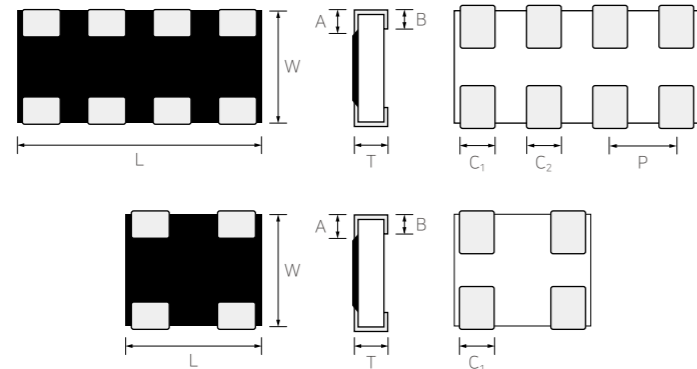

(Unit: mm)

Type	L	W	T	A	B	C <sub>1</sub>	C <sub>2</sub>	P
RF062P	0.80 ± 0.05	0.60 ± 0.05	0.23 ± 0.10	0.15 ± 0.10	0.20 ± 0.10	0.25 ± 0.10	-	0.50 ± 0.10
RF064P	1.40 ± 0.05	0.60 ± 0.05	0.23 ± 0.10	0.15 ± 0.10	0.20 ± 0.10	0.25 ± 0.10	0.25 ± 0.10	0.40 ± 0.10

### (2) Inverted Type Array

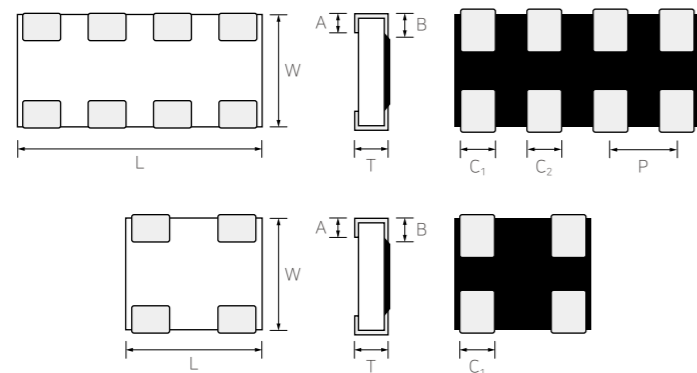

(Unit: mm)

Type	L	W	T	A	B	C <sub>1</sub>	C <sub>2</sub>	P
RM062P	0.80 ± 0.05	0.60 ± 0.05	0.23 ± 0.10	0.15 ± 0.10	0.20 ± 0.10	0.20 ± 0.10	-	0.50 ± 0.10
RM064P	1.40 ± 0.05	0.60 ± 0.05	0.23 ± 0.10	0.15 ± 0.10	0.20 ± 0.10	0.20 ± 0.10	0.20 ± 0.10	0.40 ± 0.10

## Parts Numbering System

- The part number system shall be in the following format

RF	6	4P	J	150	CS
Code Designation	Dimension	Resistors	Tolerance	Resistance Value	Packaging Code
RF : Flat RM : Inverted & Flat	06 : 0201 Array	2P : 2 Pieces 4P : 4 Pieces	J : ±5% *Jumper : J	3 digits coding system (IEC coding system) E-24 series *Jumper : '000'	CS : Tape Packaging 7" ES : Tape Packaging 10" AS : Tape Packaging 13"

## Specification

Type	Size (inch)	Rated Power (W)	Rated Voltage (V)	Max Working Voltage (V)	Tolerance (%)	Resistance Range (Ω)	T.C.R (ppm/°C)	Working Temp. (°C)	Rated Ambient Temp. (°C)	Moisture Level
062P	0302	1/32	$\sqrt{P \times R}$	12.5	±5(J)	10~1M	±200	-55~125	70	Level 1
064P	0502	1/32	P : Rated Power(W) R : Resistance(Ω)	12.5						

- Please contact our sales representatives or engineers for other specifications

## Power Derating Curve

- The rated power is the maximum continuous loading power at 70°C ambient temperature. For ambient temperature above 70°C, the loading power follows the below power derating curve.

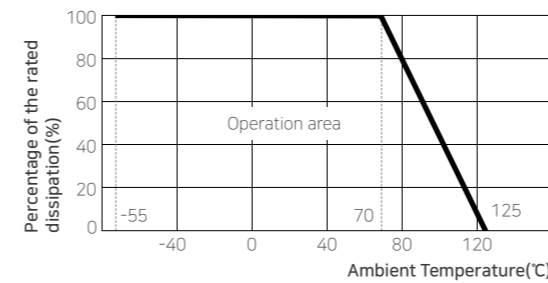

## Jumper Rating

Type	Size (inch)	Rated Current (A)	Resistance (Ω)
062P	302	0.5	0.05 Max
064P	502		

## Land Pattern

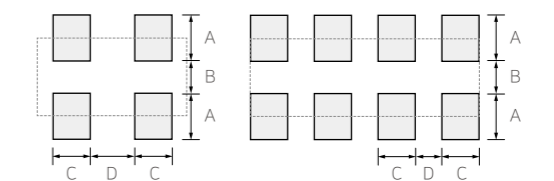

■ : Land Pattern  
□ : Chip Resistor

Type (inch)	Reflow Soldering				
Dimension	A	B	2A+B	C	D
062P	0.3	0.3	0.9	0.2	0.3
064P	0.3	0.3	0.9	0.2	0.2

The specifications and designs contained herein may be subject to change without notice. Please contact our sales representatives or product engineers before order.

Product Characteristic data Notes

General\_Standard Standard(RC)

General\_Standard Reverse(RCB)

Array Type Resistor Flat(RF, RM)

Array Type Resistor Concave(RN, RM, RK)

Array Type Resistor Convex(RP)

Current Sensing Resistor Low ohms(RUT)

Current Sensing Resistor Ultra Low ohms(RU, RUK)

Current Sensing Resistor Wide Terminal(RJ)

Metal\_CSR Metal Plate\_Clad(RLP,RLC)

High Power Resistor General(RCW)

High Voltage Chip Resistor (RCV)

Anti-Sulfur Resistor General, Array(RCS, RFS, RPS)

Lead free Chip Resistor General, Array, AntiSulfur

Center Common Array 3-Terminal Array(RFT)

Characteristics Performance

Packaging

Standard Resistance Value

Electrical & Mechanical Caution

Process of Mounting Soldering, Design

Caution of Application

# Arrays(Concave Type)

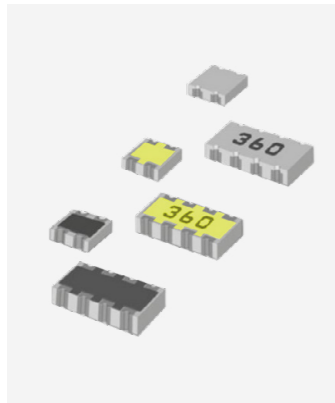

### Features

- 2 or 4 isolated resistors are in a body.
- Strong body
- Lead-free terminal
- Specially designed for Memory Modules
- EU RoHS Compliant.
- AEC-Q200 Compliant.

### Application

- For semiconductor devices.
- For computers, digital circuits.

### Structure and Dimensions

#### (1) Concave Type

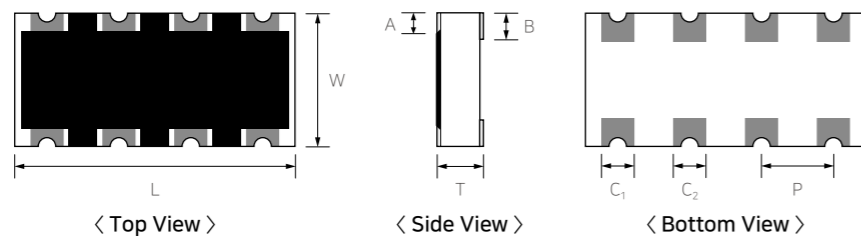

(Unit: mm)

Type	L	W	T	A	B	C <sub>1</sub>	C <sub>2</sub>	P
RN102P	1.00 ± 0.10	1.00 ± 0.10	0.35 ± 0.10	0.15 ± 0.10	0.25 ± 0.15	0.33 ± 0.10	-	0.50 ± 0.10
RN104P	2.00 ± 0.10	1.00 ± 0.10	0.40 ± 0.10	0.15 ± 0.10	0.25 ± 0.15	0.30 ± 0.10	0.30 ± 0.10	0.50 ± 0.10

#### (2) Inverted Concave Type

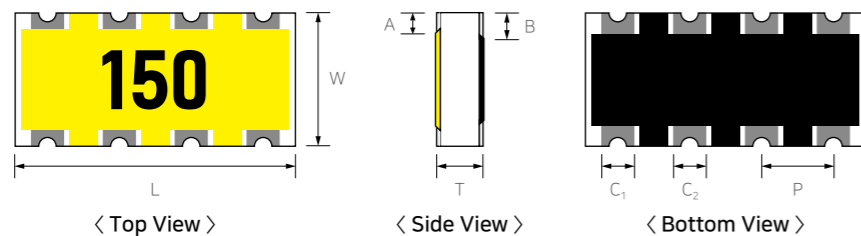

(Unit: mm)

Type	L	W	T	A	B	C <sub>1</sub>	C <sub>2</sub>	P
RM102P	1.00 ± 0.10	1.00 ± 0.10	0.35 ± 0.10	0.15 ± 0.10	0.25 ± 0.15	0.33 ± 0.10	-	0.50 ± 0.10
RM104P	2.00 ± 0.10	1.00 ± 0.10	0.45 ± 0.10	0.15 ± 0.10	0.25 ± 0.15	0.30 ± 0.10	0.30 ± 0.10	0.50 ± 0.10

#### (3) Short-free & Inverted Concave Type

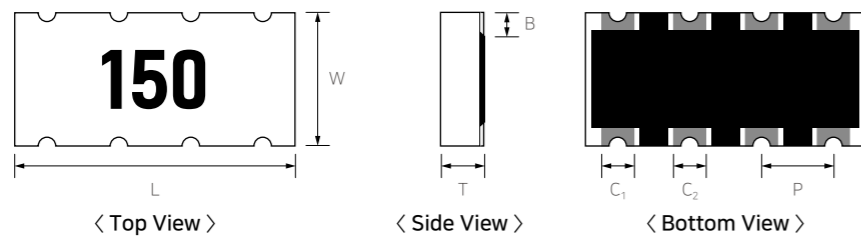

(Unit: mm)

Type	L	W	T	A	B	C <sub>1</sub>	C <sub>2</sub>	P
RK102P	1.00 ± 0.10	1.00 ± 0.10	0.35 ± 0.10	-	0.25 ± 0.15	0.33 ± 0.10	-	0.50 ± 0.10
RK104P	2.00 ± 0.10	1.00 ± 0.10	0.45 ± 0.10	-	0.25 ± 0.15	0.30 ± 0.10	0.30 ± 0.10	0.50 ± 0.10

### Parts Numbering System

■ The part number system shall be in the following format

RN	10	4P	J	100	CS
Code Designation	Dimension	Resistors	Tolerance	Resistance Value	Packaging Code
RN : Concave RM : Inverted Concave RK : Short-free & Inverted	10 : 0402 Array	2P : 2 Pieces 4P : 4 Pieces	F : ±1% J : ±5% *Jumper : J	3 digits coding system (IEC coding system) E-24 series *Jumper : '000'	CS : Tape Packaging 7" ES : Tape Packaging 10" AS : Tape Packaging 13"

### Specification

Type	Size (inch)	Rated Power (W)	Rated Voltage (V)	Max Working Voltage (V)	Tolerance (%)	Resistance Range (Ω)	T.C.R (ppm/°C)	Working Temp. (°C)	Rated Ambient Temp. (°C)	Moisture Level
102P	0404	1/16	$\sqrt{P \times R}$	25	±1(F) ±2(G) ±5(J)	1~9.9 10~1M	±300 ±200	-55~155	70	Level 1
104P	0804	1/16	P : Rated Power(W) R : Resistance(Ω)	25						

■ Please contact our sales representatives or engineers for other specifications

### Power Derating Curve

■ The rated power is the maximum continuous loading power at 70°C ambient temperature. For ambient temperature above 70°C, the loading power follows the below power derating curve.

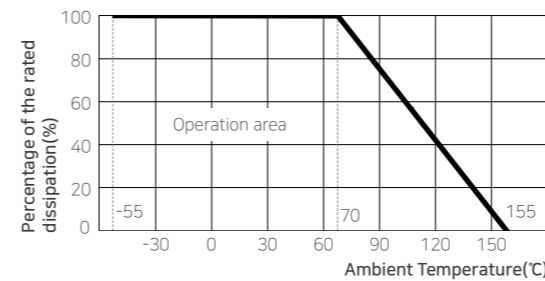

### Jumper Rating

Type	Size (inch)	Rated Current (A)	Resistance (Ω)
102P	0404	1.0	0.05 Max
104P	0804		

### Land Pattern

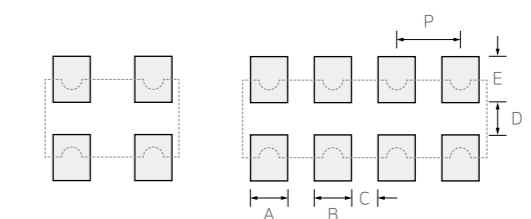

■ : Land Pattern  
□ : Chip Resistor

Type	A	B	C	D	E	P
102P	0.3	-	0.2	0.5	0.4	0.5
104P	0.3	0.3	0.2	0.5	0.4	0.5

Product Characteristic data Notes

General\_Standard Standard(RC)

General\_Standard Reverse(RCB)

Array Type Resistor Flat(RF, RM)

Array Type Resistor Concave(RN, RM, RK)

Array Type Resistor Convex(RP)

Current Sensing Resistor Low ohms(RUT)

Current Sensing Resistor Ultra Low ohms(RU, RUK)

Current Sensing Resistor Wide Terminal(RJ)

Metal\_CSR Metal Plate\_Clad(RLP, RLC)

High Power Resistor General(RCW)

High Voltage Chip Resistor (RCV)

Anti-Sulfur Resistor General, Array(RCS, RFS, RPS)

Lead free Chip Resistor General, Array, AntiSulfur

Center Common Array 3-Terminal Array(RFT)

Characteristics Performance

Packaging

Standard Resistance Value

Electrical & Mechanical Caution

Process of Mounting Soldering, Design

Caution of Application

The specifications and designs contained herein may be subject to change without notice. Please contact our sales representatives or product engineers before order.

# Arrays(Convex Type)

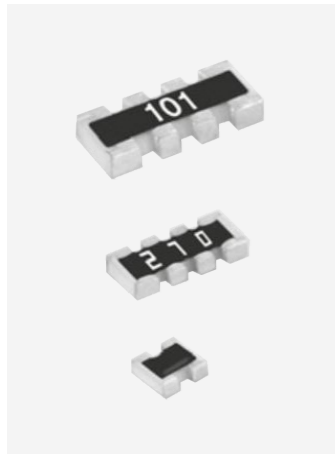

### Features

- General type resistor array
- 2 or 4 isolated resistors are in a body.
- Lead-free terminal
- EU RoHS Compliant.
- AEC-Q200 Compliant.

### Application

- For semiconductor devices.
- For computers, digital circuits.

### Structure and Dimensions

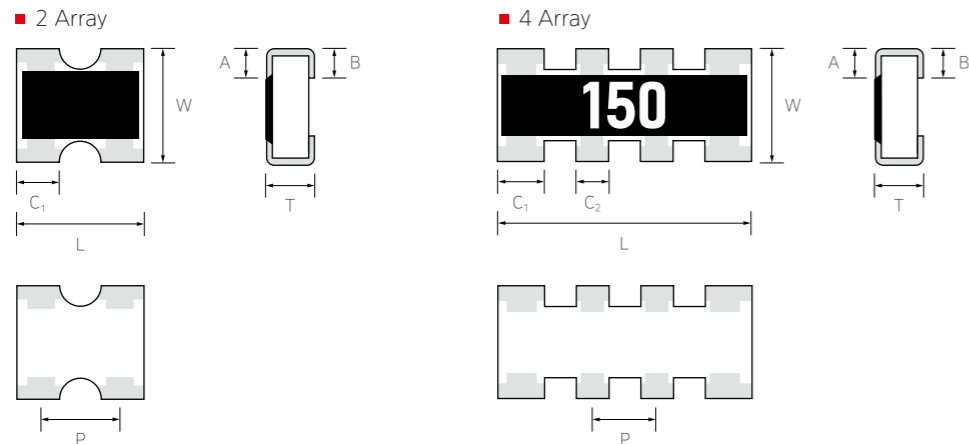

Type	L	W	T	A	B	C <sub>1</sub>	C <sub>2</sub>	P
RP102P	1.00 ± 0.10	1.00 ± 0.10	0.35 ± 0.10	0.20 ± 0.10	0.25 ± 0.10	0.33 ± 0.10	-	0.65 ± 0.10
RP104P	2.00 ± 0.10	1.00 ± 0.10	0.35 ± 0.10	0.20 ± 0.10	0.25 ± 0.10	0.40 ± 0.10	0.30 ± 0.10	0.50 ± 0.10

### Parts Numbering System

- The part number system shall be in the following format

RP	10	4P	J	100	CS
Code Designation	Dimension	Resistors	Tolerance	Resistance Value	Packaging Code
RP : Convex	10 : 0402 Array 16 : 0603 Array	2P : 2 Pieces 4P : 4 Pieces	J : ±5% *Jumper : J	3 digits coding system (IEC coding system) E-24 series *Jumper : '000'	CS : Tape Packaging 7" ES : Tape Packaging 10" AS : Tape Packaging 13"

### Specification

Type	Size (inch)	Rated Power (W)	Rated Voltage (V)	Max Working Voltage (V)	Tolerance (%)	Resistance Range (Ω)	T.C.R (ppm/°C)	Working Temp. (°C)	Rated Ambient Temp. (°C)	Moisture Level
RP102P	0404	1/16	$\sqrt{P \times R}$	25	±5(J)	1~9.9	±300	-55~155	70	Level 1
RP104P	0804	1/16	P : Rated Power(W) R : Resistance(Ω)	25		10~1M	±200			

- Please contact our sales representatives or engineers for other specifications

### Power Derating Curve

- The rated power is the maximum continuous loading power at 70°C ambient temperature. For ambient temperature above 70°C, the loading power follows the below power derating curve.

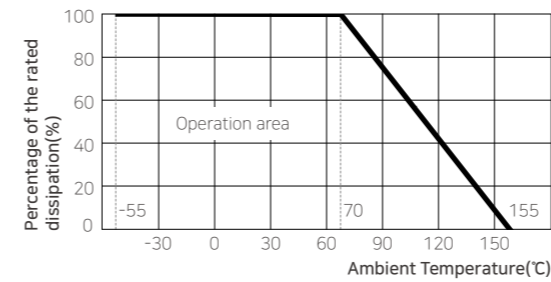

### Jumper Rating

Type	Size (inch)	Rated Current (A)	Resistance (Ω)
RP102P	0404	1.0	0.05 Max
RP104P	0804		

### Land Pattern

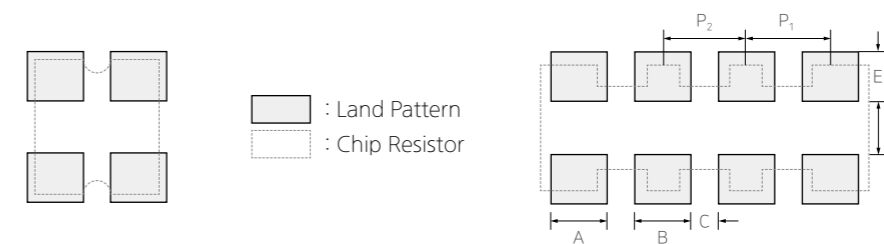

Type	A	B	C	D	E	P <sub>1</sub>	P <sub>2</sub>
RP102P	0.4	-	0.25	0.5	0.5	0.65	
RP104P	0.5	0.3	0.2	0.5	0.5	0.55	0.5

The specifications and designs contained herein may be subject to change without notice. Please contact our sales representatives or product engineers before order.

Product Characteristic data Notes

General\_Standard Standard(RC)

General\_Standard Reverse(RCB)

Array Type Resistor Flat(RF, RM)

Array Type Resistor Concave(RN, RM, RK)

#### Array Type Resistor Convex(RP)

Current Sensing Resistor Low ohms(RUT)

Current Sensing Resistor Ultra Low ohms(RU, RUK)

Current Sensing Resistor Wide Terminal(RJ)

Metal\_CSR Metal Plate\_Clad(RLP, RLC)

High Power Resistor General(RCW)

High Voltage Chip Resistor (RCV)

Anti-Sulfur Resistor General, Array(RCS, RFS, RPS)

Lead free Chip Resistor General, Array, AntiSulfur

Center Common Array 3-Terminal Array(RFT)

Characteristics Performance

Packaging

Standard Resistance Value

Electrical & Mechanical Caution

Process of Mounting Soldering, Design

Caution of Application

# Low Ohms(RUT Series)

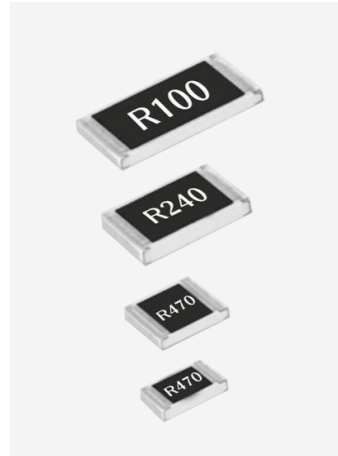

## Features

- Mid range thick film type low ohm resistors
- Resistance range in 0.1~1Ω
- Resistor is on top surface
- Totally lead-free product
- EU RoHS Compliant.
- AEC-Q200 Compliant.

## Application

- Lighting modules
- PCM of Battery Pack
- Power supplying part, DC power Charger, adapter.
- Mobile Phone, HDD, DSC, LCD

## Structure and Dimensions

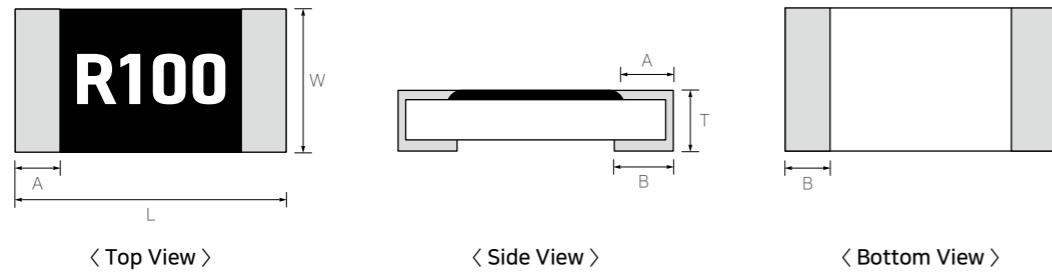

(Unit: mm)

Type	Size(inch)	L	W	T	A	B
RUT1005	0402	1.00 ± 0.05	0.50 ± 0.05	0.35 ± 0.05	0.20 ± 0.10	0.25 ± 0.10
RUT1608	0603	1.60 ± 0.10	0.80 ± 0.10	0.45 ± 0.10	0.30 ± 0.20	0.35 ± 0.10
RUT2012	0805	2.00 ± 0.20	1.25 ± 0.15	0.55 ± 0.10	0.40 ± 0.20	0.35 ± 0.20
RUT3216	1206	3.20 ± 0.20	1.60 ± 0.15	0.55 ± 0.10	0.45 ± 0.20	0.40 ± 0.20
RUT3225	1210	3.20 ± 0.20	2.55 ± 0.20	0.55 ± 0.10	0.45 ± 0.20	0.40 ± 0.20
RUT5025	2010	5.00 ± 0.20	2.50 ± 0.20	0.55 ± 0.10	0.60 ± 0.20	0.60 ± 0.20
RUT6432	2512	6.30 ± 0.20	3.20 ± 0.20	0.55 ± 0.10	0.60 ± 0.20	0.60 ± 0.20

## Parts Numbering System

- The part number system shall be in the following format

RUT	2012	J	100	CS
Code Designation	Dimension & Size Code	Tolerance	Resistance Value	Packaging Code
RUT : Current Sensing Resistor	1005 : 1.0×0.5(mm)-0402(inch) 1608 : 1.6×0.8(mm)-0603(inch) 2012 : 2.0×1.2(mm)-0805(inch) 3216 : 3.2×1.6(mm)-1206(inch) 3225 : 3.2×2.5(mm)-1210(inch) 5025 : 5.0×2.5(mm)-2010(inch) 6432 : 6.4×3.2(mm)-2512(inch)	F : ±1% G : ±2% J : ±5%	4-digit coding system	CS : Tape & Reel 7" ES : Tape & Reel 10" AS : Tape & Reel 13"

## Specification

Type	Size (inch)	Rated Power (W)	Resistance (Ω)	T.C.R (ppm/°C)	Rated Current (A)	Rated Ambient Temperature (°C)	Working Temperature (°C)
RUT1005	0402	1/8	0.1~0.976	±100	$\sqrt{P/R}$ P: Rated Power(W) R: Resistance(Ω)	70	-55~155
RUT1608	0603	1/4					
RUT2012	0805	1/3					
RUT3216	1206	1/2					
RUT3225	1210	2/3					
RUT5025	2010	3/4					
RUT6432	2512	1					

- Please contact our sales representatives or engineers for other specifications

## Power Derating Curve

- The rated power is the maximum continuous loading power at 70°C ambient temperature. For ambient temperature above 70°C, the loading power follows the below power derating curve.

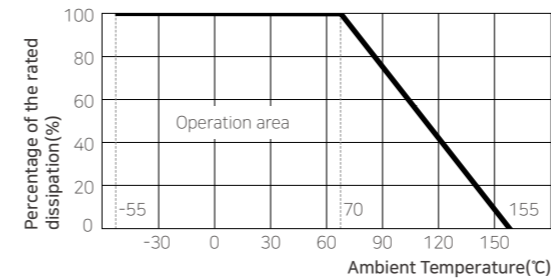

## Marking

### 4 digits indication

- R means decimal point.
- Other digits represent the significant value.
- Example: R100  
R100 = .100 = 0.100Ω  
= 0.1Ω or 100mΩ



## Resistance Value Table

Code	Value (Ω)	Tol (%)	Code	Value (Ω)	Tol (%)	Code	Value (Ω)	Tol (%)	Code	Value (Ω)	Tol (%)	Code	Value (Ω)	Tol (%)	Code	Value (Ω)	Tol (%)
R100	0.1	±1, ±5	R154	0.154	±1	R226	0.226	±1	R330	0.33	±1, ±5	R470	0.47	±1, ±5	R680	0.68	±1, ±5
R102	0.102	±1	R158	0.158	±1	R232	0.232	±1	R332	0.332	±1	R475	0.475	±1	R681	0.681	±1
R105	0.105	±1	R160	0.16	±1, ±5	R237	0.237	±1	R340	0.34	±1	R487	0.487	±1	R698	0.698	±1
R107	0.107	±1	R162	0.162	±1	R240	0.24	±1, ±5	R348	0.348	±1	R499	0.499	±1	R715	0.715	±1
R110	0.11	±1, ±5	R165	0.165	±1	R243	0.243	±1	R357	0.357	±1	R510	0.51	±1, ±5	R732	0.732	±1
R113	0.113	±1	R169	0.169	±1	R249	0.49	±1	R360	0.36	±1, ±5	R511	0.511	±1	R750	0.75	±1, ±5
R115	0.115	±1	R174	0.174	±1	R255	0.255	±1	R365	0.365	±1	R523	0.523	±1	R768	0.768	±1
R118	0.118	±1	R178	0.178	±1	R261	0.261	±1	R374	0.374	±1	R536	0.536	±1	R787	0.787	±1
R120	0.12	±1, ±5	R180	0.18	±1, ±5	R267	0.267	±1	R383	0.383	±1	R549	0.549	±1	R806	0.806	±1
R121	0.121	±1	R182	0.182	±1	R270	0.27	±1, ±5	R390	0.39	±1, ±5	R560	0.56	±1, ±5	R820	0.82	±1, ±5
R124	0.124	±1	R187	0.187	±1	R274	0.274	±1	R392	0.392	±1	R562	0.562	±1	R825	0.825	±1
R127	0.127	±1	R191	0.191	±1	R280	0.28	±1	R402	0.402	±1	R576	0.576	±1	R845	0.845	±1
R130	0.13	±1, ±5	R196	0.196	±1	R287	0.287	±1	R412	0.412	±1	R590	0.59	±1	R866	0.866	±1
R133	0.133	±1	R200	0.200	±1, ±5	R294	0.294	±1	R422	0.422	±1	R604	0.604	±1	R887	0.887	±1
R137	0.137	±1	R205	0.205	±1	R300	0.300	±1, ±5	R430	0.43	±1, ±5	R619	0.619	±1	R909	0.909	±1
R140	0.14	±1	R210	0.21	±1	R301	0.301	±1	R432	0.432	±1	R620	0.62	±1, ±5	R910	0.91	±1, ±5
R143	0.143	±1	R215	0.215	±1	R309	0.309	±1	R442	0.442	±1	R634	0.634	±1	R931	0.931	±1
R147	0.147	±1	R220	0.22	±1, ±5	R316	0.316	±1	R453	0.453	±1	R649	0.649	±1	R953	0.953	±1
R150	0.15	±1, ±5	R221	0.221	±1	R324	0.324	±1	R464	0.464	±1	R665	0.665	±1	R976	0.976	±1

The specifications and designs contained herein may be subject to change without notice. Please contact our sales representatives or product engineers before order.

Product Characteristic data Notes

General\_Standard Standard(RC)

General\_Standard Reverse(RCB)

Array Type Resistor Flat(RF, RM)

Array Type Resistor Concave(RN, RM, RK)

Array Type Resistor Convex(RP)

## Current Sensing Resistor Low ohms(RUT)

Current Sensing Resistor Ultra Low ohms(RU, RUK)

Current Sensing Resistor Wide Terminal(RJ)

Metal\_CSR Metal Plate\_Clad(RLP, RLC)

High Power Resistor General(RCW)

High Voltage Chip Resistor (RCV)

Anti-Sulfur Resistor General, Array(RCS, RFS, RPS)

Lead free Chip Resistor General, Array, AntiSulfur

Center Common Array 3-Terminal Array(RFT)

Characteristics Performance

Packaging

Standard Resistance Value

Electrical & Mechanical Caution

Process of Mounting Soldering, Design

Caution of Application

# Ultra Low Ohms(RU Series)

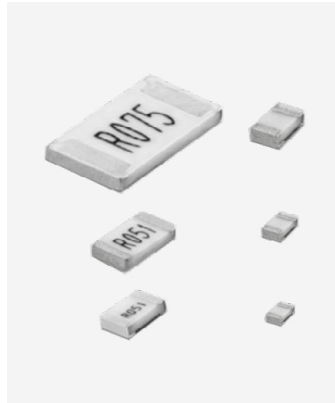

## Features

- Thick film type low ohm resistors
- Resistance range in 0.01~0.1Ω
- Resistor is on bottom surface
- Totally lead-free product
- EU RoHS Compliant.
- AEC-Q200 Compliant.

## Application

- Current Sensing.
- PCM of Battery Pack.
- Power supplying part, DC power charger, Adapter.
- Mobile Phone, Mobile PC, Note PC, HDD, DSC, LCD

## Structure and Dimensions

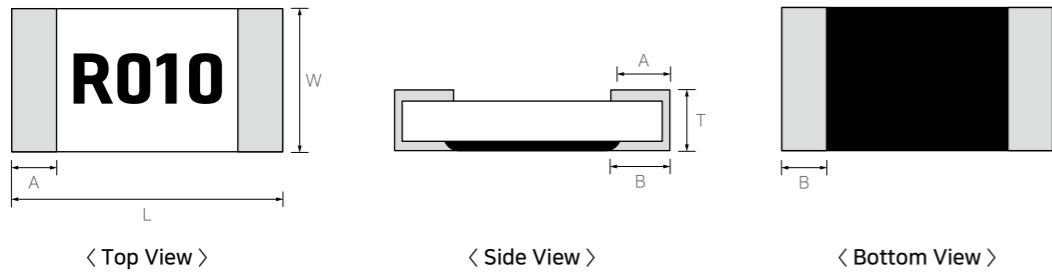

(Unit: mm)

Type	Size(inch)	L	W	T	A	B
RU1005	0402	1.00 ± 0.05	0.50 ± 0.05	0.35 ± 0.05	0.25 ± 0.15	0.25 ± 0.15
RU1608	0603	1.60 ± 0.10	0.80 ± 0.10	0.45 ± 0.10	0.30 ± 0.20	R≤0.05:0.50±0.20 R≥0.05:0.35±0.20
RU2012	0805	2.00 ± 0.20	1.25 ± 0.15	0.55 ± 0.10	0.40 ± 0.20	R≤0.05:0.65±0.20 R≥0.05:0.40±0.20
RU3216	1206	3.20 ± 0.20	1.60 ± 0.15	0.60 ± 0.10	0.45 ± 0.20	R≤0.05:0.90±0.20 R≥0.05:0.60±0.20
RU3225	1210	3.20 ± 0.20	2.55 ± 0.20	0.60 ± 0.10	0.45 ± 0.20	R≤0.05:1.70±0.20 R≥0.05:0.75±0.20
RU5025	2010	5.00 ± 0.20	2.50 ± 0.20	0.60 ± 0.10	0.50 ± 0.20	R≤0.05:1.50±0.20 R≥0.05:0.90±0.20
RU6432	2512	6.30 ± 0.20	3.20 ± 0.20	0.60 ± 0.10	0.50 ± 0.20	R≤0.05:1.90±0.20 R≥0.05:1.10±0.25

## Parts Numbering System

- The part number system shall be in the following format

RU	2012	F	R051	CS
Code Designation	Dimension & Size Code	Tolerance	Resistance Value	Packaging Code
RU : Current Sensing Resistor	1005 : 1.0×0.5(mm)-0402(inch) 1608 : 1.6×0.8(mm)-0603(inch) 2012 : 2.0×1.2(mm)-0805(inch) 3216 : 3.2×1.6(mm)-1206(inch) 3225 : 3.2×2.5(mm)-1210(inch) 5025 : 5.0×2.5(mm)-2010(inch) 6432 : 6.4×3.2(mm)-2512(inch)	F : ±1% G : ±2% J : ±5%	4-digit coding system	CS : Tape & Reel 7" ES : Tape & Reel 10" AS : Tape & Reel 13"

## Specification

Type	Size (inch)	Rated Power (W)	Resistance (Ω)	T.C.R (ppm/°C)	Rated Current (A)	Rated Ambient Temperature (°C)	Working Temperature (°C)
RU1005	0402	1/8	0.02~0.1	R < 0.047 : ±500 R ≥ 0.047 : ±150	$\sqrt{P/R}$ P: Rated Power(W) R: Resistance(Ω)	70	-55~+155
RU1608	0603	1/4	0.01~0.1	R < 0.025 : ±600 R < 0.033 : ±400 R ≥ 0.033 : ±150			
RU2012	0805	1/3					
RU3216	1206	1/2					
RU3225	1210	2/3					
RU5025	2010	3/4					
RU6432	2512	1					

- Please contact our sales representatives or engineers for other specifications

## Power Derating Curve

- The rated power is the maximum continuous loading power at 70°C ambient temperature. For ambient temperature above 70°C, the loading power follows the below power derating curve.

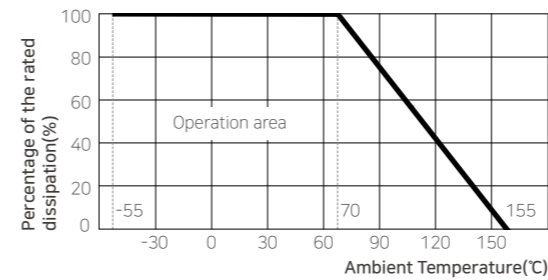

## Marking

### 4-digits indication

- R means decimal point.
- Other digits represent the significant value.
- No marking applied for the 0603(inch) and smaller sizes
- Example: R010  
R010 = .010 = 0.010Ω  
= 0.01Ω or 10mΩ



## Resistance Value Table

Code	Value (Ω)	Tol (%)	Code	Value (Ω)	Tol (%)	Code	Value (Ω)	Tol (%)	Code	Value (Ω)	Tol (%)
R010	0.010	±1, ±5	R020	0.020	±1, ±5	R039	0.039	±1, ±5	R062	0.062	±1, ±5
R011	0.011	±1, ±5	R022	0.022	±1, ±5	R040	0.040	±1, ±5	R068	0.068	±1, ±5
R012	0.012	±1, ±5	R024	0.024	±1, ±5	R043	0.430	±1, ±5	R075	0.075	±1, ±5
R013	0.013	±1, ±5	R027	0.027	±1, ±5	R047	0.047	±1, ±5	R082	0.082	±1, ±5
R015	0.015	±1, ±5	R030	0.030	±1, ±5	R050	0.050	±1, ±5	R091	0.091	±1, ±5
R016	0.016	±1, ±5	R033	0.033	±1, ±5	R051	0.051	±1, ±5	R100	0.100	±1, ±5
R018	0.018	±1, ±5	R036	0.036	±1, ±5	R056	0.056	±1, ±5			

## Land Pattern Standard

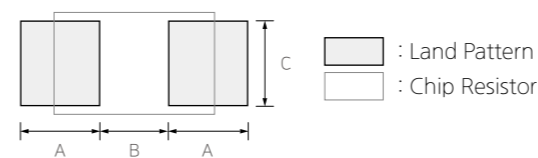

Type	A	B	2A+B	C
RU1005	0.8	0.5	2.1	0.5
RU1608	0.8	0.5	2.1	0.8
RU2012	0.9	0.8	2.6	1.2
RU3216	1.7	1.2	4.6	1.4
RU3225	1.7	1.2	4.6	2.4
RU5025	2.15	1.8	6.1	2.6
RU6432	2.3	3.0	7.6	3.3

The specifications and designs contained herein may be subject to change without notice. Please contact our sales representatives or product engineers before order.

Product Characteristic data Notes

General\_Standard Standard(RC)

General\_Standard Reverse(RCB)

Array Type Resistor Flat(RF, RM)

Array Type Resistor Concave(RN, RM, RK)

Array Type Resistor Convex(RP)

Current Sensing Resistor Low ohms(RUT)

Current Sensing Resistor Ultra Low ohms(RU, RUK)

Current Sensing Resistor Wide Terminal(RJ)

Metal\_CSR Metal Plate\_Clad(RLP, RLC)

High Power Resistor General(RCW)

High Voltage Chip Resistor (RCV)

Anti-Sulfur Resistor General, Array(RCS, RFS, RPS)

Lead free Chip Resistor General, Array, AntiSulfur

Center Common Array 3-Terminal Array(RFT)

Characteristics Performance

Packaging

Standard Resistance Value

Electrical & Mechanical Caution

Process of Mounting Soldering, Design

Caution of Application

# Ultra Low Ohms(RUK Series)

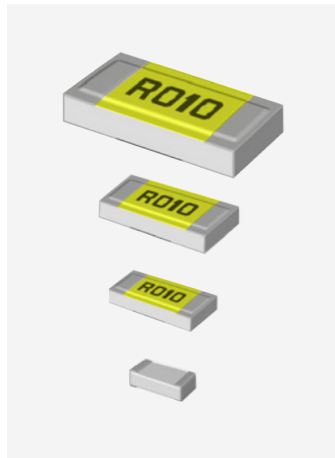

## Features

- Thick film type low ohm resistors
- Low TCR and High Power
- Resistance range in 0.01~0.03Ω
- Resistor is on bottom surface
- Totally lead-free product
- EU RoHS Compliant.
- AEC-Q200 Compliant.

## Application

- Current Sensing.
- PCM of Battery Pack.
- Power supplying part, DC power charger, Adapter.
- Mobile Phone, Mobile PC, Note PC, HDD, DSC, LCD.

## Structure and Dimensions

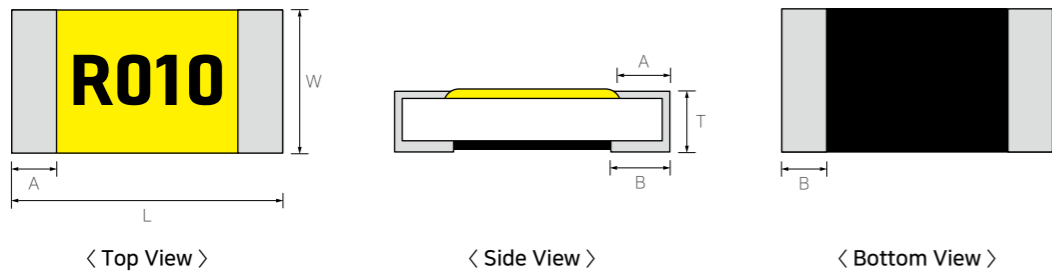

(Unit: mm)

Type	Size(inch)	L	W	T	A	B
RUK1608	0603	1.60 ± 0.10	0.80 ± 0.10	R < 15m:0.55±0.10 R ≥ 15m:0.45±0.10	0.35 ± 0.20	0.40 ± 0.20
RUK2012	0805	2.00 ± 0.20	1.25 ± 0.15	R < 15m:0.60±0.10 R ≥ 15m:0.55±0.10	0.40 ± 0.20	0.55 ± 0.20
RUK3216	1206	3.20 ± 0.20	1.60 ± 0.15	R < 15m:0.65±0.10 R ≥ 15m:0.60±0.10	0.45 ± 0.20	0.90 ± 0.20
RUK6432	2512	6.30 ± 0.20	3.20 ± 0.20	R < 15m:0.65±0.10 R ≥ 15m:0.60±0.10	1.15 ± 0.20	0.90 ± 0.20

## Parts Numbering System

- The part number system shall be in the following format

RUK	1608	F	R010	CS
Code Designation	Dimension & Size Code	Tolerance	Resistance Value	Packaging Code

RUK : Curren Sensing Resistor Low TCR	1608 : 1.6×0.8(mm)-0603(inch) 2012 : 2.0×1.2(mm)-0805(inch) 3216 : 3.2×1.6(mm)-1206(inch) 6432 : 6.4×3.2(mm)-2512(inch)	F : ±1% G : ±2% J : ±5%	4-digit coding system	CS : Tape & Reel 7" ES : Tape & Reel 10" AS : Tape & Reel 13"
---------------------------------------	--	-------------------------------	-----------------------	---

## Specification

Type	Size (inch)	Rated Power (W)	Resistance (Ω)	T.C.R (ppm/°C)	Rated Current (A)	Rated Ambient Temperature (°C)	Working Temperature (°C)
RUK1608	0603	1/2	0.010~0.030	±100	$\sqrt{P/R}$ P: Rated Power(W) R: Resistance(Ω)	70	-55~+155
RUK2012	0805	1/2	0.007~0.009 0.010~0.030	±250 ±100			
RUK3216	1206	1	0.010~0.030	±100			
RUK6432	2512	1	0.007~0.009 0.010~0.030	±500 ±100			

- Please contact our sales representatives or engineers for other specifications

## Power Derating Curve

- The rated power is the maximum continuous loading power at 70°C ambient temperature. For ambient temperature above 70°C, the loading power follows the below power derating curve.

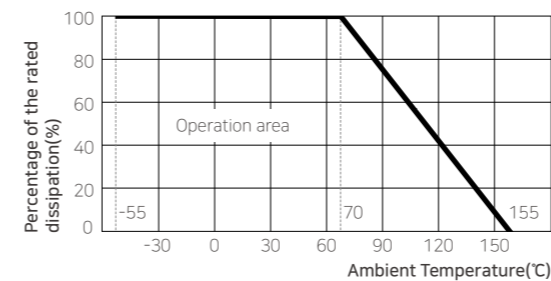

## Marking

### 4-digits indication

- R means decimal point.
- Other digits represent significant value.
- No marking applied for the 0603(inch) and smaller sizes
- Example:R010  
R010= .010=0.010Ω  
=0.01Ω or 10mΩ



## Resistance Value Table

Code	Value (Ω)	Tol (%)	Code	Value (Ω)	Tol (%)
R010	0.010	±1, ±5	R018	0.018	±1, ±5
R011	0.011	±1, ±5	R020	0.020	±1, ±5
R012	0.012	±1, ±5	R022	0.022	±1, ±5
R013	0.013	±1, ±5	R024	0.024	±1, ±5
R015	0.015	±1, ±5	R027	0.027	±1, ±5
R016	0.016	±1, ±5	R030	0.030	±1, ±5

## Land Pattern Standard

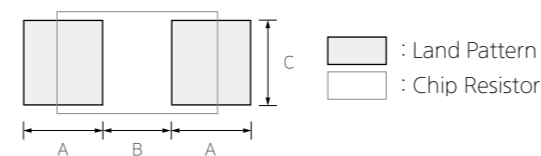

Type	A	B	2A+B	C
RUK1608	0.8	0.5	2.1	0.8
RUK2012	0.9	0.8	2.6	1.2
RUK3216	1.7	1.2	4.6	1.4
RUK6432	2.3	3.0	7.6	3.3

The specifications and designs contained herein may be subject to change without notice. Please contact our sales representatives or product engineers before order.

Product Characteristic data Notes

General\_Standard Standard(RC)

General\_Standard Reverse(RCB)

Array Type Resistor Flat(RF, RM)

Array Type Resistor Concave(RN, RM, RK)

Array Type Resistor Convex(RP)

Current Sensing Resistor Low ohms(RUT)

Current Sensing Resistor Ultra Low ohms(RU, RUK)

Current Sensing Resistor Wide Terminal(RJ)

Metal\_CSR Metal Plate\_Clad(RLP,RLC)

High Power Resistor General(RCW)

High Voltage Chip Resistor (RCV)

Anti-Sulfur Resistor General, Array(RCS, RFS, RPS)

Lead free Chip Resistor General, Array, AntiSulfur

Center Common Array 3-Terminal Array(RFT)

Characteristics Performance

Packaging

Standard Resistance Value

Electrical & Mechanical Caution

Process of Mounting Soldering, Design

Caution of Application

# Wide Terminal(RJ Series)

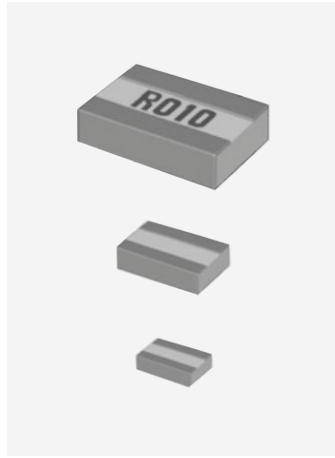

## Features

- Thick film type wide terminal low ohm resistors
- High Power
- Resistance range in 0.002~0.02Ω
- Resistor is on bottom surface
- Totally lead-free product
- EU RoHS Compliant.
- AEC-Q200 Compliant.

## Application

- Current Sensing.
- PCM of Battery Pack.
- DC Power Charger, Adapter.
- Mobile Phone, Mobile PC, HDD, DSC, LCD.

## Structure and Dimensions

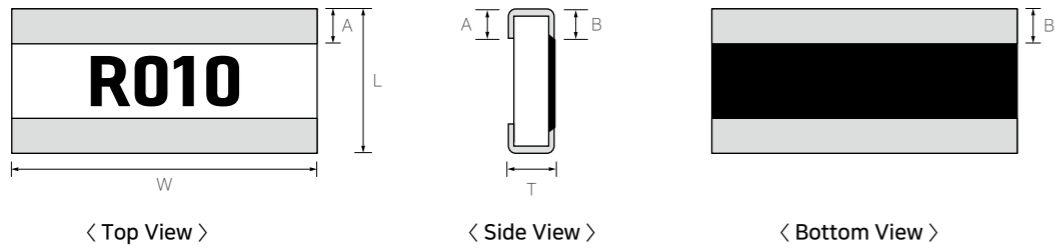

(Unit: mm)

Type	Size(inch)	L	W	T	A	B
*RJ0816	0306	0.80 ± 0.10	1.60 ± 0.10	0.45 ± 0.15	0.25 ± 0.15	0.30 ± 0.15
RJ1220	0508	1.25 ± 0.10	2.00 ± 0.10	0.55 ± 0.15	0.30 ± 0.15	0.35 ± 0.15
RJ1632	0612	1.60 ± 0.15	3.20 ± 0.15	0.55 ± 0.15	0.35 ± 0.20	0.40 ± 0.20
RJ2037	0815	2.00 ± 0.15	3.75 ± 0.15	0.55 ± 0.15	0.45 ± 0.20	0.55 ± 0.20
*RJ3264	1225	3.20 ± 0.20	6.40 ± 0.20	0.55 ± 0.15	0.60 ± 0.20	0.60 ± 0.20

\* Under development

## Parts Numbering System

- The part number system shall be in the following format

RJ	816	F	R010	CS
Code Designation	Dimension & Size Code	Tolerance	Resistance Value	Packaging Code
RJ : Thick Film Wide Terminal CSR	0816 : 0.8×1.6(mm) - 0306(inch) 1220 : 1.2×2.0(mm) - 0508(inch) 1632 : 1.6×3.2(mm) - 0612(inch) 2037 : 2.0×3.7(mm) - 0815(inch) 3264 : 3.2×6.4(mm) - 1225(inch)	F : ±1% G : ±2% J : ±5%	4-digit coding system	CS : Tape & Reel 7" ES : Tape & Reel 10" AS : Tape & Reel 13"

## Specification

Type	Size (inch)	Rated Power (W)	Resistance (Ω)	T.C.R (ppm/°C)	Rated Current (A)	Rated Ambient Temperature (°C)	Working Temperature (°C)
*RJ0816	0306	1/2	0.005~0.02	±200	$\sqrt{P/R}$ P: Rated Power(W) R: Resistance(Ω)	70	-55~155
RJ1220	0508	1	0.002~0.02	±150			
RJ1632	0612	1	0.005~0.02	±100			
RJ2037	0815	1	0.005~0.02	±100			
*RJ3264	1225	2	0.005~0.02	±100			

- Please contact our sales representatives or engineers for other specifications

## Power Derating Curve

- The rated power is the maximum continuous loading power at 70°C ambient temperature. For ambient temperature above 70°C, the loading power follows the below power derating curve.

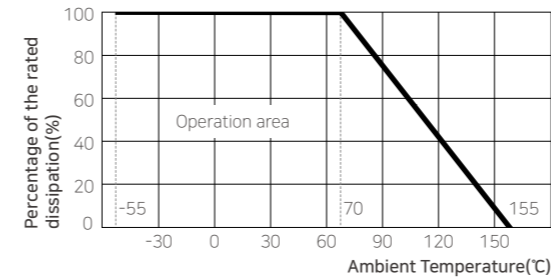

## Marking

### 4-digits indication

- R means decimal point.
- Other digits represent significant value.
- No marking applied for the 0508(inch) and smaller sizes
- Example: R010  
R010 = .010 = 0.010Ω  
= 0.01Ω or 10mΩ



## Resistance Value Table

Code	Value (Ω)	Tol (%)	Code	Value (Ω)	Tol (%)	Code	Value (Ω)	Tol (%)
R005	0.005	±1, ±5	R013	0.013	±1, ±5	R030	0.030	±1, ±5
R006	0.006	±1, ±5	R015	0.015	±1, ±5	R033	0.033	±1, ±5
R007	0.007	±1, ±5	R016	0.016	±1, ±5	R036	0.036	±1, ±5
R008	0.008	±1, ±5	R018	0.018	±1, ±5	R039	0.039	±1, ±5
R009	0.009	±1, ±5	R020	0.020	±1, ±5	R040	0.040	±1, ±5
R010	0.010	±1, ±5	R022	0.022	±1, ±5	R043	0.043	±1, ±5
R011	0.011	±1, ±5	R024	0.024	±1, ±5	R047	0.047	±1, ±5
R012	0.012	±1, ±5	R027	0.027	±1, ±5	R050	0.050	±1, ±5

## Land Pattern Standard

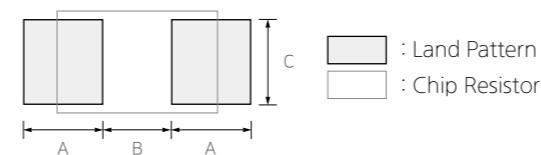

Type	A	B	2A+B	C
*RJ0816	0.5	0.3	1.3	1.6
RJ1220	0.7	0.4	1.8	2.0
RJ1632	1.1	0.6	2.8	3.3
RJ2037	1.4	1.2	4.0	3.8
*RJ3264	2.0	1.6	5.6	6.5

The specifications and designs contained herein may be subject to change without notice. Please contact our sales representatives or product engineers before order.

Product Characteristic data Notes

General\_Standard Standard(RC)

General\_Standard Reverse(RCB)

Array Type Resistor Flat(RF, RM)

Array Type Resistor Concave(RN, RM, RK)

Array Type Resistor Convex(RP)

Current Sensing Resistor Low ohms(RUT)

Current Sensing Resistor Ultra Low ohms(RU, RUK)

Current Sensing Resistor Wide Terminal(RJ)

Metal\_CSR Metal Plate\_Clad(RLP, RLC)

High Power Resistor General(RCW)

High Voltage Chip Resistor (RCV)

Anti-Sulfur Resistor General, Array(RCS, RFS, RPS)

Lead free Chip Resistor General, Array, AntiSulfur

Center Common Array 3-Terminal Array(RFT)

Characteristics Performance

Packaging

Standard Resistance Value

Electrical & Mechanical Caution

Process of Mounting Soldering, Design

Caution of Application

# Metal\_CSR (RLP & RLC Series)



## Features

- Metal Plate Type Ultra Low Ohm Resistor.
- High Power with Very Low T.C.R.
- 100% Lead Free Products.
- EU RoHS Compliant.
- AEC-Q200 Compliant.

## Application

- Current Sensing
- PCM of Battery Pack
- Power Supplying Parts, DC Charger, Adapter
- Mobile PC, Note PC, HDD, DSC, LCD

## Structure and Dimensions

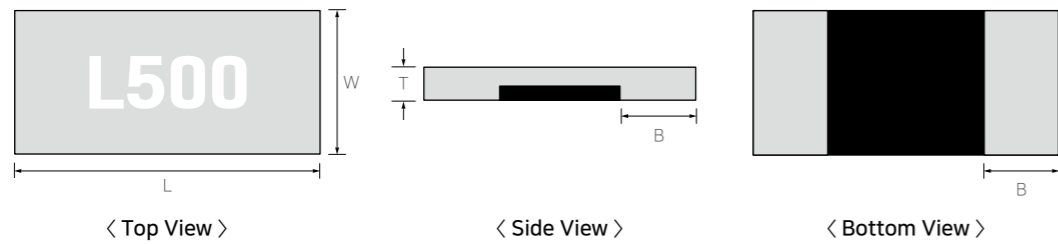

(Unit: mm)

Type	Resistance	L	W	T	**B
*RLP1608	1~5mΩ	1.60 ± 0.15	0.80 ± 0.15	0.45 ± 0.15	1~5mΩ : 0.45 ± 0.15
*RJP1220	0.5~2mΩ	1.25 ± 0.20	2.00 ± 0.20	0.45 ± 0.15	0.5~2mΩ : 0.35 ± 0.15
*RLP2012	1~5mΩ	2.00 ± 0.20	1.20 ± 0.20	0.45 ± 0.15	1~5mΩ : 0.45 ± 0.15
*RLP3216	1~5mΩ	3.20 ± 0.20	1.60 ± 0.20	0.45 ± 0.20	1mΩ : 1.00±0.20 2~5mΩ : 0.80±0.20
RLC6432 RLP6432	0.5~5mΩ	6.35 ± 0.25	3.20 ± 0.25	0.60 ± 0.25	0.5mΩ : 2.40±0.25 1mΩ : 2.21±0.25 2~5mΩ : 1.45±0.25

\* Under development  
\*\* Termination width B can be modified after the discussion.

## Parts Numbering System

- The part number system shall be in the following format

RLP	E	6432	F	L500	CS
Code Designation	Rated Power	Dimension & Size Code	Tolerance	Resistance	Packaging code
RLC : without top coating RLP : with top coating RJP : wide terminal	D : 0.5W E : 1.0W F : 2.0W G : 3.0W	6432 : 6.4x3.2(mm)	F : ±1% J : ±5%	4-Digit Code - R : Decimal for ohm - L : Decimal for mohm	CS : 7" reel

## Specification

Type	Size (inch)	Rated Power (W)	Resistance (Ω)	T.C.R (ppm/°C)	Rated Current (A)	Rated Ambient Temperature (°C)	Working Temperature (°C)
*RLP1608	1608 (0603)	1	1~5m	±150	$\sqrt{P/R}$ P : Rated Power(W) R : Resistance(Ω)	70	-55~155
*RJP1220	1220 (0508)	1	0.5~2m	±100			
*RLP2012	2012 (0805)	1	1~5m	±100~±75			-55~170
*RLP3216	3216 (1206)	1	1~5m	±100~±75			
RLC6432	6432 (2512)	1~3	0.5m	±75			
RLP6432	(2512)	1~2	1~5m				

- Please contact our sales representatives or engineers for other specifications

## Power Derating Curve

- The rated power is the maximum continuous loading power at 70°C ambient temperature. For ambient temperature above 70°C, the loading power follows the below power derating curve.

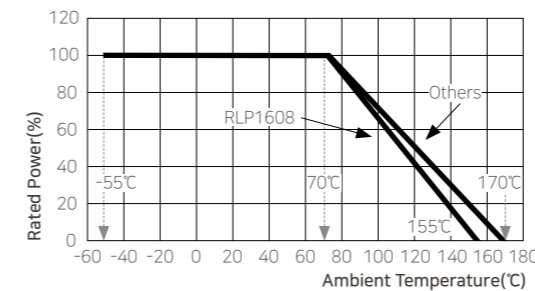

## Resistance Code

### 4-Digit Coding System

- "R" means decimal point for ohm
- "L" means decimal point for mohm

Code	Value (mΩ)	Tol. (%)
L500	0.5	±1, ±5
R001	1	±1, ±5
R002	2	±1, ±5
R003	3	±1, ±5
R004	4	±1, ±5
R005	5	±1, ±5

## Land Pattern Standard

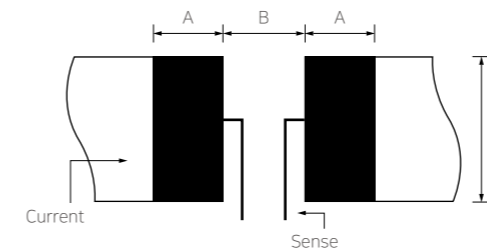

※ Reflow soldering only suggested

Size	R Value (mΩ)	A	B	C
*1608	1~5	0.80	0.50	1.00
*1220	0.5~1	0.75	0.40	2.20
*2012	1~5	1.10	0.80	1.40
*3216	1 2~5	1.80 1.60	1.00 1.40	1.80
6432	0.5~4	3.05	1.27	3.68
	5	2.11	3.18	3.68

## Characteristics Performance

Item	Specification	Test Method
Short Time Over Load	±0.5%	5 times of rated power for 5 s
Temperature Cycle	±0.5%	1,000 cycle, -55~150 °C, 15 min dwell time (-55~125°C for 1608)
High Temperature Exposure	±1.0%	1,000hr at Maximum operating temperature
Load Life	±1.0%	1,000hr at 70°C applied rated power
Biased humidity	±0.5%	1,000hr at 85°C / 85% RH applied 10% of rated power

The specifications and designs contained herein may be subject to change without notice. Please contact our sales representatives or product engineers before order.

Product Characteristic data Notes

General\_Standard Standard(RC)

General\_Standard Reverse(RCB)

Array Type Resistor Flat(RF, RM)

Array Type Resistor Concave(RN, RM, RK)

Array Type Resistor Convex(RP)

Current Sensing Resistor Low ohms(RUT)

Current Sensing Resistor Ultra Low ohms(RU, RUK)

Current Sensing Resistor Wide Terminal(RJ)

**Metal\_CSR Metal Plate\_Clad(RLP,RLC)**

High Power Resistor General(RCW)

High Voltage Chip Resistor (RCV)

Anti-Sulfur Resistor General, Array(RCS, RFS, RPS)

Lead free Chip Resistor General, Array, AntiSulfur

Center Common Array 3-Terminal Array(RFT)

Characteristics Performance

Packaging

Standard Resistance Value

Electrical & Mechanical Caution

Process of Mounting Soldering, Design

Caution of Application

# High Power Chip Resistor

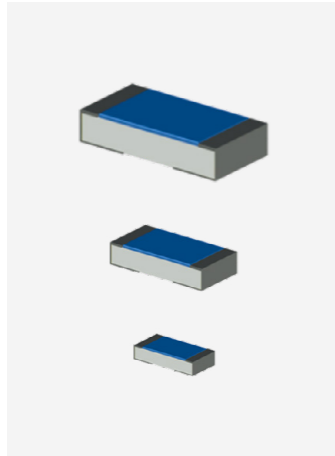

## Features

- Thick film type High-Power Resistor
- Higher Working Voltage with Anti-Surge and Anti-Pulse.
- Applicable Both flow and reflow soldering.
- Suitable size and package for surface mount assembly.
- RoHS Compliant.
- AEC-Q200 Compliant

## Application

- General purpose, Downsizing
- High Power, High Voltage
- Anti-Pulse, Anti-Surge(ESD)

## Structure, Dimensions and Specification

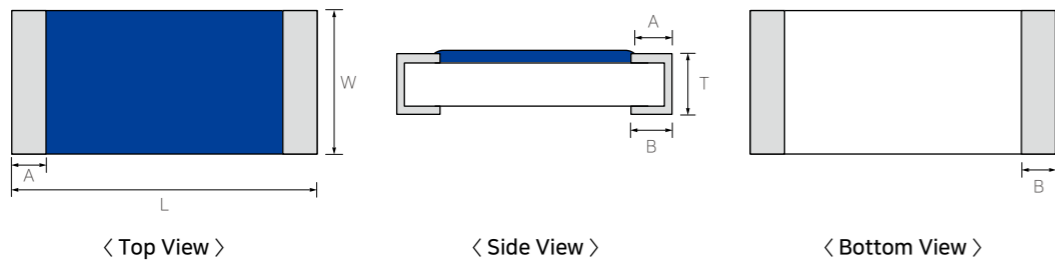

(Unit: mm)

Type	L	W	T	A	B	Weight (mg/K)
RCW0603	0.60 ± 0.03	0.30 ± 0.03	0.23 ± 0.03	0.10 ± 0.05	0.15 ± 0.05	0.15mg
RCW1005	1.00 ± 0.05	0.50 ± 0.05	0.35 ± 0.05	0.20 ± 0.10	0.25 ± 0.10	0.6mg
RCW1608	1.60 ± 0.10	0.80 ± 0.10	0.45 ± 0.10	0.35 ± 0.15	0.35 ± 0.15	2.1mg
*RCW2012	2.00 ± 0.20	1.25 ± 0.15	0.55 ± 0.10	0.30 ± 0.20	0.35 ± 0.20	4.9mg
*RCW3216	3.20 ± 0.20	1.60 ± 0.15	0.55 ± 0.10	0.40 ± 0.20	0.40 ± 0.20	9.5mg

\* Under development, RCW2012(12. '22), RCW3216(06. '22)

## Parts Numbering System

RCW	1608	J	101	CS
Code Designation	Dimension & Size Code	Tolerance	Resistance Value	Packing Code
High Power Chip Resistor	1608 : 1.6x0.8(mm)-0603(inch)	D : ±0.5% F : ±1.0% G : ±2.0% J : ±5.0%	3 or 4 digits coding system (IEC Coding system) 3 Digits(E-24 series) 4 Dights(E-96 series)  *Jumper : "000"	Packing Code

## Specification

Type	Size (inch)	Rated Power (W)	Rated Voltage (V)	Max working Voltage (V)	Max Overload Voltage (V)	Tolerance (%)	T.C.R (ppm/°C)	Resistance Range (Ω)	Working Temperature (°C)
RCW0603	0201	1/10	$\sqrt{P \times R}$	75	150	±0.5(D) ±1.0(F) ±2.0(G) ±5.0(J)	±700	1.0~9.9	-55~125
RCW1005	0402	1/5		150	300		±400	10~100	
RCW1608	0603	1/4		200	400		±250	101~10M	
RCW2012	0805	1/2		400	600		±700	1.0~9.9	
RCW3216	1206	1/1		200	400		±400	10~100	
						±200	101~10M		

## Power Derating Curve

- Rated power shall be the load power corresponding to nominal watt suitable for continuous use at 70 ±2°C ambient temperature. In case the ambient temperature exceeds 70±2°C, reduce the load power in accordance with the derating curve

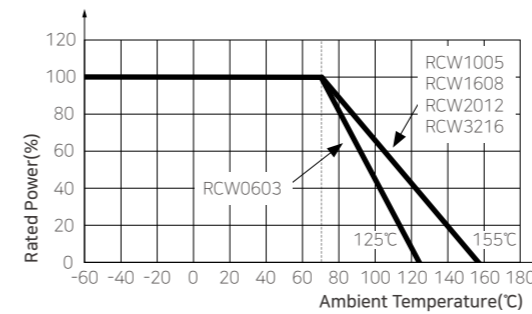

## Single Pulse

- The maximum applicable voltage is equal to the maximum overload voltage. Please contact factory for resistance characteristics of continuous applied pulse

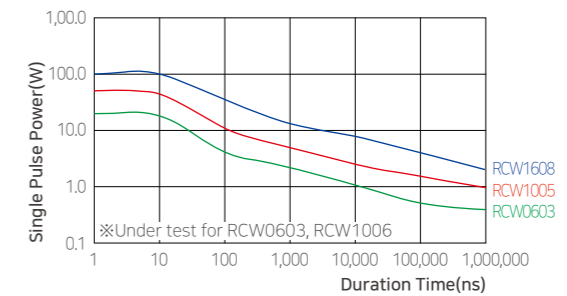

## Land Pattern

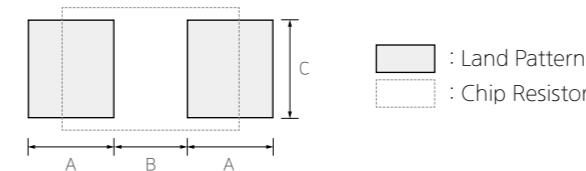

(Unit: mm)

Type	Size		Reflow Soldering			
	mm	inch	A	B	2A + B	C
RCW0603	0603	0201	0.37	0.28	1.02	0.29
RCW1005	1005	0402	0.60	0.50	1.70	0.50
RCW1608	1608	0603	0.80	0.80	2.40	0.80
RCW2012	2012	0805	0.90	1.40	3.20	1.20
RCW3216	3216	1206	1.30	1.80	4.40	1.50

The specifications and designs contained herein may be subject to change without notice. Please contact our sales representatives or product engineers before order.

Product Characteristic data Notes

General\_Standard Standard(RC)

General\_Standard Reverse(RCB)

Array Type Resistor Flat(RF, RM)

Array Type Resistor Concave(RN, RM, RK)

Array Type Resistor Convex(RP)

Current Sensing Resistor Low ohms(RUT)

Current Sensing Resistor Ultra Low ohms(RU, RUK)

Current Sensing Resistor Wide Terminal(RJ)

Meta\_CSR Metal Plate\_Clad(RLP, RLC)

High Power Resistor General(RCW)

High Voltage Chip Resistor (RCV)

Anti-Sulfur Resistor General, Array(RCS, RFS, RPS)

Lead free Chip Resistor General, Array, AntiSulfur

Center Common Array 3-Terminal Array(RFT)

Characteristics Performance

Packaging

Standard Resistance Value

Electrical & Mechanical Caution

Process of Mounting Soldering, Design

Caution of Application

# High Voltage Chip Resistor

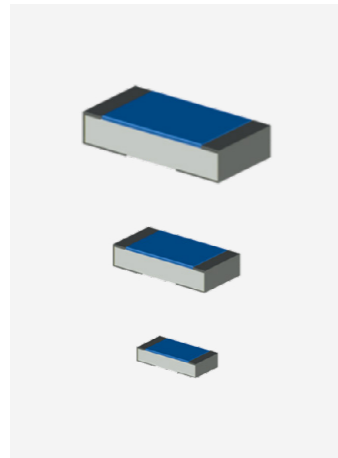

## Features

- Thick film type High-Power Resistor
- Higher Working Voltage with Anti-Surge and Anti-Pulse.
- Applicable Both flow and reflow soldering.
- Suitable size and package for surface mount assembly.
- RoHS Compliant.
- AEC-Q200 Compliant

## Application

- General purpose, Downsizing
- High Power, High Voltage
- Anti-Pulse, Anti-Surge(ESD)

## Structure, Dimensions and Specification

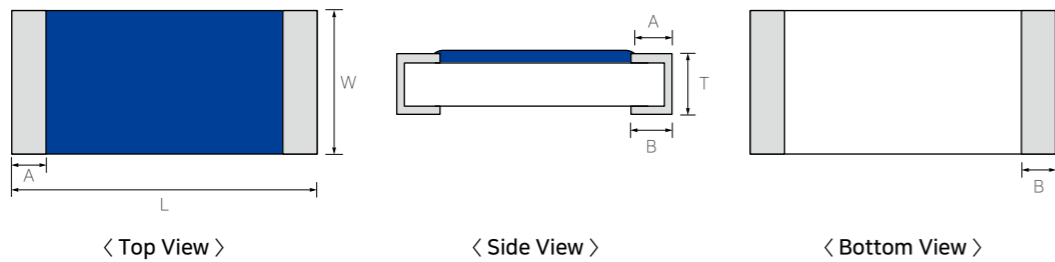

(Unit: mm)

Type	L	W	T	A	B	Weight (mg/K)
*RCV0603	0.60 ± 0.03	0.30 ± 0.03	0.23 ± 0.03	0.10 ± 0.05	0.15 ± 0.05	0.15mg
*RCV1005	1.00 ± 0.05	0.50 ± 0.05	0.35 ± 0.05	0.20 ± 0.10	0.25 ± 0.10	0.6mg
*RCV1608	1.60 ± 0.10	0.80 ± 0.10	0.45 ± 0.10	0.35 ± 0.15	0.35 ± 0.15	2.1mg
*RCV2012	2.00 ± 0.20	1.25 ± 0.15	0.55 ± 0.10	0.30 ± 0.20	0.35 ± 0.20	4.9mg
*RCV3216	3.20 ± 0.20	1.60 ± 0.15	0.55 ± 0.10	0.40 ± 0.20	0.40 ± 0.20	9.5mg

\* Under development, RCV0603~RCV1608(02. '22), RCV2012(03. '23), RCV3216(09. '22)

## Parts Numbering System

RCV	1608	J	101	CS
Code Designation	Dimension & Size Code	Tolerance	Resistance Value	Packing Code
High Voltage Chip Resistor	1608 : 1.6x0.8(mm)-0603(inch)	D : ±0.5% F : ±1.0% G : ±2.0% J : ±5.0%	3 or 4 digits coding system (IEC Coding system) 3 Digits(E-24 series) 4 Dights(E-96 series)  *Jumper : "000"	Packing Code

## Specification

Type	Size (inch)	Rated Power (W)	Rated Voltage (V)	Max working Voltage (V)	Max Overload Voltage (V)	Tolerance (%)	T.C.R (ppm/°C)	Resistance Range (Ω)	Working Temperature (°C)
RCV0603	0201	1/20	$\sqrt{P \times R}$	100	200	±0.5(D) ±1.0(F) ±2.0(G) ±5.0(J)	±700	1.0~9.9	-55~125
RCV1005	0402	1/16		200	400		±400	10~100	
RCV1608	0603	1/10		350	500		±250	101~10M	
RCV2012	0805	1/8		400	600		±700	1.0~9.9	
RCV3216	1206	1/4		500	1000		±400	10~100	
						±200	101~10M		

## Power Derating Curve

- Rated power shall be the load power corresponding to nominal watt suitable for continuous use at 70±2°C ambient temperature, In case the ambient temperature exceeds 70±2°C, reduce the load power in accordance with the derating curve

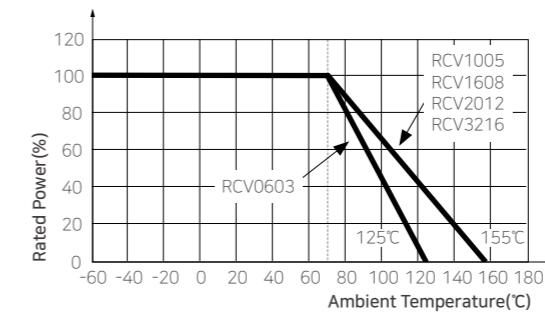

## Land Pattern

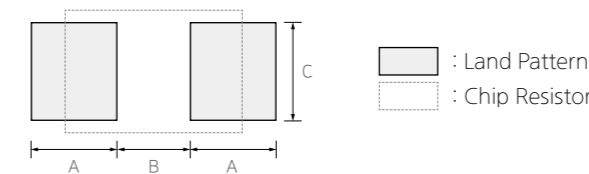

(Unit: mm)

Type	Size		Reflow Soldering			
	mm	inch	A	B	2A + B	C
RCV0603	0603	0201	0.37	0.28	1.02	0.29
RCV1005	1005	0402	0.60	0.50	1.70	0.50
RCV1608	1608	0603	0.80	0.80	2.40	0.80
RCV2012	2012	0805	0.90	1.40	3.20	1.20
RCV3216	3216	1206	1.30	1.80	4.40	1.50

The specifications and designs contained herein may be subject to change without notice. Please contact our sales representatives or product engineers before order.

Product Characteristic data Notes

General\_Standard Standard(RC)

General\_Standard Reverse(RCB)

Array Type Resistor Flat(RF, RM)

Array Type Resistor Concave(RN, RM, RK)

Array Type Resistor Convex(RP)

Current Sensing Resistor Low ohms(RUT)

Current Sensing Resistor Ultra Low ohms(RU, RUK)

Current Sensing Resistor Wide Terminal(RJ)

Meta\_CSR Metal Plate\_Clad(RLP,RLC)

High Power Resistor General(RCW)

High Voltage Chip Resistor (RCV)

Anti-Sulfur Resistor General, Array(RCS, RFS, RPS)

Lead free Chip Resistor General, Array, AntiSulfur

Center Common Array 3-Terminal Array(RFT)

Characteristics Performance

Packaging

Standard Resistance Value

Electrical & Mechanical Caution

Process of Mounting Soldering, Design

Caution of Application

# Anti-Sulfur Chip Resistor



## Features

- Stable in the Sulfur Atmosphere.
- ASTM B809-95 Satisfied
- Passed 720hrs with the dried Sulfur at 105℃
- High Precision Reliability.
- EU RoHS Compliant.
- AEC-Q200 Compliant.

## Application

- Electronic Devices with long-term reliability.
- Server system (Memory Module / HDD).
- Network Equipment.

## Structure, Dimensions and Specification

■ Same structures, Dimensions and Specifications as the corresponding sizes of non-anti-sulfur products

(1) Anti-Sulfur General (Same with General), Anti-Sulfur High Power(Same with High Power)

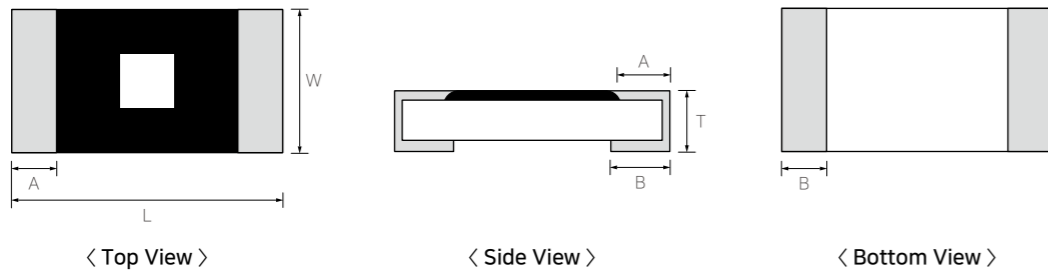

(2) Anti-Sulfur Array (Same with Array)

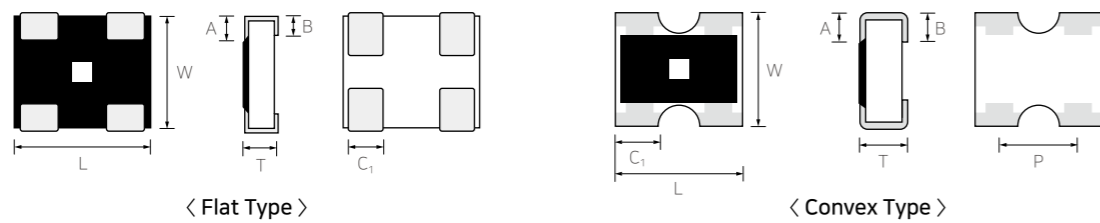

Division	Type	Corresponding Type	Refer to page	
			Structure and Dimensions	Specification
Anti-Sulfur General	General	(RCS) 0402, 0603, 1005, 1608, 3216, 3225, 5025, 6432	(RC) 0402, 0603, 1005, 1608, 3216, 3225, 5025, 6432	P.10 P.11
Anti-Sulfur Arrays	Flat Type	(RFS) 062P, 064P	(RF) 062P, 064P	P.14 P.15
	Convex Type	(RPS) 102P, 104P	(RP) 102P, 104P	P.16 P.17
Anti-Sulfur High Power	General	(RCWS) 0603, 1005, 1608	(RCW) 0603, 1005, 1608	P.30 P.31
Anti-Sulfur High Voltage	General	(RCVS) 0603, 1005, 1608	(RCV) 0603, 1005, 1608	P.32 P.33

## Parts Numbering System

■ The part number system shall be in the follow format

RCS	2012	J	100	CS	
Code Designation	Dimension & Size Code				
RCS : Anti-Sulfur General	0402 : 0.4×0.2(mm)-01005(inch) 0603 : 0.6×0.3(mm)-0201(inch) 1005 : 1.0×0.5(mm)-0402(inch) 1608 : 1.6×0.8(mm)-0603(inch) 2012 : 2.0×1.2(mm)-0805(inch) 3216 : 3.2×1.6(mm)-1206(inch) 3225 : 3.2×2.5(mm)-1210(inch) 5025 : 5.0×2.5(mm)-2010(inch) 6432 : 6.4×3.2(mm)-2512(inch)	D : ±0.5% F : ±1% G : ±2% J : ±5%  *Jumper : J	3 or 4 digits coding system (IEC coding system) 3digits (E-24 series) 4digits (E-96 series)  *Jumper : '000'	CS : Tape Packaging 7" ES : Tape Packaging 10" AS : Tape Packaging 13"	
RFS	06	4P	J	150	CS
Code Designation	Dimension	Resistors	Tolerance	Resistance Value	Packaging Code
RFS : Anti-Sulfur Flat	06 : 0201 Array	2P : 2 Pieces 4P : 4 Pieces	J : ±5%  *Jumper : J	3 digits coding system (IEC coding system) E-24 series  *Jumper : '000'	CS : Tape Packaging 7" ES : Tape Packaging 10" AS : Tape Packaging 13"
RPS	10	4P	J	100	CS
Code Designation	Dimension	Resistors	Tolerance	Resistance Value	Packaging Code
RPS : Anti-Sulfur Convex	10 : 0402 Array 16 : 0603 Array	2P : 2 Pieces 4P : 4 Pieces	F : ±1% G : ±2% J : ±5%  *Jumper : J	3 or 4 digits coding system (IEC coding system) 3digits (E-24 series) 4digits (E-96 series)  *Jumper : '000'	CS : Tape Packaging 7" ES : Tape Packaging 10" AS : Tape Packaging 13"

## Sulfur Corrosion Test

Test name	Adding Material	Temp.	Duration Time	Decision Criteria
ASTM B 809-95	Sulfur 50 g KNO <sub>3</sub> 200 g DIwater 200ml	50℃	720hrs	ΔR < ±1%
Dry Sulfur (IBM recommended)	Sulfur 50 g	105℃	720hrs	ΔR < ±1%

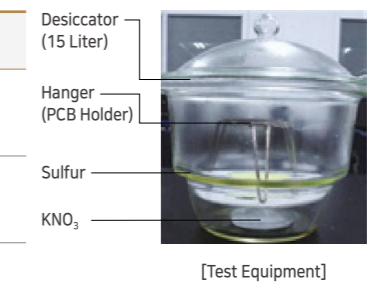

Product Characteristic data Notes

General\_Standard Standard(RC)

General\_Standard Reverse(RCB)

Array Type Resistor Flat(RF, RM)

Array Type Resistor Concave(RN, RM, RK)

Array Type Resistor Convex(RP)

Current Sensing Resistor Low ohms(RUT)

Current Sensing Resistor Ultra Low ohms(RU, RUK)

Current Sensing Resistor Wide Terminal(RJ)

Metal\_CSR Metal Plate\_Clad(RLP, RLC)

High Power Resistor General(RCW)

High Voltage Chip Resistor (RCV)

Anti-Sulfur Resistor General, Array(RCS, RFS, RPS)

Lead free Chip Resistor General, Array, AntiSulfur

Center Common Array 3-Terminal Array(RFT)

Characteristics Performance

Packaging

Standard Resistance Value

Electrical & Mechanical Caution

Process of Mounting Soldering, Design

Caution of Application

The specifications and designs contained herein may be subject to change without notice. Please contact our sales representatives or product engineers before order.

# Lead free Chip Resistor

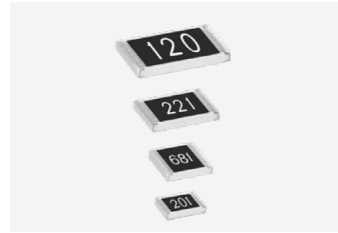

## Features

- Totally lead free
- EU RoHS Compliant.
- AEC-Q200 Compliant.

## Application

- General purpose
- Home Appliances (TV, Digital Display, Audio, etc)
- For Computers & Communications (Notebook, Mobile, etc)
- For semiconductor devices

## Structure, Dimensions and Specification

- Same structures, Dimensions and Specifications as the corresponding sizes of non-anti-sulfur products

Division	Type	Corresponding Type	Refer to page		
			Structure and Dimensions	Specification	
Lead free General	General	(RH) 0402, 0603, 1005, 1608, 2012, 3216, 3225, 5025, 6432	(RC) 0402, 0603, 1005, 1608, 2012, 3216, 3225, 5025, 6432	P.10	P.11
	Reverse	(RHB) 0603, 1005	(RCB) 0603, 1005	P.12	P.13
Lead free Arrays	Flat Type	(RFH) 062P, 064P (RMH) 062P, 064P	(RF) 062P, 064P (RM) 062P, 064P	P.14	P.15
	Concave type	(RNH) 102P, 104P (RMH) 102P, 104P (RKH) 102P, 104P	(RN) 102P, 104P (RM) 102P, 104P (RK) 102P, 104P	P.16	P.17
	Convex Type	(RPH) 102P, 104P	(RP) 102P, 104P	P.18	P.19
Lead free Anti Sulfur	General	(RHS) 0402, 0603, 1005, 1608, 2012, 3216, 3225, 5025, 6432	(RCS) 0402, 0603, 1005, 1608, 2012, 3216, 3225, 5025, 6432	P.30	P.31
Lead free Anti Sulfur Arrays	Flat Type	(RFHS) 062P, 064P	(RFS) 062P, 064P	P.32	P.33
	Convex Type	(RPHS) 102P, 104P	(RPS) 102P, 104P	P.34	P.35

## Parts Numbering System

- The part number system shall be in the follow format

RH	2012	J	100	CS
Code Designation	Dimension & Size Code	Tolerance	Resistance Value	Packaging Code
RH : Lead Free Chip Resistor	0402 : 0.4×0.2(mm)-01005(inch)	D : ±0.5% F : ±1% G : ±2% J : ±5%  *Jumper : J	3 or 4 digits coding system (IEC coding system) 3digits (E-24 series) 4digits (E-96 series)  *Jumper : '000'	CS : Tape Packaging 7" ES : Tape Packaging 10" AS : Tape Packaging 13"
	0603 : 0.6×0.3(mm)-0201(inch)			
	1005 : 1.0×0.5(mm)-0402(inch)			
	1608 : 1.6×0.8(mm)-0603(inch)			
	2012 : 2.0×1.2(mm)-0805(inch)			
	3216 : 3.2×1.6(mm)-1206(inch)			
	3225 : 3.2×2.5(mm)-1210(inch)			
5025 : 5.0×2.5(mm)-2010(inch)				
6432 : 6.4×3.2(mm)-2512(inch)				

RCB	603	J	100	CS
Code Designation	Dimension & Size Code	Tolerance	Resistance Value	Packaging Code
RHB : Lead Free Reverse Chip Resistor	0603 : 0.6×0.3(mm)-0201(inch)	D : ±0.5% F : ±1% G : ±2% J : ±5%  *Jumper : J	3 or 4 digits coding system (IEC coding system) 3digits (E-24 series) 4digits (E-96 series)  *Jumper : '000'	CS : Tape Packaging 7" ES : Tape Packaging 10" AS : Tape Packaging 13"
	1005 : 1.0×0.5(mm)-0402(inch)			

## Parts Numbering System

- The part number system shall be in the follow format

RFH	06	4P	J	150	CS
Code Designation	Dimension	Resistors	Tolerance	Resistance Value	Packaging Code
RFH : Lead free Flat RMH : Lead free Inverted & Flat	06 : 0201 Array	2P : 2 Pieces 4P : 4 Pieces	J : ±5%  *Jumper : J	3 digit coding system (IEC coding system) E-24 series  *Jumper : '000'	CS : Tape & Reel 7" ES : Tape & Reel 10" AS : Tape & Reel 13"
RNH : Lead free Concave RMH : Lead free Inverted Concave RKH : Lead free Short-free & Inverted		2P : 2 Pieces 4P : 4 Pieces	F : ±1% J : ±5%  *Jumper : J		
RPH : Lead free Convex	10 : 0402 Array 16 : 0603 Array	2P : 2 Pieces 4P : 4 Pieces	J : ±5%  *Jumper : J	3 digit coding system (IEC coding system) E-24 series  *Jumper : '000'	CS : Tape & Reel 7" ES : Tape & Reel 10" AS : Tape & Reel 13"

RHS	2012	J	100	CS
Code Designation	Dimension & Size Code	Tolerance	Resistance Value	Packaging Code
RHS : Lead free Anti-Sulfur General	0402 : 0.4×0.2(mm) - 01005(inch)	D : ±0.5% F : ±1% G : ±2% J : ±5%  *Jumper : J	3 or 4 digits coding system (IEC coding system) 3digits(E-24 series) 4digits(E-96 series)  *Jumper : '000'	CS : Tape & Reel 7" ES : Tape & Reel 10" AS : Tape & Reel 13"
	0603 : 0.6×0.3(mm) - 0201(inch)			
	1005 : 1.0×0.5(mm) - 0402(inch)			
	1608 : 1.6×0.8(mm) - 0603(inch)			
	2012 : 2.0×1.2(mm) - 0805(inch)			
	3216 : 3.2×1.6(mm) - 1206(inch)			
	3225 : 3.2×2.5(mm) - 1210(inch)			
5025 : 5.0×2.5(mm) - 2010(inch)				
6432 : 6.4×3.2(mm) - 2512(inch)				

RFHS	06	4P	J	150	CS
Code Designation	Dimension	Resistors	Tolerance	Resistance Value	Packaging Code
RFHS : Lead free Anti-Sulfur Flat	06 : 0201 Array	2P : 2 Pieces 4P : 4 Pieces	J : ±5%  *Jumper : J	3 digit coding system (IEC coding system) E-24 series  *Jumper : '000'	CS : Tape & Reel 7" ES : Tape & Reel 10" AS : Tape & Reel 13"
RPHS : Lead free Anti-Sulfur Convex		2P : 2 Pieces 4P : 4 Pieces	F : ±1% G : ±2% J : ±5%  *Jumper : J		

The specifications and designs contained herein may be subject to change without notice. Please contact our sales representatives or product engineers before order.

Product Characteristic data Notes

General\_Standard Standard(RC)

General\_Standard Reverse(RCB)

Array Type Resistor Flat(RF, RM)

Array Type Resistor Concave(RN, RM, RK)

Array Type Resistor Convex(RP)

Current Sensing Resistor Low ohms(RUT)

Current Sensing Resistor Ultra Low ohms(RU, RUK)

Current Sensing Resistor Wide Terminal(RJ)

Metal\_CSR Metal Plate\_Clad(RLP,RLC)

High Power Resistor General(RCW)

High Voltage Chip Resistor (RCV)

Anti-Sulfur Resistor General, Array(RCS, RFS, RPS)

Lead free Chip Resistor General, Array, AntiSulfur

Center Common Array 3-Terminal Array(RFT)

Characteristics Performance

Packaging

Standard Resistance Value

Electrical & Mechanical Caution

Process of Mounting Soldering, Design

Caution of Application

# Center Common Array 3-Terminal Array(RFT)

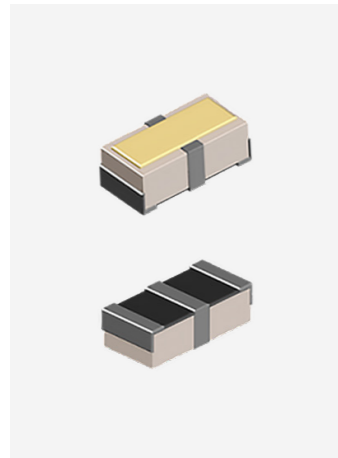

## Features

- Saving SMD surface area
- Saving SMD cost
- Three Terminal Two Resistance
- Customized Resistance Array
- RoHS Compliant.

## Application

- For semiconductor devices.
- For mobile, digital circuits.

## Structure, Dimensions and Specification

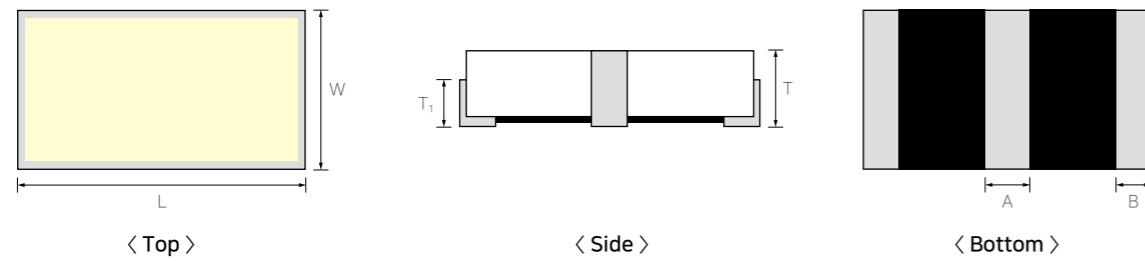

(Unit: mm)

Type	L	W	T	T <sub>1</sub>	A	B	Average Weight
RFT032P	0.61 ± 0.03	0.30 ± 0.03	0.22 ± 0.03	0.04 ± 0.03	0.10 ± 0.03	0.095 ± 0.03	0.15 mg

## Parts Numbering System

■ The part number system shall be in the follow format

RFT	3	2P	J	101	CS
Code Designation	Dimension	Resistors	Tolerance	Resistance Value	Packaging Code

RFT : Center Common Array	03 : 0603 Array	032P : 2 Pieces	J : ± 5%	3 digits coding system (EC coding system) E-24 series	CS : Tape Packaging 7" ES : Tape Packaging 10" AS : Tape Packaging 13"
---------------------------	-----------------	-----------------	----------	---	--

## Specification

Type	Size (inch)	Rated Power [W]	Rated Voltage [V]	Tolerance (%)	Resistance Range (Ω)	T.C.R. (ppm/°C)	Working Temperature (°C)	Rated Ambient Temperature (°C)	Moisture Level
RFT032P	0101	1/32	$\sqrt{P \times R}$ P : Rated Power(W) R : Resistance(Ω)	F: ±1% J: ±5%	1kΩ ~51kΩ	300	-55~125°C	70	Level 1

## Power Derating Curve

- The rated power is the maximum continuous loading power at 70°C ambient temperature. For ambient temperature above 70°C, the loading power follows the below power derating curve.

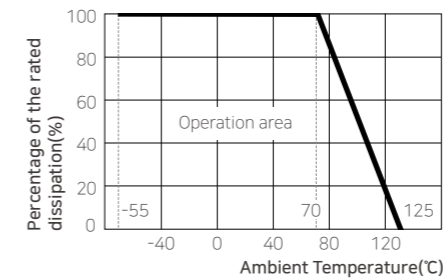

## Land Pattern

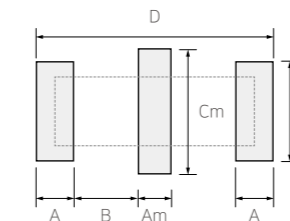

Dimension	A	Am	B	D (2A+2B+Am)	C	Cm
RFT032P	0.15	0.16	0.155	0.77	0.3	0.36

The specifications and designs contained herein may be subject to change without notice. Please contact our sales representatives or product engineers before order.

Product Characteristic data Notes

General\_Standard Standard(RC)

General\_Standard Reverse(RCB)

Array Type Resistor Flat(RF, RM)

Array Type Resistor Concave(RN, RM, RK)

Array Type Resistor Convex(RP)

Current Sensing Resistor Low ohms(RUT)

Current Sensing Resistor Ultra Low ohms(RU, RUK)

Current Sensing Resistor Wide Terminal(RJ)

Metal\_CSR Metal Plate\_Clad(RLP,RLC)

High Power Resistor General(RCW)

High Voltage Chip Resistor (RCV)

Anti-Sulfur Resistor General, Array(RCS, RFS, RPS)

Lead free Chip Resistor General, Array, AntiSulfur

### Center Common Array 3-Terminal Array(RFT)

Characteristics Performance

Packaging

Standard Resistance Value

Electrical & Mechanical Caution

Process of Mounting Soldering, Design

Caution of Application

# Characteristics Performance

## Electrical Characteristic

Item	Requirements Specification		Test Method
	Resistor	Jumper	
DC resistance	1. DC resistance value should be within the specified resistance tolerance.	Less Than 50mΩ	<ul style="list-style-type: none"> <li>Standard : JIS C 5201-1 (4.5)</li> <li>Voltage apply within 5sec</li> <li>Temp(20°C), Humidity(65% RH)</li> <li>[ Fig 4 ]</li> </ul>
Temperature Coefficient of resistance(TCR)	Refer to the specification		<ul style="list-style-type: none"> <li>Standard : JIS C 5201-1 (4.8)</li> <li>Temp(°C)</li> <li>+20 → -55 → 20 → 125 → 20°C</li> <li>Calculation(ppm/°C)</li> <li>TCR = (R-R<sub>0</sub>)/R<sub>0</sub> × 1(T-T<sub>0</sub>)×10<sup>6</sup></li> <li>- T<sub>0</sub> : 20±2°C</li> <li>- R<sub>0</sub> : Resistance at 20°C(Ω)</li> <li>- T : Test temperature(-55,+125°C)</li> <li>- R : Resistance at -55 or +125°C(Ω)</li> </ul>
Short time overload (STOL)	1. No mechanical damage 2. ΔR should be within ±(1.0%+0.1Ω)	Less Than 50mΩ	<ul style="list-style-type: none"> <li>Standard : JIS C 5201-1 (4.13)</li> <li>Voltage : 2.5 times of rated voltage</li> <li>Times : 5sec</li> </ul>
Intermittent overload (IMOL)	1. No mechanical damage 2. ΔR should be within ±(3.0%+0.1Ω)	Less Than 50mΩ	<ul style="list-style-type: none"> <li>Standard : JIS C 5201-1 (4.39)</li> <li>Voltage : 2.5 times of rated voltage</li> <li>Test method</li> <li>- 1sec on, 25sec off, 10,000<sup>+400</sup>Cycle</li> </ul>
Dielectric withstanding Voltage	1. No mechanical damage, short circuit or disconnection.		<ul style="list-style-type: none"> <li>Standard : JIS C 5201-1 (4.7)</li> <li>Voltage : - 0402, 0603 : DC 50V</li> <li>- 1005, 1608 : DC 100V</li> <li>- 2012~6432 : DC 500V</li> <li>Times : 60sec</li> </ul>
Insulation resistance	1. Insulation resistance should be higher than 1,000MΩ		<ul style="list-style-type: none"> <li>Standard : JIS C 5201-1 (4.6)</li> <li>Voltage : - 0402, 0603 : DC 50V</li> <li>- 1005, 1608 : DC 100V</li> <li>- 2012~6432 : DC 500V</li> <li>Times : 60sec</li> </ul>
ESD Characteristics (only for high power resistor)	1. No mechanical damage 2. ΔR should be within ±(5.0%+0.1Ω)	Less Than 50mΩ	<ul style="list-style-type: none"> <li>Standard : JEDEC-A114(HBM)</li> <li>C : 100pF</li> <li>R : 1.5kΩ</li> <li>Times : +/- 3 times</li> <li>Voltage : 1KV~8KV</li> </ul>

## Mechanical Characteristic

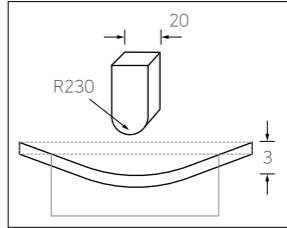
Item	Requirements Specification		Test Method
	Resistor	Jumper	
Solderability	1. Solder should cover more than 95% of termination. 2. No crack of termination parts and no ceramic exposure of surface by melting.		<ul style="list-style-type: none"> <li>Standard : JIS C 5201-1 (4.17)</li> <li>Temp : 245±5°C</li> <li>Times : 2±0.5sec(Dipping both side)</li> </ul>
Bending Strength	1. No mechanical damage 2. ΔR should be within ±(1.0% + 0.05Ω)	Less Than 50mΩ	<ul style="list-style-type: none"> <li>Standard : JIS C 5201-1 (4.33)</li> <li>Test method :</li> <li>After soldering resistance on the PCB press to 3mm, then keep 10sec.</li> <li>Pressure speed : 1mm/1Sec</li> <li>[ Fig 5 ]</li> </ul> 
Adhesive strength of Termination	1. No mechanical damage or sign of disconnection.		<ul style="list-style-type: none"> <li>Standard : JIS C 5201-1 (4.32)</li> <li>Strength</li> <li>- 0402~0603(2N or 200gf)</li> <li>- 1005~1608(5N or 500gf)</li> <li>Times : Pressure for 10sec.</li> </ul>
Resistance to soldering heat	1. No mechanical damage 2. ΔR should be within ±(1.0% + 0.05Ω)	Less Than 50mΩ	<ul style="list-style-type: none"> <li>Standard : JIS C 5201-1 (4.18)</li> <li>Temp(260°C)</li> <li>- Flow : Max 10sec(Both side dipping)</li> <li>- Reflow : Max 10sec(230°C ↑ , 30sec)</li> <li>Measure method</li> <li>- Wait 60 minutes at room temp. and then measure the resistance value.</li> </ul>
Anti-Vibration	1. No mechanical damage 2. ΔR should be within ±(1.0% + 0.05Ω)	Less Than 50mΩ	<ul style="list-style-type: none"> <li>Standard : JIS C 5201-1 (4.22)</li> <li>Measure method</li> <li>- 2 Hours each in x, y and z axis (total 6 hours)</li> <li>- 10 to 55Hz sweep in 1 minute at 1.5mm amplitude.</li> </ul>

# Characteristics Performance

## Environmental Characteristic

Item	Requirements Specification		Test Method
	Resistor	Jumper	
Temperature Cycle	1. No mechanical damage 2. $\Delta R$ should be within $\pm(1.0\%+0.1\Omega)$	Less than 50m $\Omega$	<ul style="list-style-type: none"> <li>Standard : JIS C 5201-1 (4.19)</li> <li>Cycle : Perform 100 cycles as follow</li> <li>Cycle step(°C) - 20 → -55/30min → 20 → 125/30min</li> </ul>
Moisture resistance (Damp heat with load)	1. No mechanical damage 2. $\Delta R$ should be within $\pm(3.0\%+0.1\Omega)$	Less than 50m $\Omega$	<ul style="list-style-type: none"> <li>Standard : JIS C 5201-1 (4.24)</li> <li>Condition - Temp(40±2°C), Humidity(93±3% RH)</li> <li>Voltage : Rated Voltage</li> <li>Times - 1,000±48 hours - 90min On, 30min Off</li> </ul>
Low temperature exposure	1. No mechanical damage 2. $\Delta R$ should be within $\pm(3.0\%+0.1\Omega)$	Less than 50m $\Omega$	<ul style="list-style-type: none"> <li>Standard : JIS C 5201-1 (4.23)</li> <li>Temp : -55±2°C</li> <li>Times : 1,000±48 hours - Not applied load</li> <li>Measure method - Keep 60 minutes in room temp before measuring</li> </ul>
High temperature exposure	1. No mechanical damage 2. $\Delta R$ should be within $\pm(3.0\%+0.1\Omega)$	Less than 50m $\Omega$	<ul style="list-style-type: none"> <li>Standard : JIS C 5201-1 (4.23)</li> <li>Temp - 04023, 0603 : +125±2°C - 1005~6432 : +155±2°C</li> <li>Times : 1,000±48 hours - Not applied load</li> <li>Measure method - Keep 60 minutes in room temp before measuring</li> </ul>
Load life	1. No mechanical damage 2. $\Delta R$ should be within $\pm(3.0\%+0.1\Omega)$	Less than 50m $\Omega$	<ul style="list-style-type: none"> <li>Standard : JIS C 5201-1 (4.25)</li> <li>Temp : 70±2°C</li> <li>Voltage : Rated Voltage</li> <li>Times - 1,000±48 hours - 90min On, 30min Off</li> <li>Measure method - Keep 60 minutes in room temp before measuring</li> </ul>
Flower of Sulfur (Sulfur corrosion)	1. $\Delta R$ should be within $\pm(1.0\%+0.1\Omega)$	Less than 50m $\Omega$	<ul style="list-style-type: none"> <li>Standard : ASTM-B-809</li> <li>Temp : 105±2°C</li> <li>Test Time - 720±2hours, - Not applied load</li> <li>Measure method : Keep 2 hours in room temp before measuring</li> <li>Test board : [ fig 6 ]</li> </ul>

## Test Flow soldering Conditions

Item	Specification	Dipping
Flux	ROSIN 25%, IPA 75%	Time: 5~10 sec.
Solder	Sn-3.0Ag-0.5Cu	Time : 10 sec max. Temp. : 260±5°C.

Product Characteristic data Notes

General\_Standard Standard(RC)

General\_Standard Reverse(RCB)

Array Type Resistor Flat(RF, RM)

Array Type Resistor Concave(RN, RM, RK)

Array Type Resistor Convex(RP)

Current Sensing Resistor Low ohms(RUT)

Current Sensing Resistor Ultra Low ohms(RU, RUK)

Current Sensing Resistor Wide Terminal(RJ)

Metal\_CSR Metal Plate\_Clad(RLP, RLC)

High Power Resistor General(RCW)

High Voltage Chip Resistor (RCV)

Anti-Sulfur Resistor General, Array(RCS, RFS, RPS)

Lead free Chip Resistor General, Array, AntiSulfur

Center Common Array 3-Terminal Array(RFT)

### Characteristics Performance

Packaging

Standard Resistance Value

Electrical &amp; Mechanical Caution

Process of Mounting Soldering, Design

Caution of Application

# Packaging

## Taping Type

### Reel dimensions

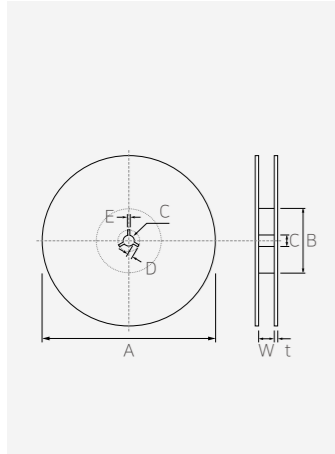

(Unit: mm)

Symbol	Tape Width	A	B	C	D
7" Reel	8mm	∅ 180+0/-3	∅ 60 ± 1.0	∅ 13.0 ± 0.3	4 ± 0.2
	12mm	∅ 180+0/-3	∅ 60 ± 1.0	∅ 13.0 ± 0.3	4 ± 0.2
10" Reel	8mm	∅ 258 ± 3	∅ 81 ± 1.0	∅ 13 ± 0.3	4 ± 0.2
	12mm	∅ 258 ± 3	∅ 81 ± 1.0	∅ 13 ± 0.3	4 ± 0.2
13" Reel	8mm	∅ 330 ± 2.0	∅ 100 ± 1.0	∅ 13 ± 0.5	4 ± 0.2
	12mm	∅ 330 ± 2.0	∅ 100 ± 1.0	∅ 13 ± 0.5	4 ± 0.2

Symbol	Tape Width	E	W	T
7" Reel	8mm	2.0 ± 0.5	9 ± 0.5	1.2 ± 0.2
	12mm	2.0 ± 0.5	13 ± 0.5	1.2 ± 0.2
10" Reel	8mm	2.0 ± 0.5	9 ± 0.5	1.8 ± 0.2
	12mm	2.0 ± 0.5	13 ± 0.5	1.8 ± 0.2
13" Reel	8mm	3.3 ± 0.5	9 ± 0.5	2.2 ± 0.2
	12mm	3.3 ± 0.5	13 ± 0.5	2.2 ± 0.2

### Tape dimensions

(Unit: mm)

Type	Pitch	Carrier Width	Dimensions																																															
Pressed Paper	1mm	8mm	<table border="1"> <thead> <tr> <th>Type</th> <th>Size</th> <th>Size (inch)</th> <th>A</th> <th>B</th> <th>T</th> </tr> </thead> <tbody> <tr> <td rowspan="2">RC/RCS</td> <td>0402</td> <td>01005</td> <td>0.24±0.03</td> <td>0.45±0.03</td> <td>0.31±0.02</td> </tr> <tr> <td>0603</td> <td>0201</td> <td>0.38±0.05</td> <td>0.68±0.05</td> <td>0.42±0.05</td> </tr> </tbody> </table>	Type	Size	Size (inch)	A	B	T	RC/RCS	0402	01005	0.24±0.03	0.45±0.03	0.31±0.02	0603	0201	0.38±0.05	0.68±0.05	0.42±0.05																														
	Type	Size	Size (inch)	A	B	T																																												
RC/RCS	0402	01005	0.24±0.03	0.45±0.03	0.31±0.02																																													
	0603	0201	0.38±0.05	0.68±0.05	0.42±0.05																																													
2mm	8mm	<table border="1"> <thead> <tr> <th>Type</th> <th>Size</th> <th>Size (inch)</th> <th>A</th> <th>B</th> <th>T</th> </tr> </thead> <tbody> <tr> <td rowspan="2">RC/RCS</td> <td>0402</td> <td>01005</td> <td>0.24±0.03</td> <td>0.45±0.03</td> <td>0.31±0.02</td> </tr> <tr> <td>0603</td> <td>0201</td> <td>0.38±0.05</td> <td>0.68±0.05</td> <td>0.42±0.05</td> </tr> <tr> <td>RFT</td> <td>032P</td> <td>0201</td> <td>0.40±0.05</td> <td>0.70±0.05</td> <td>0.42±0.05</td> </tr> </tbody> </table>	Type	Size	Size (inch)	A	B	T	RC/RCS	0402	01005	0.24±0.03	0.45±0.03	0.31±0.02	0603	0201	0.38±0.05	0.68±0.05	0.42±0.05	RFT	032P	0201	0.40±0.05	0.70±0.05	0.42±0.05																									
Type	Size	Size (inch)	A	B	T																																													
RC/RCS	0402	01005	0.24±0.03	0.45±0.03	0.31±0.02																																													
	0603	0201	0.38±0.05	0.68±0.05	0.42±0.05																																													
RFT	032P	0201	0.40±0.05	0.70±0.05	0.42±0.05																																													
Punched Paper	2mm	8mm	<table border="1"> <thead> <tr> <th>Type</th> <th>Size</th> <th>Size (inch)</th> <th>A</th> <th>B</th> <th>T</th> </tr> </thead> <tbody> <tr> <td rowspan="2">RC/RCS/RU/RUT</td> <td>1005</td> <td>0402</td> <td>0.65±0.10</td> <td>1.15±0.10</td> <td>0.43±0.07</td> </tr> <tr> <td>062P</td> <td>0302</td> <td>0.70±0.10</td> <td>0.90±0.10</td> <td>0.30±0.05</td> </tr> <tr> <td rowspan="2">RM/RFS</td> <td>064P</td> <td>0502</td> <td>0.70±0.10</td> <td>1.60±0.10</td> <td>0.30±0.05</td> </tr> <tr> <td>102P</td> <td>0404</td> <td>1.17±0.10</td> <td>1.20±0.10</td> <td>0.43±0.07</td> </tr> <tr> <td rowspan="2">RP/RPS</td> <td>104P</td> <td>0804</td> <td>1.20±0.10</td> <td>2.20±0.10</td> <td>0.43±0.07</td> </tr> <tr> <td>102P</td> <td>0404</td> <td>1.20±0.10</td> <td>1.20±0.10</td> <td>0.43±0.07</td> </tr> <tr> <td rowspan="2">RM/RK</td> <td>104P</td> <td>0804</td> <td>1.20±0.10</td> <td>2.20±0.10</td> <td>0.60±0.10</td> </tr> </tbody> </table>	Type	Size	Size (inch)	A	B	T	RC/RCS/RU/RUT	1005	0402	0.65±0.10	1.15±0.10	0.43±0.07	062P	0302	0.70±0.10	0.90±0.10	0.30±0.05	RM/RFS	064P	0502	0.70±0.10	1.60±0.10	0.30±0.05	102P	0404	1.17±0.10	1.20±0.10	0.43±0.07	RP/RPS	104P	0804	1.20±0.10	2.20±0.10	0.43±0.07	102P	0404	1.20±0.10	1.20±0.10	0.43±0.07	RM/RK	104P	0804	1.20±0.10	2.20±0.10	0.60±0.10		
			Type	Size	Size (inch)	A	B	T																																										
	RC/RCS/RU/RUT	1005	0402	0.65±0.10	1.15±0.10	0.43±0.07																																												
		062P	0302	0.70±0.10	0.90±0.10	0.30±0.05																																												
	RM/RFS	064P	0502	0.70±0.10	1.60±0.10	0.30±0.05																																												
		102P	0404	1.17±0.10	1.20±0.10	0.43±0.07																																												
RP/RPS	104P	0804	1.20±0.10	2.20±0.10	0.43±0.07																																													
	102P	0404	1.20±0.10	1.20±0.10	0.43±0.07																																													
RM/RK	104P	0804	1.20±0.10	2.20±0.10	0.60±0.10																																													
	4mm	8mm	<table border="1"> <thead> <tr> <th>Type</th> <th>Size</th> <th>Size (inch)</th> <th>A</th> <th>B</th> <th>T</th> </tr> </thead> <tbody> <tr> <td rowspan="3">RC/RCS/RU/RUT/RUK/RJ</td> <td>1608</td> <td>0603</td> <td>1.10±0.20</td> <td>1.90±0.20</td> <td>0.60±0.10</td> </tr> <tr> <td>0816</td> <td>0306</td> <td>1.10±0.20</td> <td>1.90±0.20</td> <td>0.60±0.10</td> </tr> <tr> <td>2012</td> <td>0805</td> <td>1.65±0.20</td> <td>2.40±0.20</td> <td>0.75±0.10</td> </tr> <tr> <td rowspan="2">1220</td> <td>0508</td> <td>1.65±0.20</td> <td>2.40±0.20</td> <td>0.75±0.10</td> </tr> <tr> <td>3216</td> <td>1206</td> <td>2.00±0.20</td> <td>3.60±0.20</td> <td>0.75±0.10</td> </tr> <tr> <td>1632</td> <td>0612</td> <td>2.90±0.20</td> <td>5.40±0.20</td> <td>1.00±0.10</td> </tr> <tr> <td>3225</td> <td>1210</td> <td>2.90±0.20</td> <td>5.40±0.20</td> <td>1.00±0.10</td> </tr> <tr> <td>RC/RPS</td> <td>164P</td> <td>1206</td> <td>2.00±0.20</td> <td>3.60±0.20</td> <td>0.75±0.10</td> </tr> </tbody> </table>	Type	Size	Size (inch)	A	B	T	RC/RCS/RU/RUT/RUK/RJ	1608	0603	1.10±0.20	1.90±0.20	0.60±0.10	0816	0306	1.10±0.20	1.90±0.20	0.60±0.10	2012	0805	1.65±0.20	2.40±0.20	0.75±0.10	1220	0508	1.65±0.20	2.40±0.20	0.75±0.10	3216	1206	2.00±0.20	3.60±0.20	0.75±0.10	1632	0612	2.90±0.20	5.40±0.20	1.00±0.10	3225	1210	2.90±0.20	5.40±0.20	1.00±0.10	RC/RPS	164P	1206	2.00±0.20	3.60±0.20
Type			Size	Size (inch)	A	B	T																																											
RC/RCS/RU/RUT/RUK/RJ	1608	0603	1.10±0.20	1.90±0.20	0.60±0.10																																													
	0816	0306	1.10±0.20	1.90±0.20	0.60±0.10																																													
	2012	0805	1.65±0.20	2.40±0.20	0.75±0.10																																													
1220	0508	1.65±0.20	2.40±0.20	0.75±0.10																																														
	3216	1206	2.00±0.20	3.60±0.20	0.75±0.10																																													
1632	0612	2.90±0.20	5.40±0.20	1.00±0.10																																														
3225	1210	2.90±0.20	5.40±0.20	1.00±0.10																																														
RC/RPS	164P	1206	2.00±0.20	3.60±0.20	0.75±0.10																																													
4mm	12mm	<table border="1"> <thead> <tr> <th>Type</th> <th>Size</th> <th>Size (inch)</th> <th>A</th> <th>B</th> <th>T</th> </tr> </thead> <tbody> <tr> <td rowspan="2">RC/RCS/RU/RUT/RUK/RJ/RLC</td> <td>2037</td> <td>0815</td> <td>2.30±0.20</td> <td>4.00±0.20</td> <td>1.00±0.10</td> </tr> <tr> <td>5025</td> <td>2010</td> <td>2.90±0.20</td> <td>5.40±0.20</td> <td>1.00±0.10</td> </tr> <tr> <td rowspan="2">6432</td> <td>2512</td> <td>3.30±0.20</td> <td>6.60±0.20</td> <td>1.00±0.10</td> </tr> <tr> <td>3264</td> <td>1225</td> <td>3.30±0.20</td> <td>6.60±0.20</td> <td>1.00±0.10</td> </tr> </tbody> </table>	Type	Size	Size (inch)	A	B	T	RC/RCS/RU/RUT/RUK/RJ/RLC	2037	0815	2.30±0.20	4.00±0.20	1.00±0.10	5025	2010	2.90±0.20	5.40±0.20	1.00±0.10	6432	2512	3.30±0.20	6.60±0.20	1.00±0.10	3264	1225	3.30±0.20	6.60±0.20	1.00±0.10																					
		Type	Size	Size (inch)	A	B	T																																											
RC/RCS/RU/RUT/RUK/RJ/RLC	2037	0815	2.30±0.20	4.00±0.20	1.00±0.10																																													
	5025	2010	2.90±0.20	5.40±0.20	1.00±0.10																																													
6432	2512	3.30±0.20	6.60±0.20	1.00±0.10																																														
	3264	1225	3.30±0.20	6.60±0.20	1.00±0.10																																													
4mm	12mm	<table border="1"> <thead> <tr> <th>Type</th> <th>Size</th> <th>Size (inch)</th> <th>A</th> <th>B</th> <th>T</th> </tr> </thead> <tbody> <tr> <td rowspan="2">RC/RCS/RU/RUT/RUK/RJ/RLC</td> <td>2037</td> <td>0815</td> <td>2.30±0.20</td> <td>4.00±0.20</td> <td>1.00±0.10</td> </tr> <tr> <td>5025</td> <td>2010</td> <td>2.90±0.20</td> <td>5.40±0.20</td> <td>1.00±0.10</td> </tr> <tr> <td rowspan="2">6432</td> <td>2512</td> <td>3.30±0.20</td> <td>6.60±0.20</td> <td>1.00±0.10</td> </tr> <tr> <td>3264</td> <td>1225</td> <td>3.30±0.20</td> <td>6.60±0.20</td> <td>1.00±0.10</td> </tr> </tbody> </table>	Type	Size	Size (inch)	A	B	T	RC/RCS/RU/RUT/RUK/RJ/RLC	2037	0815	2.30±0.20	4.00±0.20	1.00±0.10	5025	2010	2.90±0.20	5.40±0.20	1.00±0.10	6432	2512	3.30±0.20	6.60±0.20	1.00±0.10	3264	1225	3.30±0.20	6.60±0.20	1.00±0.10																					
Type	Size	Size (inch)	A	B	T																																													
RC/RCS/RU/RUT/RUK/RJ/RLC	2037	0815	2.30±0.20	4.00±0.20	1.00±0.10																																													
	5025	2010	2.90±0.20	5.40±0.20	1.00±0.10																																													
6432	2512	3.30±0.20	6.60±0.20	1.00±0.10																																														
	3264	1225	3.30±0.20	6.60±0.20	1.00±0.10																																													

## Packing Table

Type (mm)	Type (inch)	Taping Packaging				
		Code	Reel	Carrier Tape	Quantity	Weight
0402	1005	CS	7"	Pressed Paper	20,000	138
		AS	7"	Pressed Paper	15,000	121
0603	0201	AS	13"	Pressed Paper	60,000	573
		WS	13"		150,000	695
032P	0201	CS	7"	Pressed Paper	20,000	121
		AS	13"	Pressed Paper	60,000	573
1005	0402	CS	7"	Punched Paper	10,000	87
		ES	10"		30,000	331
		AS	13"		40,000	539
1608 0816*	0603 0306*	CS	7"	Punched Paper	5,000	120
		ES	10"		10,000	324
		AS	13"		20,000	561
2012 1220*	0805 0508*	CS	7"	Punched Paper	5,000	144
		ES	10"		10,000	360
		AS	13"		20,000	658
1220 2mΩ	0508*	CS	7"	Embossed Plastic	4,000	100
3216 1632	1206 0612*	CS	7"	Punched Paper	5,000	152
		ES	10"		10,000	382
		AS	13"		20,000	695
3225	1210	CS	7"	Punched Paper	5,000	178
		ES	10"		10,000	463
		AS	13"		20,000	674
		CS	7"	Embossed Plastic	4,000	145
5025	2010	CS	7"	Embossed Plastic	4,000	197
6432 3264*	2512 1225*	CS	7"	Embossed Plastic	4,000	262
		AS	13"		15,000	1,041
6432**	2512**	CS	7"	Embossed Plastic	4,000	470
062P	0201×2R	CS	7"	Punched Paper	20,000	134
		AS	13"		60,000	573
064P	0201×4R	CS	7"	Punched Paper	20,000	137
		AS	13"		60,000	573
102P	0402×2R	CS	7"	Punched Paper	10,000	95
		AS	13"		40,000	485
104P	0402×4R	CS	7"	Punched Paper	10,000	131
		AS	13"		40,000	610
164P	0603×4R	CS	7"	Punched Paper	5,000	152
		AS	13"		20,000	695

- Packing type can be modified after discussion.
- (\*) Wide Terminal Type
- (\*\*) Metal Type Ultra Low ohm

The specifications and designs contained herein may be subject to change without notice. Please contact our sales representatives or product engineers before order.

Product Characteristic data Notes

General\_Standard Standard(RC)

General\_Standard Reverse(RCB)

Array Type Resistor Flat(RF, RM)

Array Type Resistor Concave(RN, RM, RK)

Array Type Resistor Convex(RP)

Current Sensing Resistor Low ohms(RUT)

Current Sensing Resistor Ultra Low ohms(RU, RUK)

Current Sensing Resistor Wide Terminal(RJ)

Metal\_CSR Metal Plate\_Clad(RLP,RLC)

High Power Resistor General(RCW)

High Voltage Chip Resistor (RCV)

Anti-Sulfur Resistor General, Array(RCS, RFS, RPS)

Lead free Chip Resistor General, Array, AntiSulfur

Center Common Array 3-Terminal Array(RFT)

Characteristics Performance

### Packaging

Standard Resistance Value

Electrical & Mechanical Caution

Process of Mounting Soldering, Design

Caution of Application

# Standard Resistance Value

## Tolerance Code Table

Tolerance Code	D	F	G	J	K	M
Digit Number	4 digit			3 digit		
IEC-Code System	E-192	E96	E-48	E-24	E-12	E-6
Specification	± 0.5%	± 1%	± 2%	± 5%	± 10%	± 0.20%

## Significant Figure of Resistance Value

E-192	E-96	E-48	E-24	E-192	E-96	E-48	E-24	E-192	E-96	E-48	E-24	E-192	E-96	E-48	E-24
100	100	100	10	178	178	178	18	316	316	316		562	562	562	56
101				180				320				569			
102	102			182	182			324	324			576	576		
104				184				328				583			
105	105	105		187	187	187		332	332	332	33	590	590	590	
106				189				336				597			
107	107			191	191			340	340			604	604		
109				193				344				612			
110	110	110	11	196	196	196		348	348	348		619	619	619	
111				198				352				626			62
113	113			200	200		20	357	357			634	634		
114				203				361			36	642			
115	115	115		205	205	205		365	365	365		649	649	649	
117				208				370				657			
118	118			210	210			374	374			665	665		
120			12	213				379				673			
121	121	121		215	215	215		383	383	383		681	681	681	68
123				218				388				690			
124	124			221	221		22	392	392		39	698	698		
126				223				397				706			
127	127	127		226	226	226		402	402	402		715	715	715	
129				229				407				723			
130	130		13	232	232			412	412			732	732		
132				234				417				741			
133	133	133		237	237	237		422	422	422		750	750	750	75
135				240			24	427				759			
137	137			243	243			432	432		43	768	768		
138				246				437				777			
140	140	140		249	249	249		442	442	442		787	787	787	
142				252				448				796			
143	143			255	255			453	453			806	806		
145				258				459				816			
147	147	147		261	261	261		464	464	464		825	825	825	82
149				264				470			47	835			
150	150		15	267	267			475	475			845	845		
152				271			27	481				856			
154	154	154		274	274	274		487	487	487		866	866	866	
156				277				493				876			
158	158			280	280			499	499			887	887		
160			16	284				505				898			
162	162	162		287	287	287		511	511	511	51	909	909	909	
164				291				517				920			91
165	165			294	294			523	523			931	931		
167				298				530				942			
169	169	169		301	301	301	30	536	536	536		953	953	953	
172				305				542				965			
174	174			309	309			549	549			976	976		
175				312				556				988			

### Example

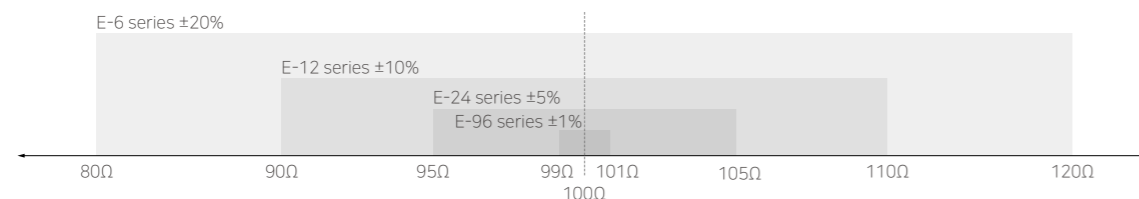

# Electrical & Mechanical Caution

## Precautions and Application Restrictions

### Precautions for Product Safety

- The products are designed and produced for general electronic devices applications. User must contact our sales in-charge before using our products, if there is a risk to occur critical issues, such as casualties due to breakdown or malfunction of devices from application on products demanding high reliability or other safety devices, also for complicated products such as medical equipment, transportation equipment, an aircraft/ spacecraft, an atomic energy controller, a fuel controller, automobile equipment, military equipment, disaster/ crime preventive equipment.
- The products are designed for use in the standard environment. Do not use products in specific environment that can affect a product performance. If you need to use products in the following conditions, please contact our sales in-charge in advance.
  - Various types of liquid including water, oil, organic solvent and other chemicals.
  - Direct sunlight, outdoors, or atmosphere with an amount of dusts.
  - An amount of corrosive gases such as sea breeze, Cl<sub>2</sub>, H<sub>2</sub>S, NH<sub>3</sub>, SO<sub>2</sub>, NO<sub>2</sub>, and etc.
  - Strong static electricity or electromagnetic waves
  - Heat-producing components or inflammable materials are close.
  - A resistor is sealed or coated with materials such as synthetic resin, and etc.
  - Water or water-soluble detergent is used for cleaning free soldering or flux coating after
  - Condensation phenomenon occurs on the object.
  - Out of the range from -55 °C to +155(125) °C
- The products have no radiation resistance.
- It is a must to notify the person in charge of sales of issues on product safety at any time. In addition, a regular monitor for product safety should be conducted by customers.

### Precautions regarding the use of products

- Product characteristics must be evaluated on a board mounted.
- When transitory load is used in which short-time load is applied such as pulse, a resistor should be tested on a board mounted. If load is higher than rated voltage under the load conditions at continuous steps, it causes damages on characteristics or reliability of the resistor. Therefore, when load exceed the rated voltage, it is not allowed to apply.
- It is not recommended to use halogen products such as chlorine (Cl), bromine (Br), etc. or fluxes that are highly active due to the residue that is able to affect the characteristics or reliability of a resistor.
- Be careful with the soldering condition to avoid the Ag-solder penetration problems.
- When soldering manually, do not touch a resistor body with the edge of soldering iron directly. When working with a soldering iron at high temperature, please be done with the work as quick as possible.
- Physical shocks to the resistor can cause the breaking of protective layers of the product and affect its characteristic adversely. Therefore, use caution when picking and moving Chip-R with hard instruments such as metal tweezers in order to avoid damages on a resistor or degradation of product performance degradation.
- Do not soak the resistor in a solvent for a long time. Also, the effect of solvent must be checked prior to use.
- Place products carefully to keep the standard temperature range in the category, otherwise increasing temperature caused by adjacent heat-generating components can exceed the temperature range. In addition, do not place or install heat-emitting components or flammable materials such as plastic coating wires near these products.
- Safety can be guaranteed only when average power is lower than rated power, and if power exceeding the rated power is applied, please make sure to make an inquire on surge voltage or a current waveform for a short time.

Product Characteristic data Notes

General\_Standard Standard(RC)

General\_Standard Reverse(RCB)

Array Type Resistor Flat(RF, RM)

Array Type Resistor Concave(RN, RM, RK)

Array Type Resistor Convex(RP)

Current Sensing Resistor Low ohms(RUT)

Current Sensing Resistor Ultra Low ohms(RU, RUK)

Current Sensing Resistor Wide Terminal(RJ)

Metal\_CSR Metal Plate\_Clad(RLP,RLC)

High Power Resistor General(RCW)

High Voltage Chip Resistor (RCV)

Anti-Sulfur Resistor General, Array(RCS, RFS, RPS)

Lead free Chip Resistor General, Array, AntiSulfur

Center Common Array 3-Terminal Array(RFT)

Characteristics Performance

Packaging

Standard Resistance Value

Electrical & Mechanical Caution

Process of Mounting Soldering, Design

Caution of Application

# Electrical & Mechanical Caution

■ Others

- 1) The product specifications are subject to change, modify or suspend at any time without prior notice by our company. Hence, it is a must to get approval of the product specifications before making orders for products. For more inquires on the product specifications, please contact our sales in-charge or engineer (AE).
- 2) Without our permission, any copies, duplications, use or transmission of contents or information contained in this specification (catalog) for any purpose are prohibited.
- 3) No responsibility shall be held for any claims, disputes, damages or liabilities arising from or related to the misuse of the Products and or information contained in this Specification (Catalog). In addition, regarding the use of the products and information contained in this Specification (Catalog), no liability shall be held for any claims, disputes, damages or liabilities relating to our or any third party 's intellectual property rights or other related rights.
- 4) Bilateral discussions shall be required in case there are unmarked or uncertain parts in the specification (catalog).

## Failure Mechanism

■ Failures caused by overload stress

- 1) Open failure occurs due to the burnt resistor from remaining area of the resistor after trimming. The change in R-values over time is as shown in the graph below.

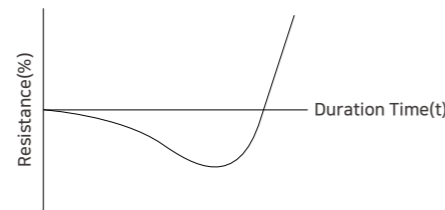

- 2) When overvoltage is continuously applied, heat generated by a resistor destroys glass insulation R so that R-value can decrease at the initial stage. If overvoltage is still applied after the decrease o R-value, a metal conductor is destroyed so that R-value can increase. In a result, open failure occurs at the end.  
\* (R = resistance / R-value = resistance-value)
- 3) Overvoltage refers to the voltage higher than rated voltage.

■ Failures caused by (EOS) Electric Overstress

- 1) EOS is a phenomenon in which R-value decreases or destroys due to destroyed insulation resistance since overload is applied for a very short time (ns) compared to overload stress.
- 2) Overvoltage refers to a voltage in kilovolts(KV) is applied for Nano second(ns).
- 3) Characteristics of EOS overvoltage are inversely proportional to the distance between electrodes of a resistor, thus the use of large size products can minimize EOS effects.

■ Failures caused by pulse

- 1) Since guaranteed power characteristics are varied with times applying to pulses, the change in the guaranteed power characteristics should be marked in a graph so that a developer can refer to it.
- 2) There are products for anti-pulse, and products only for circuit with pulses applied must be used. A pulse graph is not provided for general products, but does for anti-pulse products.

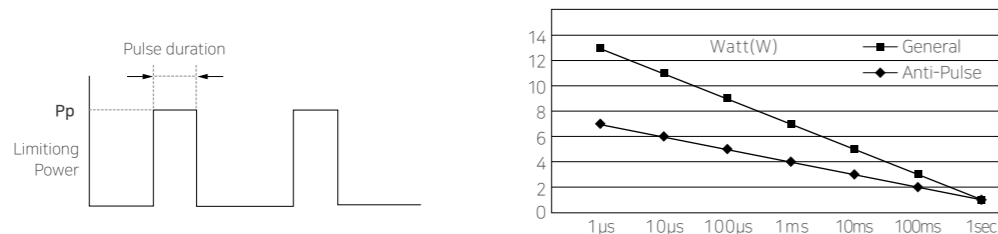

■ Vibration

- 1) Vibrations, shock types and resonance status must be checked.
- 2) Mount a chip resistor to prevent resonance occurrence and any effects on the terminal should not be allowed.

■ Shock

- 1) Mechanical shocks due to a drop may cause not only damages or cracks on a chip resistor, and but also a degradation of its quality and reliability. Thus, it is a must not to use dropped products.
- 2) When stacking or handling substrates, use caution for the edge of other substrates to prevent shocks, cracks or other damages on the Chip.

■ Voltage Coefficient of Resistance : VCR

- 1) In case micro defects (foreign matters, void) are inside of the resistor, electric current cannot be applied at low voltage but an increase of voltage allows the electric current to be applied.
- 2) Therefore, defects can be caused by the difference of R-value by voltage affects measurement.
- 3) A formula and a graph to check VCR characteristics are as follows.

$$V.C.R(ppm / v) = \left(\frac{R_2 - R_1}{R_1}\right) \times \left(\frac{1}{V_2 - V_1}\right) \times 10^6$$

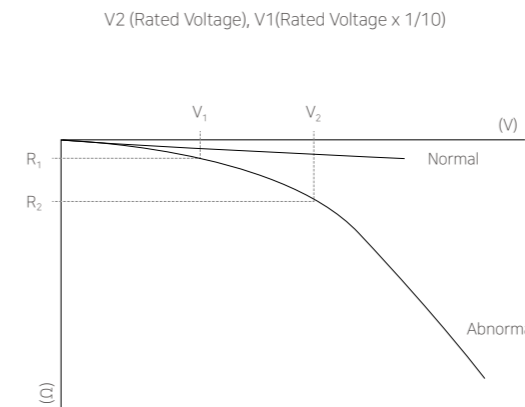

Product Characteristic data Notes

General\_Standard Standard(RC)

General\_Standard Reverse(RCB)

Array Type Resistor Flat(RF, RM)

Array Type Resistor Concave(RN, RM, RK)

Array Type Resistor Convex(RP)

Current Sensing Resistor Low ohms(RUT)

Current Sensing Resistor Ultra Low ohms(RU, RUK)

Current Sensing Resistor Wide Terminal(RJ)

Metal\_CSR Metal Plate\_Clad(RLP,RLC)

High Power Resistor General(RCW)

High Voltage Chip Resistor (RCV)

Anti-Sulfur Resistor General, Array(RCS, RFS, RPS)

Lead free Chip Resistor General, Array, AntiSulfur

Center Common Array 3-Terminal Array(RFT)

Characteristics Performance

Packaging

Standard Resistance Value

Electrical & Mechanical Caution

Process of Mounting Soldering, Design

Caution of Application

# Process of Mounting Soldering

## Mounting

### ■ Mounting position

It is recommended to locate the major axis of chip resistor in parallel to the direction in which the stress is applied.

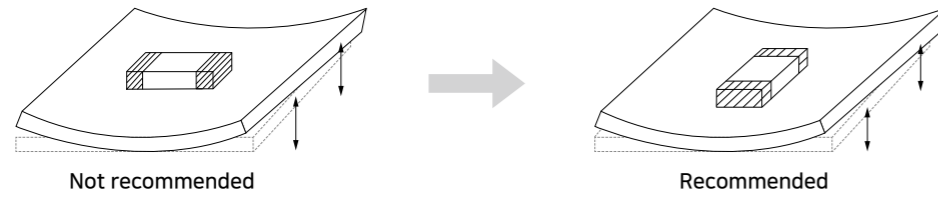

### ■ Cautions during mounting near the cutout

Please take the following measures to effectively reduce the stress generated from the cutting of PCB. Select the mounting location shown below, since the mechanical stress is affected by a location and a direction of chip resistor mounted near the cutting line.

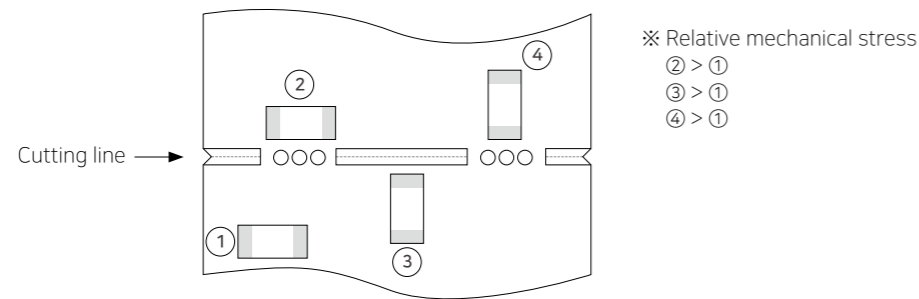

### ■ Cautions during mounting near screw

If chip resistor is mounted near a screw hole, the board deflection may be occurred by screw torque. Mount chip resistor as far from the screw holes as possible.

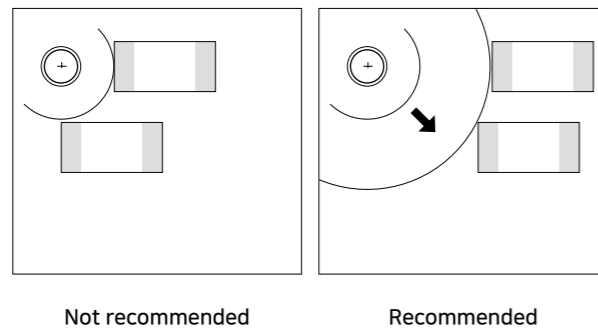

## Caution before Mounting

- It is recommended to store and use chip resistor in a reel. Do not re-use chip resistor that was isolated from the reel.
- Check the capacitance characteristics under actual applied voltage.
- Check the mechanical stress when actual process and equipment is in use.
- Check the rated capacitance, rated voltage and other electrical characteristics before assembly.
- Heat treatment must be done prior to measurement of capacitance.
- Check the solderability of chip resistor that has passed shelf life before use.
- The use of Sn-Zn based solder may deteriorate the reliability of chip resistor.

## Cautions during Mounting with Mounting (pick-and-place) Machines

### ■ Mounting Head Pressure

Excessive pressure may cause cracks in chip resistor. It is recommended to adjust the nozzle pressure within the maximum value of 300gf. Additional conditions must be set for both thin film and special purpose chip resistor.

### ■ Bending Stress

When using a two-sided substrate, it is required to mount chip resistor on one side first. Before mounting on the other side due to the bending of the substrate caused by the mounting head. Support the substrate as shown in the picture below when chip resistor is mounted on the other side. If the substrate is not supported, bending of the substrate may cause cracks in chip resistor.

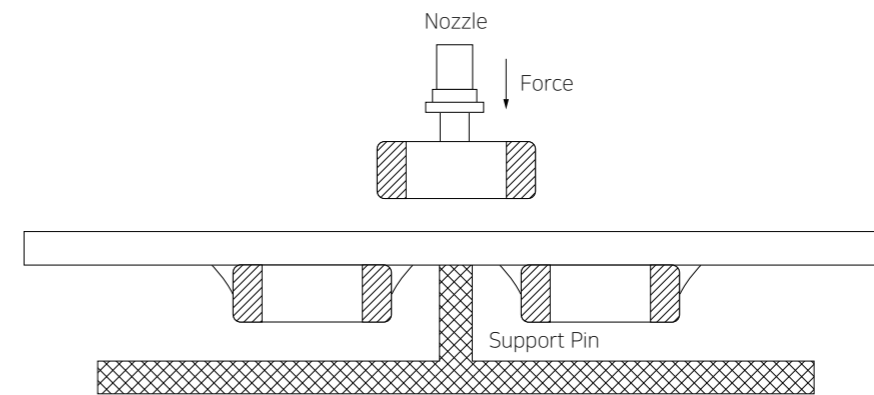

### ■ Suction nozzle

Dust accumulated in a suction nozzle and suction mechanism can impede a smooth movement of the nozzle. This may cause cracks in chip resistor due to the excessive force during mounting. If the mounting claw is worn out, it may cause cracks in chip resistor due to the uneven force. During positioning. A regular inspection such as maintenance, monitor and replacement for the suction nozzle and mounting claw should be conducted.

Product Characteristic data Notes

General\_Standard Standard(RC)

General\_Standard Reverse(RCB)

Array Type Resistor Flat(RF, RM)

Array Type Resistor Concave(RN, RM, RK)

Array Type Resistor Convex(RP)

Current Sensing Resistor Low ohms(RUT)

Current Sensing Resistor Ultra Low ohms(RU, RUK)

Current Sensing Resistor Wide Terminal(RJ)

Metal\_CSR Metal Plate\_Clad(RLP, RLC)

High Power Resistor General(RCW)

High Voltage Chip Resistor (RCV)

Anti-Sulfur Resistor General, Array(RCS, RFS, RPS)

Lead free Chip Resistor General, Array, AntiSulfur

Center Common Array 3-Terminal Array(RFT)

Characteristics Performance

Packaging

Standard Resistance Value

Electrical & Mechanical Caution

Process of Mounting Soldering, Design

Caution of Application

# Process of Mounting Soldering

## Reflow soldering

Chip resistor is in a direct contact with the dissolved solder during soldering, which may be exposed to potential mechanical stress caused by the sudden temperature change. Therefore, chip resistor may be contaminated by the location movement and flux. For the reason, the mounting process must be closely monitored.

Method		Classification
Reflow soldering	Overall heating	Infrared rays
		Hot plate
		VPS(Vapor phase)
	Local heating	Air heater
		Laser
		Light beam

### Reflow Profile

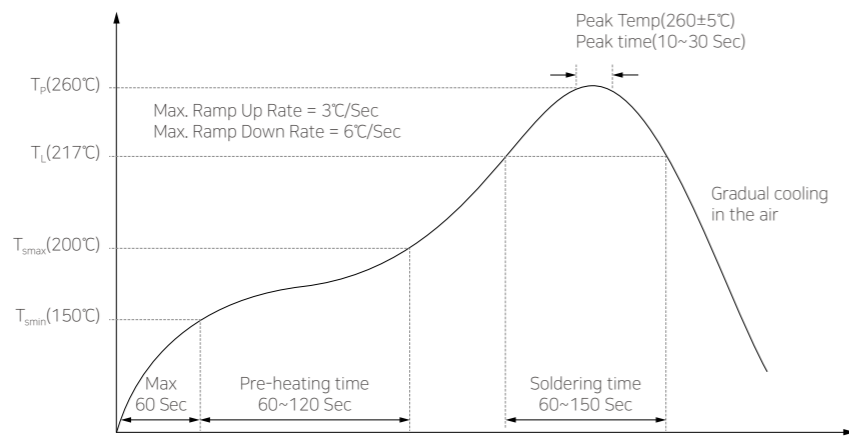

Use caution not to exceed the peak temperature (260°C) and time (30sec) as shown. Pre-heating is necessary for all constituents including the PCB to prevent the mechanical damages on chip resistor. The temperature difference between the PCB and the component surface must be kept to the minimum.

As for reflow soldering, it is recommended to keep the number of reflow soldering to less than three times. Please check with us when the number of reflow soldering needs to exceed three times. Care must be exercised especially for the ultra-small size, thin film and high capacitance chip resistor as they can be affected by thermal stress more easily.

### Reflow temperature

The following quality problem may occur when chip resistor is mounted with a lower temperature than the reflow temperature recommended by a solder manufacturer. The specified peak temperature must be maintained after taking into consideration the factors such as the placement of peripheral constituent and the reflow temperature.

- Drop in solder wettability
- Solder voids
- Potential occurrence of whisker
- Drop in adhesive strength
- Drop in self-alignment properties
- Potential occurrence of tombstones

### Cooling

Natural cooling with air is recommended.

### Optimum solder flux for reflow soldering

- Overly the thick application of solder pastes results in an excessive solder fillet height. This makes chip resistor more vulnerable to the mechanical and thermal stress from the board, which may cause cracks in chip resistor.
- Too little solder paste results in a lack of the adhesive strength, which may cause chip resistor to isolate from PCB
- Check if solder has been applied uniformly after soldering is completed.

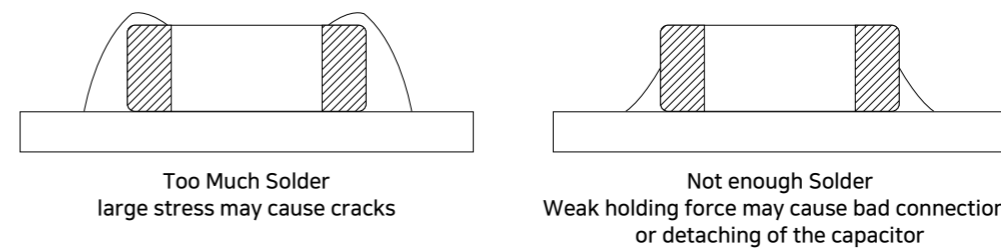

- It is required to design a PCB with consideration of a solder land pattern and its size to apply an appropriate amount of solder to chip resistor. The amount of the solder at the edge may impact directly on cracks in chip resistor.
- The design of a suitable solder land is necessary since the more the solder amount is, the larger the force chip resistor experiences and the higher the chance chip resistor cracks.

Product Characteristic data Notes

General\_Standard Standard(RC)

General\_Standard Reverse(RCB)

Array Type Resistor Flat(RF, RM)

Array Type Resistor Concave(RN, RM, RK)

Array Type Resistor Convex(RP)

Current Sensing Resistor Low ohms(RUT)

Current Sensing Resistor Ultra Low ohms(RU, RUK)

Current Sensing Resistor Wide Terminal(RJ)

Metal\_CSR Metal Plate\_Clad(RLP, RLC)

High Power Resistor General(RCW)

High Voltage Chip Resistor (RCV)

Anti-Sulfur Resistor General, Array(RCS, RFS, RPS)

Lead free Chip Resistor General, Array, AntiSulfur

Center Common Array 3-Terminal Array(RFT)

Characteristics Performance

Packaging

Standard Resistance Value

Electrical & Mechanical Caution

Process of Mounting Soldering, Design

Caution of Application

# Process of Mounting Soldering

## Flow soldering

### Flow profile

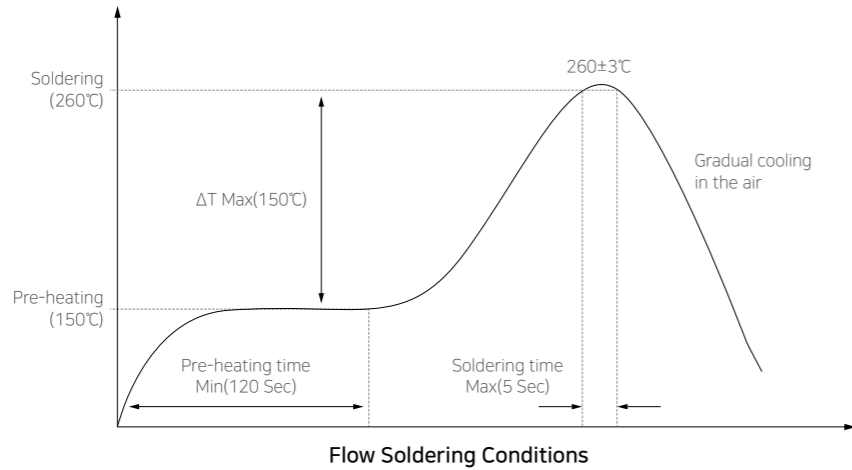

Take caution not to exceed peak temperature (260°C) and time (5sec) as shown. Flow soldering is recommended only for 0603(inch) size or bigger sizes. It must be consulted with our sales representatives or engineers before using a special models.

### Caution before Flow soldering

When a sudden heat is applied to chip resistor, the mechanical rigidity of chip resistor is Deteriorated by the internal deformation of chip resistor. Preheating all the constituents including PCB is required to prevent the mechanical damages on chip resistor. The temperature difference between the solder and the surface of chip resistor must be kept to the minimum.

If the flow time is too long or the flow temperature is too high, the adhesive strength with PCB may be deteriorated by the leaching phenomenon of the outer termination, or the capacitance value may be dropped by weak adhesion between the internal termination and the outer termination.

## Soldering Iron

Manual soldering can pose a great risk on creating thermal cracks in chip resistor. The high temperature soldering iron tip may come into a direct contact with the ceramic body of chip resistor due to the carelessness of an operator. Therefore, the soldering iron must be handled carefully, and close attention must be paid to the selection of the soldering iron tip and to temperature control of the tip.

### How to use a soldering iron

- In order to minimize damages on MILL, preheating chip resistor and PCB is necessary. A hot plate and a hot air type preheater should be used for preheating
- Do not cool down chip resistor and PCB rapidly after soldering.
- Keep the contact time between the outer termination of chip resistor and the soldering iron as short as possible. Long soldering time may cause problems such as adhesion deterioration by the leaching phenomenon of the outer termination.

Variation of Temp.	Soldering Temp.(°C)	Pre-heating Time(sec)	Soldering Time(sec)	Cooling Time(sec)
$\Delta T \leq 130$	$300 \pm 10^\circ\text{C max}$	$\geq 60$	$\leq 4$	-

\* Control  $\Delta T$  in the solder iron and preheating temperature.

Condition of Iron facilities		
Wattage	Tip diameter	Soldering time
20W max	3mm max	4sec max

\* Caution - Iron tip should not contact with ceramic body directly  
Lead-free solder: Sn-3.0Ag-0.5CU

### How to use a spot heater

Compared to local heating using a solder iron, heat by a spot heater heats the overall chip resistor and the PCB, which is likely to lessen the thermal shocks. For a high density PCB, a spot heater can prevent the problem to connect between a solder iron and chip resistor directly.

- If the distance from the air nozzle outlet to chip resistor is too close, chip resistor may be cracked due to the thermal stress. Follow the conditions set in the table below to prevent this problem.
- The spot heater application angle as shown in the figure is recommended to create a suitable solder fillet shape.

Distance	5mm $\leq$
Hot Air Application angle	45°C
Hot Air Temperature Nozzle Outlet	400°C $\geq$
Application Time	10s $>$

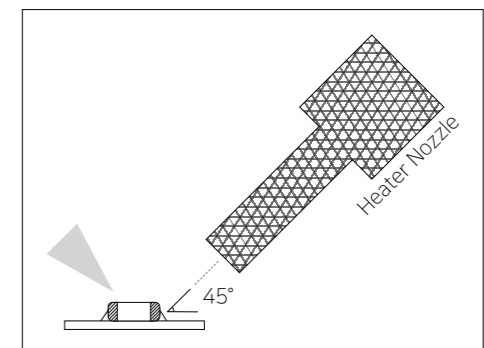

Product Characteristic data Notes

General\_Standard Standard(RC)

General\_Standard Reverse(RCB)

Array Type Resistor Flat(RF, RM)

Array Type Resistor Concave(RN, RM, RK)

Array Type Resistor Convex(RP)

Current Sensing Resistor Low ohms(RUT)

Current Sensing Resistor Ultra Low ohms(RU, RUK)

Current Sensing Resistor Wide Terminal(RJ)

Metal\_CSR Metal Plate\_Clad(RLP, RLC)

High Power Resistor General(RCW)

High Voltage Chip Resistor (RCV)

Anti-Sulfur Resistor General, Array(RCS, RFS, RPS)

Lead free Chip Resistor General, Array, AntiSulfur

Center Common Array 3-Terminal Array(RFT)

Characteristics Performance

Packaging

Standard Resistance Value

Electrical & Mechanical Caution

Process of Mounting Soldering, Design

Caution of Application

# Process of Mounting Soldering

## ■ Cautions for re-work

- Too much solder amount will increase the risk of PCB bending or cause other damages.
- Too little solder amount will result in chip resistor breaking loose from the PCB due to the inadequate adhesive strength.
- Check if the solder has been applied properly and ensure the solder fillet has a proper shape.

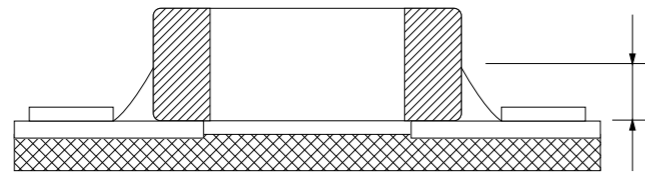

\* Soldering wire below  $\varnothing 0.5\text{mm}$  is required for soldering.

## Cleaning

### ■ In general, cleaning is unnecessary if rosin flux is used.

When acidic flux is used strongly, chlorine in the flux may dissolve into some types of cleaning fluids, thereby affecting the performance of chip resistor. This means that the cleansing solution must be carefully selected and should always be new.

### ■ Cautions for cleaning

chip resistor or solder joint may be cracked with the vibration of PCB, if ultrasonic vibration is too strong during cleaning. When high pressure cleaning equipment is used, test should be done for the cleaning equipment and its process before the cleaning in order to avoid damages on chip resistor.

## Cautions for using electrical measuring probes

- Confirm the position of the support pin or jig when checking the electrical performance of chip resistor after mounting on the PCB.
- Watch for PCB bending caused by the pressure of a test-probe or other equipment.
- If the PCB is bent by the force from the test probe, chip resistor may be cracked or the solder joint may be damaged.
- Avoid PCB flexing by using the support pin on the back side of the PCB.
- Place equipment with the support pin as close to the test-probe as possible.
- Prevent shock vibrations of the board when the test-probe contacts a PCB.

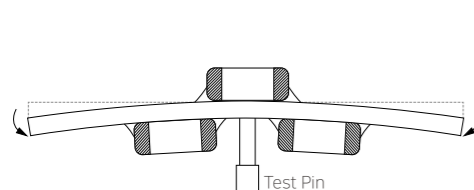

Not recommended

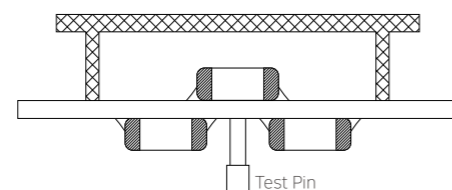

Recommended

## Printed Circuit Board Cropping

- Do not apply any stress to chip resistor such as bending or twisting the board after mounting chip resistor on the PCB.
- The stress as shown may cause cracks in chip resistor when cutting the board.
- Cracked chip resistor may cause degradation to the insulation resistance, thereby causing short circuit.
- Avoid these types of stresses applied to chip resistor.

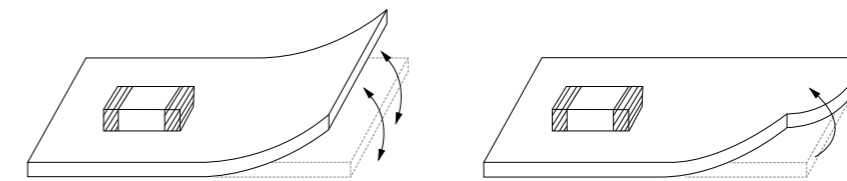

Bending

Twisting

### ■ Cautions for cutting PCB

Check a cutting method of PCB in advance. The high density board is separated into many individual boards after the completion of soldering. If the board is bent or deformed during separation, chip resistor may be cracked. Carefully select a separation method that minimizes the deformation of the PCB.

## Assembly Handling

### ■ Cautions for PCB handling

Hold the edges of the board mounted with chip resistor with both hands since holding with one hand may bend the board. Do not use dropped boards, which may degrade the quality of chip resistor.

### ■ Mounting other components

Pay attention to the following conditions when mounting other components on the back side of The board after chip resistor has been mounted on the front side. When the suction nozzle is placed too close to the board, board deflection stress may be applied to chip resistor on the back side, resulting in cracks in chip resistor. Check if proper value is set on each chip mounter for a suction location, a mounting gap and a suction gap by the thickness of components.

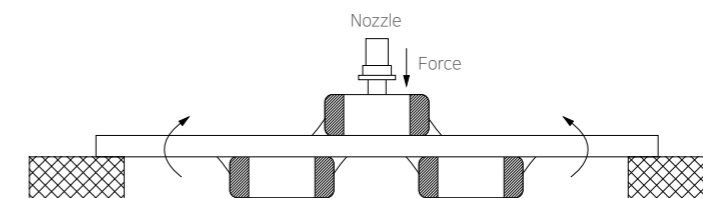

# Process of Mounting Soldering

## ■ Board mounting with leads

If the board is bent when inserting components (transformer, IC, etc.) into it, chip resistor or solder joint may be cracked

Pay attention to the followings

- 1) Reduce the stress on the board during insertion by increasing the size of the lead insertion hole.
- 2) Insert components with leads into the board after fixing the board with support pins or a dedicated jig.
- 3) Support the bottom side of the board to avoid bending the board.
- 4) Check the status of the height of each support pin regularly when the support pins are used.

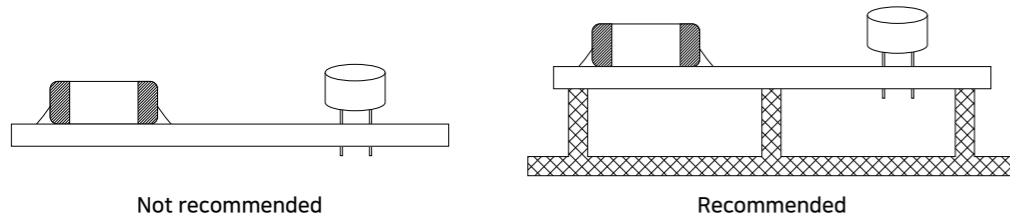

## ■ Socket and / or connector attach / detach

Since the insertion or removal from sockets and connectors may cause the board to bent, make sure that chip resistor mounted on the board should not be damaged in this process.



## ■ Fastening screw

When attaching a shield on a board, the board may be bent during a screw tightening work. Pay attention to the following conditions before performing the work.

- 1) Plan the work to prevent the board from bending.
- 2) Use a torque driver to prevent over-tightening of the screw.
- 3) Since the board may be bent by soldering, use caution in tightening the screw.

## Adhesive selection

Pay attention to the following if an adhesive is used to position chip resistor on the board before soldering.

### ■ Requirements for Adhesives

- 1) They must have enough adhesive strength to prevent chip resistor from slipping or moving during the handling the board.
- 2) They must maintain their adhesive strength when exposed to soldering temperatures.
- 3) They should not spread when applied to the PCB.
- 4) They should have a long pot life.
- 5) They should hardened quickly.
- 6) They should not corrode the board or chip resistor materials.
- 7) They should be an insulator type that does not affect the characteristic of chip resistor.
- 8) They should be non-toxic, not harmful, and particularly safe when workers touch the adhesives.

### ■ Caution before Applying Adhesive

Check the correct application conditions before attaching chip resistor to the board with an adhesive. If the dimension of land, the type of adhesives, the amount of coating, the contact surface areas, the curing temperature, or other conditions are not appropriate, it may degrade the chip resistor performance.

### ■ Cautions for selecting Adhesive

Depending on the type of the chosen adhesive, chip resistor insulation resistance may be degraded. In addition, chip resistor may be cracked by the difference in contractile stress caused by the different contraction rate between chip resistor and the adhesive.

### ■ Cautions for the amount of applied adhesive and curing temperature

- 1) The inappropriate amount of the adhesive cause the weak adhesive strength, resulting in the a mounting defect in chip resistor.
- 2) Excessive use of the adhesive may cause a soldering defect, loss of electrical connection, incorrect curing, or slippage of a mounting position, thereby an inflow of the adhesive onto a land section should be avoided.
- 3) If the curing temperature is too high or the curing time is too long, the adhesive strength will be degraded. In addition, oxidation both on the outer termination (Sn) of chip resistor and the surface of the board may deteriorate the solderability.

# Process of Mounting Soldering

## Flux

- The excessive amount of flux generates excessive flux gases which may deteriorate solderability. Therefore, apply the flux thin and evenly as a whole.
- Flux with a high ratio of halogen may oxidize the outer termination of chip resistor, if cleaning is not done properly. Therefore, use flux with a halogen content of 0.1% max.
- Strong acidic flux can degrade the chip resistor performance
- Check the solder quality of chip resistor and the amount of remaining flux surrounding chip resistor after the mounting process.

## Coating

- Crack caused by Coating

A crack may be caused in the chip resistor due to amount of the resin and stress of thermal contraction of the resin during coating process.

During the coating process, the amount of resin and the stress of thermal contraction of the resin may cause cracks in chip resistor

The difference of thermal expansion coefficient between the coating, or a molding resin may cause destruction, deterioration of insulation resistance or dielectric breakdown of chip resistor such as cracks or detachment, etc.

- Recommended Coating material

- 1) A thermal expansion coefficient should be as close to that of chip resistor as possible.
- 2) A silicone resin can be used as an under-coating to buffer the stress.
- 3) The resin should have a minimum curing contraction rate.
- 4) The resin should have a minimum sensitivity (ex. Epoxy resin).
- 5) The insulation resistance of chip resistor can be deteriorated if a high hygroscopic property resin is used in a high humidity condition.
- 6) Do not use strong acid substances due to the fact that coating materials inducing a family of halogen substances and organic acid may corrode chip resistor.

# Design

## Circuit design

When the board is dropped or bent, chip resistor mounted on the board may be short-circuited by the drop in insulation resistance. Therefore, it is required to install safety equipment such as a fuse. To prevent additional accidents when chip resistor is short-circuited, otherwise, electric short and fire may occur. This product is not a safety guaranteed product.

## PCB Design

- Unlike lead type components, SMD type components that are designed to be mounted directly on the board are fragile to the stress. In addition, they are more sensitive to mechanical and thermal stress than lead type components.

- Chip resistor crack by PCB material type

A great difference of the thermal expansion coefficient between PCB and chip resistor causes thermal expansion and contraction, resulting in cracks in chip resistor. Even though chip resistor is mounted on a board with a fluorine resin or on a single-layered glass epoxy, cracks in chip resistor may occur.

## Design system evaluation

- Evaluate the actual design with chip resistor to make sure there is no functional issue or violation of specifications of the finished goods.
- Surge resistance must be evaluated since the excessive surge caused by the inductance of the actual system may apply to chip resistor.
- Note the actual chip resistor size and the termination shape.

## Land dimension

The recommended land dimension is determined by evaluating the actual SET and a board

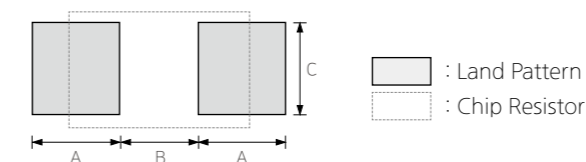

(Unit: mm)

Size	Chip Size(mm)	A	B	2A+B	C
0402	0.40 × 0.20	0.17	0.20	0.54	0.18
0603	0.60 × 0.30	0.37	0.28	1.02	0.29
1005	1.00 × 0.50	0.60	0.50	1.70	0.50
1608	1.60 × 0.80	0.80	0.80	2.40	0.80
2012	2.00 × 1.20	0.90	1.40	3.20	1.20
3216	3.20 × 1.60	1.30	1.80	4.40	1.50
3225	3.20 × 2.50	1.30	1.80	4.40	2.40
5025	5.20 × 2.50	1.40	3.30	6.10	2.40
6432	6.40 × 3.20	1.40	4.60	7.40	3.00

Product Characteristic data Notes

General\_Standard Standard(RC)

General\_Standard Reverse(RCB)

Array Type Resistor Flat(RF, RM)

Array Type Resistor Concave(RN, RM, RK)

Array Type Resistor Convex(RP)

Current Sensing Resistor Low ohms(RUT)

Current Sensing Resistor Ultra Low ohms(RU, RUK)

Current Sensing Resistor Wide Terminal(RJ)

Meta\_CSR Metal Plate\_Clad(RLP, RLC)

High Power Resistor General(RCW)

High Voltage Chip Resistor (RCV)

Anti-Sulfur Resistor General, Array(RCS, RFS, RPS)

Lead free Chip Resistor General, Array, AntiSulfur

Center Common Array 3-Terminal Array(RFT)

Characteristics Performance

Packaging

Standard Resistance Value

Electrical & Mechanical Caution

Process of Mounting Soldering, Design

Caution of Application

# Others

## Storage environment

### ■ Recommendation for temperature/humidity

Even taping and packaging materials are designed to endure a long-term storage, they should be stored with a temperature of 0~40°C and an RH of 0~70% otherwise, too high temperatures or humidity may deteriorate the quality of the product rapidly.

As oxidization is accelerated when relative humidity is above 70%RH, the lower the humidity is, the better the solderability is.

As the temperature difference may cause dew condensation during the storage of the product, it is a must to maintain a temperature control environment

### ■ Shelf life

An allowable storage period should be within 6 months from the outgoing date of delivery in consideration of solderability.

It can be stored for a long time in vacuum at room temperature, but if vacuum condition is not available, it is recommended to be stored in a dry condition inside desiccator.

As for products in storage over 6 months, please check solderability before use.

## Corrosion

### ■ Caution for corrosion environment

As corrosive gases may deteriorate the solderability of chip resistor outer termination, it is a must

To store chip resistor in an environment without gases. chip resistor that is exposed to corrosive

Gases may cause its quality issues due to the corrosion of plating layers and the penetration of moisture.

Particularly, in hydrogen sulfide, sulfur dioxide, chlorine, ammonia gas atmosphere, the electrode of resistor can be corroded and defects may occur. So, general products aside from special products, such as ASR, must not be used in these conditions.

If failure occurs when using in the mentioned gas environment, our company is not responsible.

### ■ If external electrode of chip resistor is water-logged, defects due to corrosion may occur.

## Equipment in operation

### ■ Do not touch chip resistor directly with bare hands to prevent an electric shock or damage.

### ■ The termination of chip resistor shall not be contacted with a conductive object (short -circuit). Do not expose chip resistor to conductive liquid containing acidic or alkali material.

### ■ Do not use the equipment in the following conditions.

- 1) Exposure to water or oil
- 2) Exposure to direct sunlight
- 3) Exposure to Ozone or ultra-violet radiation.
- 4) Exposure to corrosive gas (e.g. hydrogen sulfide, sulfur dioxide, chlorine, ammonia gas)
- 5) Exposure to vibration or mechanical shock exceeding specified limit
- 6) Exposure to high humidity

### ■ If the equipment starts generating any smoke, fire or smell, immediately switch it off or unplug from the power source. If the equipment is not switched off or unplugged, serious damage may occur due to the continuous power supply. Please be careful with the high temperature in this condition.

## Waste treatment

In case of scrapping chip resistor, it is incinerated or buried by a licensed industrial waste company.

When scrapping chip resistor, it is recommended to incinerate or bury the scrapping by a licensed industrial waste company.

## Operating temperature

The operating temperature limit is determined by the specification of each models.

- Do not use chip resistor over the maximum operating temperature. Pay attention to equipment's temperature distribution and the seasonal fluctuation of ambient temperature.
- The surface temperature of chip resistor cannot exceed the maximum operating temperature including self-heating effects.

## Transportation

The performance of chip resistor may be affected by transportation conditions.

### ■ Chip resistor shall be protected from excessive temperature, humidity and a mechanical force during transportation.

During transportation, the cartons shall not be deformed and the inner packaging shall be protected from excessive external forces.

### ■ Do not apply excessive vibrations, shocks or excessive forces to chip resistor.

- 1) If excessive mechanical shock or stress are applied, chip resistor's ceramic body may crack.
- 2) When the surface of chip resistor is hit with the sharp edge of an air driver, a soldering iron, or a tweezer, etc, chip resistor may crack or become short-circuited.

### ■ Chip resistor may crack and become non-functional due to the excessive shocks or dropping during transportation.

## Notice

Some special products are excluded from this document.

Please be advised that this is a standard product specification for a reference only.

We may change, modify or discontinue the product specifications without notice at any time.

So, you need to approve the product specifications before placing an order.

Should you have any question regarding the product specifications, please contact our sales personnel or application engineers.

Product Characteristic data Notes

General\_Standard Standard(RC)

General\_Standard Reverse(RCB)

Array Type Resistor Flat(RF, RM)

Array Type Resistor Concave(RN, RM, RK)

Array Type Resistor Convex(RP)

Current Sensing Resistor Low ohms(RUT)

Current Sensing Resistor Ultra Low ohms(RU, RUK)

Current Sensing Resistor Wide Terminal(RJ)

Metal\_CSR Metal Plate\_Clad(RLP,RLC)

High Power Resistor General(RCW)

High Voltage Chip Resistor (RCV)

Anti-Sulfur Resistor General, Array(RCS, RFS, RPS)

Lead free Chip Resistor General, Array, AntiSulfur

Center Common Array 3-Terminal Array(RFT)

Characteristics Performance

Packaging

Standard Resistance Value

Electrical &amp; Mechanical Caution

 **Process of Mounting Soldering, Design**

Caution of Application

# Caution of Application

## Disclaimer

The products listed as follows are NOT designed and manufactured for any use and applications set forth below. Please note that any misuse of the products deviating from products specifications or information provided in this Spec sheet may cause serious property damages or personal injury.

- ① Aerospace/Aviation equipment
- ② Automotive of Transportation equipment (vehicles, trains, ships, etc)
- ③ Military equipment
- ④ Atomic energy-related equipment
- ⑤ Undersea equipment
- ⑥ Any other applications with the same as or similar complexity or reliability to the applications

## Limitation





Please contact us with usage environment information such as voltage, current, temperature, or other special conditions before using our products for the applications listed below. The below application conditions require especially high reliability products to prevent defects that may directly cause damages or loss to third party's life, body or property.

If you have any questions regarding this 'Limitation', you should first contact our sales personnel or application engineers.

- ① Medical equipment
- ② Disaster prevention/crime prevention equipment
- ③ Power plant control equipment
- ④ Traffic signal equipment
- ⑤ Data-processing equipment
- ⑥ Electric heating apparatus, burning equipment
- ⑦ Safety equipment
- ⑧ Any other applications with the same as or similar complexity or reliability to the applications

## Quality System Certification List

Table 1: Certification list of Samsung Factory

Certification	Section	Philippine
 <p><b>IATF 16949</b></p>	Authority	BSI
	Number	IATF_91430-005
	Date	2021-08-17
	Validity	2024-08-16
 <p><b>ISO 14001</b></p>	Authority	BSI
	Number	EMS 77354
	Date	2021-07-13
	Validity	2024-07-12
 <p><b>ISO 45001</b></p>	Authority	BSI
	Number	OHS 568723
	Date	2019-10-14
	Validity	2022-10-13
 <p><b>QC 080000</b></p>	Authority	IECQ
	Number	IECQ-H ULTW 10.0016
	Date	2019-07-02
	Validity	2022-07-04

Product Characteristic data Notes

General\_Standard Standard(RC)

General\_Standard Reverse(RCB)

Array Type Resistor Flat(RF, RM)

Array Type Resistor Concave(RN, RM, RK)

Array Type Resistor Convex(RP)

Current Sensing Resistor Low ohms(RUT)

Current Sensing Resistor Ultra Low ohms(RU, RUK)

Current Sensing Resistor Wide Terminal(RJ)

Metal\_CSR Metal Plate\_Clad(RLP, RLC)

High Power Resistor General(RCW)

High Voltage Chip Resistor (RCV)

Anti-Sulfur Resistor General, Array(RCS, RFS, RPS)

Lead free Chip Resistor General, Array, AntiSulfur

Center Common Array 3-Terminal Array(RFT)

Characteristics Performance

Packaging

Standard Resistance Value

Electrical & Mechanical Caution

Process of Mounting Soldering, Design

Caution of Application

# Component sales offices

## Head Office

150, Maeyeong-ro, Yeongtong-gu, Suwon-si, Gyeonggi-do, Republic of Korea  
**Tel** +82-31-210-5114 (Main Number)

## America

**San Jose**  
 Samsung Electro Mechanics America Inc. (HQ)  
 3655 N 1st street, San Jose CA 95134, U.S.A.  
**Tel** +1-408-544-5454

**San Diego**  
 Samsung Electro Mechanics America Inc. (San Diego office)  
 5405 Morehouse Drive, Suite #220 San Diego CA 92121 USA  
**Tel** +1-858-263-3024

**Phoenix**  
 Samsung Electro Mechanics America Inc. (Phoenix Office)  
 4505 E Chandler Blvd suite #105, Phoenix, AZ, 85048, U.S.A.  
**Tel** +1-480-592-0184

**Detroit**  
 Samsung Electro Mechanics America Inc. (Detroit Office)  
 4121 N Atlantic Blvd Auburn Hills Michigan 48326, U.S.A.

## Europe

**Frankfurt**  
 Samsung Electro-Mechanics GmbH. (HQ)  
 Koelner Str. 12, 65760 Eschborn, Germany.  
**Tel** +49-6196-66-3300

**Munich**  
 Samsung Electro-Mechanics GmbH. (Munich Office)  
 Reichenbachstrasse 2, 85737 Ismaning, Germany.  
**Tel** +49-6196-66-7237

**Stuttgart**  
 Samsung Electro-Mechanics GmbH. (Stuttgart Office)  
 Leitzstrasse 45, 70469 Stuttgart, Germany.  
**Tel** +49-7114-906-6281

**Helsinki**  
 Samsung Electro-Mechanics GmbH. (Helsinki Office)  
 Keilaranta 1, 02150 Espoo, Finland.  
**Tel** +35-898-53-1132

## Asia

**Shenzhen**  
 Samsung Electro-Mechanics (ShenZhen) Co.,Ltd.(HQ)  
 14F, Tower A, SCC Building, Junction of Houhai Blvd. and Haide 1st Rd., Nanshan Dist., Shenzhen City, China.  
**Tel** +86-755-8608-5574

**Shanghai**  
 Samsung Electro-Mechanics Co.,Ltd. (Shanghai Branch)  
 13F Room 1301-1302, Tower B, SOHO Zhongshan Building, No.1065 Zhongshan West Rd., Changning Dist., Shanghai City, China.  
**Tel** +86-21-2501-5803

**Beijing**  
 Samsung Electro-Mechanics Co.,Ltd. (Beijing Branch)  
 21F 2101-3, Samsung Tower, Building 1, Yard31, Jinghui Street,Chaoyang Dist, Beijing City, China.  
**Tel** +86-10-5092-8701

**Taipei**  
 Samsung Electro-Mechanics Co.,Ltd. (Taipei Branch)  
 9F-1, No.399 Rueykuang Rd., Neihu Dist., Taipei City, Taiwan.  
**Tel** +886-2-2656-8351

**Singapore**  
 Samsung Electro-Mechanics Private Limited(HQ)  
 3 Church Street Samsung Hub #23-01 Singapore.  
**Tel** +65-6933-2600

**Penang**  
 Samsung Electro-Mechanics Private Limited(Penang Office)  
 Unit 9-06, Menara Boustead, 39 Jalan Sultan Ahmad Shah, 10050, Georgetown, Penang, Malaysia.  
**Tel** +60-4-818-3912

**New Delhi**  
 Samsung Electro-Mechanics Private Limited(New Delhi Office)  
 G-4, Ground Floor Salcon Aurum Building, Jasola New Delhi-110025, India.  
**Tel** +91-956-005-0310

**Tokyo**  
 Samsung Electro-Mechanics Japan Co., Ltd(HQ)  
 Shinagawa Grand Central Tower 9F, 2-16-4, Kounan, Minato-ku, Tokyo, Japan.  
**Tel** +81-3-6369-6461

# Manufacturing sites

**Suwon Plant (HQ)**  
 150, Maeyeong-ro, Yeongtong-gu, Suwon-si, Gyeonggi-do, Republic of Korea  
**Tel** +82-31-210-5114 (Main Number)

**Busan Plant**  
 333, Noksansaneopjung-ro, Gangseo-gu, Busan, Republic of Korea  
**Tel** +82-31-210-5114 (Main Number)

**China Tianjin**  
 80, Xiaqing road, TEDA west district, Tianjin, China  
**Tel** +86-6686-3333 (1120, 3620)



**Philippines**  
 BLK 5&6 Calamba Premiere International Park Brgy. Batino Calamba, Laguna Philippines  
**Tel** +63-49-508-8300

**SAMSUNG  
ELECTRO-MECHANICS**









## Looking for pricing, stock, or lifecycle information?

Click below to explore more details on WIN SOURCE:

-  [View RP164PJ000CS on WIN SOURCE](#)
-  [Samsung Information](#)

## Optimize Your Supply Chain with WIN SOURCE Solutions

-  Global Sourcing Solution
-  Obsolete Management
-  Cost Control Management
-  Shortage Management
-  Alternative Solution
-  Excess Inventory Management