



**THE DATASHEET OF  
UAQ02C05L01-R0.5**



# DATA SHEET

**ELECTROSTATIC DISCHARGE  
PROTECTION DEVICES**

**INDUSTRIAL / CONSUMER**

UAQ02C05L01-R0.5

RoHS compliant & Halogen free



Product specification—July 04, 2023 V.3



## Electrostatic Discharged Protection Devices (ESD) Data Sheet

### Description

The UAQ02C05L01-R0.5 includes back-to-back TVS diodes fabricated in a proprietary silicon avalanche technology to provide protection for electronic equipment that may experience destructive electrostatic discharge (ESD). This robust diodes can safely absorb repetitive ESD strikes up to the maximum level specified in the IEC61000-4-2 international standard without performance degradation.

The back-to-back configuration provides symmetrical ESD protection for data lines when AC signals are present..



Contact : ±20kV  
Air : ±20kV



### Features

- IEC61000-4-2 ESD 20KV Air, 20KV contact compliance
- SOD882 surface mount package
- Working voltage: 5V
- Low leakage current
- Low operating and clamping voltages
- Lead Free/RoHS compliant
- Flammability rating UL 94V-0
- Meets MSL level 1, per J-STD-020
- Marking: 3L

### Applications

- USB 3.0/USB 2.0
- MHL/MIPI/MDDI
- HDMI, Video Port, eSATA
- Set Top Boxes, Game Consoles
- Smart Phones
- External Storage
- Ultrabooks, Notebooks
- Tablets, eReaders

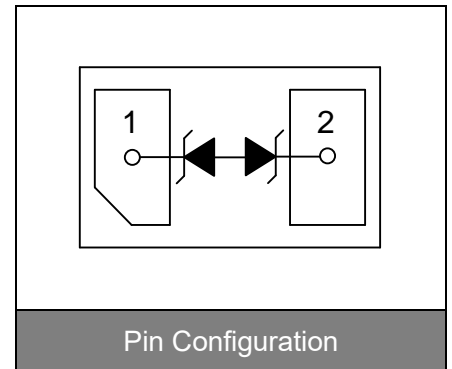

### Maximum Ratings

Rating	Symbol	Value	Unit
ESD voltage (Contact discharge)	$V_{ESD}$	±20	kV
ESD voltage (Air discharge)		±20	
Storage & operating temperature range	$T_{STG}, T_J$	-55~+150	°C

**Electrical Characteristics (T<sub>J</sub>=25°C)**

Parameter	Symbol	Condition	Min.	Typ.	Max.	Unit
Reverse stand-off voltage	V <sub>RWM</sub>				5	V
Reverse breakdown voltage	V <sub>BR</sub>	I <sub>BR</sub> =1mA	6			V
Reverse leakage current	I <sub>R</sub>	V <sub>R</sub> =5V			1	μA
Clamping voltage (tp=8/20μs)	V <sub>C</sub>	I <sub>PP</sub> =3A		20		V
Peak pulse current (tp=8/20μs)	I <sub>PP</sub>				3	A
Off state junction capacitance	C <sub>J</sub>	0Vdc,f=1MHz		0.4	0.5	pF

**Typical Characteristics Curves**

Figure 1. Pulse Waveform

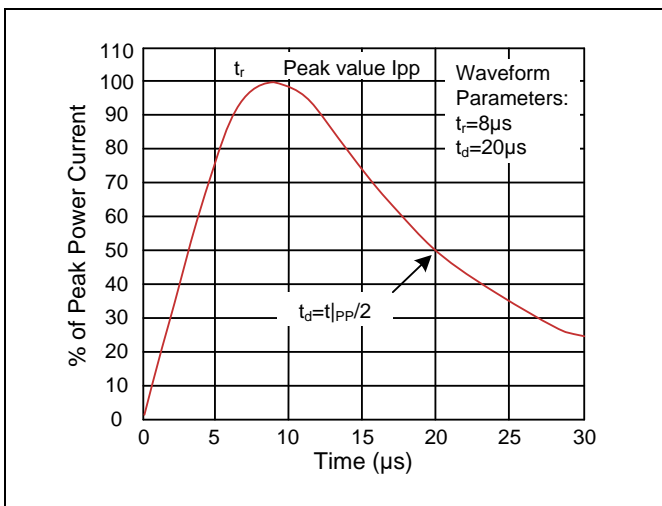

Figure 2. Clamping Voltage vs. Peak Pulse Current

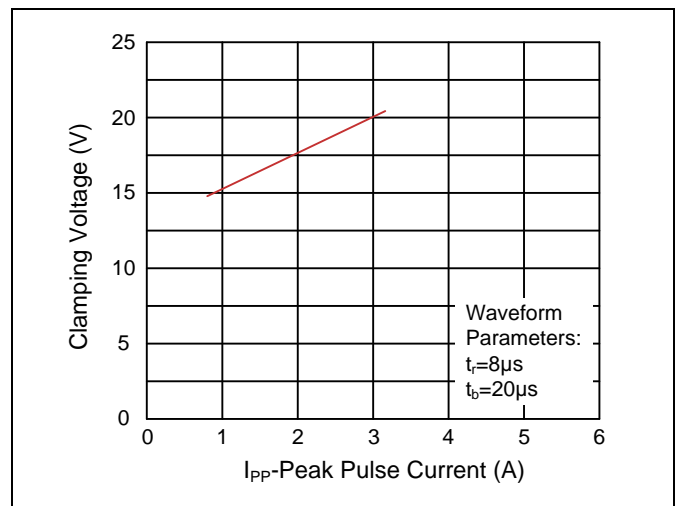

Figure 3. Capacitance vs. Reverse Voltage

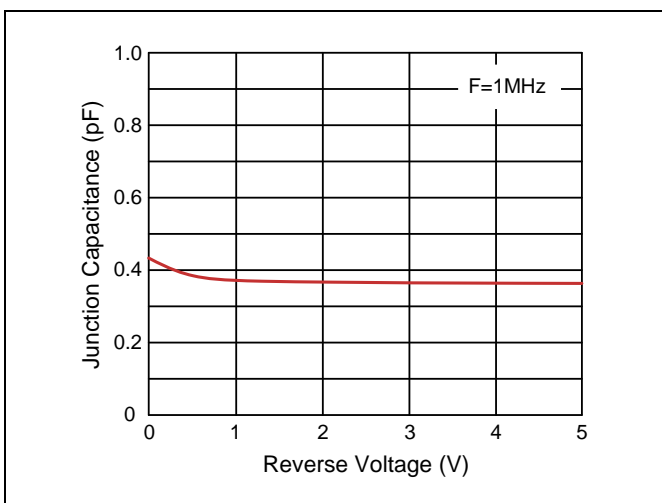
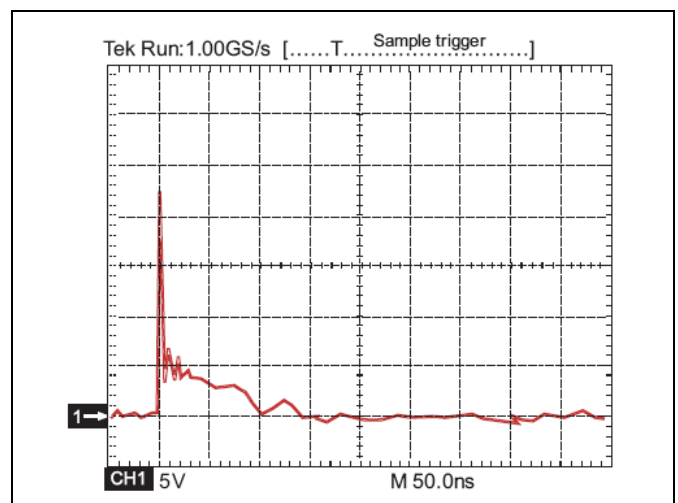
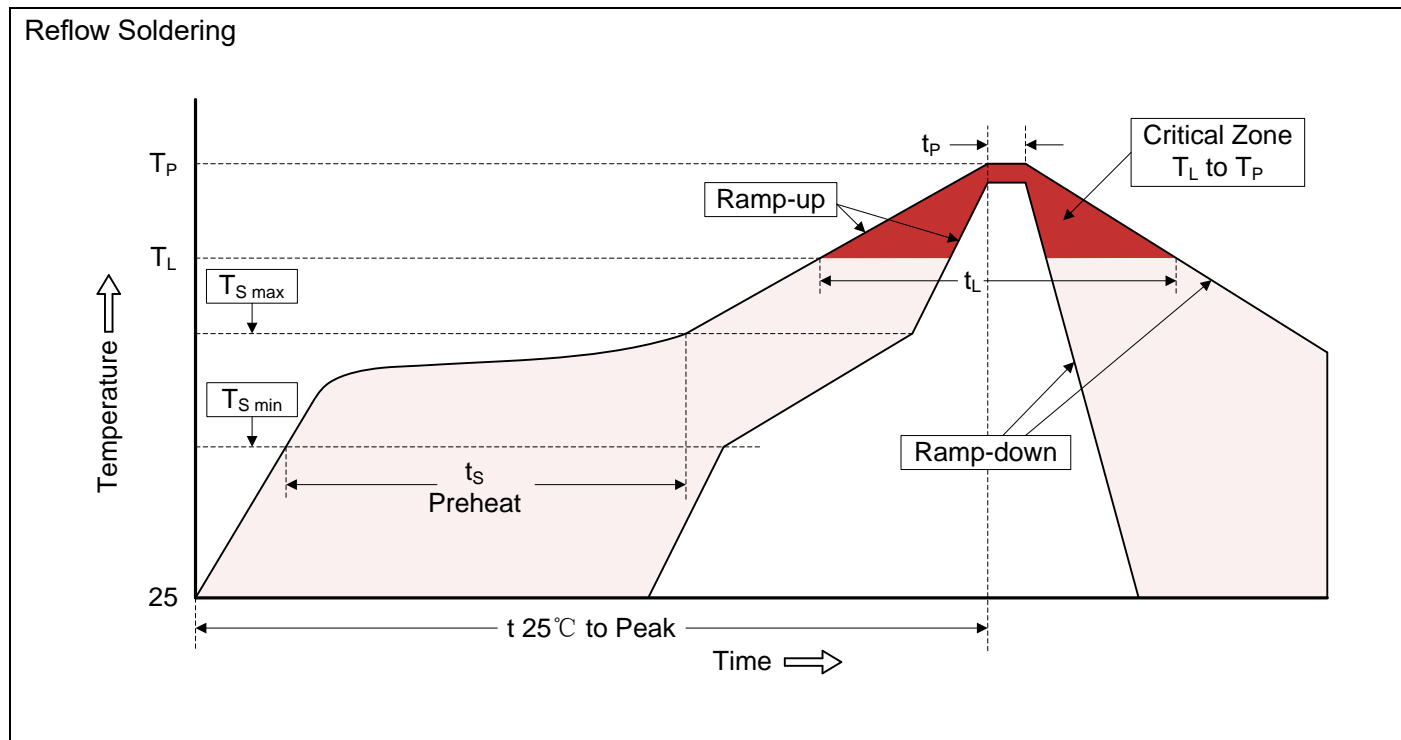

Figure 4. ESD Clamping (8kV Contact IEC61000-4-2)



**Recommended Soldering Conditions**



Recommended Conditions

Profile Feature	Pb-Free Assembly
Average ramp-up rate ( $T_L$ to $T_P$ )	3°C/second max.
Preheat -Temperature Min ( $T_{S\ min}$ ) -Temperature Max ( $T_{S\ max}$ ) -Time (min to max) ( $t_s$ )	150°C 200°C 60-180 seconds
$T_{S\ max}$ to $T_L$ -Ramp-up Rate	3°C/second max.
Time maintained above: -Temperature ( $T_L$ ) -Time ( $t_L$ )	217°C 60-150 seconds
Peak Temperature ( $T_P$ )	260°C
Time within 5°C of actual Peak Temperature ( $t_p$ )	20-40 seconds
Ramp-down Rate	6°C/second max.
Time 25°C to Peak Temperature	8 minutes max.

**Dimensions (DFN0603/QFN-0201)**

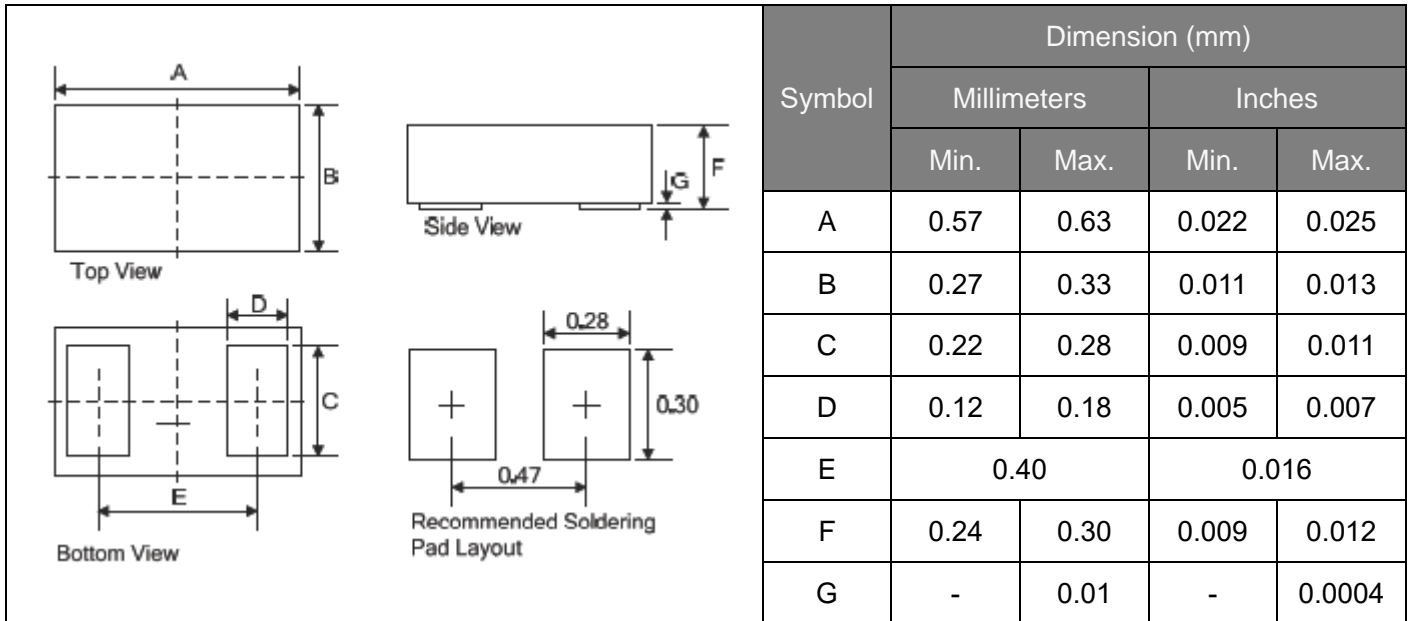

**Packaging**

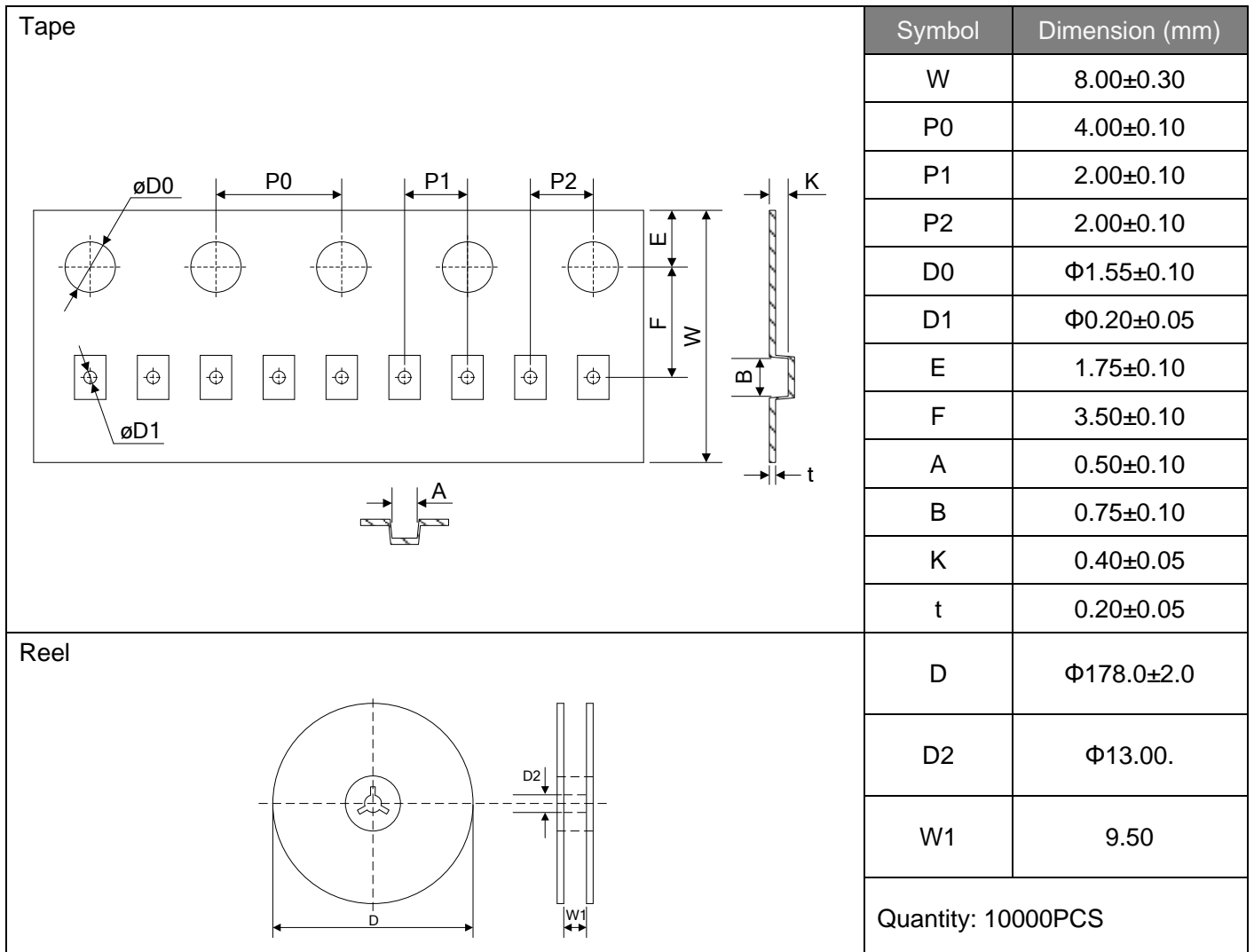

## LEGAL DISCLAIMER

YAGEO, its distributors and agents (collectively, "YAGEO"), hereby disclaims any and all liabilities for any errors, inaccuracies or incompleteness contained in any product related information, including but not limited to product specifications, datasheets, pictures and/or graphics. YAGEO may make changes, modifications and/or improvements to product related information at any time and without notice.



YAGEO makes no representation, warranty, and/or guarantee about the fitness of its products for any particular purpose or the continuing production of any of its products. To the maximum extent permitted by law, YAGEO disclaims (i) any and all liability arising out of the application or use of any YAGEO product, (ii) any and all liability, including without limitation special, consequential or incidental damages, and (iii) any and all implied warranties, including warranties of fitness for a particular purpose, non-infringement and merchantability.

YAGEO products are designed for general purpose applications under normal operation and usage conditions. Please contact YAGEO for the applications listed below which require especially high reliability for the prevention of defects which might directly cause damage to the third party's life, body or property: Aerospace equipment (artificial satellite, rocket, etc.), Atomic energy-related equipment, Aviation equipment, Disaster prevention equipment, crime prevention equipment, Electric heating apparatus, burning equipment, Highly public information network equipment, data-processing equipment, Medical devices, Military equipment, Power generation control equipment, Safety equipment, Traffic signal equipment, Transportation equipment and Undersea equipment, or for any other application or use in which the failure of YAGEO products could result in personal injury or death, or serious property damage. Particularly **YAGEO Corporation and its affiliates do not recommend the use of commercial or automotive grade products for high reliability applications or manned space flight.**





Information provided here is intended to indicate product specifications only. YAGEO reserves all the rights for revising this content without further notification, as long as products are unchanged. Any product change will be announced by PCN.

## Looking for pricing, stock, or lifecycle information?

Click below to explore more details on WIN SOURCE:

-  [View UAQ02C05L01-R0.5 on WIN SOURCE](#)
-  [Yageo Information](#)

## Optimize Your Supply Chain with WIN SOURCE Solutions

-  Global Sourcing Solution
-  Obsolete Management
-  Cost Control Management
-  Shortage Management
-  Alternative Solution
-  Excess Inventory Management