



**THE DATASHEET OF
DF14-6S-1.25C**



DF14 Series

1.25mm Pitch, Low Profile Crimp Connector



Low Profile



Right Angle



Wide Variation

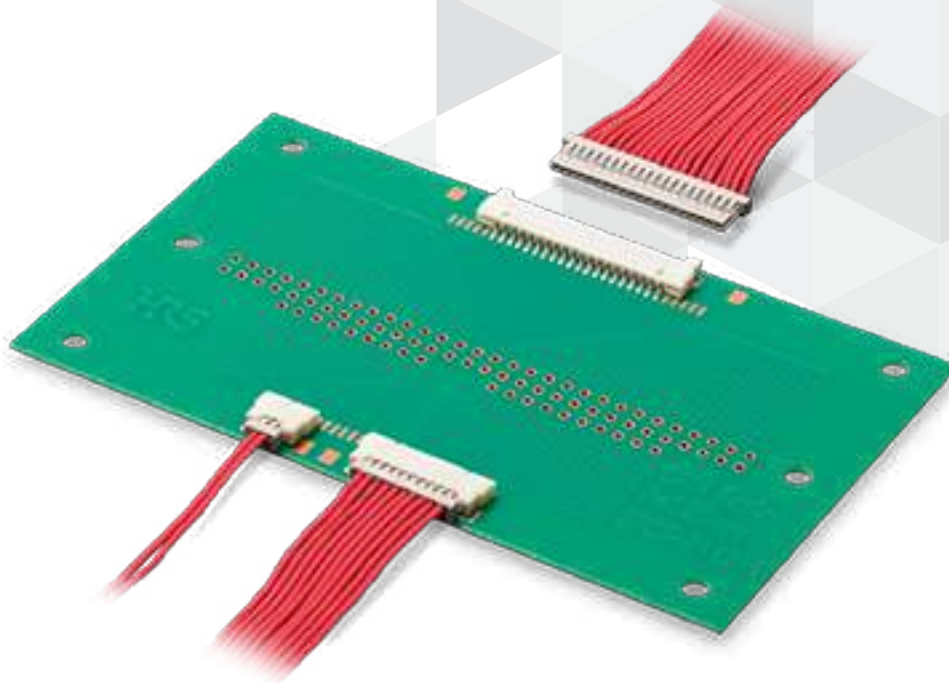

Features

1. Low Profile

DF14 is a right angle connector that enables a low profile on the board. Signals can be routed in places where there is no space between boards using DF14. The on-board type, DF14(A), has a board mounted height of 2.5mm. The offset type, DF14H, has an even lower profile with a board mounted height of 1.6mm.

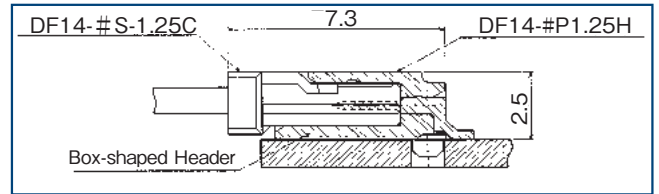

DF14(A) On Board Type Board Mounted Diagram

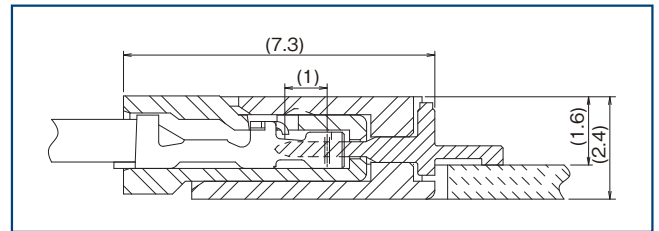

DF14H Offset Type Board Mounted Diagram

2. Pick & Place Mounting

The header has a vacuum suction surface and embossed tape packaging for pick & place mounting. Additionally, tube packaging is available for the on-board type.

3. Four-wall Design

The box-shaped header prevents prying and mis-insertion. The walls on the header prevent issues resulting from friction to the board caused by the socket. Retention tabs are added to prevent solder peeling.

Applications

LCD (crystal panel), Note PCs, PDAs, Small Office Equipment, Video Devices and other Consumer Products.

Product Specifications

Rated Current	1A/pin	Operating Temperature (Note 1)	-35 to +85°C
		Operating Humidity Range (Note 2)	40 to 80%
Rated Voltage	150V AC/DC	Storage Temperature Range (Note 3)	-10 to +60°C
		Storage Humidity Range (Note 3)	40 to 70%

Note 1 : Includes temperature rise due to current flow.

Note 2 : Please use without condensation.

Note 3 : Applicable to unused items in packaged state.

Item	Specification	Condition
Insulation Resistance	500M Ω Min.	100V DC
Withstanding Voltage	No flashover or insulation breakdown.	500V AC per min.
Contact Resistance	30m Ω Max.	Measured at 20mV or less, 1mA (DC or 1000Hz)
Insertion/ Extraction Force	0.15N Min. (15gf), 3N Max. (300gfl)	Measured with 0.3 ^{+0.005} ₀ mm square pin
Vibration Resistance	No electrical discontinuity of 1 μ s or more	Frequency : 10 to 55Hz, single amplitude of 0.75mm, 2 hours in each of the 3 directions.
Humidity (Steady State)	Contact resistance : 30m Ω Max. Insulation resistance : 500M Ω Min.	96 hours at temperature of 40 \pm 2°C and humidity of 90% to 95%
Temperature Cycle	Contact resistance : 30m Ω Max. Insulation resistance : 500M Ω Min.	(-55°C : 30 minutes \rightarrow 5 to 35°C : 2-3 minutes \rightarrow 85°C : 30 minutes \rightarrow 5 to 35°C : 2-3 minutes) 5 cycles
Mating Durability	Contact resistance : 30m Ω Max.	Tin Plating : 30 cycles Gold Plating : 50 cycles
Soldering Heat Resistance	No deformation of components affecting performance.	SMT Type Reflow : At the recommended temperature profile Manual soldering : 350°C for 3 seconds

Material / Finish

Product	Part	Material	Finish	Remarks	RoHS2
Crimp Socket	Insulator	Polyamide	Beige	UL94V-0	○
Socket Crimp Contact	Contact	Phosphor Copper	Tin or Gold Plated	-	
Pin Header	Insulator	Polyamide	Beige	UL94V-0	
	Contact	Brass	Tin or Gold Plated	-	
	Retention Tab	Phosphor Copper	Tin Plated	-	

Product Number Structure

Refer to the chart below when determining the product specifications from the product number.
Please select from the product numbers listed in this catalog when placing orders.

Connector

DF14 # - # S - 1.25 C

① ② ③ ④ ⑤ ⑥

① Series Name	DF14	④ Connector Type	S : Single Row Socket P : Single Row Pin Header
② Configuration	Blank : Standard On-board, with Boss A : On-board, without Boss H : Offset	⑤ Contact Pitch	1.25mm
③ No. of Pos.	2 to 10, 15, 20, 25, 30	⑥ Contact Type	C : Crimping Socket H : Right Angle SMT

Contact

DF14 - 2628 SCF A

① ② ③

① Applicable Cable Size	2628 : 26 to 28 AWG 3032 : 30 to 32 AWG	② Packaging Type	SCF : Socket contact/reel
		③ Plating Type	Blank : Tin Plated A : Gold Plated

Crimp Socket



Shown with crimp contacts assembled.

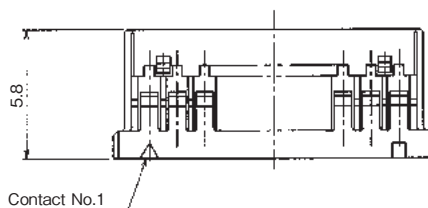
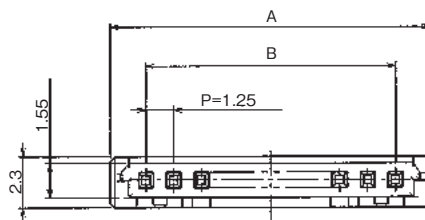

Unit : mm

Part No.	HRS No.	No. of Pos.	A	B	Purchase Unit
DF14-2S-1.25C(10)	CL0538-0005-8-10	2	4.45	1.25	100pcs per bag
DF14-3S-1.25C(10)	CL0538-0006-0-10	3	5.70	2.50	
DF14-4S-1.25C(10)	CL0538-0007-3-10	4	6.95	3.75	
DF14-5S-1.25C(10)	CL0538-0008-6-10	5	8.20	5.00	
DF14-6S-1.25C(10)	CL0538-0009-9-10	6	9.45	6.25	
DF14-7S-1.25C(10)	CL0538-0010-8-10	7	10.70	7.50	
DF14-8S-1.25C(10)	CL0538-0011-0-10	8	11.95	8.75	
DF14-9S-1.25C(10)	CL0538-0013-6-10	9	13.20	10.00	
DF14-10S-1.25C(10)	CL0538-0014-9-10	10	14.45	11.25	
DF14-15S-1.25C(10)	CL0538-0054-3-10	15	20.70	17.50	
DF14-20S-1.25C(10)	CL0538-0059-7-10	20	26.95	23.75	
DF14-25S-1.25C(10)	CL0538-0064-7-10	25	33.20	30.00	
DF14-30S-1.25C(10)	CL0538-0012-3-10	30	39.45	36.25	

Socket Crimp Contact

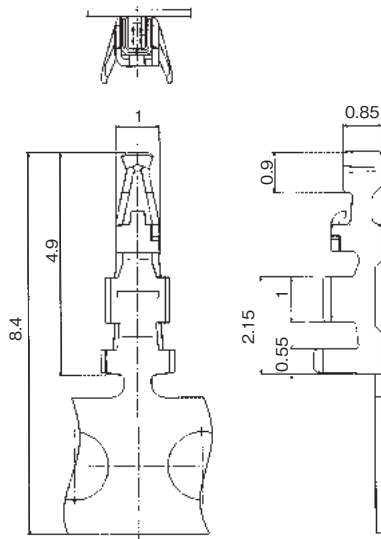

● Applicable Cable (Tin Plating Annealed Copper Wire)

Strip Length : 1.2 to 1.9mm (Note 3)

Part No.	HRS No.	Finish	Purchase Unit	Applicable Cable (Tin Plated Annealed Conductor) (Note 1)				
				UL	AWG	Wire Construction	Sectional area	Jacket diameter (Note 2)
DF14-2628SCF	CL0538-0001-7-00	Tin Plated	10,000pcs per reel	1571	26 AWG	7/0.16mm	0.141mm ²	0.54 to 1mm(0.98mm)
					28 AWG	7/0.127mm	0.089mm ²	0.54 to 1mm(0.88mm)
DF14-2628SCFA	CL0538-0002-0-00	Gold Plated		1571	26 AWG	7/0.16mm	0.141mm ²	0.54 to 1mm(0.98mm)
					28 AWG	7/0.127mm	0.089mm ²	0.54 to 1mm(0.88mm)
DF14-3032SCF	CL0538-0003-2-00	Tin Plated		1571	30 AWG	7/0.1mm	0.055mm ²	0.54 to 1mm(0.7mm)
					32 AWG	7/0.08mm	0.035mm ²	0.54 to 1mm(0.54mm)
DF14-3032SCFA	CL0538-0004-5-00	Gold Plated		1571	30 AWG	7/0.1mm	0.055mm ²	0.54 to 1mm(0.7mm)
					32 AWG	7/0.08mm	0.035mm ²	0.54 to 1mm(0.54mm)

Note 1 : Please contact a Hirose sales representative when using cables other than those specified.

Note 2 : When crimping with a manual crimping tool, only the wires with the outer diameter of the coating shown in parentheses are applicable.

Note 3 : The strip length is a reference value. Adjust each dimension after crimping so that it satisfies the standard value.

Right Angle Pin Header (On-board SMT)

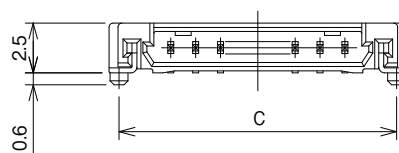
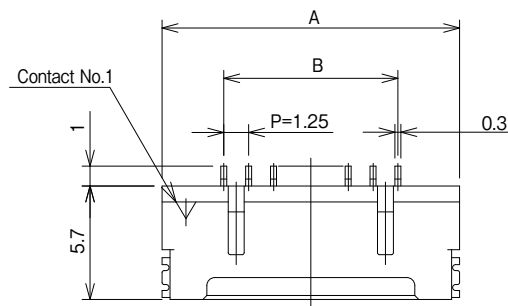

Note 1 : Guide Post

Note 1 : "Without boss" indicates the style with no boss.

PCB Mounting Pattern

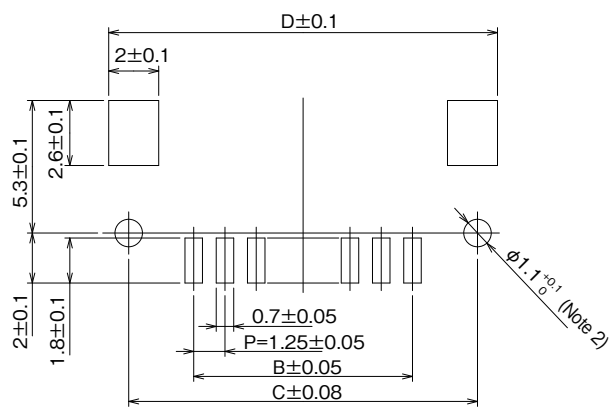

Note 2 : "Without boss" indicates that no hole is needed.

Unit : mm

With Boss		Without Boss		No. of Pos.	A	B	C	D	Purchase Unit
Part No.	HRS No.	Part No.	HRS No.						
DF14-2P-1.25H(##)	CL0538-0021-4-##	DF14A-2P-1.25H(##)	CL0538-0033-3-##	2	7.45	1.25	6.45	8.05	66pcs per tube
DF14-3P-1.25H(##)	CL0538-0022-7-##	DF14A-3P-1.25H(##)	CL0538-0034-6-##	3	8.70	2.50	7.70	9.30	56pcs per tube
DF14-4P-1.25H(##)	CL0538-0023-0-##	DF14A-4P-1.25H(##)	CL0538-0035-9-##	4	9.95	3.75	8.95	10.55	49pcs per tube
DF14-5P-1.25H(##)	CL0538-0024-2-##	DF14A-5P-1.25H(##)	CL0538-0036-1-##	5	11.20	5.00	10.20	11.80	44pcs per tube
DF14-6P-1.25H(##)	CL0538-0025-5-##	DF14A-6P-1.25H(##)	CL0538-0037-4-##	6	12.45	6.25	11.45	13.05	39pcs per tube
DF14-7P-1.25H(##)	CL0538-0026-8-##	DF14A-7P-1.25H(##)	CL0538-0038-7-##	7	13.70	7.50	12.70	14.30	36pcs per tube
DF14-8P-1.25H(##)	CL0538-0027-0-##	DF14A-8P-1.25H(##)	CL0538-0039-0-##	8	14.95	8.75	13.95	15.55	32pcs per tube
DF14-9P-1.25H(##)	CL0538-0028-3-##	DF14A-9P-1.25H(##)	CL0538-0040-9-##	9	16.20	10.00	15.20	16.80	30pcs per tube
DF14-10P-1.25H(##)	CL0538-0029-6-##	DF14A-10P-1.25H(##)	CL0538-0041-1-##	10	17.45	11.25	16.45	18.05	28pcs per tube
DF14-15P-1.25H(##)	CL0538-0084-4-##	DF14A-15P-1.25H(##)	CL0538-0114-3-##	15	23.70	17.50	22.70	24.30	20pcs per tube
DF14-20P-1.25H(##)	CL0538-0089-8-##	DF14A-20P-1.25H(##)	CL0538-0119-7-##	20	29.95	23.75	28.95	30.55	16pcs per tube
DF14-25P-1.25H(##)	CL0538-0094-8-##	DF14A-25P-1.25H(##)	CL0538-0124-7-##	25	36.20	30.00	35.20	36.80	13pcs per tube
DF14-30P-1.25H(##)	CL0538-0020-1-##	DF14A-30P-1.25H(##)	CL0538-0045-2-##	30	42.45	36.25	41.45	43.05	11pcs per tube

[Specifications] -##, (##)

(22) : Tin Plated, Embossed Tape Packaging

(35) : Tin Plated, Tube Packaging

(52) : Gold Plated, Embossed Tape Packaging

(65) : Gold Plated, Tube Packaging

Note 1 : Please order the tube packaging product, multiplying the packaging quantity (pcs.).

Note 2 : Please order the embossed tape packaging product according to reel number. (1000pcs./reel)

Tube Packaging Dimensions

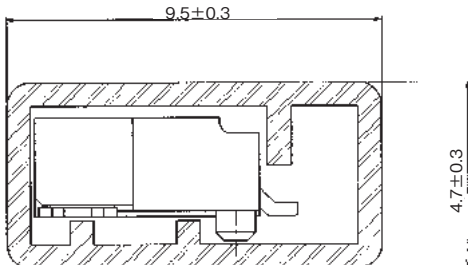

Right Angle Pin Header (Offset SMT)

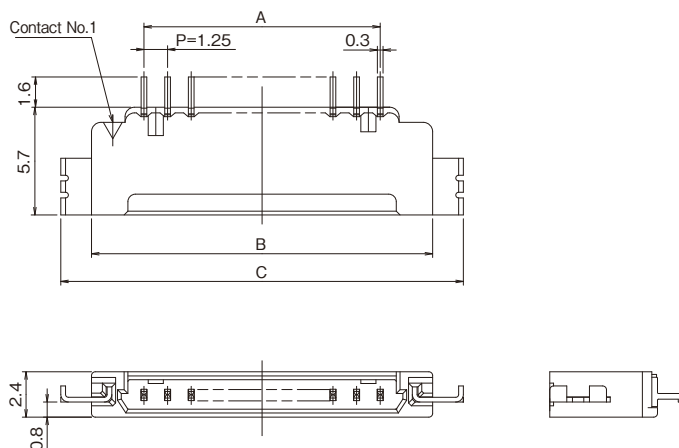

PCB Mounting Pattern

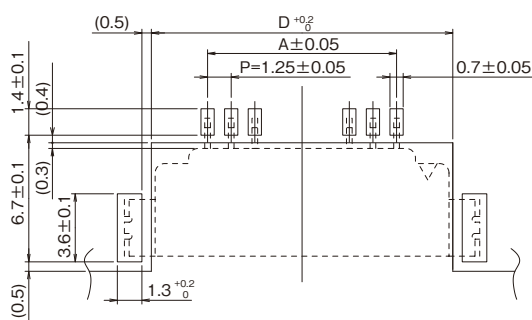

Unit : mm

Part No.	HRS No.	No. of Pos.	A	B	C	D	Purchase Unit
DF14H-20P-1.25H(##)	CL0538-0167-0-##	20	23.75	29.3	32.6	29.7	1000pcs per reel
DF14H-30P-1.25H(##)	CL0538-0188-0-##	30	36.25	41.8	45.1	42.2	

[Specific No.] -##, (##)

(52) : Gold Plated, Embossed Tape Packaging

Embossed Carrier Tape Dimensions (JIS-C-0806)

■ 2 to 10 pos.

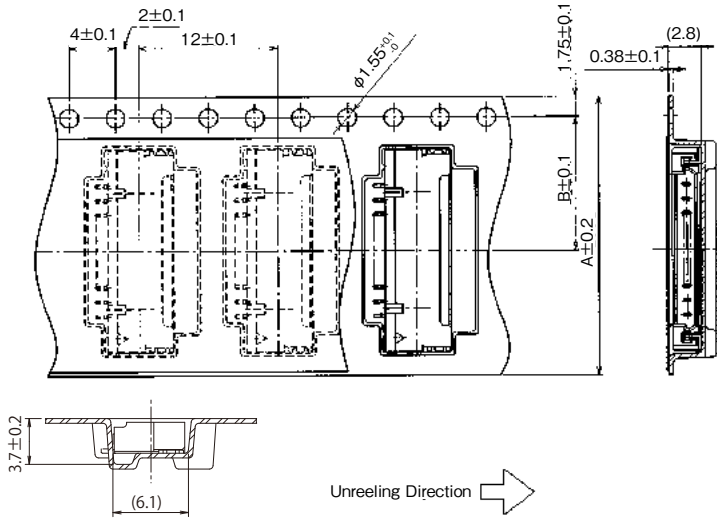

■ 15, 20, 25, 30 pos.

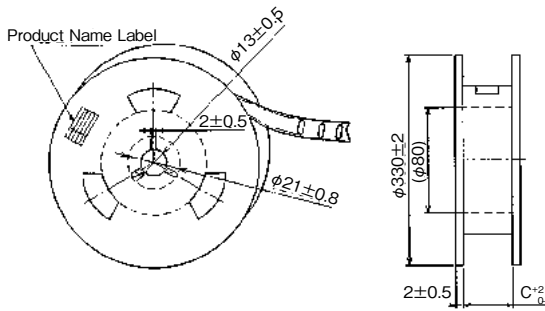
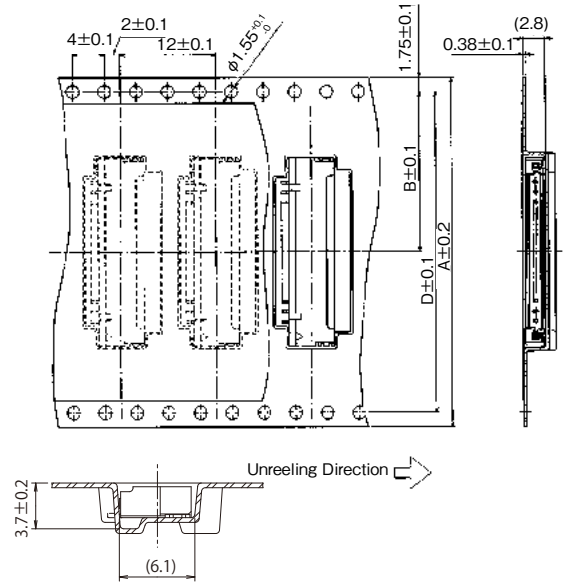

Unit : mm

Part No.	No. of Pos.	A	B	C	D
DF14/14A- 2P-1.25H	2	16.0	7.5	16.4	-
DF14/14A- 3P-1.25H	3				
DF14/14A- 4P-1.25H	4	24.0	11.5	24.4	-
DF14/14A- 5P-1.25H	5				
DF14/14A- 6P-1.25H	6				
DF14/14A- 7P-1.25H	7				
DF14/14A- 8P-1.25H	8				
DF14/14A- 9P-1.25H	9				
DF14/14A-10P-1.25H	10	44.0	20.2	44.4	40.4
DF14/14A-15P-1.25H	15				
DF14/14A-20P-1.25H	20				
DF14/14A-25P-1.25H	25	56.0	26.2	56.4	52.4
DF14/14A-30P-1.25H	30				

Embossed Carrier Tape Dimensions (JIS-C-0806)

DF14H-#P-1.25H

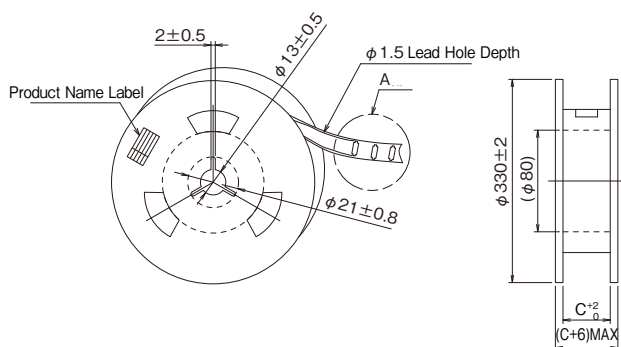
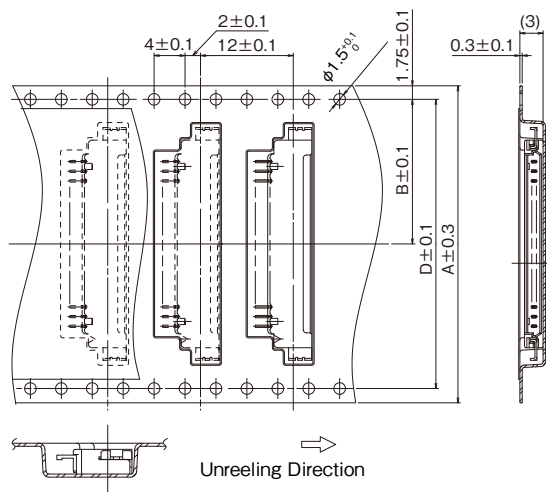

Unit : mm

Part No.	No. of Pos.	A	B	C	D
DF14H-20P-1.25H	20	44.0	20.2	44.4	40.4
DF14H-30P-1.25H	30	56.0	26.2	56.4	52.4

Applicable Crimping Tool

Type	Part No.	HRS No.	Applicable Contact
Applicator	AP105-DF14-2628S	CL0901-4548-1-00	DF14-2628SCF/DF14-2628SCFA
	AP105-DF14-3032S	CL0901-4544-0-00	DF14-3032SCF/DF14-3032SCFA
Manual Crimping Tool	DF14-2628/CR-HT	CL0901-0001-0-00	DF14-2628SCF/DF14-2628SCFA
	DF14-3032/CR-HT	CL0550-0261-1-00	DF14-3032SCF/DF14-3032SCFA
Press Unit	CM-105C	CL0901-0001-0-00	-
Extraction tool	DF-C-PO(B)	CL0550-0179-2-00	DF14-2628SCF/DF14-2628SCFA
			DF14-3032SCF/DF14-3032SCFA

Note 1 : Please perform crimping work based on the crimping quality standard (ETAD-H0819-00) and crimping condition table.

Note 2 : The warranty does not cover problems caused by tools other than those specified by us.

Note 3 : For manual crimping tools, the reel terminals are cut continuously.

Crimping Precautions

■ Items Required Prior to Crimping

The work- related documents shown below are required before starting harness assembly.

(The ● mark represents required documents.)

Please contact your Hirose sales representative if you do not have these documents.

Document Title	Description	Automatic Crimping	Hand Crimping	Remarks
Crimping Machine Main Unit Instruction Manual	Explanation of main press unit	●	—	Bundled with purchase of main press machine unit.
Applicator Instruction Manual	Crimp Method	●	—	Bundled with purchase of applicator.
Applicator Spare Parts List	Applicator Installation Instruction	●	—	
Crimp Conditions	Crimp height, tensile strength standard value	●	—	
Crimp Quality Standards	Various standards for crimping conditions	●	—	
Hand Tool Operating Instructions	Crimp method, crimp height and tensile height standard value	—	●	Bundled with purchase of hand tool.
Cable Assembly	Cable assembly	●	●	Contact a Hirose sales representative.

■ Tools

- Use tools designated by Hirose when crimping.
- Crimping performed using tools other than those specified is outside the scope of warranty.
- The operating instructions are available for the crimping machine and the applicator. Be sure to carefully read the operating instructions manual before beginning work.

■ Applicable Cables

Check that the cables to be used are within the applicable range.

If you intend to use a cable other than those recommended, contact a sales representative.

[Precautions]

- Cables applicable to crimping connectors are tin- plated stranded soft- copper wire.
- Avoid crimping solid wire, wires with polyester threads or tin coated wires.
- Avoid crimping two cables together.
- The crimp height setting values (Note 1) may vary between tin- plated and gold- plated terminals even if the same electric wires are used.
- The crimp height setting values (Note 1) may vary depending on the difference in the core wire configuration even if the computed cross- sectional area is the same.

Note 1 : The crimp height is an important item that determines crimping quality. We execute crimping tests for each electric wire to ensure the optimal value for the crimp height with high precision, thereby ensuring optimal setup values.

Precautions

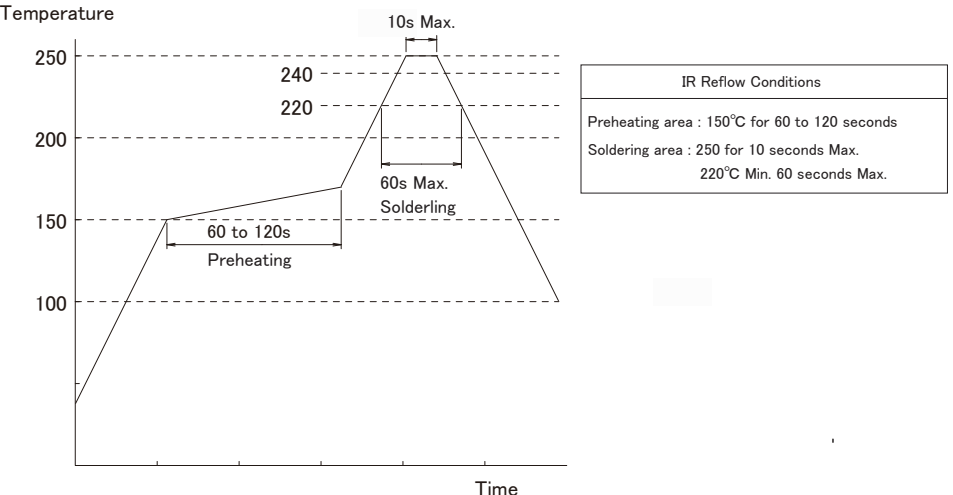
<p>1. Recommended Temperature Profile (SMT)</p>	 <p>Note 1 : Up to 2 cycles of reflow soldering are possible under the same conditions, provided that there is a return to normal temperature between the first and second cycle.</p> <p>Note 2 : The temperature profile indicates the temperature of the surface of the connector lead.</p>
<p>2. Recommended Manual Soldering Conditions (SMT)</p>	<p>Manual soldering : 350°C for 3 seconds</p>
<p>3. Recommended Screen Thickness (SMT)</p>	<p>0.15 to 0.2mm</p>
<p>4. Board Warpage (SMT)</p>	<p>Max 0.03mm at the connector in reference in the both edges of the connector.</p>
<p>5. Cleaning Conditions</p>	<p>Refer to "Wire-to-Board Connector Use Handbook."</p>
<p>6. Termination Conditions</p>	<p>Refer to "Wire-to-Board Connector Use Handbook."</p> <ul style="list-style-type: none"> ■ Crimp contacts are small, so please make sure to perform crimping based on the instructions in the "Crimping Conditions" and "Crimping Quality Standards".
<p>7. Cautions</p>	<ul style="list-style-type: none"> ■ Excessive prying during mating and unmating may result in damage. For details, refer to the "Instruction Manual". ■ Black spots may appear on the mold resin but this does not affect the product quality.
<p>8. Handling</p>	<p>Please refer to the following documents when handling the product.</p> <ul style="list-style-type: none"> ■ Crimp Quality Standard (ETAD-H0819-00) ■ Wire-to-Board Connector Use Handbook

■ Precautions During Insertion

● Handling

Method : Lightly grasping the base of the cable, press the connector with your finger and insert it.

● Insertion Angle

[Caution] Do not insert at an angle of 30° or greater. Doing so will cause contact deformation or case damage.

Method : Insert with the connector parallel to the board.

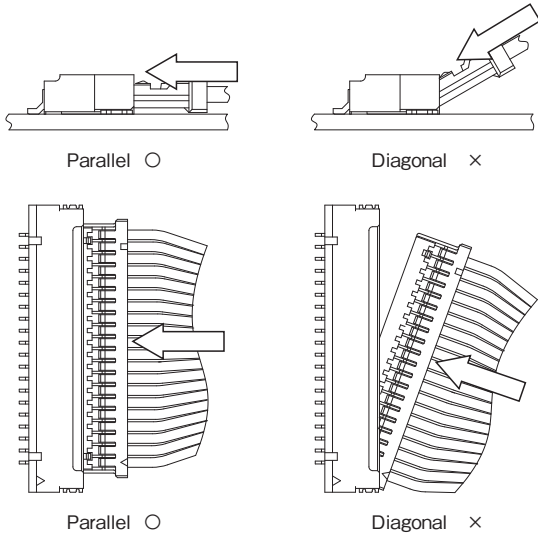

■ Precautions During Disconnection

● Handling

Method : Grasp the cable so that it held evenly and pull out.

● Removal Angle

[Caution] Do not remove at an angle of 30° or greater. Doing so will cause contact deformation or case damage.

Method : Remove with the connector parallel to the board.

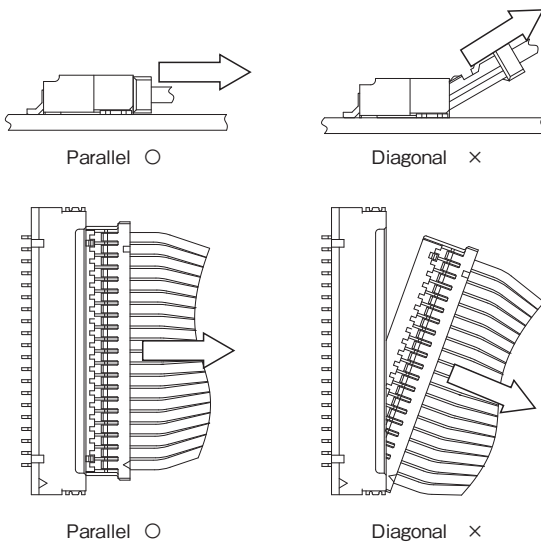

While Taking into Consideration

Specifications mentioned in this catalog are reference values.

When considering to order or use this product, please review the Drawing and Product Specifications sheets.

Use an appropriate cable when using the connector in combination with cables.

If considering usage of a non-specified cable, please contact your sales representative.

If assembly process is done by jigs & tools which are not identified by Hirose, the warranty of the product may be affected.

If considering usage for below mentioned applications, please contact your sales representative.

In cases where the application will demand a high level of reliability, such as automotive, medical instruments, public infrastructure, aerospace/defense etc. Hirose must review before assurance of reliability can be given.

HIROSE**HIROSE ELECTRIC CO.,LTD.**2-6-3 Nakagawa Chuoh, Tsuzuki-Ku, Yokohama-Shi 224-8540, JAPAN
<https://www.hirose.com>

Looking for pricing, stock, or lifecycle information?

Click below to explore more details on WIN SOURCE:

- [View DF14-6S-1.25C on WIN SOURCE](#)
- [Hirose Electric Co Ltd Information](#)

Optimize Your Supply Chain with WIN SOURCE Solutions

- ✓ Global Sourcing Solution
- ✓ Obsolete Management
- ✓ Cost Control Management
- ✓ Shortage Management
- ✓ Alternative Solution
- ✓ Excess Inventory Management