



# THE DATASHEET OF SMAJ20CA/TR13



# DATA SHEET

## TRANSIENT VOLTAGE SUPPRESSORS

### AC/DC POWER SUPPLY

SMAJ series

RoHS compliant & Halogen free

Product specification— June 30, 2023 V.4



## Transient Voltage Suppressors (TVS) Data Sheet

### Features

- For surface mounted applications in order to optimize board space
- Low profile package
- Glass passivated junction
- Low inductance
- Excellent clamping capability
- 400W peak pulse power capability at 10/1000 $\mu$ s waveform, repetition rate (duty cycle): 0.01%
- Fast response time
- Typical  $I_R$  less than 1 $\mu$ A above 10V
- High Temperature soldering: 260 $^{\circ}$ C/10 seconds at terminals
- Plastic package has underwriters laboratory flammability 94V-0
- Meets MSL level 1, per J-STD-020
- Safety certification: UL
- IEC61000-4-2 ESD 30KV Air, 30KV contact compliance



### Mechanical Data

- Case: JEDEC DO-214AC. Molded plastic over glass passivated junction
- Terminal: Tin plated, solderable per MIL-STD-750, Method 2026
- Polarity: Color band denotes cathode except bi-directional models
- Standard Packaging: 12mm tape (EIA STD RS-481)
- Weight: 0.07g

### Applications

- I/O interface
- AC/DC power supply
- Low frequency signal transmission line (RS232, RS485, etc.)

### Maximum Ratings and Characteristics

Ratings at 25 $^{\circ}$ C ambient temperature unless otherwise specified.

Rating	Symbol	Value	Units
Peak pulse power dissipation at 10/1000 $\mu$ s waveform (Note1, Note2, Fig.1)	$P_{PPM}$	Minimum 400	Watts
Peak pulse current of at 10/1000 $\mu$ s waveform (Note 1, Fig.3)	$I_{PPM}$	See Table	Amps
Steady state power dissipation at $T_A=50^{\circ}$ C (Fig.5)	$P_{M(AV)}$	3.3	Watts
Peak forward surge current, 8.3ms single half sine-wave superimposed on rated load, (JEDEC Method) (Note3, Fig.6)	$I_{FSM}$	40	Amps
Operating junction and Storage Temperature Range.	$T_J, T_{STG}$	-55 to +150	$^{\circ}$ C
Typical thermal resistance junction to lead	$R_{\theta JL}$	30	$^{\circ}$ C/W
Typical thermal resistance junction to ambient	$R_{\theta JA}$	120	$^{\circ}$ C/W

Notes: 1. Non-repetitive current pulse, per Fig.3 and derated above  $T_A=25^{\circ}$ C per Fig.2.

2. Mounted on 5.0mm $\times$ 5.0mm (0.03mm thick) copper pads to each terminal.

3. 8.3ms single half sine-wave, or equivalent square wave, duty cycle=4 pulses per minutes maximum.

**Dimensions (SMA/DO-214AC)**

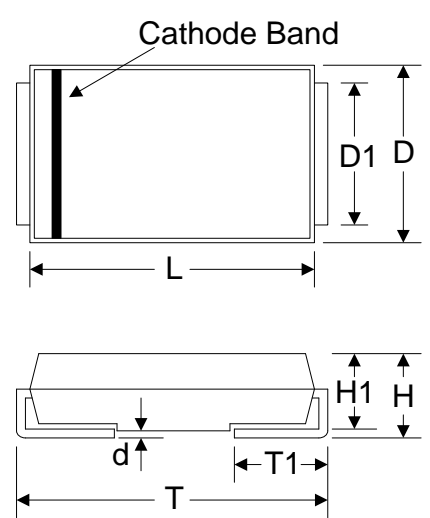
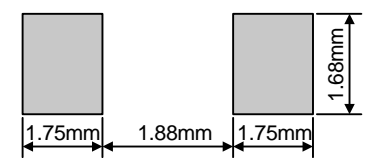
<p>Product:</p>  <p>Pad:</p> 	Symbol	Millimeters		Inches	
		Min.	Max.	Min.	Max.
	L	3.99	4.50	0.157	0.177
	D	2.54	2.79	0.100	0.110
	D1	1.25	1.65	0.049	0.065
	T	4.93	5.28	0.194	0.208
	T1	0.76	1.52	0.030	0.060
	d	-	0.203	-	0.008
	H	2.00	2.50	0.079	0.098
	H1	1.98	2.29	0.078	0.090

**Electrical Characteristics (T<sub>A</sub>=25°C)**

Part Number		Device Marking Code		Reverse Stand-Off Voltage	Breakdown Voltage @I <sub>T</sub>	Test Current	Maximum Clamping Voltage @I <sub>PP</sub>	Peak Pulse Current	Reverse Leakage @V <sub>RWM</sub>
Unidirectional	Bidirectional	UNI	BI	V <sub>RWM</sub> (V)	V <sub>BR</sub> (V)	I <sub>T</sub> (mA)	V <sub>C</sub> (V)	I <sub>PP</sub> (A)	I <sub>R</sub> (µA)
SMAJ5.0A	SMAJ5.0CA	AE	WE	5.0	6.40~7.00	10	9.2	43.5	800
SMAJ6.0A	SMAJ6.0CA	AG	WG	6.0	6.67~7.37	10	10.3	38.8	800
SMAJ6.5A	SMAJ6.5CA	AK	WK	6.5	7.22~7.98	10	11.2	35.7	500
SMAJ7.0A	SMAJ7.0CA	AM	WM	7.0	7.78~8.60	10	12.0	33.3	200
SMAJ7.5A	SMAJ7.5CA	AP	WP	7.5	8.33~9.21	1	12.9	31.0	100
SMAJ8.0A	SMAJ8.0CA	AR	WR	8.0	8.89~9.83	1	13.6	29.4	50
SMAJ8.5A	SMAJ8.5CA	AT	WT	8.5	9.44~10.40	1	14.4	27.8	20
SMAJ9.0A	SMAJ9.0CA	AV	WV	9.0	10.00~11.10	1	15.4	26.0	10
SMAJ10A	SMAJ10CA	AX	WX	10.0	11.10~12.30	1	17.0	23.5	5
SMAJ11A	SMAJ11CA	AZ	WZ	11.0	12.20~13.50	1	18.2	22.0	1
SMAJ12A	SMAJ12CA	BE	XE	12.0	13.30~14.70	1	19.9	20.1	1
SMAJ13A	SMAJ13CA	BG	XG	13.0	14.40~15.90	1	21.5	18.6	1
SMAJ14A	SMAJ14CA	BK	XK	14.0	15.60~17.20	1	23.2	17.2	1
SMAJ15A	SMAJ15CA	BM	XM	15.0	16.70~18.50	1	24.4	16.4	1
SMAJ16A	SMAJ16CA	BP	XP	16.0	17.80~19.70	1	26.0	15.4	1
SMAJ17A	SMAJ17CA	BR	XR	17.0	18.90~20.90	1	27.6	14.5	1
SMAJ18A	SMAJ18CA	BT	XT	18.0	20.00~22.10	1	29.2	13.7	1

**Transient Voltage Suppressors** SMAJ

Part Number		Device Marking Code		Reverse Stand-Off Voltage	Breakdown Voltage @ $I_T$	Test Current	Maximum Clamping Voltage @ $I_{PP}$	Peak Pulse Current	Reverse Leakage @ $V_{RWM}$
Unidirectional	Bidirectional	UNI	BI	$V_{RWM}(V)$	$V_{BR}(V)$	$I_T(mA)$	$V_C(V)$	$I_{PP}(A)$	$I_R(\mu A)$
SMAJ20A	SMAJ20CA	BV	XV	20.0	22.20~24.50	1	32.4	12.3	1
SMAJ22A	SMAJ22CA	BX	XX	22.0	24.40~26.90	1	35.5	11.3	1
SMAJ24A	SMAJ24CA	BZ	XZ	24.0	26.70~29.50	1	38.9	10.3	1
SMAJ26A	SMAJ26CA	CE	YE	26.0	28.90~31.90	1	42.1	9.5	1
SMAJ28A	SMAJ28CA	CG	YG	28.0	31.10~34.40	1	45.4	8.8	1
SMAJ30A	SMAJ30CA	CK	YK	30.0	33.30~36.80	1	48.4	8.3	1
SMAJ33A	SMAJ33CA	CM	YM	33.0	36.70~40.60	1	53.3	7.5	1
SMAJ36A	SMAJ36CA	CP	YP	36.0	40.00~44.20	1	58.1	6.9	1
SMAJ40A	SMAJ40CA	CR	YR	40.0	44.40~49.10	1	64.5	6.2	1
SMAJ43A	SMAJ43CA	CT	YT	43.0	47.80~52.80	1	69.4	5.8	1
SMAJ45A	SMAJ45CA	CV	YV	45.0	50.00~55.30	1	72.7	5.5	1
SMAJ48A	SMAJ48CA	CX	YX	48.0	53.30~58.90	1	77.4	5.2	1
SMAJ51A	SMAJ51CA	CZ	YZ	51.0	56.70~62.70	1	82.4	4.9	1
SMAJ54A	SMAJ54CA	RE	ZE	54.0	60.00~66.30	1	87.1	4.6	1
SMAJ58A	SMAJ58CA	RG	ZG	58.0	64.40~71.20	1	93.6	4.3	1
SMAJ60A	SMAJ60CA	RK	ZK	60.0	66.70~73.70	1	96.8	4.1	1
SMAJ64A	SMAJ64CA	RM	ZM	64.0	71.10~78.60	1	103.0	3.9	1
SMAJ70A	SMAJ70CA	RP	ZP	70.0	77.80~86.00	1	113.0	3.5	1
SMAJ75A	SMAJ75CA	RR	ZR	75.0	83.30~92.10	1	121.0	3.3	1
SMAJ78A	SMAJ78CA	RT	ZT	78.0	86.70~95.80	1	126.0	3.2	1
SMAJ85A	SMAJ85CA	RV	ZV	85.0	94.40~104.00	1	137.0	2.9	1
SMAJ90A	SMAJ90CA	RX	ZX	90.0	100.00~111.00	1	146.0	2.7	1
SMAJ100A	SMAJ100CA	RZ	ZZ	100.0	111.00~123.00	1	162.0	2.5	1
SMAJ110A	SMAJ110CA	SE	VE	110.0	122.00~135.00	1	177.0	2.3	1
SMAJ120A	SMAJ120CA	SG	VG	120.0	133.00~147.00	1	193.0	2.1	1
SMAJ130A	SMAJ130CA	SK	VK	130.0	144.00~159.00	1	209.0	1.9	1
SMAJ150A	SMAJ150CA	SM	VM	150.0	167.00~185.00	1	243.0	1.6	1
SMAJ160A	SMAJ160CA	SP	VP	160.0	178.00~197.00	1	259.0	1.5	1
SMAJ170A	SMAJ170CA	SR	VR	170.0	189.00~209.00	1	275.0	1.5	1
SMAJ180A	SMAJ180CA	ST	VT	180.0	201.00~222.00	1	292.0	1.4	1
SMAJ190A	SMAJ190CA	SU	YU	190.0	211.00~233.00	1	308.0	1.3	1
SMAJ200A	SMAJ200CA	SV	VV	200.0	224.00~247.00	1	324.0	1.2	1
SMAJ210A	SMAJ210CA	SW	YW	210.0	237.00~263.00	1	340.0	1.2	1
SMAJ220A	SMAJ220CA	GE	VX	220.0	246.00~272.00	1	356.0	1.1	1
SMAJ250A	SMAJ250CA	SZ	VZ	250.0	279.00~309.00	1	405.0	1.0	1
SMAJ300A	SMAJ300CA	TE	UE	300.0	335.00~371.00	1	486.0	0.8	1
SMAJ350A	SMAJ350CA	TG	UG	350.0	391.00~432.00	1	567.0	0.7	1
SMAJ400A	SMAJ400CA	TK	UK	400.0	447.00~494.00	1	648.0	0.6	1
SMAJ440A	SMAJ440CA	TM	UM	440.0	492.00~543.00	1	713.0	0.6	1

**Ratings and Characteristic Curves ( $T_A=25^\circ\text{C}$  unless otherwise noted)**

Figure 1. Peak Pulse Power Rating Curve

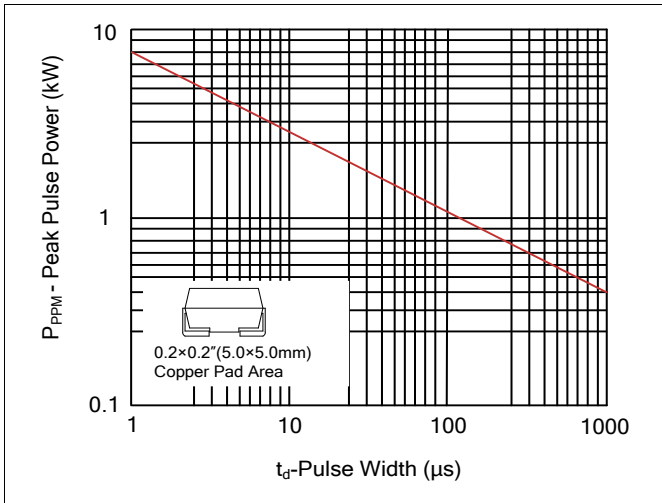

Figure 2. Pulse Derating Curve

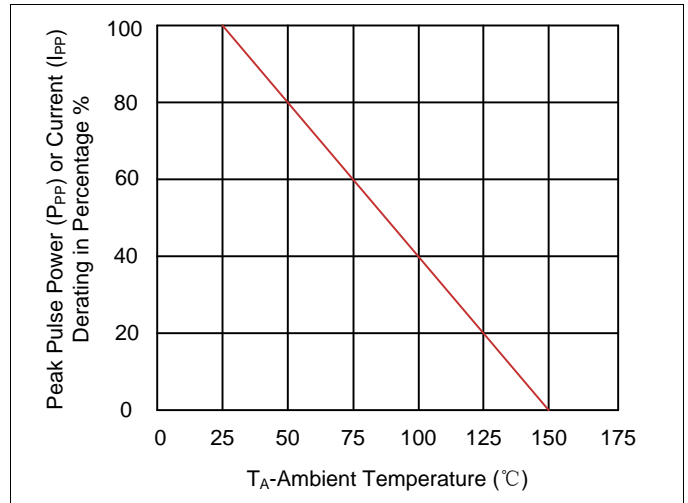

Figure 3. Pulse Waveform

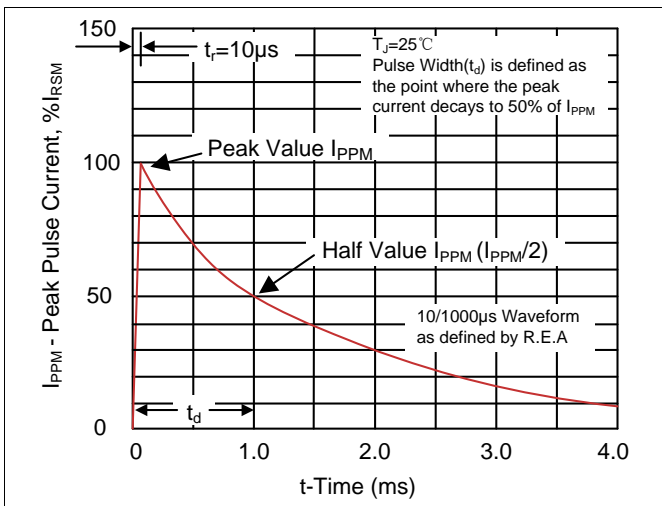

Figure 4. Typical Junction Capacitance

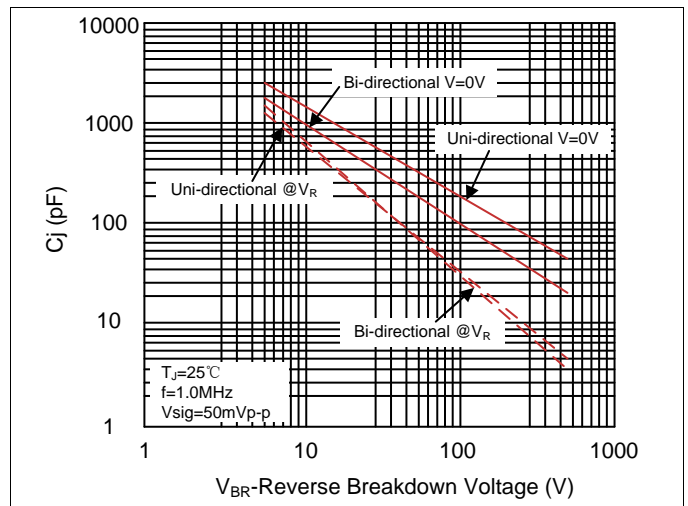

Figure 5. Steady State Power Dissipation Derating Curve

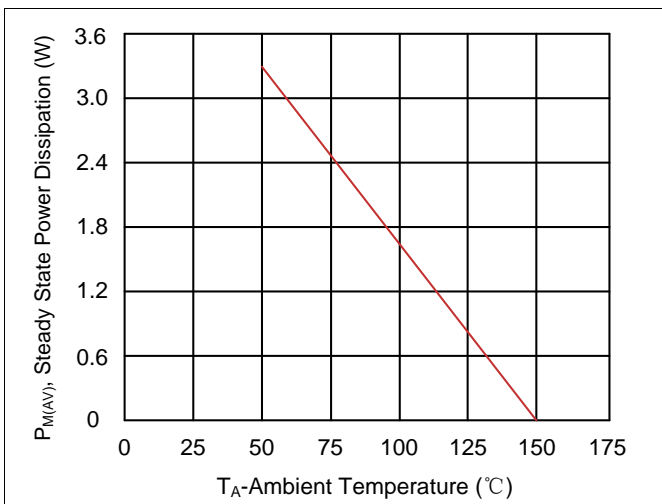

Figure 6. Maximum Non-Repetitive Forward Surge Current Uni-Directional Only



**Recommended Soldering Conditions**

Reflow Soldering



Recommended Conditions

Profile Feature	Pb-Free Assembly
Average ramp-up rate ( $T_L$ to $T_P$ )	3°C/second max.
Preheat	
-Temperature Min ( $T_{S\ min}$ )	150°C
-Temperature Max ( $T_{S\ max}$ )	200°C
-Time (min to max) ( $t_s$ )	60-180 seconds
$T_{S\ max}$ to $T_L$	
-Ramp-up Rate	3°C/second max.
Time maintained above:	
-Temperature ( $T_L$ )	217°C
-Time ( $t_L$ )	60-150 seconds
Peak Temperature ( $T_P$ )	260°C
Time within 5°C of actual Peak Temperature ( $t_P$ )	20-40 seconds
Ramp-down Rate	6°C/second max.
Time 25°C to Peak Temperature	8 minutes max.

**Marking Code**



**Part Number Code**



**Ordering Code for Different Package**

7 inch reel package: Add suffix “ /TR7 ” at the end of the part number, such as SMAJXXXCA/TR7

13 inch reel package: Add suffix “ /TR13 ” at the end of the part number, such as SMAJXXXCA/TR13

**Packaging**

Tape	Symbol	Dimension (mm)	
	W	12.00±0.20	
	P0	4.00±0.10	
	P1	4.00±0.10	
	P2	2.00±0.10	
	D0	Φ1.5±0.10	
	D1	Φ1.5±0.10	
	E	1.75±0.10	
	F	5.50±0.05	
	A0	2.79±0.10	
	B0	5.33±0.10	
	K0	2.55±0.15	
	T	0.25±0.05	
	7" Reel	D2	Φ178.0±2.0
		D3	Φ50.0Min.
D4		Φ13.0±0.5	
W1		16.0±2.0	
Quantity: 1000PCS			
13" Reel	D5	Φ330.0±2.0	
	D6	Φ13.5±0.5	
	H	2.5±1.0	
	W2	16.0±2.0	
	Quantity: 5000PCS		

## LEGAL DISCLAIMER

YAGEO, its distributors and agents (collectively, "YAGEO"), hereby disclaims any and all liabilities for any errors, inaccuracies or incompleteness contained in any product related information, including but not limited to product specifications, datasheets, pictures and/or graphics. YAGEO may make changes, modifications and/or improvements to product related information at any time and without notice.

YAGEO makes no representation, warranty, and/or guarantee about the fitness of its products for any particular purpose or the continuing production of any of its products. To the maximum extent permitted by law, YAGEO disclaims (i) any and all liability arising out of the application or use of any YAGEO product, (ii) any and all liability, including without limitation special, consequential or incidental damages, and (iii) any and all implied warranties, including warranties of fitness for a particular purpose, non-infringement and merchantability.

YAGEO products are designed for general purpose applications under normal operation and usage conditions. Please contact YAGEO for the applications listed below which require especially high reliability for the prevention of defects which might directly cause damage to the third party's life, body or property: Aerospace equipment (artificial satellite, rocket, etc.), Atomic energy-related equipment, Aviation equipment, Disaster prevention equipment, crime prevention equipment, Electric heating apparatus, burning equipment, Highly public information network equipment, data-processing equipment, Medical devices, Military equipment, Power generation control equipment, Safety equipment, Traffic signal equipment, Transportation equipment and Undersea equipment, or for any other application or use in which the failure of YAGEO products could result in personal injury or death, or serious property damage. Particularly **YAGEO Corporation and its affiliates do not recommend the use of commercial or automotive grade products for high reliability applications or manned space flight.**

Information provided here is intended to indicate product specifications only. YAGEO reserves all the rights for revising this content without further notification, as long as products are unchanged. Any product change will be announced by PCN.

## Looking for pricing, stock, or lifecycle information?

Click below to explore more details on WIN SOURCE:

- ⊖ [View SMAJ20CA/TR13](#) on WIN SOURCE
- ⊖ [Yageo](#) Information

## Optimize Your Supply Chain with WIN SOURCE Solutions

- ✓ Global Sourcing Solution
- ✓ Obsolete Management
- ✓ Cost Control Management
- ✓ Shortage Management
- ✓ Alternative Solution
- ✓ Excess Inventory Management