



**THE DATASHEET OF
LAS2W331MELC35**



ALUMINUM ELECTROLYTIC CAPACITORS

LAS

Snap-in Terminal Type, 105°C Permissible Abnormal Voltage, Smaller-sized



Smaller

- Withstanding 2000 hours application of rated ripple current of 105°C.
- Smaller case sizes and higher ripple current than LAQ.
- Improved safety features for abnormally excessive voltage.
- Ideally suited for the equipment used at voltage fluctuating area.
- Compliant to the RoHS directive (2011/65/EU,(EU)2015/863).

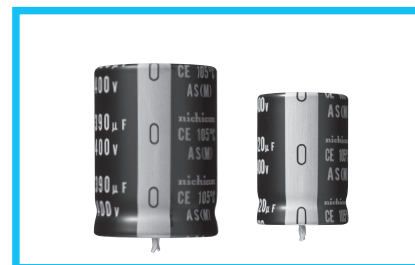

Specifications

Item	Performance Characteristics				
Category Temperature Range	-25 to +105°C				
Rated Voltage Range	400 · 420 · 450V				
Rated Capacitance Range	56 to 390μF				
Capacitance Tolerance	±20% at 120Hz, 20°C				
Leakage Current	$I \leq 3\sqrt{CV}$ (μA) (After 5 minutes' application of rated voltage at 20°C) [C : Rated Capacitance (μF) V : Voltage (V)]				
Tangent of loss angle (tan δ)	0.20max. 120Hz at 20°C				
Stability at Low Temperature	Rated voltage (V)	400 · 420 · 450		Measurement frequency : 120Hz	
	Impedance ratio (max.)	$Z(-25^{\circ}\text{C}) / Z(+20^{\circ}\text{C})$	8		
Endurance	The specifications listed at right shall be met when the capacitors are restored to 20°C after D.C. bias plus rated ripple current is applied for 2000 hours at 105°C, the peak voltage shall not exceed the rated voltage.			Capacitance change	Within ±20% of the initial capacitance value
				tan δ	200% or less than the initial specified value
				Leakage current	Less than or equal to the initial specified value
Shelf Life	After storing the capacitors under no load at 105°C for 1000 hours and then performing voltage treatment based on JIS C 5101-4 clause 4.1 at 20°C, they shall meet the requirements listed at right.			Capacitance change	Within ±15% of the initial capacitance value
				tan δ	150% or less than the initial specified value
				Leakage current	Less than or equal to the initial specified value
Safety Performance	The pressure relief vent will operate in normal conditions, with no dangerous conditions such as flames, ignitions or dispersion of pieces of the capacitor and / or case.				
	Rating		Test conditions		
	Voltage (V)	Rated Capacitance (μF)	Limited DC current	Test voltage	
	400	C < 100	2 A	500VDC and 600VDC	
		100 ≤ C < 220	4 A		
		220 ≤ C	7 A		
	420	C < 100	2 A	520VDC and 630VDC	
100 ≤ C < 220		4 A			
220 ≤ C		7 A			
450	C < 100	2 A	550VDC and 675VDC		
	100 ≤ C < 220	4 A			
	220 ≤ C	7 A			
Marking	Printed with white color letter on black sleeve				

Drawing

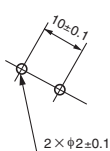
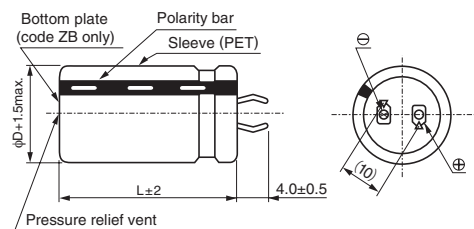

(PC board hole dimensions)

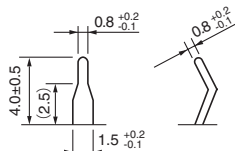

(Terminal dimensions)

Type numbering system (Example : 400V 100μF)

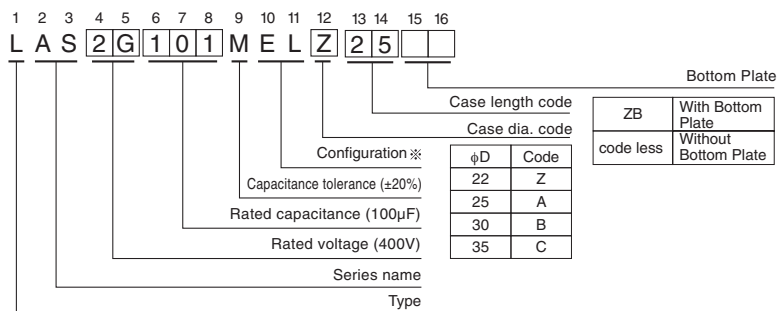

※ Please contact to us if other configurations are required.

Frequency coefficient of rated ripple current

Frequency (Hz)	50	60	120	1 k	10k or more	
Coeff.	400 · 420 · 450V	0.88	0.9	1.00	1.10	1.15

● Dimension table in next page.

LAS

■ Dimensions

400V(2G)				
Cap. (μF)	Size φD × L(mm)	Ripple (mArms)	Leakage Current (mA)	Code
56	22 × 20	450	0.44	LAS2G560MELZ20
68	22 × 20	510	0.49	LAS2G680MELZ20
82	22 × 25	640	0.54	LAS2G820MELZ25
100	22 × 25	680	0.60	LAS2G101MELZ25
120	22 × 30	760	0.65	LAS2G121MELZ30
	25 × 25	760	0.65	LAS2G121MELA25
150	22 × 35	880	0.73	LAS2G151MELZ35
	25 × 30	880	0.73	LAS2G151MELA30
	30 × 25	880	0.73	LAS2G151MELB25
180	22 × 40	950	0.80	LAS2G181MELZ40
	25 × 30	950	0.80	LAS2G181MELA30
	30 × 25	950	0.80	LAS2G181MELB25
220	25 × 35	1240	0.88	LAS2G221MELA35
	30 × 30	1240	0.88	LAS2G221MELB30
270	25 × 40	1300	0.98	LAS2G271MELA40
	30 × 35	1300	0.98	LAS2G271MELB35
330	30 × 35	1440	1.08	LAS2G331MELB35
390	30 × 40	1550	1.18	LAS2G391MELB40



420V(W6)				
Cap. (μF)	Size φD × L(mm)	Ripple (mArms)	Leakage Current (mA)	Code
56	22 × 25	380	0.46	LASW6560MELZ25
68	22 × 25	450	0.50	LASW6680MELZ25
82	22 × 30	640	0.55	LASW6820MELZ30
	25 × 25	640	0.55	LASW6820MELA25
100	22 × 30	690	0.61	LASW6101MELZ30
	25 × 25	690	0.61	LASW6101MELA25
120	22 × 35	750	0.67	LASW6121MELZ35
	25 × 30	750	0.67	LASW6121MELA30
	30 × 25	750	0.67	LASW6121MELB25
150	22 × 40	820	0.75	LASW6151MELZ40
	25 × 35	820	0.75	LASW6151MELA35
	30 × 25	820	0.75	LASW6151MELB25
180	25 × 40	900	0.82	LASW6181MELA40
	30 × 30	900	0.82	LASW6181MELB30
	35 × 25	900	0.82	LASW6181MELC25
220	25 × 45	1000	0.91	LASW6221MELA45
	30 × 35	1000	0.91	LASW6221MELB35
	35 × 30	1000	0.91	LASW6221MELC30
270	30 × 40	1100	1.01	LASW6271MELB40
	35 × 30	1100	1.01	LASW6271MELC30
330	30 × 45	1200	1.11	LASW6331MELB45
	35 × 35	1200	1.11	LASW6331MELC35
390	35 × 45	1300	1.21	LASW6391MELC45

450V (2W)				
Cap. (μF)	Size φD × L(mm)	Ripple (mArms)	Leakage Current (mA)	Code
68	22 × 25	600	0.52	LAS2W680MELZ25
82	22 × 30	650	0.57	LAS2W820MELZ30
	25 × 25	610	0.57	LAS2W820MELA25
100	22 × 30	710	0.63	LAS2W101MELZ30
	25 × 25	710	0.63	LAS2W101MELA25
120	22 × 35	770	0.69	LAS2W121MELZ35
	25 × 30	760	0.69	LAS2W121MELA30
	30 × 25	770	0.69	LAS2W121MELB25
150	25 × 35	880	0.77	LAS2W151MELA35
	30 × 25	880	0.77	LAS2W151MELB25
180	30 × 30	970	0.85	LAS2W181MELB30
220	30 × 35	1300	0.94	LAS2W221MELB35
270	35 × 30	1300	1.04	LAS2W271MELC30
330	35 × 35	1400	1.15	LAS2W331MELC35







Rated ripple current (mArms) at 105°C 120Hz

Looking for pricing, stock, or lifecycle information?

Click below to explore more details on WIN SOURCE:

-  [View LAS2W331MELC35 on WIN SOURCE](#)
-  [Nichicon Information](#)

Optimize Your Supply Chain with WIN SOURCE Solutions

-  Global Sourcing Solution
-  Obsolete Management
-  Cost Control Management
-  Shortage Management
-  Alternative Solution
-  Excess Inventory Management