



**THE DATASHEET OF
A759PY337M1JAAE042**





Overview

KEMET's Radial Solid Polymer Aluminum Capacitors offer longer life and greater stability across a wide range of temperatures. This highly conductive solid polymer electrolyte eliminates the risk of drying out and, due to its low ESR properties, is able to withstand higher ripple currents during normal operation. This series is ideally suited for industrial and commercial applications.

Applications

Typical applications include long life LED drivers, professional power amplifiers, industrial power supplies, DC/DC converters, voltage regulators, and decoupling.

Benefits

- Through-hole form factor
- High voltage
- Low impedance
- High ripple current
- 125°C/2,000 hours
- RoHS compliant
- Halogen-free

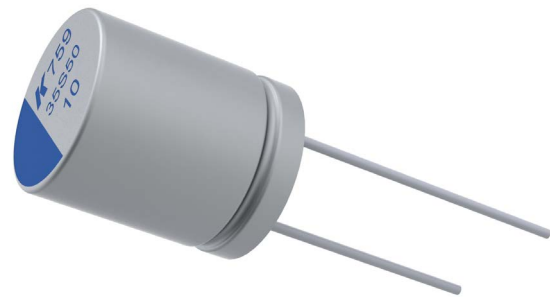

Part Number System

A	759	BQ	106	M	1V	AA	E	090
Capacitor Class	Series	Size Code	Capacitance Code (pF)	Tolerance	Rated Voltage (VDC)	Packaging	Electrical Parameters	ESR
A = Aluminum	Radial Solid Polymer Aluminum Capacitors 125°C 2,000 hours	See Dimension Table	First two digits represent significant figures for capacitance values. Last digit specifies the number of zeros to be added.	M = ±20%	6.3 = 0J 10 = 1A 16 = 1C 20 = 1D 25 = 1E 35 = 1V 50 = 1H 63 = 1J 80 = 1K 100 = 2A 160 = 2C 250 = 2E	See Ordering Options Table	E = Standard/ESR	Last 3 digits represent significant figures for ESR values. (mΩ)

Ordering Options Table

Diameter	Packaging Type	Lead Type	Lead Length (mm)	Lead and Packaging Code
Standard Bulk Packaging Options				
5 - 22	Bulk (bag)	Long Lead (Loose Standard Leads)	15 Minimum	AA
5 - 18	Bulk (bag)	Cut Leads	5 ⁽¹⁾	BA
5 - 18	Bulk (bag)	Formed Leads	5 ⁽¹⁾	CA
Standard Auto-Insertion Packaging Options				
5	Ammo Tape and Box	Formed to 2.5 mm	H ₀ = 16±0.5	FA
5 - 8	Ammo Tape and Box	Formed to 5 mm	H ₀ = 16±0.5	DA
6 - 8	Ammo Tape and Box	Straight	H = 18.5±0.5 (for 8 x 12 H = 20±0.5)	EA
10 - 13	Ammo Tape and Box	Straight	H = 18.5±0.5	EA
Contact KEMET for other Lead and Packaging options ⁽¹⁾ Contact KEMET for custom Lead Length and options 3 to 10 mm				

Size Code	Dimensions DxL	Lead and Packaging Code (SPQ)			
		AA Bulk (Bag)	BA Bulk (Bag)	CA Bulk (Bag)	DA, EA, FA Ammo, Tape and Box
BG	5x7	1,000	1,000	1,000	2,000
BK	5x8	1,000	1,000	1,000	2,000
BM	5x9	1,000	1,000	1,000	2,000
BQ	5x11	1,000	1,000	1,000	2,000
EA	6.3x5	1,000	1,000	1,000	1,500
EK	6.3x8	1,000	1,000	1,000	1,500
EM	6.3x9	1,000	1,000	1,000	1,500
EQ	6.3x11	1,000	1,000	1,000	1,500
KK	8x8	500	500	500	1,000
KR	8x11.5	500	500	500	1,000
KS	8x12	500	500	500	1,000
KV	8x14	500	500	500	1,000
KW	8x16	500	500	500	1,000
MS	10x12	250	250	250	600
MU	10x12.5	250	250	250	600
MV	10x14	250	250	250	600
MW	10x16	250	250	250	600

Long Lead (Loose Standard Leads)

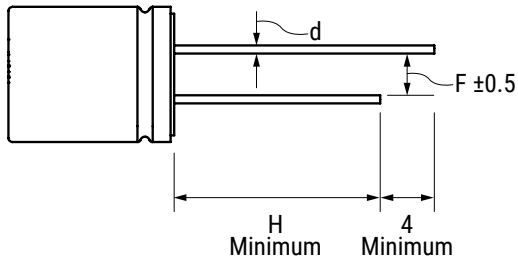

	Diameter					
	5	6.3	8	10	13	18
d	0.5	0.5	0.6	0.6	0.6	0.8
F	2	2.5	3.5	5	5	7.5
H	15	15	15	15	15	15

Cut Lead

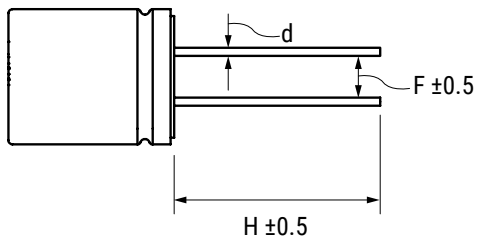

	Diameter					
	5	6.3	8	10	13	18
d	0.5	0.5	0.6	0.6	0.6	0.8
F	2	2.5	3.5	5	5	7.5
H	According to customer requirement 3 - 10 mm					

Formed Lead

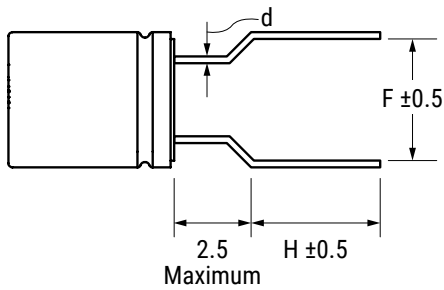

	Diameter					
	5	6.3	8	10	13	18
d	0.5	0.5	0.6	0.6	0.6	0.8
F	5	5	5	5	5	5
H	According to customer requirement 3 - 10 mm					

Dimensions – Millimeters

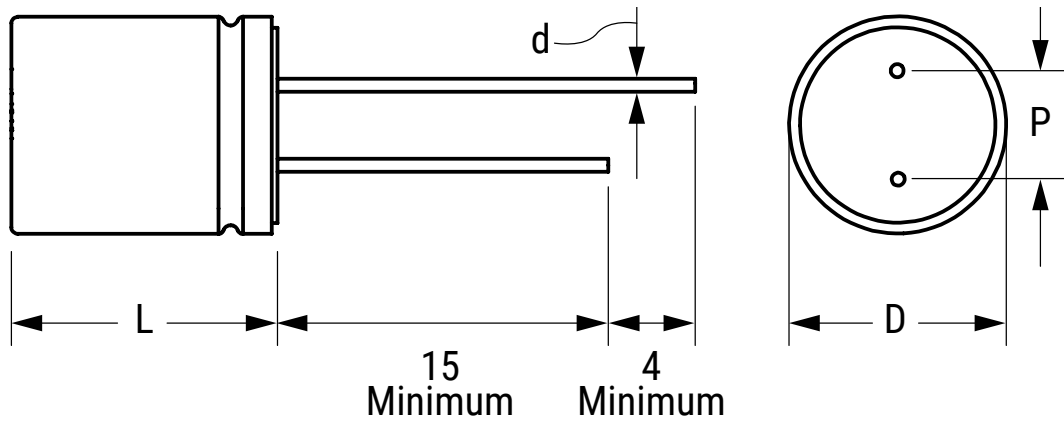

Size Code	D		L		d		P		Sleeve	Safety Vent
	Nominal	Tolerance	Nominal	Tolerance	Nominal	Tolerance	Nominal	Tolerance		
BQ	5	±0.5	11	±1.0	0.5	±0.05	2	±0.5		
EA	6.3	±0.5	5	±1.0	0.45	±0.05	2.5	±0.5		
EK	6.3	±0.5	8	±1.0	0.5	±0.05	2.5	±0.5		
EQ	6.3	±0.5	11	±1.0	0.5	±0.05	2.5	±0.5		
KC	8	±0.5	6	±1.0	0.45	±0.05	3.5	±0.5		
KK	8	±0.5	8	±1.0	0.6	±0.05	3.5	±0.5		
KR	8	±0.5	11.5	±1.5	0.6	±0.05	3.5	±0.5		
KS	8	±0.5	12	±1.0	0.6	±0.05	3.5	±0.5		
MS	10	±0.5	12	±1.0	0.6	±0.05	5	±0.5		Yes
MU	10	±0.5	12.5	±1.5	0.6	±0.05	5	±0.5		Yes
MW	10	±0.5	16	±2.0	0.6	±0.05	5	±0.5		Yes
MX	10	±0.5	18	±2.0	0.6	±0.05	5	±0.5	PET	Yes
MY	10	±0.5	20	±2.0	0.6	±0.05	5	±0.5	PET	Yes
PY	13	±0.5	20	±2.0	0.6	±0.05	5	±0.5	PET	Yes
SZ	18	±0.5	31	±2.0	0.8	±0.05	7.5	±0.5	PET	Yes
TC	22	±0.5	45	±2.0	0.8	±0.05	10	±0.5	PET	Yes

Performance Characteristics

Item	Performance Characteristics
Capacitance Range	2.2 – 2,200 μ F
Rated Voltage	6.3 – 250 VDC
Operating Temperature	-55°C to +125°C
Capacitance Tolerance	\pm 20% at 120 Hz/20°C
Life Test	2,000 hours (see conditions in Test Method & Performance)
Leakage Current	$I \leq 0.15 CV$ or 120 μ A, whichever is greater
	C = Rated capacitance (μ F), V = Rated voltage (VDC), Voltage applied for 2 minutes at 20°C.

Dissipation Factor (tan δ)

Rated Voltage (V)	35 – 250
tan δ (maximum) at 120 Hz/20°C	0.12

Compensation Factor of Ripple Current (RC) vs. Frequency

Frequency	120 Hz \leq f < 1 kHz	1 kHz \leq f < 10 kHz	10 kHz \leq f < 100 kHz	100 kHz \leq f < 500 kHz
Coefficient	0.05	0.30	0.70	1.00

Test Method & Performance

Conditions	Load Life Test	Shelf Life Test
Temperature	125°C	125°C
Test Duration	2,000 hours	96 hours
Ripple Current	No ripple current applied	No ripple current applied
Voltage	The sum of DC voltage and the peak AC voltage must not exceed the rated voltage of the capacitor	No voltage applied
Performance	The following specifications will be satisfied when the capacitor is restored to 20°C.	
Capacitance Change	Within ±20% of the initial value	
Dissipation Factor	Does not exceed 150% of the specified value	
ESR	Does not exceed 150% of the specified value	
Leakage Current	Does not exceed specified value	
Damp Heat	The following specifications will be satisfied when the capacitor is restored to 20°C after application of rated voltage for 1,000 hours at 60°C, 90%~95% RH.	
Capacitance Change	Within ±20% of the initial value	
Dissipation Factor	Does not exceed 150% of the specified value	
ESR	Does not exceed 150% of the specified value	
Leakage Current	Does not exceed specified value	
Surge Voltage (Rated Voltage x 1.15 (V))	The following specifications will be satisfied when the capacitor is subjected to 1,000 cycles, each consisting of charge with the surge voltages specified at 105°C for 30 seconds through a protective resistor (Rc = 1 kΩ) and discharge for 5 minutes, 30 seconds.	
Capacitance Change	Within ±20% of the initial value	
Dissipation Factor	Does not exceed 150% of the specified value	
ESR	Does not exceed 150% of the specified value	
Leakage Current	Does not exceed specified value	

Shelf Life & Re-Ageing

Shelf Life

Solderability is 12 months

The capacitance, ESR and impedance of a capacitor will not change significantly after extended storage periods, however the leakage current will slowly increase.

- This series should not be stored in high temperatures or where there is a high level of humidity.
- The suitable storage condition is +5 to +35°C and less than 75% in relative humidity.
- Do not store in damp conditions such as water, saltwater spray or oil spray.
- Do not store in an environment full of hazardous gas (hydrogen sulphide, sulphurous acid gas, nitrous acid, chlorine gas, ammonium, etc.)
- Do not store under exposure to ozone, ultraviolet rays or radiation.

If a capacitor has been stored for more than 24 months under these conditions and it shows increased leakage current, then a treatment by voltage application is recommended.

Re-age Procedure

Apply the rated DC voltage to the capacitor at 125°C for a period of 120 minutes through a 1 kΩ series resistor.

Environmental Compliance



All Part Numbers in this datasheet are Reach and RoHS compliant, and Halogen-Free.

As an environmentally conscious company, KEMET is working continuously with improvements concerning the environmental effects of both our capacitors and their production. In Europe (RoHS Directive) and in some other geographical areas like China, legislation has been put in place to prevent the use of some hazardous materials, such as lead (Pb), in electronic equipment. All products in this catalog are produced to help our customers' obligations to guarantee their products and fulfill these legislative requirements. The only material of concern in our products has been lead (Pb), which has been removed from all designs to fulfill the requirement of containing less than 0.1% of lead in any homogeneous material. KEMET will closely follow any changes in legislation worldwide and makes any necessary changes in its products, whenever needed.

Some customer segments such as medical, military and automotive electronics may still require the use of lead in electrode coatings. To clarify the situation and distinguish products from each other, a special symbol is used on the packaging labels for RoHS compatible capacitors.

Due to customer requirements, there may appear additional markings such as LF = Lead-free or LFW = Lead-free wires on the label.

Table 1 – Ratings & Part Number Reference

VDC	VDC Surge Voltage	Rated Capacitance 120 Hz 20°C (µF)	Case Size D x L (mm)	ESR 100 kHz 20°C (mΩ)	RC 100 kHz 105°C (mA)	RC 100 kHz 125°C (mA)	LC 20°C 2 minutes (µA)	KEMET Part Number
6.3	7.245	220	6.3 x 8	18	3098	1791	207.9	A759EK227M0J(1)E018
6.3	7.245	470	6.3 x 8	16	4100	2370	444.15	A759EK477M0J(1)E016
6.3	7.245	680	8 x 12	14	4844	2800	642.6	A759KS687M0J(1)E014
6.3	7.245	1000	8 x 12	13	5363	3100	945	A759KS108M0J(1)E013
6.3	7.245	1500	10 x 12	13	7093	4100	1417.5	A759MS158M0J(1)E013
6.3	7.245	2200	10 x 12	13	7785	4500	2079	A759MS228M0J(1)E013
10	11.5	220	6.3 x 8	18	1903	1100	330	A759EK227M1A(1)E018
10	11.5	330	6.3 x 8	18	2699	1560	495	A759EK337M1A(1)E018
10	11.5	470	8 x 12	14	4844	2800	705	A759KS477M1A(1)E014
10	11.5	820	8 x 12	13	5190	3000	1230	A759KS827M1A(1)E013
10	11.5	1000	10 x 12	12	7093	4100	1500	A759MS108M1A(1)E012
10	11.5	1500	10 x 12	12	7785	4500	2250	A759MS158M1A(1)E012
16	18.4	100	6.3 x 8	18	1903	1100	240	A759EK107M1C(1)E018
16	18.4	220	8 x 12	15	4429	2560	528	A759KS227M1C(1)E015
16	18.4	330	8 x 12	15	4429	2560	792	A759KS337M1C(1)E015
16	18.4	470	10 x 12	15	5363	3100	1128	A759MS477M1C(1)E015
16	18.4	560	10 x 12	15	6055	3500	1344	A759MS567M1C(1)E015
25	28.75	100	8 x 12	25	1817	1050	375	A759KS107M1E(1)E025
25	28.75	150	8 x 12	25	1990	1150	562.5	A759KS157M1E(1)E025
25	28.75	220	10 x 12	22	3633	2100	825	A759MS227M1E(1)E022
25	28.75	220	8 x 12	25	2699	1560	825	A759KS227M1E(1)E025
25	28.75	330	10 x 12	22	4429	2560	1237.5	A759MS337M1E(1)E022
25	28.75	470	10 x 12	20	4844	2800	1762.5	A759MS477M1E(1)E020
35	40.3	10	5 x 11	90	340	200	120	A759BQ106M1V(1)E090
35	40.3	22	5 x 11	80	600	350	120	A759BQ226M1V(1)E080
35	40.3	33	5 x 11	75	690	400	173	A759BQ336M1V(1)E075
35	40.3	100	8 x 12	31	4290	2500	525	A759KS107M1V(1)E031
35	40.3	150	10 x 12	30	4630	2700	788	A759MS157M1V(1)E030
35	40.3	180	8 x 11.5	24	3,400	2,000	1260	A759KR187M1V(1)E024
35	40.3	220	8 x 11.5	24	3,400	2,000	1540	A759KR227M1V(1)E024
35	40.3	270	10 x 12.5	22	3,740	2,200	1890	A759MU277M1V(1)E022
35	40.3	330	10 x 12.5	22	3,740	2,200	2310	A759MU337M1V(1)E022
50	57.5	10	5 x 11	105	380	220	120	A759BQ106M1H(1)E105
50	57.5	22	5 x 11	75	560	310	165	A759BQ226M1H(1)E075
50	57.5	39	8 x 12	42	1630	950	293	A759KS396M1H(1)E042
50	57.5	68	10 x 12	32	2300	1440	510	A759MS686M1H(1)E032
50	57.5	100	10 x 12	31	2830	1650	750	A759MS107M1H(1)E031
50	57.5	440	10 x 18	28	6010	3500	3300	A759MX447M1H(1)E028
50	57.5	680	13 x 20	26	6520	3800	5100	A759PY687M1H(1)E026
VDC	VDC Surge	Rated Capacitance	Case Size	ESR	RC	RC	LC	Part Number

(1) Please see packaging codes for options.

(2) Electrical Parameters code. See Part Number System for available options.

Table 1 – Ratings & Part Number Reference cont.

VDC	VDC Surge Voltage	Rated Capacitance 120 Hz 20°C (µF)	Case Size D x L (mm)	ESR 100 kHz 20°C (mΩ)	RC 100 kHz 105°C (mA)	RC 100 kHz 125°C (mA)	LC 20°C 2 minutes (µA)	KEMET Part Number
63	72.5	10	6.3 x 5	60	1,658	975	126	A759EA106M1J(1)E060
63	72.5	12	6.3 x 5	60	1,658	975	151	A759EA126M1J(1)E060
63	72.5	22	6.3 x 8	54	1,998	1,175	277	A759EK226M1J(1)E054
63	72.5	22	8 x 6	54	1,998	1,175	277	A759KC226M1J(1)E054
63	72.5	27	6.3 x 8	54	1,998	1,175	340	A759EK276M1J(1)E054
63	72.5	27	8 x 6	54	1,998	1,175	340	A759KC276M1J(1)E054
63	72.5	33	8 x 8	36	2,720	1,600	416	A759KK336M1J(1)E036
63	72.5	39	8 x 8	36	2,720	1,600	491	A759KK396M1J(1)E036
63	72.5	47	8 x 12	68	1630	950	444	A759KS476M1J(1)E068
63	72.5	68	10 x 12	47	1970	1150	643	A759MS686M1J(1)E047
63	72.5	82	10 x 12	50	2500	1380	775	A759MS826M1J(1)E050
63	72.5	150	10 x 16	48	2610	1520	1418	A759MW157M1J(1)E048
63	72.5	220	10 x 20	45	3600	2100	2079	A759MY227M1J(1)E045
63	72.5	330	13 x 20	42	4030	2350	3119	A759PY337M1J(1)E042
80	92	10	8 x 8	75	952	550	120	A759KK106M1K(1)E075
80	92	18	8 x 8	75	1,055	610	216	A759KK186M1K(1)E075
80	92	33	8 x 12	55	1,839	1,063	396	A759KS336M1K(1)E055
80	92	47	8 x 12	45	2,163	1,250	564	A759KS476M1K(1)E045
80	92	56	10 x 12	45	2,630	1,520	672	A759MS566M1K(1)E045
100	115	4.7	6.3 x 11	160	510	300	120	A759EQ475M2A(1)E160
100	115	15	8 x 12	52	1,850	680	225	A759KS156M2A(1)E052
100	115	22	10 x 12	45	2,300	720	330	A759MS226M2A(1)E045
160	184	10	8 x 12	110	1,350	550	240	A759KS106M2C(1)E110
160	184	15	10 x 12	94	1,580	685	360	A759MS156M2C(1)E094
160	184	18	10 x 12	90	1,944	720	432	A759MS186M2C(1)E090
250	287.5	2.2	8 x 8	685	210	70	120	A759KK225M2E(1)E685
250	287.5	3.3	8 x 12	512	450	175	124	A759KS335M2E(1)E512
250	287.5	4.7	8 x 12	496	650	210	176	A759KS475M2E(1)E496
250	287.5	6.8	10 x 12	482	780	250	255	A759MS685M2E(1)E482
250	287.5	8.2	10 x 12	458	950	315	308	A759MS825M2E(1)E458
250	287.5	82	18 x 31	150	3,200	1,750	3075	A759SZ826M2E(1)E150
250	287.5	220	22 x 45	250	1,800	1,000	8250	A759TC227M2E(1)E250
VDC	VDC Surge	Rated Capacitance	Case Size	ESR	RC	RC	LC	Part Number

(1) Please see packaging codes for options.

(2) Electrical Parameters code. See Part Number System for available options.

Installing

Solid Polymer Aluminum Capacitors are prone to a change in leakage current due to thermal stress during soldering. The leakage current may increase after soldering or reflow soldering. Therefore, verify the suitability for use in circuits sensitive to leakage current.

A general principle is that lower temperature operation results in a longer, useful life of the capacitor. For this reason, it should be ensured that electrolytic capacitors are placed away from heat-emitting components. Adequate space should be allowed between components for cooling air to circulate, especially when high ripple current loads are applied. In any case, the maximum rated temperature must not be exceeded.

- Do not deform the case of capacitors or use capacitors with a deformed case.
- Verify that the connections of the capacitors are able to insert on the board without excessive mechanical force. Excessive force during insertion, as well as after soldering may cause terminal damage and affect the electrical performance.
- Ensure electrical insulation between the capacitor case, negative terminal, positive terminal and PCB.
- If the capacitors require mounting through additional means, the recommended mounting accessories shall be used.
- Verify the correct polarization of the capacitor on the board.

KEMET recommends, to ensure that the voltage across each capacitor does not exceed its rated voltage.

Temperature Stability Characteristics

Stable characteristics in a very low temperature range allows for less circuits in the design.

Due to a solid polymer electrolyte, Solid Polymer Aluminum Capacitors feature higher conductivity. This results in a lower ESR which, coupled with high capacitance allows an aluminum polymer capacitor to replace several standard electrolytic capacitors, reducing the number of components and maximizing board space.

The ESR of polymer capacitors is nearly constant within its operating temperature range, while the ESR of a standard electrolytic capacitor noticeably changes with temperature.

Temperature Stability Characteristics

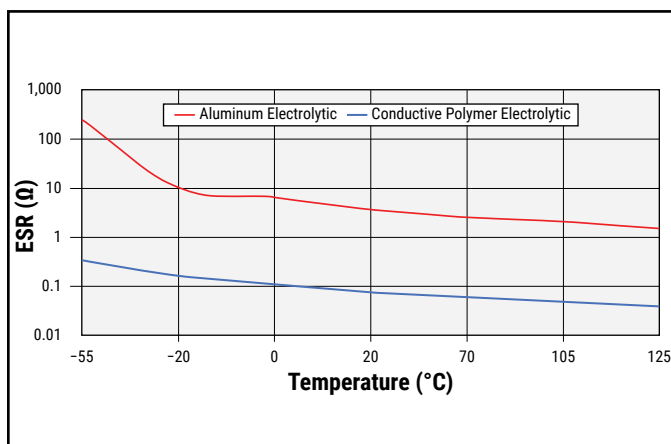

Stability of ESR across Frequency Range

Due to a solid polymer electrolyte, the ESR curve of a solid polymer aluminum capacitor, is lower and more stable than that of a standard electrolytic capacitor.

Stable ESR Values across Frequency

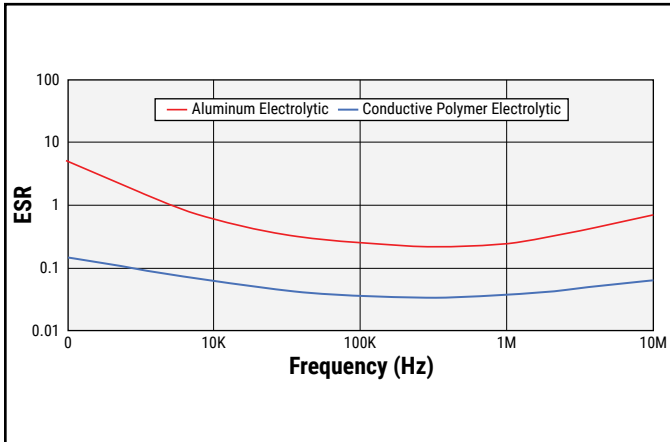

High Resistance to Ripple Current

As a result of a lower ESR, solid polymer aluminum capacitors are able to withstand higher ripple currents during normal operation.

Allowable Ripple Current (100 kHz 105°C)

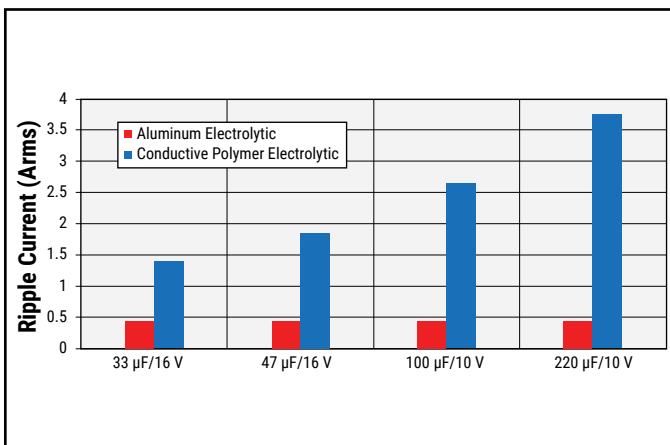

Marking

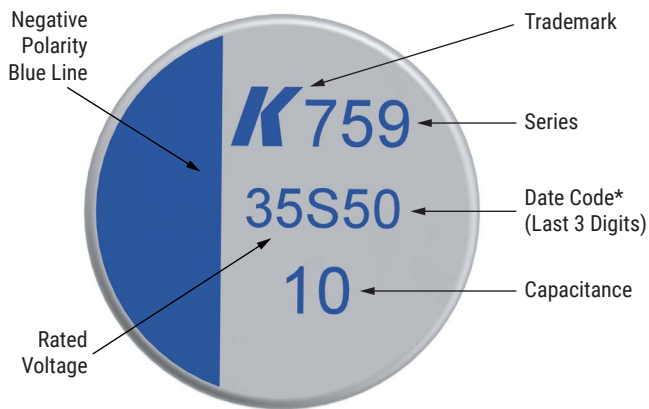

Date Code*	
1 st Digits = Rated Voltage	
Letter = Year Code	S = 2019
Final Digits = Week of the Year	01 = 1 st week of the Year to 52 = 52 nd week of the Year
Year Code	
S	2019
T	2020
U	2021
V	2022
W	2023
X	2024
Y	2025
Z	2026

Note: Sizes utilizing PET sleeve have printing on the sleeve rather than the top. The sleeve color can vary but is normally a blue/purple color.

Construction

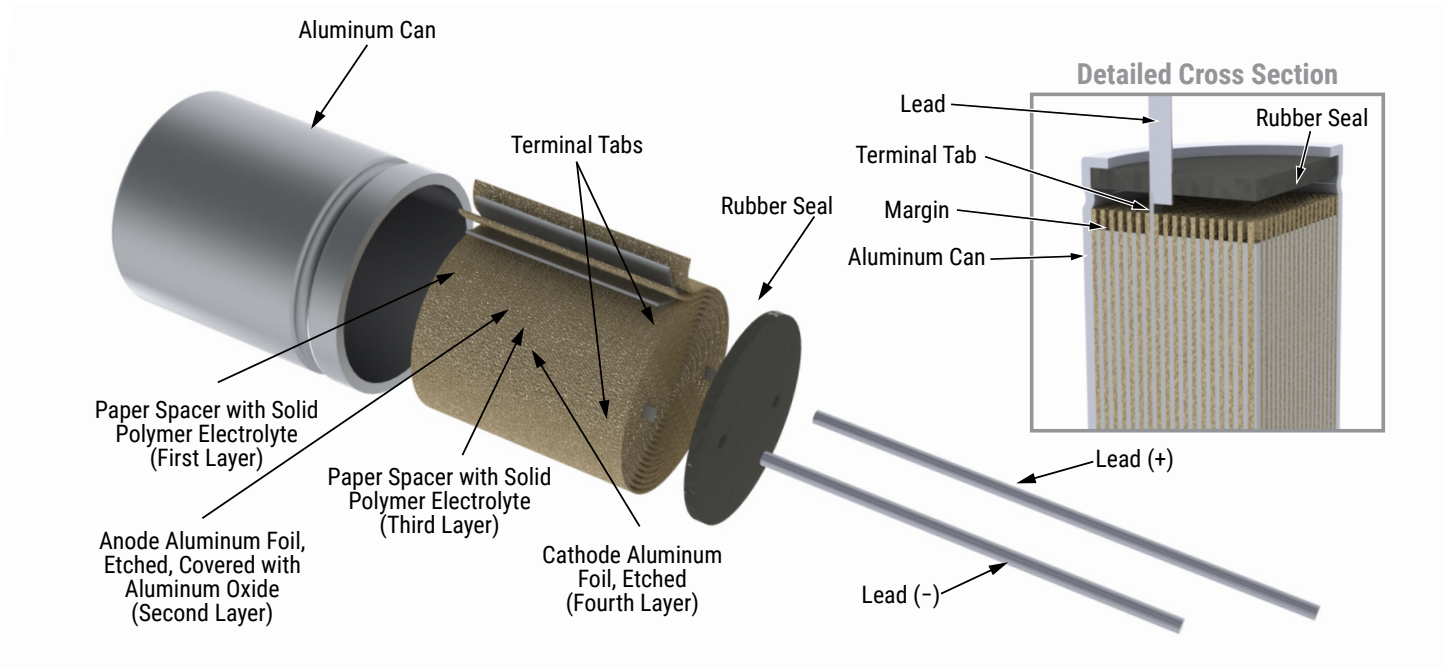

Flow Soldering (not suitable for SMD parts)

The soldering conditions should be within the specified conditions below:

- Do not dip the capacitors body into the melted solder.
- Flux should only be applied to the capacitors' terminals.
- Vapour heat transfer systems are not recommended. The system should be thermal, such as infra-red radiation or hot blast.
- Observe the soldering conditions as shown below.
- Do not exceed these limits and avoid repeated reflowing.

Flow Soldering

	Temperature (°C)	Maximum Time (Seconds)	Maximum Repetitions
Pre-heat	< 120	< 120	1
Solder	260±5°C	< 10	2

Taping for Automatic Insertion Machines

Fig. 1 (Diameter $\Phi 5$) 5 mm formed to 2.5 mm FA

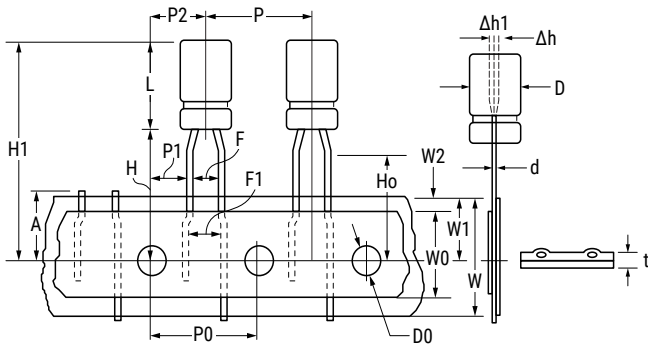

Fig. 2 (Diameter for $\Phi 5$ to $\Phi 8$) 5 – 8 mm formed to 5 mm DA

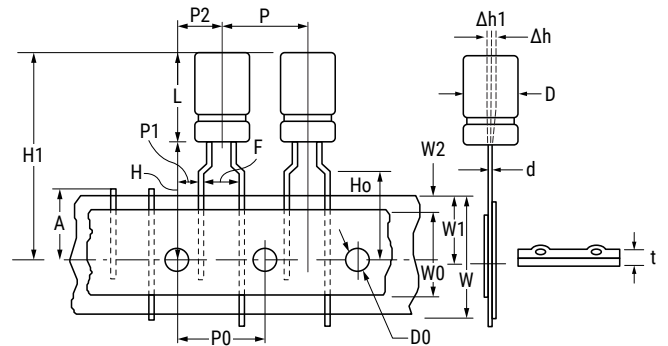

Fig. 3 (Diameter for $\Phi 6$ to $\Phi 8$) 6 – 8 mm EA

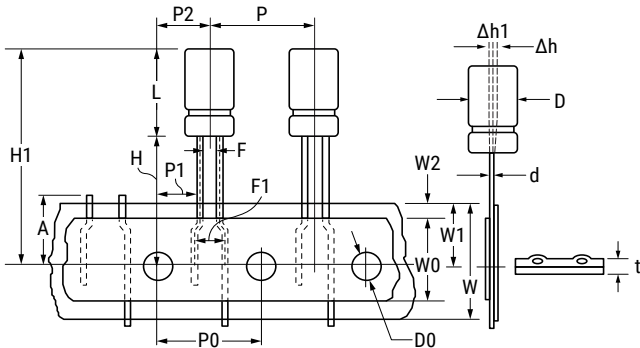
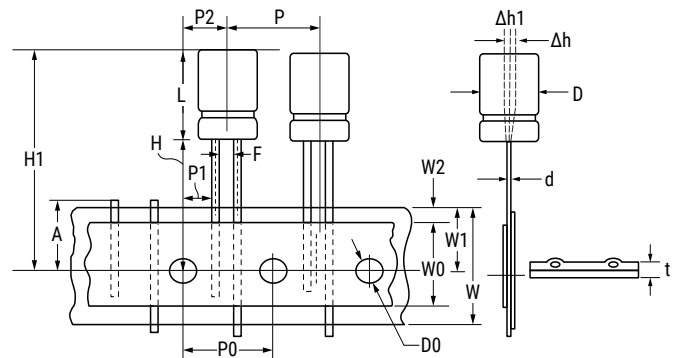

Fig. 4 (Diameter for $\Phi 10$) 10 mm EA



Dimensions (mm)	D	L	d	P	P0	P1	P2	F	W	W0	W1	W2	H	Ho	D0	A	H1	Δh	$\Delta h1$	t
Tolerance	± 0.5		± 0.02	± 1.0	± 0.2	± 0.7	± 1.0	± 0.5	± 0.5	Min.	± 0.5	Max.	± 0.75	± 0.5	± 0.2	Max.	Max.	± 2	± 1	± 0.3
Formed to 2.5 mm	5	$\frac{7.0}{9-11}$	0.5	12.7	12.7	5.1	6.35	2.5	18	12.5	9	1.5	17.5	16						
Formed to 5 mm	5	7-11	0.5	12.7	12.7	3.85	6.35	5	18	12.5	9	1.5	18.5	16			32.5			
	6.3	8-11																		
Straight leads 6 – 8 mm	8	$\frac{8.0}{12.0}$	0.6	12.7	12.7	5.4	6.35	2.5	18	12.5	9	1.5	18.5		4	11		0	0	0.7
	8	8-11	3.5					20												
Straight leads 10 – 13 mm	10	12	0.6	12.7	12.7	3.85	6.35	5	18	12.5	9	1.5	18.5	--			33			
		16.0															36			
		18.0															41			
		20.0															40.5			
	13	20.0		15	15	5	7.5													

Construction Data

The manufacturing process begins with the anode foil being electrochemically etched to increase the surface area and then 'formed' to produce the aluminum oxide layer. Both the anode and cathode foils are then interleaved with absorbent paper and wound into a cylinder. During the winding process, aluminum tabs are attached to each foil to provide the electrical contact.

The deck, complete with terminals, is attached to the tabs and then folded down to rest on top of the winding. The complete winding is impregnated with a conductive polymer electrolyte before being housed in a suitable container, usually an aluminum can, and sealed. Throughout the process, all materials inside the housing must be maintained at the highest purity and be compatible with the electrolyte.

Each capacitor is aged and tested before being packed. The purpose of aging is to repair any damage in the oxide layer and thus reduce the leakage current to a very low level. Aging is normally carried out at the rated temperature of the capacitor and is accomplished by applying voltage to the device while carefully controlling the supply current. The process may take several hours to complete. Damage to the oxide layer can occur due to variety of reasons:

- Slitting of the anode foil after forming
- Attaching the tabs to the anode foil
- Minor mechanical damage caused during winding

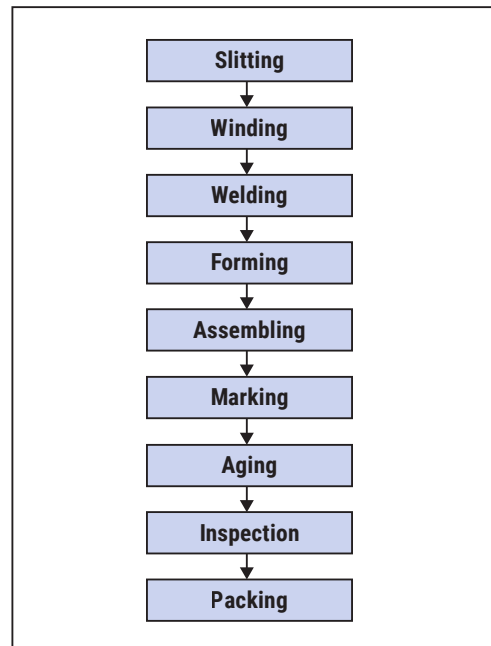
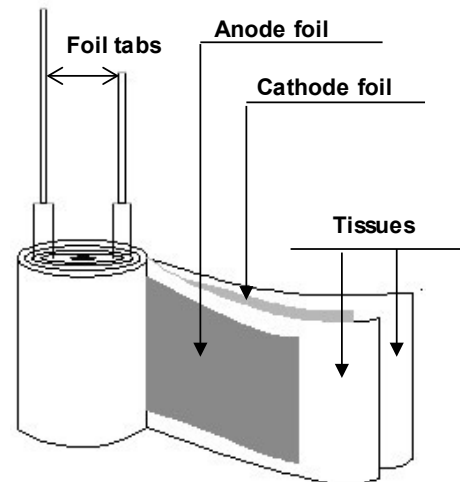

Product Safety

THESE NOTES SHOULD BE READ IN CONJUNCTION WITH THE PRODUCT DATA SHEET. FAILURE TO OBSERVE THE RATINGS AND THE INFORMATION ON THIS SHEET MAY RESULT IN A SAFETY HAZARD.

Warning

When potential lethal voltages e.g. 30 VAC (RMS) or 60 VDC are applied to the terminals of this product, the use of a hazard warning label is recommended.

1. Electrolyte

Conductive polymer aluminum solid electrolytic capacitors contain polymers (electrolytes) which can be hazardous.

1.1 Safety Precautions

In the event of gas venting, avoid contact and inhalation. Wash the affected area with hot water. Use rubber gloves to avoid skin contact. Any contact with the eyes should be liberally irrigated with water and medical advice sought.

2. Intrinsic Properties

2.1 Operating

DC capacitors are polar devices and will operate safely only if correctly connected. Reversing the connections will result in high leakage currents which could subsequently cause short circuit failure and possibly explosion and fire. Correctly polarized operation may result in the above failure modes if:

- The surge voltage is exceeded
- The ambient temperature is too high
- Excessive ripple currents are applied

2.2 Non-Operating

Excessive torque or soldering heat may affect the performance of the capacitor or damage the sealing. Electric shock may result if capacitors are not discharged.

3. Disposal

Aluminum electrolytic capacitors are consignable waste under the Special Waste Regulations 1996 (Statutory Instrument 1996 No 972), which complies with the EC Hazardous Waste Directive – Directive 91/689/EEC. The electrolyte should therefore be treated as a hazardous waste and advice should be sought from the local office of the Environmental Agency regarding its disposal.

Due to the construction of an aluminum electrolytic capacitors, high temperature incineration may cause the component to explode due to build-up of internal pressure. In addition, incineration may also cause the emission of noxious fumes. KEMET strongly recommends that if there are any doubts regarding the disposal of conductive polymer aluminum solid electrolytic capacitors, that advice be sought from the local regulating authority.

In addition, KEMET would like to request that users of aluminum electrolytic capacitors respect the needs of the environment and, wherever possible, recover as much of the materials as possible, i.e., aluminum.

Product Safety cont.

4. Unsafe Use

Most failures are of a passive nature and do not represent a safety hazard. A hazard may, however, arise if this failure causes a dangerous malfunction of the equipment in which the capacitor is employed. Circuits should be designed to fail safe under the normal modes of failure.

The usual failure mode is an increase in leakage current or short circuit. Other possible modes are decrease of capacitance, increase in dissipation factor (and impedance) or an open circuit. Capacitors should be used in a well-ventilated enclosure or cabinet.

5. Fumigation

In many countries throughout the world it is now common practice to fumigate shipments of products in order to control insect infestation, particularly when wooden packaging is used. Currently, methyl bromide is widely used as a fumigant, which can penetrate cardboard packing and polymer bags and, therefore, come into direct contact with equipment or components contained within.

If aluminum electrolytic capacitors become exposed to methyl bromide then corrosion may occur, depending upon the concentration and exposure time to the chemical.

This failure mode can affect all types of KEMET aluminum electrolytic capacitors. Methyl bromide can penetrate the seals of aluminum electrolytic capacitors and cause internal corrosion of the anode connection, resulting in the component becoming open circuit. The rate of corrosion will depend upon the level of exposure to methyl bromide as well as the subsequent operating conditions, such as voltage and temperature. It may take months or, in some cases, several years before the component becomes open circuit.

6. Dielectric Absorption

A phenomenon known as dielectric absorption can cause aluminum electrolytic capacitors to recharge themselves. The phenomenon is well known but impossible to predict with any great accuracy, so potentially any electrolytic product could be affected. Thus, a capacitor that has been charged and then completely discharged will appear to recharge itself if left open circuit; this will manifest itself as a small voltage across the terminals of the capacitor. Generally, the voltages seen are less than 20 VDC. However, higher voltages have on occasion been reported.

In order to avoid any problems caused by this voltage, KEMET recommends that capacitors be discharged before connecting to the terminals.

KEMET Electronics Corporation Sales Offices

For a complete list of our global sales offices, please visit www.kemet.com/sales.

Disclaimer

YAGEO Corporation and its affiliates do not recommend the use of commercial or automotive grade products for high reliability applications or manned space flight.

All product specifications, statements, information and data (collectively, the "Information") in this datasheet are subject to change. The customer is responsible for checking and verifying the extent to which the Information contained in this publication is applicable to an order at the time the order is placed. All Information given herein is believed to be accurate and reliable, but it is presented without guarantee, warranty, or responsibility of any kind, expressed or implied.

Statements of suitability for certain applications are based on KEMET Electronics Corporation's ("KEMET") knowledge of typical operating conditions for such applications, but are not intended to constitute – and KEMET specifically disclaims – any warranty concerning suitability for a specific customer application or use. The Information is intended for use only by customers who have the requisite experience and capability to determine the correct products for their application. Any technical advice inferred from this Information or otherwise provided by KEMET with reference to the use of KEMET's products is given gratis, and KEMET assumes no obligation or liability for the advice given or results obtained.

Although KEMET designs and manufactures its products to the most stringent quality and safety standards, given the current state of the art, isolated component failures may still occur. Accordingly, customer applications which require a high degree of reliability or safety should employ suitable designs or other safeguards (such as installation of protective circuitry or redundancies) in order to ensure that the failure of an electrical component does not result in a risk of personal injury or property damage.

Although all product-related warnings, cautions and notes must be observed, the customer should not assume that all safety measures are indicated or that other measures may not be required.

KEMET requires its products to be packaged and shipped on pallets. This is because KEMET's products are specifically designed to be packed onto pallets during shipment. If for any reason, the products are removed from pallets by the shipping party and shipped to the end customer, then additional external protection is required. In this instance, an external box with two carton layers and an upwards orientation sticker must be used by the shipping party, with the empty space filled with filling material, and afterwards sealing the box. If this packing and packaging guideline is not followed by the shipping party, the shipping party, and not KEMET, will be held responsible for any packaging, packing and/or product damages upon delivery of the products to the end customer. KEMET hereby disclaims any liability for damages to the products or otherwise that have been, or threaten to be, inflicted, result from or are in any way related to the packaging, packing or damage by the shipping party in contravention of the packing and packaging guidelines herein.

KEMET is a registered trademark of KEMET Electronics Corporation.

Looking for pricing, stock, or lifecycle information?

Click below to explore more details on WIN SOURCE:

 [View A759PY337M1JAAE042 on WIN SOURCE](#)

 [Kemet Information](#)

Optimize Your Supply Chain with WIN SOURCE Solutions

-  Global Sourcing Solution
-  Obsolete Management
-  Cost Control Management
-  Shortage Management
-  Alternative Solution
-  Excess Inventory Management