



**THE DATASHEET OF
TMCS1101A4UQDR**



TMCS1101 1.5% Precision, Basic Isolation Hall-Effect Current Sensor With ± 600 -V Working Voltage

1 Features

- Total error: $\pm 0.51\%$ typical, $\pm 1.15\%$ maximum, -40°C to 85°C
 - Sensitivity error: $\pm 0.5\%$
 - Offset error: 9 mA
 - Offset drift: $0.04\text{ mA}/^{\circ}\text{C}$
 - Linearity error: 0.05%
- Lifetime and environmental drift: $< \pm 0.5\%$
- 3-kV_{RMS} isolation rating
- Robust 600-V lifetime working voltage
- Bidirectional and unidirectional current sensing
- Zero drift internal reference
- Operating supply range: 3 V to 5.5 V
- Signal bandwidth: 80 kHz
- Multiple sensitivity options:
 - TMCS1101A1B/U: 50 mV/A
 - TMCS1101A2B/U: 100 mV/A
 - TMCS1101A3B/U: 200 mV/A
 - TMCS1101A4B/U: 400 mV/A
- Safety related certifications
 - UL 1577 Component Recognition Program
 - IEC/CB 62368-1

2 Applications

- Motor and load control
- Inverter and H-bridge current measurements
- Power factor correction
- Overcurrent protection
- DC and AC power monitoring

3 Description

The TMCS1101 is a galvanically isolated Hall-effect current sensor capable of DC or AC current measurement with high accuracy, excellent linearity, and temperature stability. A low-drift, temperature-compensated signal chain provides $< 1.5\%$ full-scale error across the device temperature range.

The input current flows through an internal 1.8-m Ω conductor that generates a magnetic field measured by an integrated Hall-effect sensor. This structure eliminates external concentrators and simplifies design. Low conductor resistance minimizes power loss and thermal dissipation. Inherent galvanic insulation provides a 600-V lifetime working voltage and 3-kV_{RMS} basic isolation between the current path and circuitry. Integrated electrical shielding enables excellent common-mode rejection and transient immunity.

The output voltage is proportional to the input current with four sensitivity options. Fixed sensitivity allows the TMCS1101 to operate from a single 3-V to 5.5-V power supply, eliminates ratiometry errors, and improves supply noise rejection. The current polarity is considered positive when flowing into the positive input pin. Both unidirectional and bidirectional sensing variants are available.

The TMCS1101 draws a maximum supply current of 6 mA, and all sensitivity options are specified over the operating temperature range of -40°C to $+125^{\circ}\text{C}$.

Device Information⁽¹⁾

PART NUMBER	PACKAGE	BODY SIZE (NOM)
TMCS1101	SOIC (8)	4.90 mm \times 3.90 mm

(1) For all available packages, see the package option addendum at the end of the data sheet.

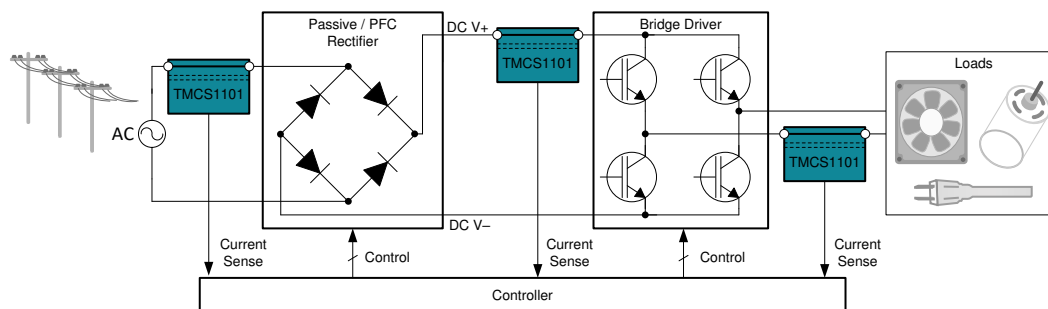

Typical Application



Table of Contents

1 Features	1	9.1 Overview.....	24
2 Applications	1	9.2 Functional Block Diagram.....	24
3 Description	1	9.3 Feature Description.....	24
4 Revision History	2	9.4 Device Functional Modes.....	30
5 Device Comparison	3	10 Application and Implementation	31
6 Pin Configuration and Functions	3	10.1 Application Information.....	31
7 Specifications	4	10.2 Typical Application.....	34
7.1 Absolute Maximum Ratings	4	11 Power Supply Recommendations	35
7.2 ESD Ratings	4	12 Layout	36
7.3 Recommended Operating Conditions	4	12.1 Layout Guidelines.....	36
7.4 Thermal Information	4	12.2 Layout Example.....	37
7.5 Power Ratings	5	13 Device and Documentation Support	38
7.6 Insulation Specifications	5	13.1 Device Support.....	38
7.7 Safety-Related Certifications	6	13.2 Documentation Support.....	38
7.8 Safety Limiting Values	6	13.3 Receiving Notification of Documentation Updates..	38
7.9 Electrical Characteristics	7	13.4 Support Resources.....	38
7.10 Typical Characteristics.....	10	13.5 Trademarks.....	38
8 Parameter Measurement Information	16	13.6 Electrostatic Discharge Caution.....	38
8.1 Accuracy Parameters.....	16	13.7 Glossary.....	38
8.2 Transient Response Parameters.....	19	14 Mechanical, Packaging, and Orderable Information	38
8.3 Safe Operating Area.....	21		
9 Detailed Description	24		

4 Revision History

Changes from Revision C (June 2020) to Revision D (July 2021)	Page
• Updated the numbering format for tables, figures, and cross-references throughout the document	1
• Removed 'planned' from the safety related certifications bullet in the <i>Features</i> section.....	1
Changes from Revision B (June 2020) to Revision C (June 2020)	Page
• Changed TMCS110AxU orderable statuses from <i>Advanced Information</i> to <i>Production Data</i>	1
Changes from Revision A (May 2020) to Revision B (June 2020)	Page
• Changed TMCS110AxB orderable statuses from <i>Advanced Information</i> to <i>Production Data</i>	1
Changes from Revision * (September 2019) to Revision A (May 2020)	Page
• Changed data sheet status from <i>Advanced Information</i> to <i>Production Mixed</i>	1

5 Device Comparison

Table 5-1. Device Comparison

PRODUCT	SENSITIVITY	ZERO CURRENT OUTPUT VOLTAGE,	I_{IN} LINEAR MEASUREMENT RANGE ⁽¹⁾	
	$\Delta V_{OUT} / \Delta I_{IN+}, IN-$	$V_{OUT,0A}$	$V_S = 5\text{ V}$	$V_S = 3.3\text{ V}$
TMCS1101A1B	50 mV/A	$0.5 \times V_S$	$\pm 46\text{ A}^{(2)}$	$\pm 29\text{ A}^{(2)}$
TMCS1101A2B	100 mV/A		$\pm 23\text{ A}^{(2)}$	$\pm 14.5\text{ A}$
TMCS1101A3B	200 mV/A		$\pm 11.5\text{ A}$	$\pm 7.25\text{ A}$
TMCS1101A4B	400 mV/A		$\pm 5.75\text{ A}$	--
TMCS1101A1U	50 mV/A	$0.1 \times V_S$	$-9\text{ A} \rightarrow 86\text{ A}^{(2)}$	$-5.6\text{ A} \rightarrow 55.4\text{ A}^{(2)}$
TMCS1101A2U	100 mV/A		$-4.5\text{ A} \rightarrow 43\text{ A}^{(2)}$	$-2.8\text{ A} \rightarrow 27.7\text{ A}^{(2)}$
TMCS1101A3U	200 mV/A		$-2.25\text{ A} \rightarrow 21.5\text{ A}^{(2)}$	$-1.4\text{ A} \rightarrow 13.85\text{ A}$
TMCS1101A4U	400 mV/A		$-1.12\text{ A} \rightarrow 10.75\text{ A}$	--

- (1) Linear range limited by swing to supply and ground.
(2) Current levels must remain below both allowable continuous DC/RMS and transient peak current safe operating areas to not exceed device thermal limits. See the [Safe Operating Area](#) section.

6 Pin Configuration and Functions

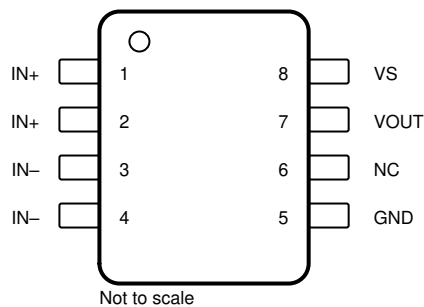

Figure 6-1. D Package 8-Pin SOIC Top View

Table 6-1. Pin Functions

PIN		I/O	DESCRIPTION
NO.	NAME		
1	IN+	Analog input	Input current positive pin
2	IN+	Analog input	Input current positive pin
3	IN-	Analog input	Input current negative pin
4	IN-	Analog input	Input current negative pin
5	GND	Analog	Ground
6	NC	No Connect	No connect. Pin can tolerate a capacitive or resistive connection to GND or VS (recommend short to GND if acceptable).
7	VOUT	Analog output	Output voltage
8	VS	Analog	Power supply

7 Specifications

7.1 Absolute Maximum Ratings

over operating free-air temperature range (unless otherwise noted)⁽¹⁾

		MIN	MAX	UNIT
V _S	Supply voltage	GND – 0.3	6	V
	NC Input	NC	(V _S) + 0.3	V
	Analog output	V _{OUT}	(V _S) + 0.3	V
T _J	Junction temperature	–65	150	°C
T _{stg}	Storage temperature	–65	150	°C

- (1) Stresses beyond those listed under *Absolute Maximum Ratings* may cause permanent damage to the device. These are stress ratings only, which do not imply functional operation of the device at these or any other conditions beyond those indicated under *Recommended Operating Conditions*. Exposure to absolute-maximum-rated conditions for extended periods may affect device reliability.

7.2 ESD Ratings

			VALUE	UNIT
V _(ESD)	Electrostatic discharge	Human-body model (HBM), per ANSI/ESDA/JEDEC JS-001 ⁽¹⁾	±2000	V
		Charged-device model (CDM), per JEDEC specification JESD22-C101 ⁽²⁾	±1000	

- (1) JEDEC document JEP155 states that 500-V HBM allows safe manufacturing with a standard ESD control process.
 (2) JEDEC document JEP157 states that 250-V CDM allows safe manufacturing with a standard ESD control process.

7.3 Recommended Operating Conditions

over operating free-air temperature range (unless otherwise noted)

		MIN	NOM	MAX	UNIT
V _{IN+} , V _{IN-}	Input voltage ⁽¹⁾	–600		600	V _{PK}
V _S	Operating supply voltage, TMCS1101A1B/U-A3B/U	3	5	5.5	V
V _S	Operating supply voltage, TMCS1101A4B/U	4.5	5	5.5	V
T _A	Operating free-air temperature ⁽²⁾	–40		125	°C

- (1) V_{IN+} and V_{IN-} refer to the voltage at input current pins IN+ and IN–, relative to pin 5 (GND).
 (2) Input current safe operating area is constrained by junction temperature. Recommended condition based on the [TMCS1101EVM](#). Input current rating is derated for elevated ambient temperatures.

7.4 Thermal Information

THERMAL METRIC ⁽¹⁾		TMCS1101 ⁽²⁾		UNIT
		D (SOIC)		
		8 PINS		
R _{θJA}	Junction-to-ambient thermal resistance	36.6		°C/W
R _{θJC(top)}	Junction-to-case (top) thermal resistance	50.7		°C/W
R _{θJB}	Junction-to-board thermal resistance	9.6		°C/W
Ψ _{JT}	Junction-to-top characterization parameter	–0.1		°C/W
Ψ _{JB}	Junction-to-board characterization parameter	11.7		°C/W
R _{θJC(bot)}	Junction-to-case (bottom) thermal resistance	N/A		°C/W

- (1) For more information about traditional and new thermal metrics, see the [Semiconductor and IC Package Thermal Metrics](#) application report.
 (2) Applies when device mounted on [TMCS1101EVM](#). For more details, see the [Safe Operating Area](#) section.

7.5 Power Ratings

$V_S = 5.5\text{ V}$, $T_A = 125^\circ\text{C}$, $T_J = 150^\circ\text{C}$, device soldered on [TMCS1101EVM](#).

PARAMETER		TEST CONDITIONS	MIN	TYP	MAX	UNIT
P_D	Maximum power dissipation (both sides)				673	mW
P_{D1}	Maximum power dissipation (current input, side-1)	$I_{IN} = 16\text{ A}$			640	mW
P_{D2}	Maximum power dissipation by (side-2)	$V_S = 5.5\text{ V}$, $I_Q = 6\text{ mA}$, no VOUT load			33	mW

7.6 Insulation Specifications

PARAMETER		TEST CONDITIONS	VALUE	UNIT
GENERAL				
CLR	External clearance ⁽¹⁾	Shortest terminal-to-terminal distance through air	4	mm
CPG	External creepage ⁽¹⁾	Shortest terminal-to-terminal distance across the package surface	4	mm
DTI	Distance through the insulation	Minimum internal gap (internal clearance)	60	μm
CTI	Comparative tracking index	DIN EN 60112; IEC 60112	>400	V
	Material group		II	
	Overvoltage category	Rated mains voltage $\leq 150\text{ V}_{\text{RMS}}$	I-IV	
		Rated mains voltage $\leq 300\text{ V}_{\text{RMS}}$	I-III	
V_{IORM}	Maximum repetitive peak isolation voltage	AC voltage (bipolar)	600	V_{PK}
V_{IOWM}	Maximum working isolation voltage	AC voltage (sine wave); Time Dependent Dielectric Breakdown test, see Insulation Lifetime .	424	V_{RMS}
		DC voltage	600	V_{DC}
V_{IOTM}	Maximum transient isolation voltage	$V_{\text{TEST}} = V_{IOTM} = 4242V_{\text{PK}}$, $t = 60\text{ s}$ (qualification); $V_{\text{TEST}} = 1.2 \times V_{IOTM} = 5090V_{\text{PK}}$, $t = 1\text{ s}$ (100% production)	4242	V_{PK}
V_{IOSM}	Maximum surge isolation voltage ⁽²⁾	Test method per IEC 62368-1, 1.2/50 μs waveform, $V_{\text{TEST}} = 1.3 \times V_{IOSM} = 7800V_{\text{PK}}$ (qualification)	6000	V_{PK}
q_{pd}	Apparent charge ⁽³⁾	Method a: After I/O safety test subgroup 2/3, $V_{\text{ini}} = V_{IOTM} = 4242V_{\text{PK}}$, $t_{\text{ini}} = 60\text{ s}$; $V_{\text{pd(m)}} = 1.2 \times V_{IORM} = 700V_{\text{PK}}$, $t_{\text{m}} = 10\text{ s}$	≤ 5	pC
		Method a: After environmental tests subgroup 1, $V_{\text{ini}} = V_{IOTM} = 4242V_{\text{PK}}$, $t_{\text{ini}} = 60\text{ s}$; $V_{\text{pd(m)}} = 1.2 \times V_{IORM} = 700V_{\text{PK}}$, $t_{\text{m}} = 10\text{ s}$	≤ 5	
		Method b3: At routine test (100% production) and preconditioning (type test) $V_{\text{ini}} = 1.2 \times V_{IOTM} = 5090V_{\text{PK}}$, $t_{\text{ini}} = 1\text{ s}$; $V_{\text{pd(m)}} = 1.2 \times V_{IOTM} = 5090V_{\text{PK}}$, $t_{\text{m}} = 1\text{ s}$	≤ 5	
C_{IO}	Barrier capacitance, input to output ⁽⁴⁾	$V_{IO} = 0.4 \sin(2\pi ft)$, $f = 1\text{ MHz}$	0.6	pF
R_{IO}	Isolation resistance, input to output ⁽⁴⁾	$V_{IO} = 500\text{ V}$, $T_A = 25^\circ\text{C}$	$>10^{12}$	Ω
		$V_{IO} = 500\text{ V}$, $100^\circ\text{C} \leq T_A \leq 125^\circ\text{C}$	$>10^{11}$	Ω
		$V_{IO} = 500\text{ V}$ at $T_S = 150^\circ\text{C}$	$>10^9$	Ω
	Pollution degree		2	
UL 1577				
V_{ISO}	Withstand isolation voltage	$V_{\text{TEST}} = V_{ISO}$, $t = 60\text{ s}$ (qualification); $V_{\text{TEST}} = 1.2 \times V_{ISO}$, $t = 1\text{ s}$ (100% production)	3000	V_{RMS}

- Apply creepage and clearance requirements according to the specific equipment isolation standards of an application. Take care to maintain the creepage and clearance distance of the board design to make sure that the mounting pads of the isolator on the printed-circuit board do not reduce this distance. Creepage and clearance on a printed-circuit board become equal in certain cases. Techniques such as inserting grooves, ribs, or both on a printed circuit board are used to help increase these specifications.
- Testing is carried out in air or oil to determine the intrinsic surge immunity of the isolation barrier.

- (3) Apparent charge is electrical discharge caused by a partial discharge (pd).
 (4) All pins on each side of the barrier tied together creating a two-terminal device

7.7 Safety-Related Certifications

UL	
UL 1577 Component Recognition Program	Certified according to IEC 62368-1 CB
File number: E181974	Certificate number: US-36733-UL

7.8 Safety Limiting Values

Safety limiting intends to minimize potential damage to the isolation barrier upon failure of input or output circuitry.

PARAMETER		TEST CONDITIONS	MIN	TYP	MAX	UNIT
I_S	Safety input current (side 1) ⁽¹⁾	$R_{\theta JA} = 36.6^\circ\text{C/W}$, $T_J = 150^\circ\text{C}$, $T_A = 25^\circ\text{C}$, see Thermal Derating Curve, Side 1 .			30	A
I_S	Safety input, output, or supply current (side 2) ⁽¹⁾	$R_{\theta JA} = 36.6^\circ\text{C/W}$, $V_I = 5\text{ V}$, $T_J = 150^\circ\text{C}$, $T_A = 25^\circ\text{C}$, see Thermal Derating Curve, Side 2 .			0.68	
P_S	Safety input, output, or total power ⁽¹⁾	$R_{\theta JA} = 36.6^\circ\text{C/W}$, $T_J = 150^\circ\text{C}$, $T_A = 25^\circ\text{C}$, see Thermal Derating Curve, Both Sides .			3.4	W
T_S	Safety temperature ⁽¹⁾				150	$^\circ\text{C}$

- (1) The maximum safety temperature, T_S , has the same value as the maximum junction temperature, T_J , specified for the device. The I_S and P_S parameters represent the safety current and safety power respectively. The maximum limits of I_S and P_S should not be exceeded. These limits vary with the ambient temperature, T_A .
 The junction-to-air thermal resistance, $R_{\theta JA}$, in the [Thermal Information](#) table is that of a device installed on the [TMCS1101EVM](#). Use these equations to calculate the value for each parameter:
 $T_J = T_A + R_{\theta JA} \times P$, where P is the power dissipated in the device.
 $T_{J(\text{max})} = T_S = T_A + R_{\theta JA} \times P_S$, where $T_{J(\text{max})}$ is the maximum allowed junction temperature.
 $P_S = I_S \times V_I$, where V_I is the maximum input voltage.

7.9 Electrical Characteristics

at $T_A = 25^\circ\text{C}$, $V_S = 5\text{ V}$ (unless otherwise noted)

PARAMETERS		TEST CONDITIONS	MIN	TYP	MAX	UNIT
OUTPUT						
	Sensitivity ⁽⁷⁾	TMCS1101A1B		50		mV/A
		TMCS1101A2B		100		mV/A
		TMCS1101A3B		200		mV/A
		TMCS1101A4B		400		mV/A
		TMCS1101A1U		50		mV/A
		TMCS1101A2U		100		mV/A
		TMCS1101A3U		200		mV/A
		TMCS1101A4U		400		mV/A
	Sensitivity error	$0.05\text{ V} \leq V_{\text{OUT}} \leq V_S - 0.2\text{ V}$, $T_A = 25^\circ\text{C}$		±0.3%	±0.8%	
		TMCS1101A1U, $0.05\text{ V} \leq V_{\text{OUT}} \leq 3\text{ V}$, $T_A = 25^\circ\text{C}$		±0.3%	±0.8%	
	Sensitivity error, including lifetime and environmental drift ⁽⁵⁾	$0.05\text{ V} \leq V_{\text{OUT}} \leq V_S - 0.2\text{ V}$, $T_A = 25^\circ\text{C}$		-0.47%	±1.02%	
	Sensitivity error	$0.05\text{ V} \leq V_{\text{OUT}} \leq V_S - 0.2\text{ V}$, $T_A = -40^\circ\text{C}$ to $+85^\circ\text{C}$		±0.5%	±1%	
		TMCS1101A1U, $0.05\text{ V} \leq V_{\text{OUT}} \leq 3\text{ V}$, $T_A = -40^\circ\text{C}$ to $+85^\circ\text{C}$		±0.5%	±1%	
		$0.05\text{ V} \leq V_{\text{OUT}} \leq V_S - 0.2\text{ V}$, $T_A = -40^\circ\text{C}$ to $+125^\circ\text{C}$		±0.6%	±1.25%	
		TMCS1101A1U, $0.05\text{ V} \leq V_{\text{OUT}} \leq 3\text{ V}$, $T_A = -40^\circ\text{C}$ to $+125^\circ\text{C}$		±0.6%	±1.25%	
	Nonlinearity error	$V_{\text{OUT}} = 0.5\text{ V}$ to $V_S - 0.5\text{ V}$		±0.05%		
		TMCS1101A1U, $V_{\text{OUT}} = 0.5\text{ V}$ to 3 V		±0.05%		
V_{OE}	Output voltage offset error ⁽¹⁾	TMCS1101A1B		±1	±4.5	mV
		TMCS1101A2B		±1	±6	mV
		TMCS1101A3B		±1.3	±9	mV
		TMCS1101A4B		±2.4	±21	mV
		TMCS1101A1U		±1.2	±5	mV
		TMCS1101A2U		±1	±8	mV
		TMCS1101A3U		±2.3	±10	mV
		TMCS1101A4U		±12.4	±28	mV
	Output voltage offset drift	TMCS1101A1B, $T_A = -40^\circ\text{C}$ to $+125^\circ\text{C}$		±5.4	±14	μV/°C
		TMCS1101A2B, $T_A = -40^\circ\text{C}$ to $+125^\circ\text{C}$		±3.5	±21	μV/°C
		TMCS1101A3B, $T_A = -40^\circ\text{C}$ to $+125^\circ\text{C}$		±7.4	±37	μV/°C
		TMCS1101A4B, $T_A = -40^\circ\text{C}$ to $+125^\circ\text{C}$		±27.6	±140	μV/°C
		TMCS1101A1U, $T_A = -40^\circ\text{C}$ to $+125^\circ\text{C}$		±7	±16	μV/°C
		TMCS1101A2U, $T_A = -40^\circ\text{C}$ to $+125^\circ\text{C}$		±9	±22	μV/°C
		TMCS1101A3U, $T_A = -40^\circ\text{C}$ to $+125^\circ\text{C}$		±14	±41	μV/°C
		TMCS1101A4U, $T_A = -40^\circ\text{C}$ to $+125^\circ\text{C}$		±36	±144	μV/°C

TMCS1101

SBOS825D – SEPTEMBER 2019 – REVISED JULY 2021

 at $T_A = 25^\circ\text{C}$, $V_S = 5\text{ V}$ (unless otherwise noted)

PARAMETERS		TEST CONDITIONS	MIN	TYP	MAX	UNIT
I_{OS}	Offset error, RTI ^{(1) (3)}	TMCS1101A1B		±20	±90	mA
		TMCS1101A2B		±10	±60	mA
		TMCS1101A3B		±6.5	±45	mA
		TMCS1101A4B		±6	±52.5	mA
		TMCS1101A1U		±24	±100	mA
		TMCS1101A2U		±10	±80	mA
		TMCS1101A3U		±11.5	±50	mA
		TMCS1101A4U		±31	±70	mA
	Offset error temperature drift, RTI ⁽³⁾	TMCS1101A1B, $T_A = -40^\circ\text{C}$ to $+125^\circ\text{C}$		±108	±280	$\mu\text{A}/^\circ\text{C}$
		TMCS1101A2B, $T_A = -40^\circ\text{C}$ to $+125^\circ\text{C}$		±35	±210	$\mu\text{A}/^\circ\text{C}$
		TMCS1101A3B, $T_A = -40^\circ\text{C}$ to $+125^\circ\text{C}$		±37	±185	$\mu\text{A}/^\circ\text{C}$
		TMCS1101A4B, $T_A = -40^\circ\text{C}$ to $+125^\circ\text{C}$		±69	±350	$\mu\text{A}/^\circ\text{C}$
		TMCS1101A1U, $T_A = -40^\circ\text{C}$ to $+125^\circ\text{C}$		±140	±320	$\mu\text{A}/^\circ\text{C}$
		TMCS1101A2U, $T_A = -40^\circ\text{C}$ to $+125^\circ\text{C}$		±90	±220	$\mu\text{A}/^\circ\text{C}$
		TMCS1101A3U, $T_A = -40^\circ\text{C}$ to $+125^\circ\text{C}$		±70	±205	$\mu\text{A}/^\circ\text{C}$
		TMCS1101A4U, $T_A = -40^\circ\text{C}$ to $+125^\circ\text{C}$		±90	±360	$\mu\text{A}/^\circ\text{C}$
PSRR	Power-supply rejection ratio	$V_S = 3\text{ V}$ to 5.5 V , TMCS1101A1B/U-A3B/U, $T_A = -40^\circ\text{C}$ to $+125^\circ\text{C}$		±1	±3	mV/V
		$V_S = 4.5\text{ V}$ to 5.5 V , TMCS1101A4B/U, $T_A = -40^\circ\text{C}$ to $+125^\circ\text{C}$		±1	±6.5	mV/V
CMTI	Common mode transient immunity			50		kV/ μs
CMRR	Common mode rejection ratio, RTI ⁽³⁾	DC to 60Hz		5		$\mu\text{A}/\text{V}$
	Zero current V_{OUT} ⁽¹⁾	TMCS1101A<1-4>U		$0.1 \cdot V_S$		V/V
	Zero current V_{OUT} ⁽¹⁾	TMCS1101A<1-4>B		$0.5 \cdot V_S$		V/V
	Noise density, RTI ⁽³⁾	TMCS1101A1B		380		$\mu\text{A}/\sqrt{\text{Hz}}$
		TMCS1101A2B		330		$\mu\text{A}/\sqrt{\text{Hz}}$
		TMCS1101A3B		300		$\mu\text{A}/\sqrt{\text{Hz}}$
		TMCS1101A4B		225		$\mu\text{A}/\sqrt{\text{Hz}}$
		TMCS1101A1U		380		$\mu\text{A}/\sqrt{\text{Hz}}$
		TMCS1101A2U		330		$\mu\text{A}/\sqrt{\text{Hz}}$
		TMCS1101A3U		300		$\mu\text{A}/\sqrt{\text{Hz}}$
		TMCS1101A4U		225		$\mu\text{A}/\sqrt{\text{Hz}}$
INPUT						
R_{IN}	Input conductor resistance	IN+ to IN-		1.8		m Ω
	Input conductor resistance temperature drift	$T_A = -40^\circ\text{C}$ to $+125^\circ\text{C}$		4.4		$\mu\Omega/^\circ\text{C}$
G	Magnetic coupling factor	$T_A = 25^\circ\text{C}$		1.1		mT/A
$I_{IN,max}$	Allowable continuous RMS current ⁽⁴⁾	$T_A = 25^\circ\text{C}$		30		A
		$T_A = 85^\circ\text{C}$		25		A
		$T_A = 105^\circ\text{C}$		22.5		A
		$T_A = 125^\circ\text{C}$		16		A
	NC (Pin 6) input impedance	Over allowable range, $\text{GND} < V_{NC} < V_S$		1		M Ω
VOLTAGE OUTPUT						
Z_{OUT}	Closed loop output impedance	$f = 1\text{ Hz}$ to 1 kHz		0.2		Ω
		$f = 10\text{ kHz}$		2		Ω
	Maximum capacitive load	No sustained oscillation		1		nF

at $T_A = 25^\circ\text{C}$, $V_S = 5\text{ V}$ (unless otherwise noted)

PARAMETERS		TEST CONDITIONS	MIN	TYP	MAX	UNIT
	Short circuit output current	V_{OUT} short to ground, short to V_S		90		mA
	Swing to V_S power-supply rail	$R_L = 10\text{ k}\Omega$ to GND, $T_A = -40^\circ\text{C}$ to $+125^\circ\text{C}$	$V_S - 0.02$		$V_S - 0.1$	V
	Swing to GND	$R_L = 10\text{ k}\Omega$ to GND, $T_A = -40^\circ\text{C}$ to $+125^\circ\text{C}$	$V_{GND} + 5$		$V_{GND} + 10$	mV

FREQUENCY RESPONSE

BW	Bandwidth ⁽⁶⁾	–3-dB Bandwidth		80		kHz
SR	Slew rate ⁽⁶⁾	Slew rate of output amplifier during single transient step.		1.5		V/ μs
t_r	Response time ⁽⁶⁾	Time between the input current step reaching 90% of final value to the sensor output reaching 90% of its final value, for a 1V output transition.		6.5		μs
t_p	Propagation delay ⁽⁶⁾	Time between the input current step reaching 10% of final value to the sensor output reaching 10% of its final value, for a 1V output transition.		4		μs
$t_{r,SC}$	Current overload response time ⁽⁶⁾	Time between the input current step reaching 90% of final value to the sensor output reaching 90% of its final value. Input current step amplitude is twice full scale output range.		5		μs
$t_{p,SC}$	Current overload propagation delay ⁽⁶⁾	Time between the input current step reaching 10% of final value to the sensor output reaching 10% of its final value. Input current step amplitude is twice full scale output range.		3		μs
	Current overload recovery time	Time from end of current causing output saturation condition to valid output		15		μs

POWER SUPPLY

I_Q	Quiescent current	$T_A = 25^\circ\text{C}$	4.5	5.5	mA
		$T_A = -40^\circ\text{C}$ to $+125^\circ\text{C}$		6	mA
	Power on time	Time from $V_S > 3\text{ V}$ to valid output	25		ms

- (1) Excludes effect of external magnetic fields. See the [Accuracy Parameters](#) section for details to calculate error due to external magnetic fields.
- (2) Excluding magnetic coupling from layout deviation from recommended layout. See the [Layout](#) section for more information.
- (3) RTI = referred-to-input. Output voltage is divided by device sensitivity to refer signal to input current. See the [Parameter Measurement Information](#) section.
- (4) Thermally limited by junction temperature. Applies when device mounted on [TMCS1101EVM](#). For more details, see the [Safe Operating Area](#) section.
- (5) Lifetime and environmental drift specifications based on three lot AEC-Q100 qualification stress test results. Typical values are population mean+1 σ from worst case stress test condition. Min/max are tested device population mean $\pm 6\sigma$; devices tested in AEC-Q100 qualification stayed within min/max limits for all stress conditions. See [Lifetime and Environmental Stability](#) section for more details.
- (6) Refer to the [Transient Response](#) section for details of frequency and transient response of the device.
- (7) Centered parameter based on [TMCS1101EVM](#) PCB layout. See [Layout](#) section. Device must be operated below maximum junction temperature.

7.10 Typical Characteristics

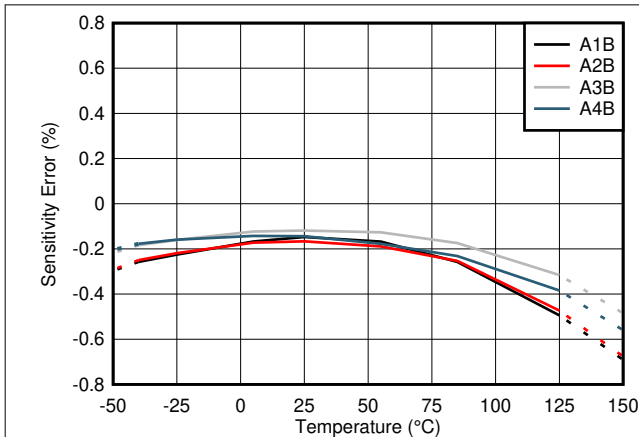

Figure 7-1. TMCS1101AxB Sensitivity Error vs Temperature

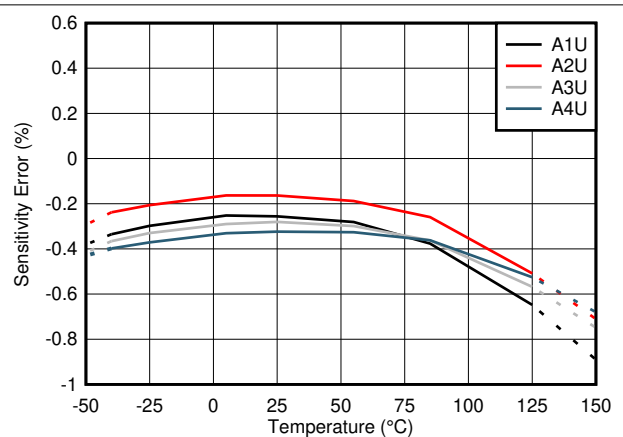

Figure 7-2. TMCS1101AxU Sensitivity Error vs Temperature

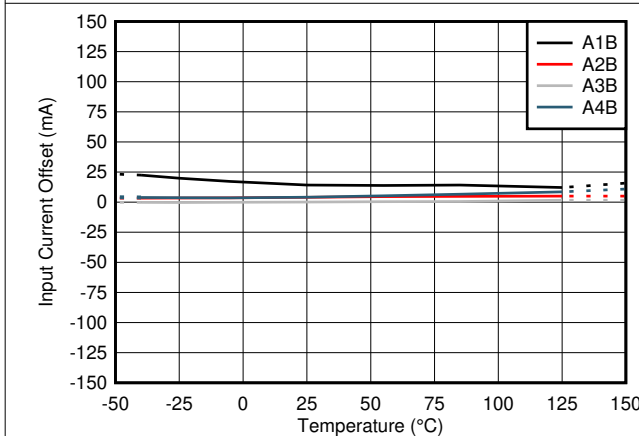

Figure 7-3. TMCS1101AxB Input Offset Current vs Temperature

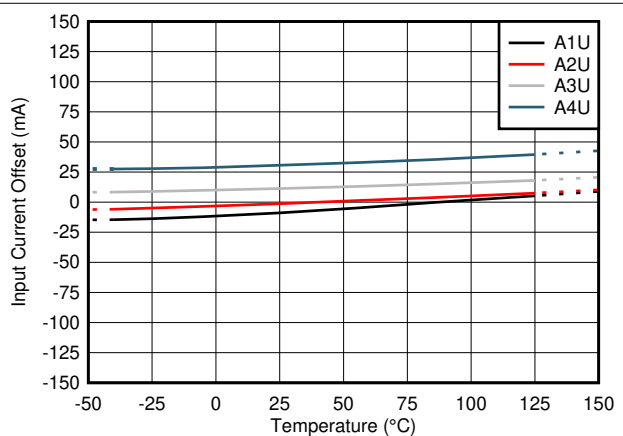

Figure 7-4. TMCS1101AxU Input Offset Current vs Temperature

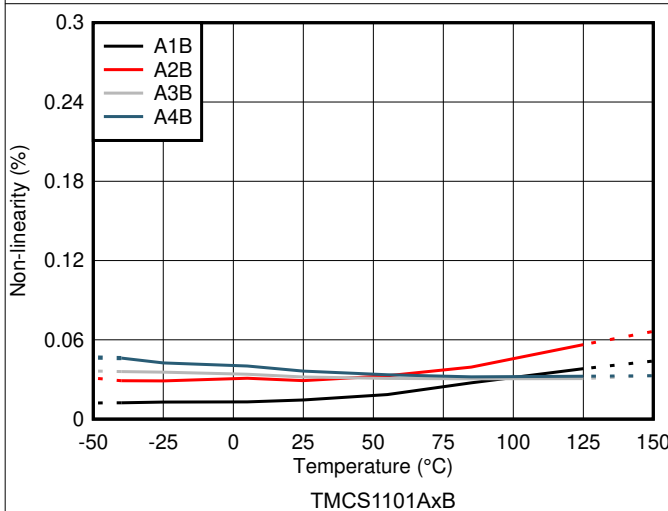

Figure 7-5. Non-Linearity vs. Temperature

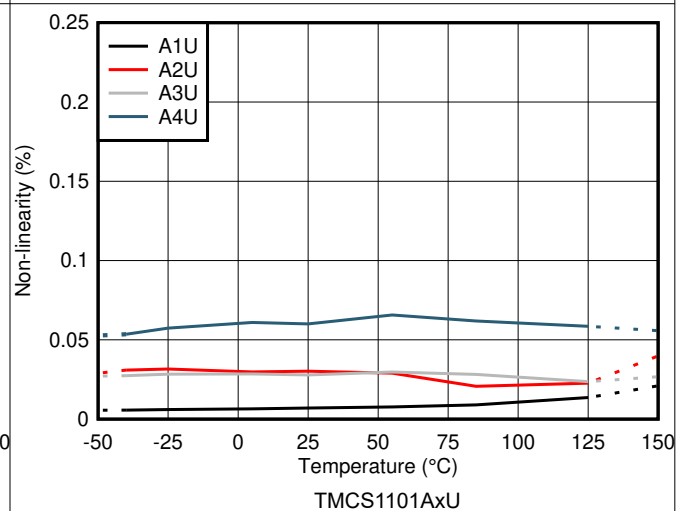

Figure 7-6. Non-Linearity vs. Temperature

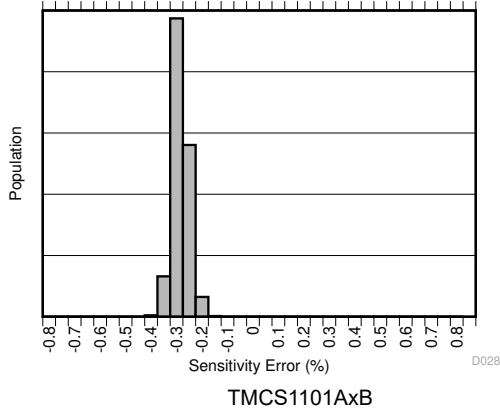

Figure 7-7. Sensitivity Error Production Distribution

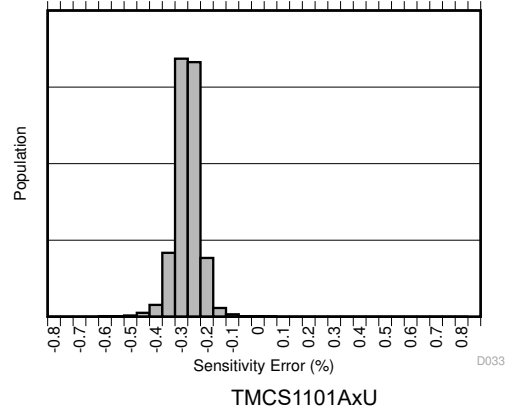

Figure 7-8. Sensitivity Error Production Distribution

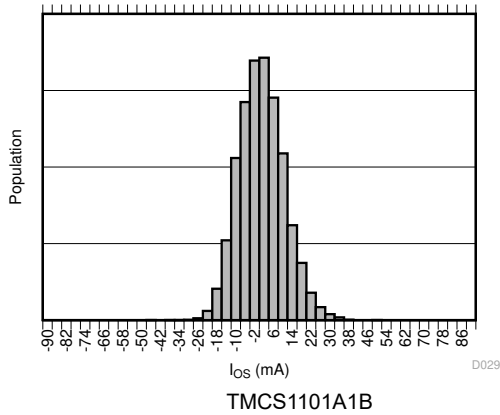

Figure 7-9. Input Offset Current Production Distribution

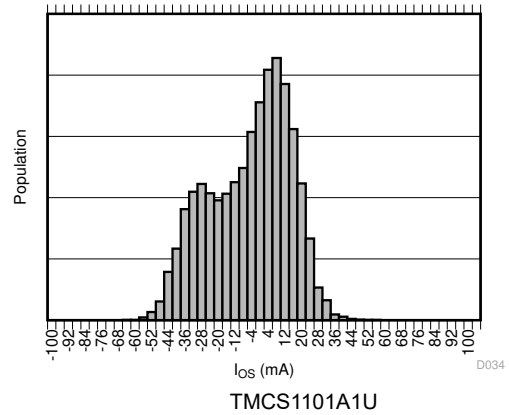

Figure 7-10. Input Offset Current Production Distribution

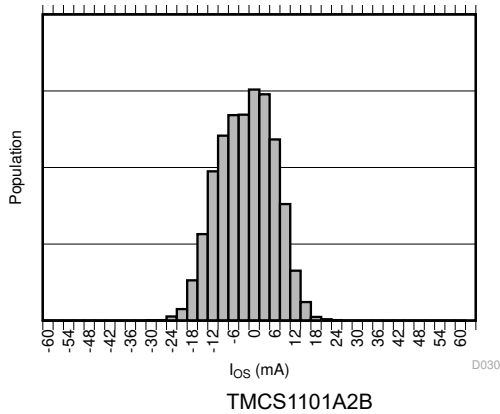

Figure 7-11. Input Offset Current Production Distribution

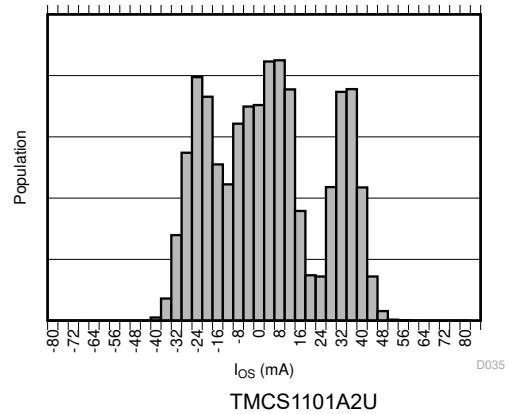

Figure 7-12. Input Offset Current Production Distribution

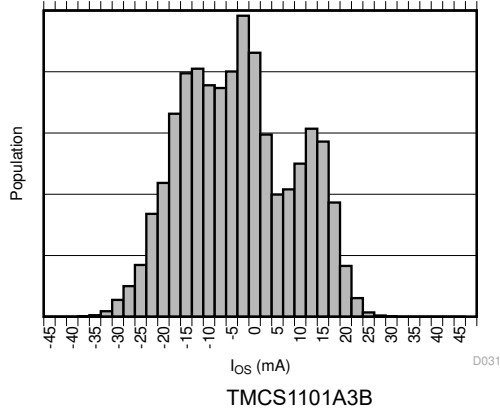

Figure 7-13. Input Offset Current Production Distribution

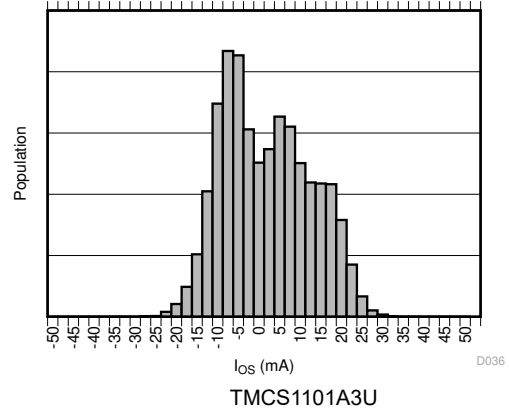

Figure 7-14. Input Offset Current Production Distribution

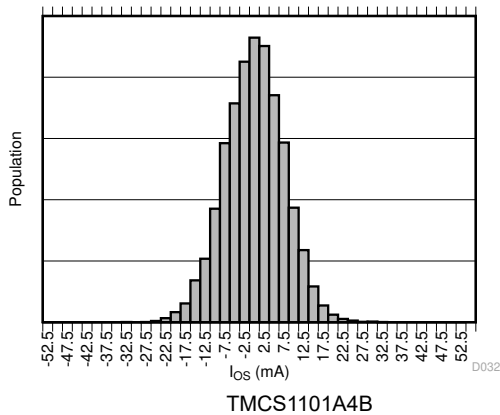

Figure 7-15. Input Offset Current Production Distribution

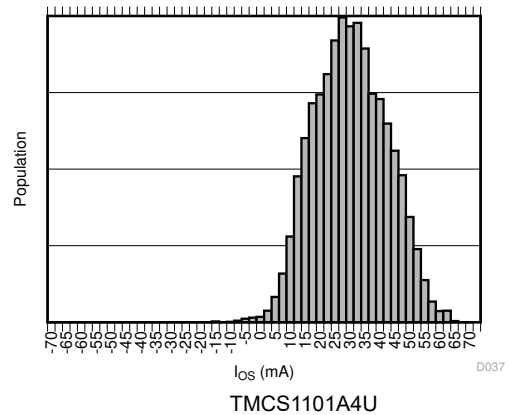

Figure 7-16. Input Offset Current Production Distribution

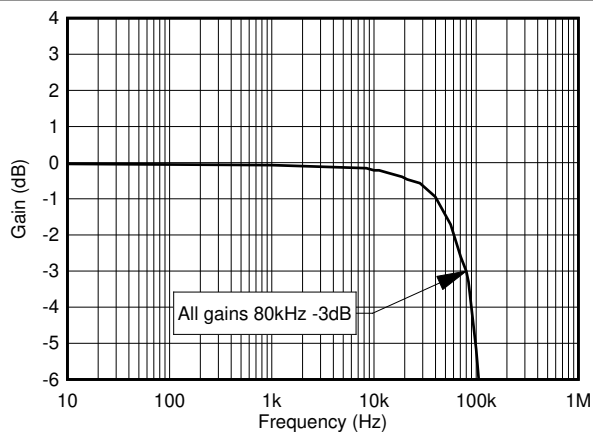

Figure 7-17. Sensitivity vs. Frequency, All Gains Normalized to 1 Hz

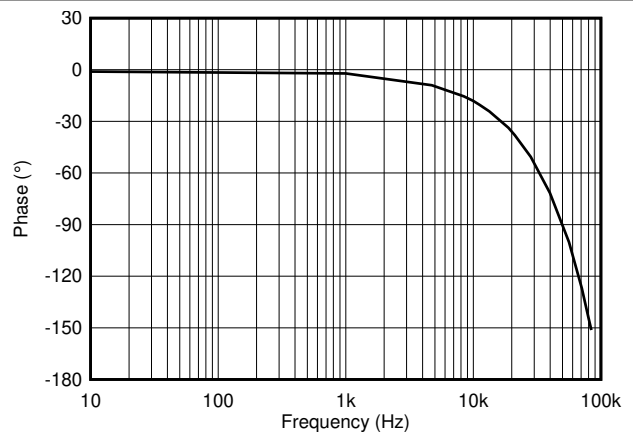

Figure 7-18. Phase vs. Frequency, All Gains

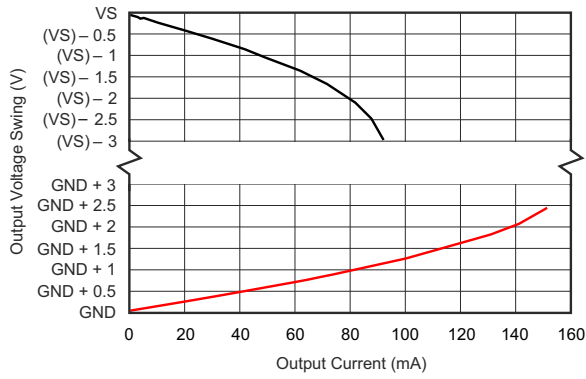

Figure 7-19. Output Swing vs. Output Current

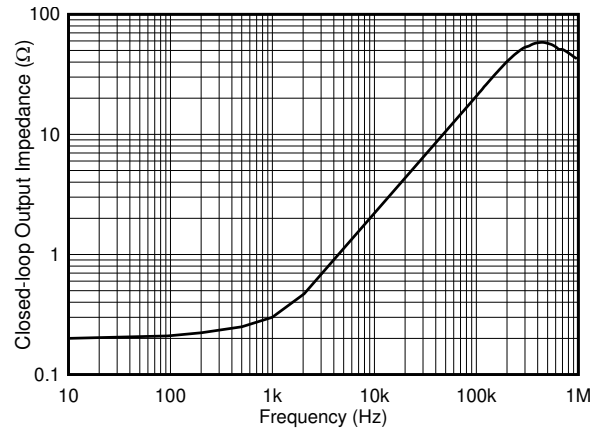

Figure 7-20. Output Impedance vs. Frequency

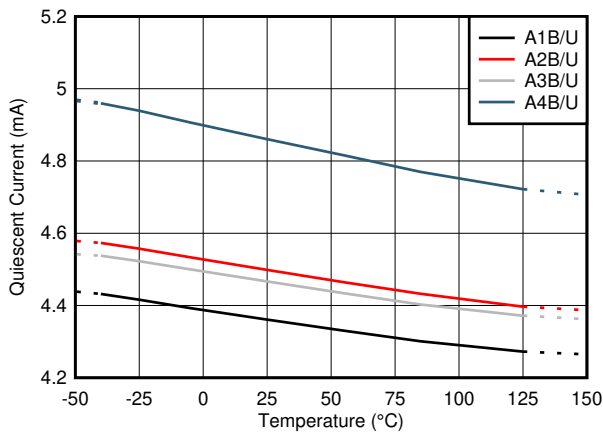

Figure 7-21. Quiescent Current vs. Temperature

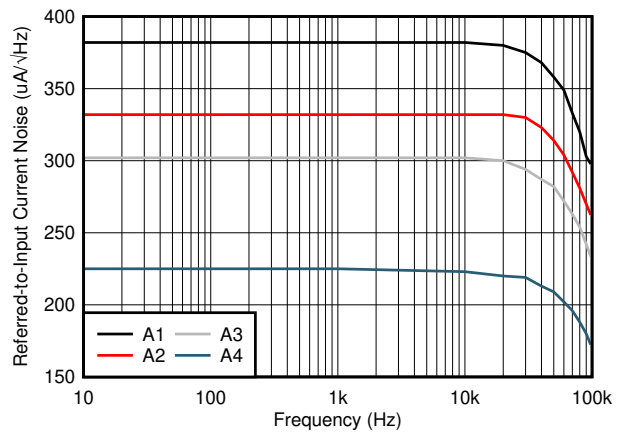

Figure 7-22. Input-Referred Noise vs. Frequency

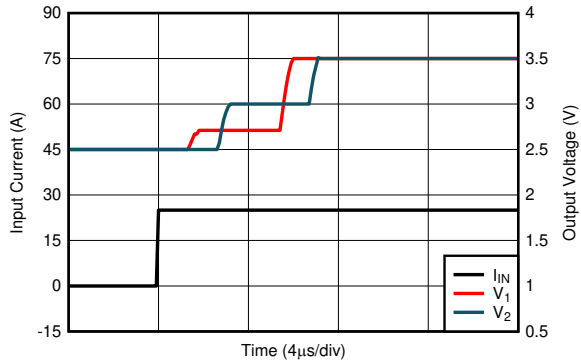

Figure 7-23. Voltage Output Step, Rising

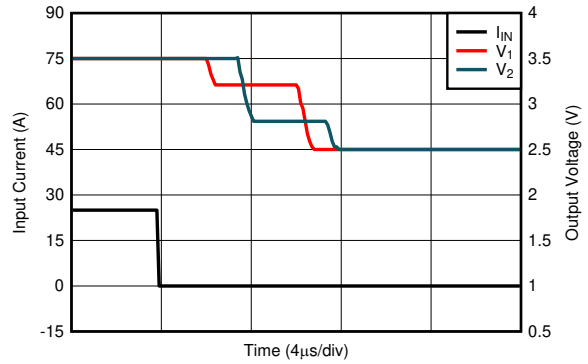
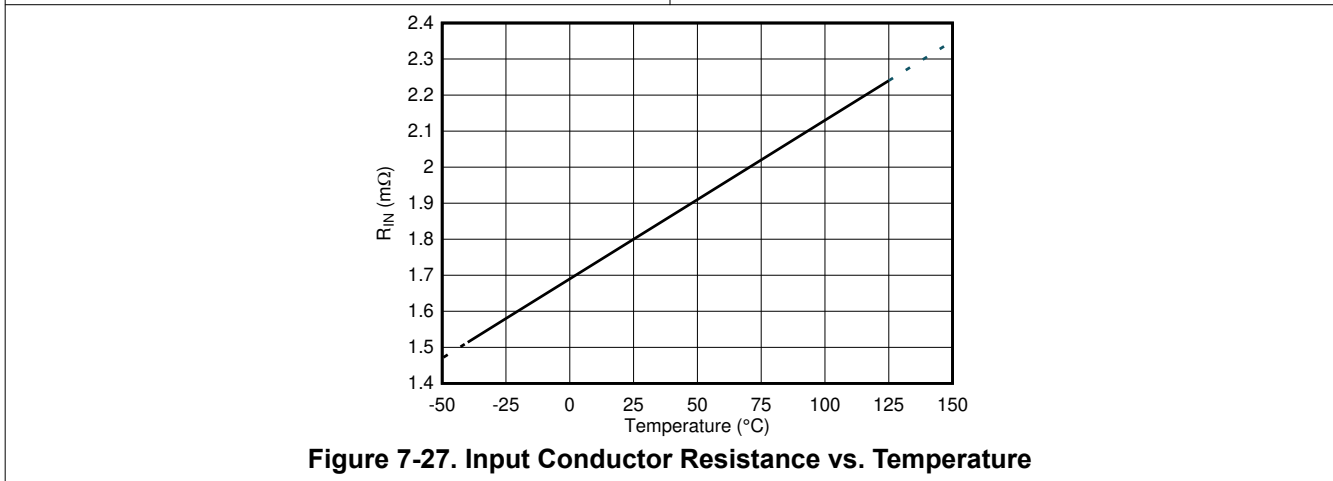
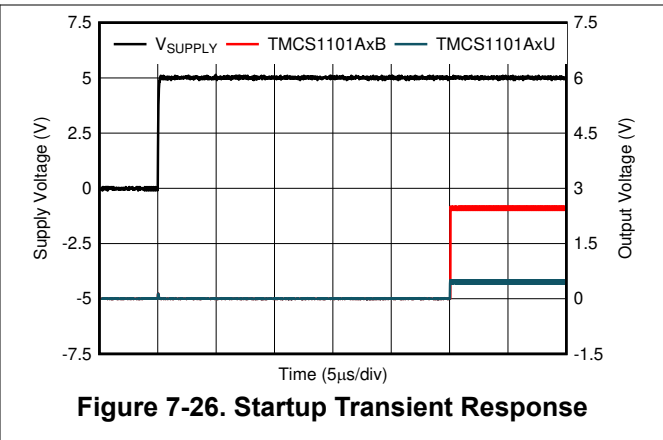
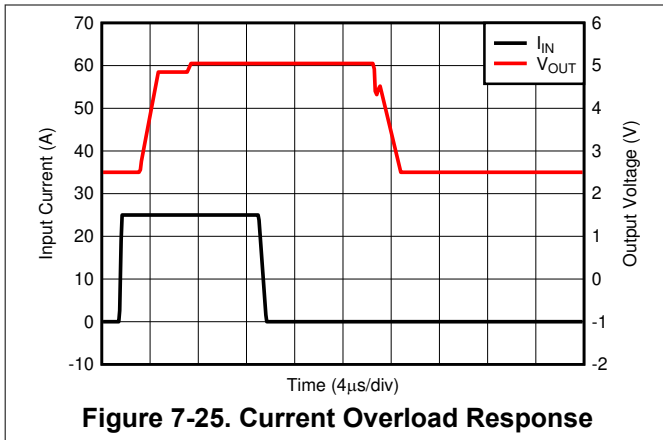
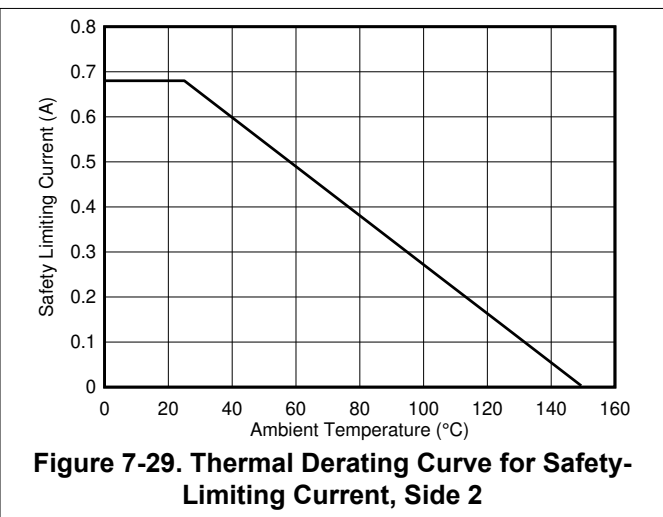
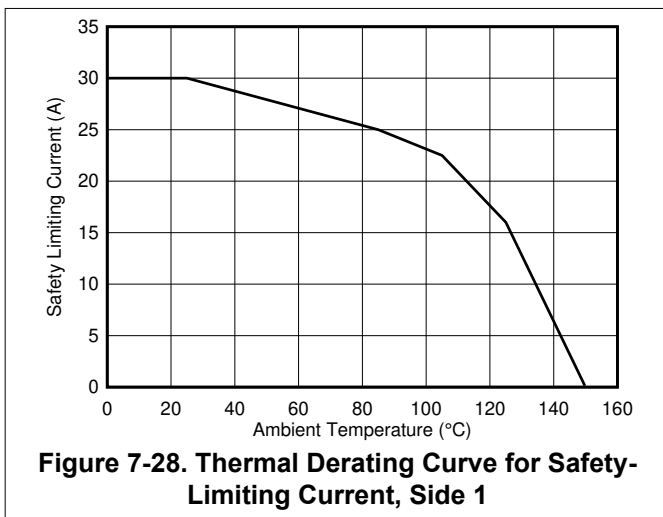

Figure 7-24. Voltage Output Step, Falling



7.10.1 Insulation Characteristics Curves



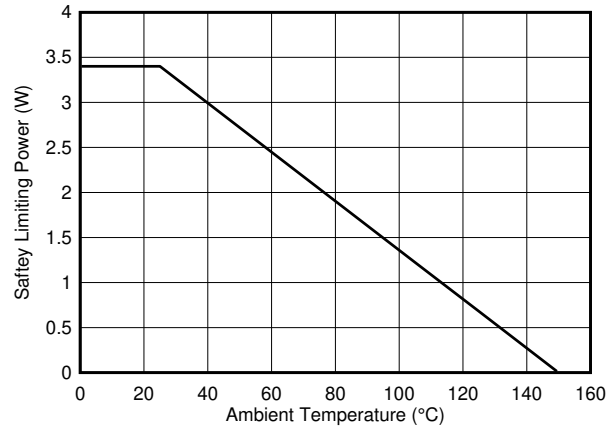

Figure 7-30. Thermal Derating Curve for Safety-Limiting Power

8 Parameter Measurement Information

8.1 Accuracy Parameters

The ideal first-order transfer function of the TMCS1101 is given by Equation 1, where the output voltage is a linear function of input current. The accuracy of the device is quantified both by the error terms in the transfer function parameters, as well as by nonidealities that introduce additional error terms not in the simplified linear model. See [Total Error Calculation Examples](#) for example calculations of total error, including all device error terms.

where

- V_{OUT} is the analog output voltage.
- S is the ideal sensitivity of the device.
- I_{IN} is the isolated input current.
- V_{REF} is the voltage applied to the reference voltage input.

$$V_{OUT} = S \times I_{IN} + V_{OUT,0A} \quad (1)$$

where

- V_{OUT} is the analog output voltage.
- S is the ideal sensitivity of the device.
- I_{IN} is the isolated input current.
- $V_{OUT,0A}$ is the zero current output voltage for the device variant.

8.1.1 Sensitivity Error

Sensitivity is the proportional change in the sensor output voltage due to a change in the input conductor current. This sensitivity is the slope of the first-order transfer function of the sensor, as shown in Figure 8-1. The sensitivity of the TMCS1101 is tested and calibrated at the factory for high accuracy.

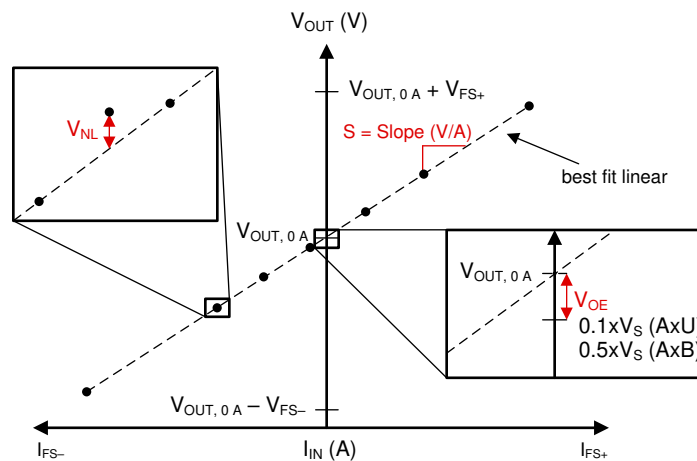

Figure 8-1. Sensitivity, Offset, and Nonlinearity Error

Deviation from ideal sensitivity is quantified by sensitivity error, defined as the percent variation of the best-fit measured sensitivity from the ideal sensitivity. When specified over a temperature range, this is the worst-case sensitivity error at any temperature within the range.

$$e_S = [(S_{\text{fit}} - S_{\text{ideal}}) / S_{\text{ideal}}] \times 100\% \quad (2)$$

where

- e_S is the sensitivity error.
- S_{fit} is the best fit sensitivity.
- S_{ideal} is the ideal sensitivity.

8.1.2 Offset Error and Offset Error Drift

Offset error is the deviation from the ideal output voltage with zero input current through the device. Offset error can be referred to the output as a voltage error V_{OE} or referred to the input as a current offset error I_{OS} . Offset error is a single error source, however, and must only be included once in error calculations.

The output voltage offset error of the TMCS1101 is the deviation of the measured V_{OUT} with zero input current from the ideal value of the zero current output voltage. This ideal voltage is either 10% of V_S for unidirectional devices (AxU) or 50% of V_S for bidirectional devices (AxB), as shown in [Equation 3](#) and [Equation 4](#), respectively.

$$V_{\text{OE}} = V_{\text{OUT},0\text{A}} - V_S * 0.1 \quad (3)$$

$$V_{\text{OE}} = V_{\text{OUT},0\text{A}} - V_S * 0.5 \quad (4)$$

where

- $V_{\text{OUT},0\text{A}}$ is the device output voltage with zero input current.

The offset error includes errors in the internal reference, the magnetic offset of the Hall sensor and any offset voltage errors of the signal chain.

The input referred (RTI) offset error is the output voltage offset error divided by the sensitivity of the device, shown in [Equation 5](#). Refer the offset error to the input of the device to allow for easier total error calculations and direct comparison to input current levels. No matter how the calculations are done, the error sources quantified by V_{OE} and I_{OS} are the same, and should only be included once for error calculations.

$$I_{\text{OS}} = V_{\text{OE}} / S \quad (5)$$

Offset error drift is the change in the input-referred offset error per degree Celsius change in ambient temperature. This parameter is reported in $\mu\text{A}/^\circ\text{C}$. To convert offset drift to an absolute offset for a given change in temperature, multiply the drift by the change in temperature and convert to percentage, as in [Equation 6](#).

$$e_{I_{\text{OS}},\Delta T} (\%) = \frac{I_{\text{OS},25^\circ\text{C}} + I_{\text{OS},\text{drift}} \left(\frac{\mu\text{A}}{^\circ\text{C}} \right) \times \Delta T}{I_{\text{IN}}} \quad (6)$$

where

- $I_{\text{OS},\text{drift}}$ is the specified input-referred device offset drift.
- ΔT is the temperature range from 25°C.

8.1.3 Nonlinearity Error

Nonlinearity is the deviation of the output voltage from a linear relationship to the input current. Nonlinearity voltage, as shown in [Figure 8-1](#), is the maximum voltage deviation from the best-fit line based on measured parameters, calculated by [Equation 7](#).

$$V_{NL} = V_{OUT,MEAS} - (I_{MEAS} \times S_{fit} + V_{OUT,0A}) \quad (7)$$

where

- $V_{OUT,MEAS}$ is the voltage output at maximum deviation from best fit.
- I_{MEAS} is the input current at maximum deviation from best fit.
- S_{fit} is the best-fit sensitivity of the device.
- $V_{OUT,0A}$ is the device zero current output voltage.

Nonlinearity error (e_{NL}) for the TMCS1101 is the nonlinearity voltage specified as a percentage of the full-scale output range (V_{FS}), as shown in [Equation 8](#).

$$e_{NL} = 100\% \times \frac{V_{NL}}{V_{FS}} \quad (8)$$

8.1.4 Power Supply Rejection Ratio

Power supply rejection ratio (PSRR) is the change in device offset due to variation of supply voltage from the nominal 5 V. The error contribution at the input current of interest can be calculated by [Equation 9](#).

$$e_{PSRR}(\%) = \left| \frac{\frac{PSRR * (V_S - 5)}{S}}{I_{IN}} \right| \quad (9)$$

where

- V_S is the operational supply voltage.
- S is the device sensitivity.

8.1.5 Common-Mode Rejection Ratio

Common-mode rejection ratio (CMRR) quantifies the effective input current error due to a varying voltage on the isolated input of the device. Due to magnetic coupling and galvanic isolation of the current signal, the TMCS1101 has very high rejection of input common-mode voltage. Percent error contribution from input common-mode variation can be calculated by [Equation 10](#).

$$e_{CMRR}(\%) = \left| \frac{CMRR * V_{CM}}{I_{IN}} \right| \quad (10)$$

where

- V_{CM} is the maximum operational AC or DC voltage on the input of the device.

8.1.6 External Magnetic Field Errors

The TMCS1101 does not have stray field-rejection capabilities, so external magnetic fields from adjacent high-current traces or nearby magnets can impact the output measurement. The total sensitivity (S) of the device is comprised of the initial transformation of input current to magnetic field quantified as the magnetic coupling factor (G), as well as the sensitivity of the Hall element and the analog circuitry that is factory calibrated to provide a final sensitivity. The output voltage is proportional to the input current by the device sensitivity, as defined in [Equation 11](#).

$$S = G * S_{Hall} * A_V \tag{11}$$

where

- S is the TMCS1101 sensitivity in mV/A.
- G is the magnetic coupling factor in mT/A.
- S_{Hall} is the sensitivity of the Hall plate in mV/mT.
- A_V is the calibrated analog circuitry gain in V/V.

An external field, B_{EXT}, is measured by the Hall sensor and signal chain, in addition to the field generated by the leadframe current, and is added as an extra input term in the total output voltage function:

$$V_{OUT} = B_{EXT} * S_{Hall} * A_V + I_{IN} * G * S_{Hall} * A_V + V_{OUT,0A} \tag{12}$$

Observable from Equation 12 is that the impact of an external field is an additional equivalent input current signal, I_{BEXT}, shown in Equation 13. This effective additional input current has no dependence on Hall or analog circuitry sensitivity, so all gain variants have equivalent input-referred current error due to external magnetic fields.

$$I_{B_{EXT}} = \frac{B_{EXT}}{G} \tag{13}$$

This additional current error generates a percentage error defined by Equation 14.

$$e_{B_{EXT}} (\%) = \frac{\left| \frac{B_{EXT}}{G} \right|}{I_{IN}} \tag{14}$$

8.2 Transient Response Parameters

The transient response of the TMCS1101 is impacted by the 250 kHz sampling rate as defined in [Transient Response](#). Figure 8-2 shows the TMCS1101 response to an input current step sufficient to generate a 1V output change. The typical 4us sampling window can be observed as a periodic step. This sampling window dominates the response of the device, and the response will have some probabilistic nature due to alignment of the input step and the sampling window interval.

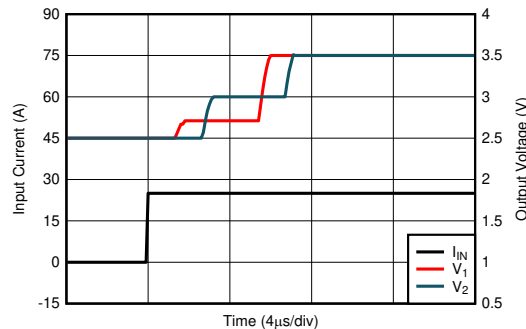

Figure 8-2. Transient Step Response

8.2.1 Slew Rate

Slew rate (SR) is defined as the V_{OUT} rate of change for a single integration step's output transition, as shown in Figure 8-3. Because the device often requires two sampling windows to reach a full 90% settling of its final value, this slew rate is not equal to the 10%-90% transition time for the full output swing.

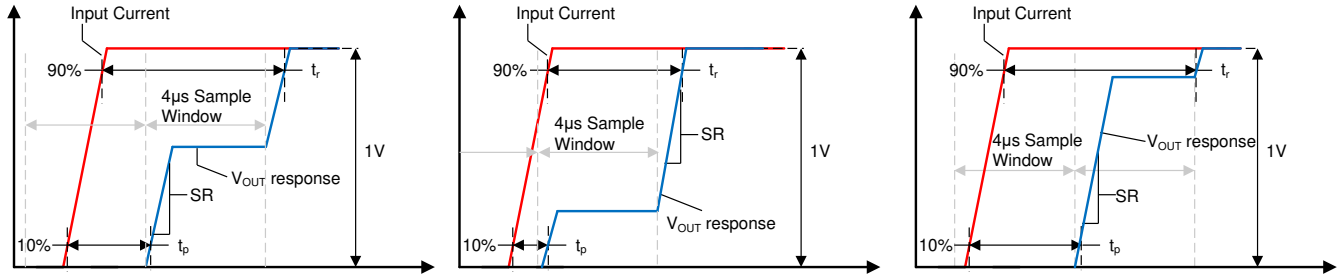

Figure 8-3. Small Current Input Step Transient Response

8.2.2 Propagation Delay and Response Time

Propagation delay is the time period between the input current waveform reaching 10% of its final value and V_{OUT} reaching 10% of its final value. This propagation delay is heavily dependent upon the alignment of the input current step and the sampling period of the TMCS1101, as shown for several different sampling window cases in Figure 8-3.

Response time is the time period between the input current reaching 90% of its final value and the output reaching 90% of its final value, for an input current step sufficient to cause a 1-V transition on the output. Figure 8-3 shows the response time of the TMCS1101 under three different time cases. Unless a step input occurs directly during the beginning of one sampling interval the response time will include two sampling intervals.

8.2.3 Current Overload Parameters

Current overload response parameters are the transient behavior of the TMCS1101 to an input current step consistent with a short circuit or fault event. Tested amplitude is twice the full scale range of the device, or 10V / Sensitivity in V/A. Under these conditions, the TMCS1101 output will respond faster than in the case of a small input current step due to the higher input amplitude signal. Response time and propagation delay are measured in a similar manner to the case of a small input current step, as shown in Figure 8-4.

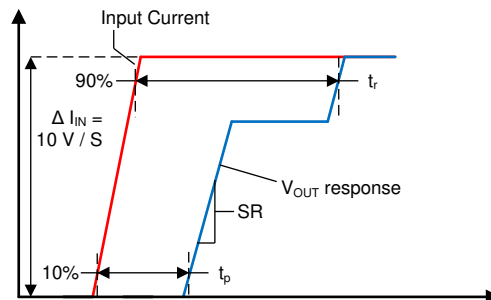

Figure 8-4. Current Overload Transient Response

Current overload recovery time is the required time for the device output to exit a saturated condition and return to normal operation. The transient response of the device during this recovery period from a current overload is shown in Figure 7-25.

8.2.4 CMTI, Common-Mode Transient Immunity

CMTI is the capability of the device to tolerate a rising/falling voltage step on the input without disturbance on the output signal. The device is specified for the maximum common-mode transition rate under which the output signal will not experience a greater than 200-mV disturbance that lasts longer than 1 μ s. Higher edge rates than the specified CMTI can be supported with sufficient filtering or blanking time after common-mode transitions.

8.3 Safe Operating Area

The isolated input current safe operating area (SOA) of the TMCS1101 is constrained by self-heating due to power dissipation in the input conductor. Depending upon the use case, the SOA is constrained by multiple conditions, including exceeding maximum junction temperature, Joule heating in the leadframe, or leadframe fusing under extremely high currents. These mechanisms depend on pulse duration, amplitude, and device thermal states.

Current SOA strongly depends on the thermal environment and design of the system-level board. Multiple thermal variables control the transfer of heat from the device to the surrounding environment, including air flow, ambient temperature, and printed-circuit board (PCB) construction and design. All ratings are for a single TMCS1101 device on the [TMCS1101EVM](#), with no air flow in the specified ambient temperature conditions. Device use profiles must satisfy both continuous conduction and short-duration transient SOA capabilities for the thermal environment under which the system will be operated.

8.3.1 Continuous DC or Sinusoidal AC Current

The longest thermal time constants of device packaging and PCBs are in the order of seconds; therefore, any continuous DC or sinusoidal AC periodic waveform with a frequency higher than 1 Hz can be evaluated based on the RMS continuous-current level. The continuous-current capability has a strong dependence upon the operating ambient temperature range expected in operation. [Figure 8-5](#) shows the maximum continuous current-handling capability of the device on the [TMCS1101EVM](#). Current capability falls off at higher ambient temperatures because of the reduced thermal transfer from junction-to-ambient and increased power dissipation in the leadframe. By improving the thermal design of an application, the SOA can be extended to higher currents at elevated temperatures. Using larger and heavier copper power planes, providing air flow over the board, or adding heat sinking structures to the area of the device can all improve thermal performance.

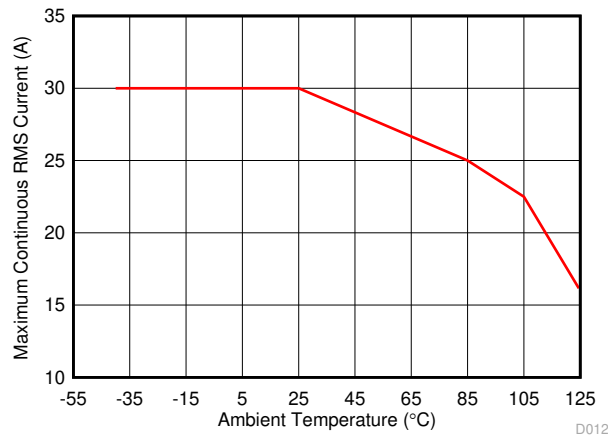

Figure 8-5. Maximum Continuous RMS Current vs. Ambient Temperature

8.3.2 Repetitive Pulsed Current SOA

For applications where current is pulsed between a high current and no current, the allowable capabilities are limited by short-duration heating in the leadframe. The TMCS1101 can tolerate higher current ranges under some conditions, however, for repetitive pulsed events, the current levels must satisfy both the pulsed current SOA and the RMS continuous current constraint. Pulse duration, duty cycle, and ambient temperature all impact the SOA for repetitive pulsed events. Figure 8-6, Figure 8-7, Figure 8-8, and Figure 8-9 illustrate repetitive stress levels based on test results from the TMCS1101EVM under which parametric performance and isolation integrity was not impacted post-stress for multiple ambient temperatures. At high duty cycles or long pulse durations, this limit approaches the continuous current SOA for a RMS value defined by Equation 15.

$$I_{IN,RMS} = I_{IN,P} * \sqrt{D} \tag{15}$$

where

- $I_{IN,RMS}$ is the RMS input current level
- $I_{IN,P}$ is the pulse peak input current
- D is the pulse duty cycle

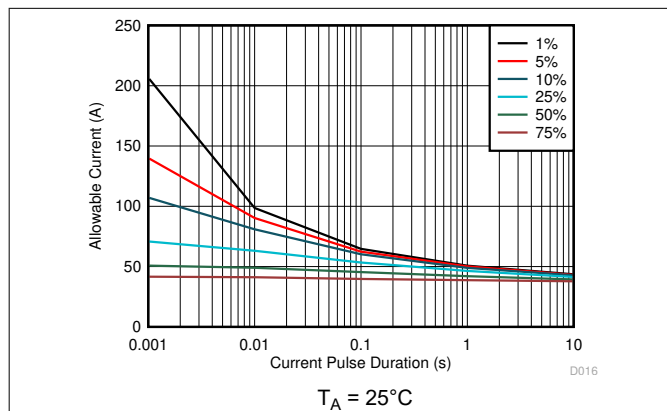

Figure 8-6. Maximum Repetitive Pulsed Current vs. Pulse Duration

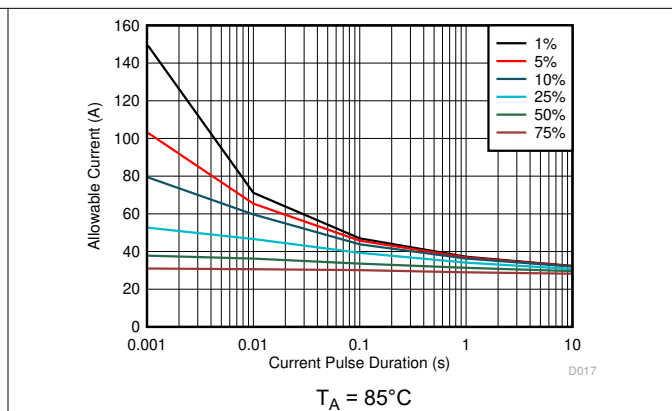

Figure 8-7. Maximum Repetitive Pulsed Current vs. Pulse Duration

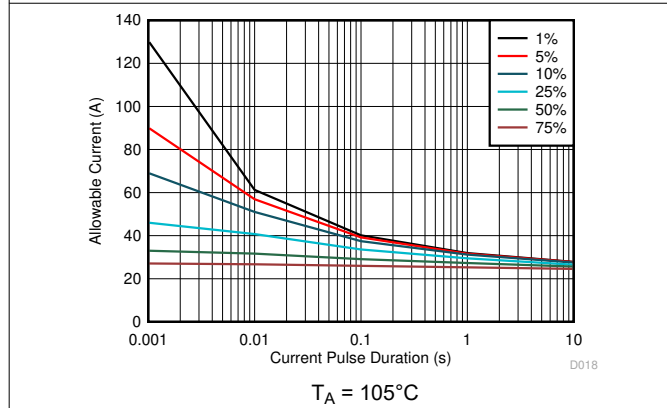

Figure 8-8. Maximum Repetitive Pulsed Current vs. Pulse Duration

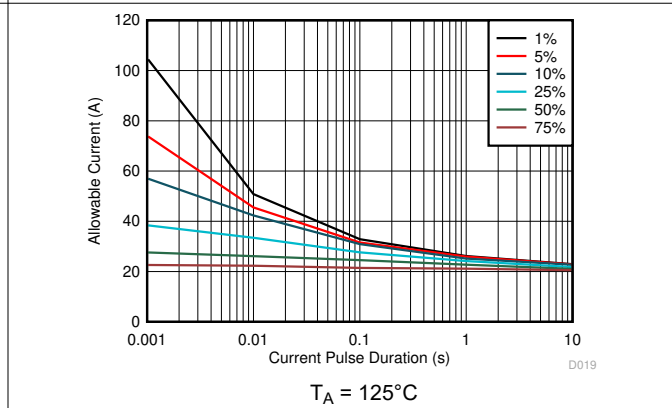

Figure 8-9. Maximum Repetitive Pulsed Current vs. Pulse Duration

8.3.3 Single Event Current Capability

Single higher-current events that are shorter duration can be tolerated by the TMCS1101, because the junction temperature does not reach thermal equilibrium within the pulse duration. [Figure 8-10](#) shows the short-circuit duration curve for the device for single current-pulse events, where the leadframe resistance changes after stress. This level is reached before a leadframe fusing event, but should be considered an upper limit for short duration SOA. For long-duration pulses, the current capability approaches the continuous RMS limit at the given ambient temperature.

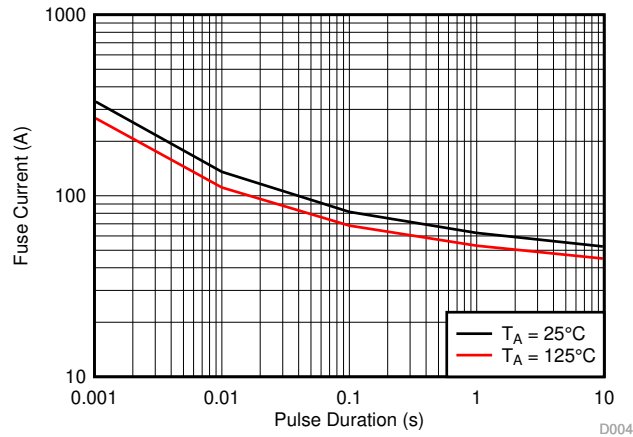

Figure 8-10. Single-Pulse Leadframe Capability

9 Detailed Description

9.1 Overview

The TMCS1101 is a precision Hall-effect current sensor, featuring a 600-V basic isolation working voltage, < 1.5% full-scale error across temperature, and device options providing both unidirectional and bidirectional current sensing. Input current flows through a conductor between the isolated input current pins. The conductor has a 1.8-m Ω resistance at room temperature for low power dissipation and a 20-A RMS continuous current handling capability up to 105°C ambient temperature on the [TMCS1101EVM](#). The low-ohmic leadframe path reduces power dissipation compared to alternative current measurement methodologies, and does not require any external passive components, isolated supplies, or control signals on the high-voltage side. The magnetic field generated by the input current is sensed by a Hall sensor and amplified by a precision signal chain. The device can be used for both AC and DC current measurements and has a bandwidth of 80 kHz. There are multiple fixed-sensitivity device variants for a wide option of linear sensing ranges, and the TMCS1101 can operate with a low voltage supply from 3 V to 5.5 V. The TMCS1101 is optimized for high accuracy and temperature stability, with both offset and sensitivity compensated across the entire operating temperature range.

9.2 Functional Block Diagram

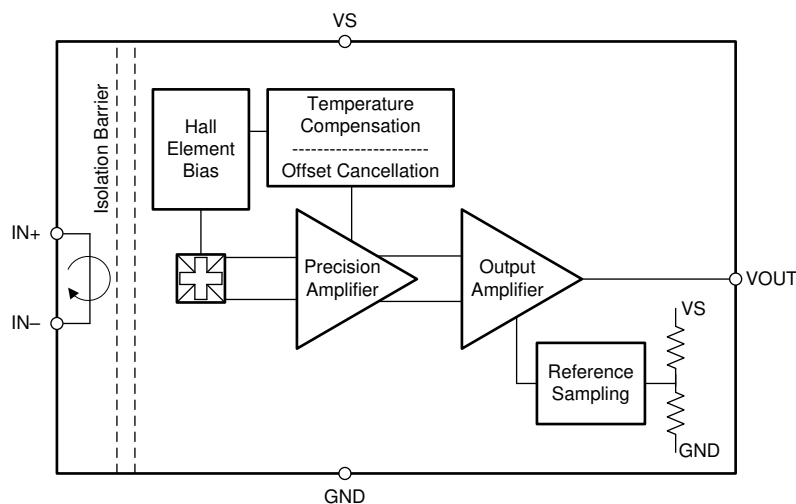

9.3 Feature Description

9.3.1 Current Input

Input current to the TMCS1101 passes through the isolated side of the package leadframe through the IN+ and IN- pins. The current flow through the package generates a magnetic field that is proportional to the input current, and measured by a galvanically isolated, precision, Hall sensor IC. As a result of the electrostatic shielding on the Hall sensor die, only the magnetic field generated by the input current is measured, thus limiting input voltage switching pass-through to the circuitry. This configuration allows for direct measurement of currents with high-voltage transients without signal distortion on the current-sensor output. The leadframe conductor has a nominal resistance of 1.8 m Ω at 25°C, and has a typical positive temperature coefficient as defined in the [Electrical Characteristics](#) table.

9.3.2 Input Isolation

The separation between the input conductor and the Hall sensor die due to the TMCS1101 construction provides inherent galvanic isolation between package pins 1-4 and pins 5-8. Insulation capability is defined according to certification agency definitions and using industry-standard test methods as defined in the [Insulation Specifications](#) table. Assessment of device lifetime working voltages follow the VDE 0884-11 standard for basic insulation, requiring time-dependent dielectric breakdown (TDDB) data-projection failure rates of less than 1000 part per million (ppm), and a minimum insulation lifetime of 20 years. The VDE standard also requires an additional safety margin of 20% for working voltage, and a 30% margin for insulation lifetime, translating into a minimum required lifetime of 26 years at 509 V_{RMS} for the TMCS1101.

Figure 9-1 shows the intrinsic capability of the isolation barrier to withstand high-voltage stress over the lifetime of the device. Based on the TDDB data, the intrinsic capability of these devices is 424 V_{RMS} with a lifetime of > 100 years. Other factors such as operating environment and pollution degree can further limit the working voltage of the component in an end system.

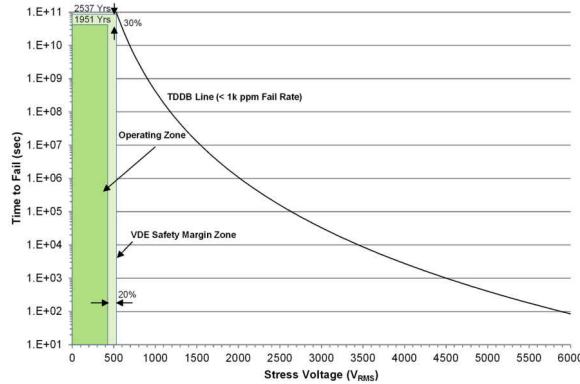

Figure 9-1. Insulation Lifetime

9.3.3 High-Precision Signal Chain

The TMCS1101 uses a precision, low-drift signal chain with proprietary sensor linearization techniques to provide a highly accurate and stable current measurement across the full temperature range of the device. The device is fully tested and calibrated at the factory to account for any variations in either silicon or packaging process variations. The full signal chain provides a fixed sensitivity voltage output that is proportional to the current through the leadframe of the isolated input.

9.3.3.1 Temperature Stability

The TMCS1101 includes a proprietary temperature compensation technique which results in significantly improved parametric drift across the full temperature range. This compensation technique accounts for changes in ambient temperature, self-heating, and package stress. A zero-drift signal chain architecture and Hall sensor temperature stabilization methods enable stable sensitivity and minimize offset errors across temperature, and drastically improves system-level performance across the required operating conditions.

Figure 9-2 and Figure 9-3 show the offset error across the full device ambient temperature range. Figure 9-4 and Figure 9-5 show the typical sensitivity. There are no other external components introducing errors sources; therefore, the high intrinsic accuracy and stability over temperature directly translates to system-level performance. As a result of this high precision, even a system with no calibration can reach < 1.5% of total error current-sensing capability.

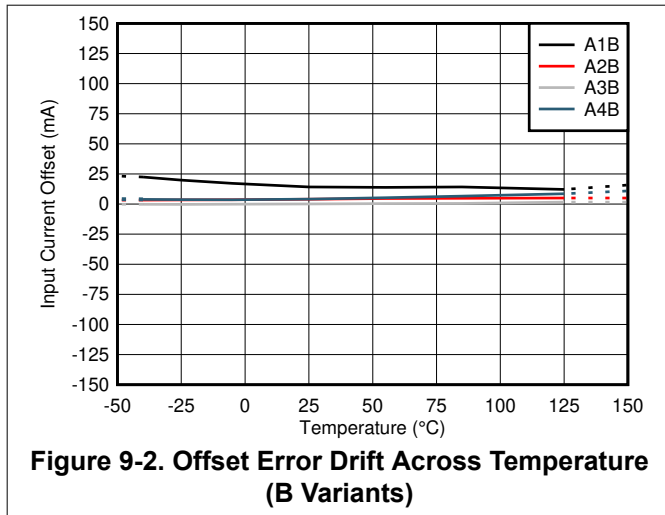

Figure 9-2. Offset Error Drift Across Temperature (B Variants)

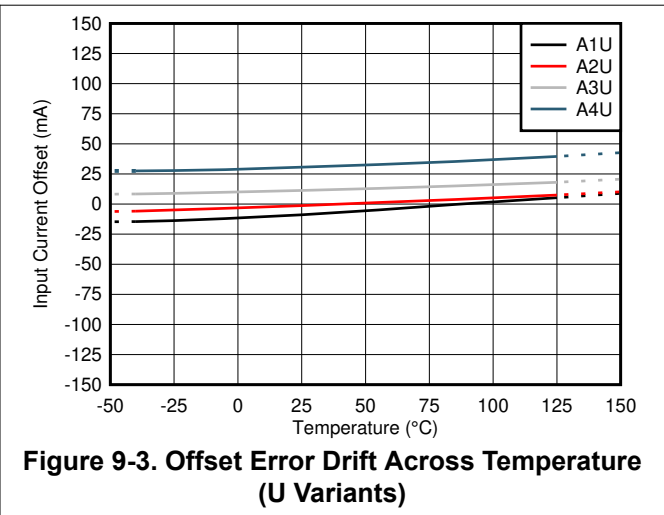
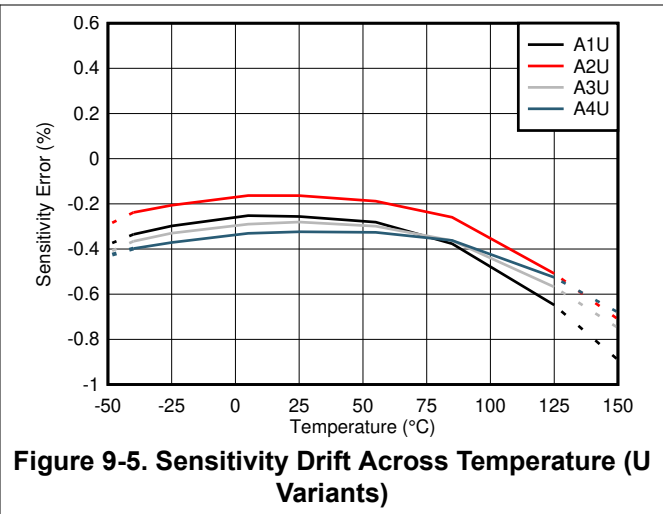
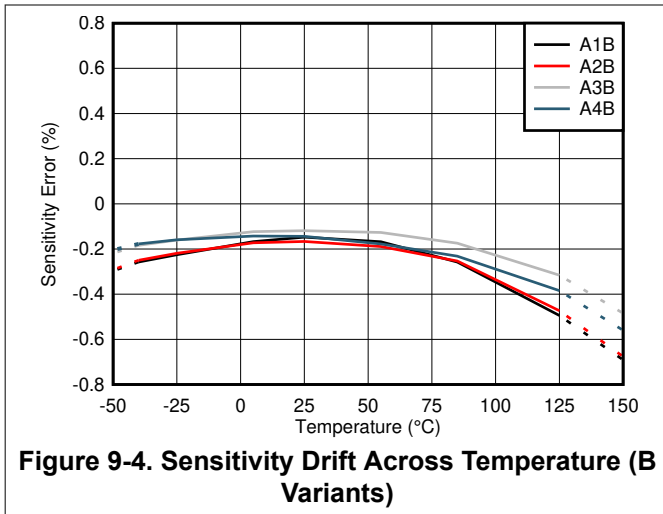
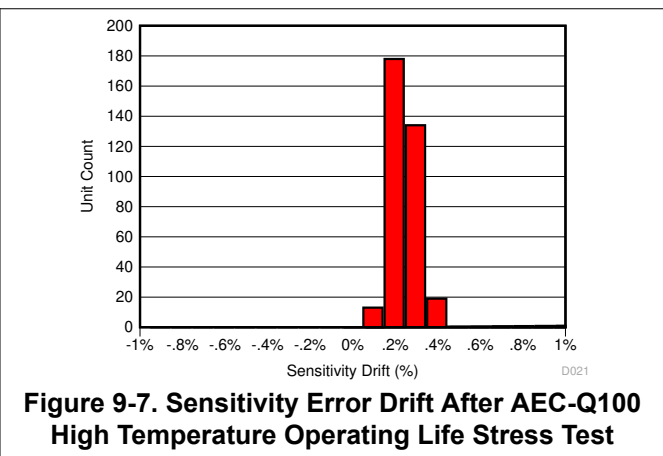
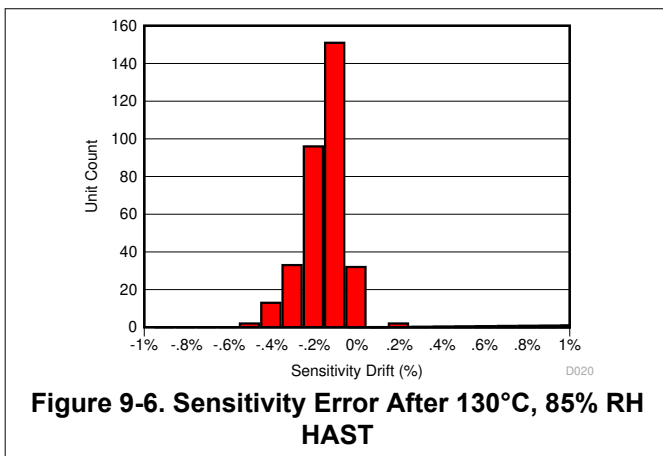

Figure 9-3. Offset Error Drift Across Temperature (U Variants)



9.3.3.2 Lifetime and Environmental Stability

The same compensation techniques used in the TMCS1101 to reduce temperature drift also greatly reduce lifetime drift due to aging, stress, and environmental conditions. Typical magnetic sensors suffer from up to 2% to 3% of sensitivity drift due to aging at high operating temperatures. The TMCS1101 has greatly improved lifetime drift, as defined in the [Electrical Characteristics](#) for total sensitivity error measured after the worst case stress test during a three lot AEC-Q100 qualification. All other stress tests prescribed by an AEC-Q100 qualification caused lower than the specified sensitivity error, and were within the bounds specified within the [Electrical Characteristics](#) table. [Figure 9-6](#) shows the total sensitivity error after the worst-case stress test, a Highly Accelerated Stress Test (HAST) at 130°C and 85% relative humidity (RH), while [Figure 9-7](#) and [Figure 9-8](#) show the sensitivity and offset error drift after a 1000 hour, 125°C high temperature operating life stress test as specified by AEC-Q100. This test mimics typical device lifetime operation, and shows the likely device performance variation due to aging is vastly improved compared to typical magnetic sensors.



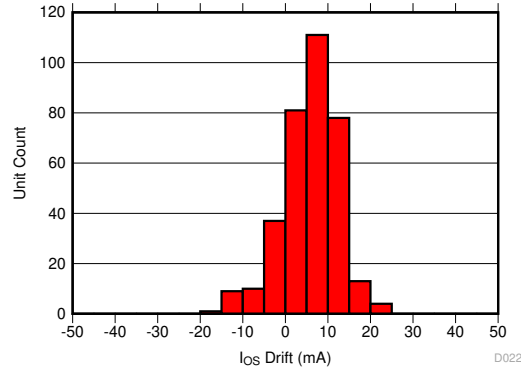

Figure 9-8. Input-Referred Offset Drift After AEC-Q100 High Temperature Operating Life Stress Test

9.3.3.3 Frequency Response

The TMCS1101 signal chain has a spectral response atypical of a linear analog system due to its discrete time sampling. The 250-kHz sampling interval implies an effective Nyquist frequency of 125 kHz, which limits spectral response to below this frequency. Higher frequency content than this frequency will be aliased down to lower spectrums.

The TMCS1101 bandwidth is defined by the -3 -dB spectral response of the entire signal chain which is constrained by the sampling frequency. Normalized gain and phase plots across frequency are shown below in [Figure 9-9](#) and [Figure 9-10](#), all variants have the same bandwidth and phase response. Signal content beyond the 3-dB bandwidth level will still have significant fundamental frequency transmission through the signal chain, but at increasing distortion levels

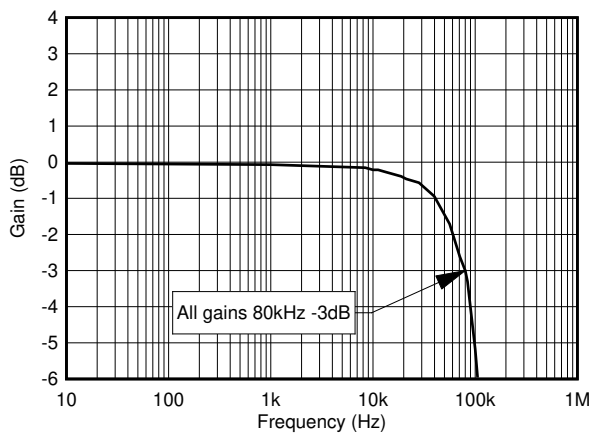

Figure 9-9. Normalized Gain, All Variants

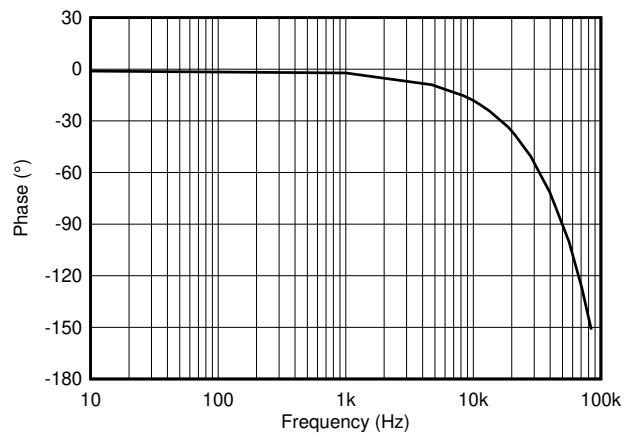

Figure 9-10. Normalized Phase, All Variants

9.3.3.4 Transient Response

The TMCS1101 signal chain includes a precision analog front end followed by a sampled integrator. At the end of each integration cycle, the signal propagates to the output. Depending on the alignment of a change in input current relative to the sampling window, the output might not settle to the final signal until the second integration cycle. [Figure 9-11](#) shows a typical output waveform response to a 10-kHz sine wave input current. For a slowly varying input current signal, the output is a discrete time representation with a phase delay of the integration sampling window. Adding a first order filter of 100 kHz effectively smooths the output waveform with minimal impact to phase response.

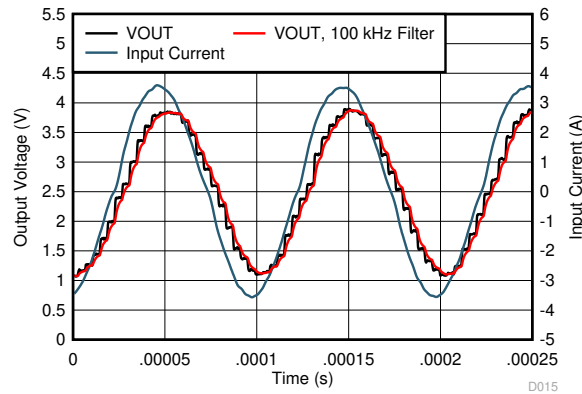

Figure 9-11. Response Behavior to 10-kHz Sine Wave Input Current

Figure 9-12 shows two transient waveforms to an input-current step event, but occurring at different times during the sampling interval. In both cases, the full transition of the output takes two sampling intervals to reach the final output value. The timing of the current event relative to the sampling window determines the proportional amplitude of the first and second sampling intervals.

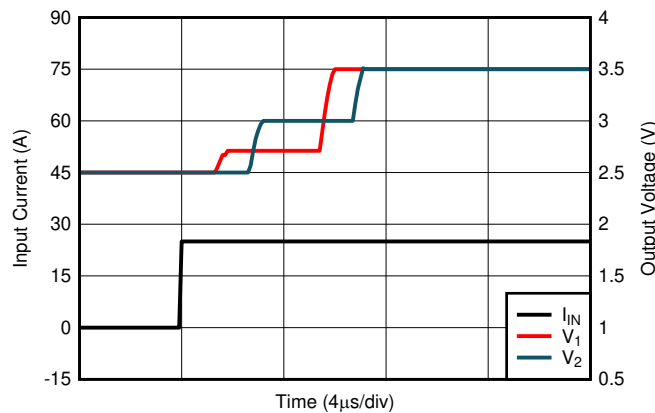

Figure 9-12. Transient Response to Input-Current Step Sufficient for 1-V Output Swing

The output value is effectively an average over the sampling window; therefore, a large-enough current transient can drive the output voltage to near the full scale range in the first sample response. This condition is likely to be true in the case of a short-circuit or fault event. Figure 9-13 shows an input-current step twice the full scale measurable range with two output voltage responses illustrating the effect of the sampling window. The relative timing and size of the input current transition determines both the time and amplitude of the first output transition. In either case, the total response time is slightly longer than one integration period.

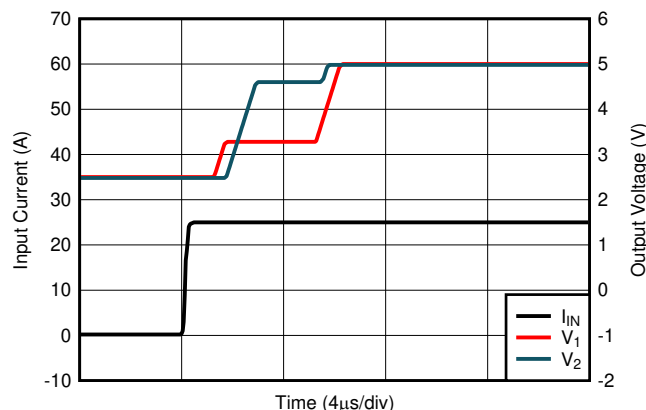

Figure 9-13. Transient Response to a Large Input Current Step

9.3.4 Internal Reference Voltage

The device has an internal resistor divider from the analog supply V_S that determines the zero-current output voltage, $V_{OUT,0A}$. This zero-current output level along with sensitivity determine the measurable input current range of the device, and allows for unidirectional or bidirectional sensing, as described in the [Absolute Maximum Ratings](#) table. The TMCS1101AxB variants have a zero-current output set by [Equation 16](#), while the TMCS1101AxU devices have a zero-current output voltage set by [Equation 17](#).

$$V_{OUT,0A} = V_S \times 0.5 \quad (16)$$

$$V_{OUT,0A} = V_S \times 0.1 \quad (17)$$

These respective reference voltages enable a bidirectional measurable current range for the TMCS1101A2B devices and a unidirectional measurement range for the TMCS1101A2U devices, as shown in [Figure 9-14](#).

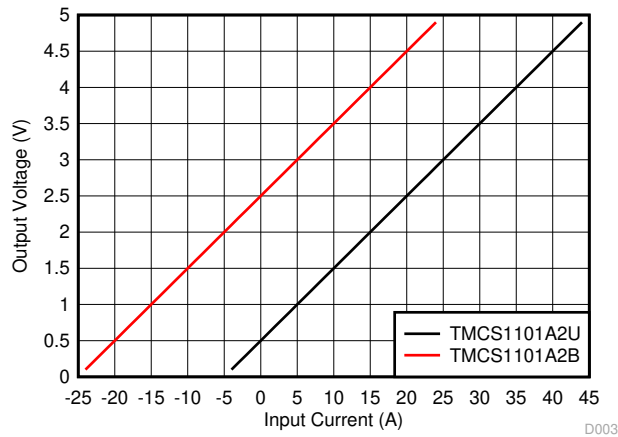

Figure 9-14. Output Voltage Relationship to Input Current for TMCS1101A2B and TMCS1101A2U

9.3.5 Current-Sensing Measurable Ranges

The TMCS1101 measurable input current range depends on the device variant, as well as the analog supply V_S . The output voltage is limited by V_{OUT} swing to either supply or ground. The linear output swing range to both V_S and GND is calculated by equations [Equation 18](#) and [Equation 19](#).

$$V_{OUT,max} = V_S - \text{Swing}_{V_S} \quad (18)$$

$$V_{OUT,min} = \text{Swing}_{GND} \quad (19)$$

Rearranging the transfer function of the device to solve for input current and substituting $V_{OUT,max}$ and $V_{OUT,min}$ yields maximum and minimum measurable input current ranges described by [Equation 20](#) and [Equation 21](#).

$$I_{IN,MAX+} = (V_{OUT,max} - V_{OUT,0A}) / S \quad (20)$$

$$I_{IN,MAX-} = (V_{OUT,0A} - V_{OUT,min}) / S \quad (21)$$

where

- $I_{IN,MAX+}$ is the maximum linear measurable positive input current.
- $I_{IN,MAX-}$ is the maximum linear measurable negative input current.
- S is the sensitivity of the device variant.
- $V_{OUT,0A}$ is the appropriate zero current output voltage.

TMCS1101AxB variants accommodate bidirectional current sensing by creating zero-current output voltage equal to half of the supply (V_S) potential, while TMCS1101AxU variants provide most of the measurable range for positive currents.

9.4 Device Functional Modes

9.4.1 Power-Down Behavior

As a result of the inherent galvanic isolation of the device, very little consideration must be paid to powering down the device, as long as the limits in the [Absolute Maximum Ratings](#) table are not exceeded on any pins. The isolated current input and the low-voltage signal chain can be decoupled in operational behavior, as either can be energized with the other shut down, as long as the isolation barrier capabilities are not exceeded. The low-voltage power supply can be powered down while the isolated input is still connected to an active high-voltage signal or system.

10 Application and Implementation

Note

Information in the following applications sections is not part of the TI component specification, and TI does not warrant its accuracy or completeness. TI's customers are responsible for determining suitability of components for their purposes, as well as validating and testing their design implementation to confirm system functionality.

10.1 Application Information

The key feature sets of the TMCS1101 provide significant advantages in any application where an isolated current measurement is required.

- Galvanic isolation provides a high isolated working voltage and excellent immunity to input voltage transients.
- Hall based measurement simplifies system level solution without the need for a power supply on the high voltage (HV) side.
- An input current path through the low impedance conductor minimizes power dissipation.
- Excellent accuracy and low temperature drift eliminate the need for multipoint calibrations without sacrificing system performance.
- A wide operating supply range enables a single device to function across a wide range of voltage levels.

These advantages increase system-level performance while minimizing complexity for any application where precision current measurements must be made on isolated currents. Specific examples and design requirements are detailed in the following section.

10.1.1 Total Error Calculation Examples

Total error can be calculated for any arbitrary device condition and current level. Error sources considered should include input-referred offset current, power-supply rejection, input common-mode rejection, sensitivity error, nonlinearity, and the error caused by any external fields. Compare each of these error sources in percentage terms, as some are significant drivers of error and some have inconsequential impact to current error. Offset (Equation 22), CMRR (Equation 24), PSRR (Equation 23), and external field error (Equation 25) are all referred to the input, and so, are divided by the actual input current I_{IN} to calculate percentage errors. For calculations of sensitivity error and nonlinearity error, the percentage limits explicitly specified in the [Electrical Characteristics](#) table can be used.

$$e_{I_{OS}} (\%) = \frac{I_{OS}}{I_{IN}} \tag{22}$$

$$e_{PSRR} (\%) = \left| \frac{PSRR * (V_S - 5)}{S} \right| \frac{1}{I_{IN}} \tag{23}$$

$$e_{CMRR} (\%) = \left| \frac{CMRR * V_{CM}}{I_{IN}} \right| \tag{24}$$

$$e_{B_{EXT}} (\%) = \frac{\left| \frac{B_{EXT}}{G} \right|}{I_{IN}} \tag{25}$$

When calculating error contributions across temperature, only the input offset current and sensitivity error contributions vary significantly. For determining offset error over a given temperature range (ΔT), use Equation 26 to calculate total offset error current. Sensitivity error is specified for both -40°C to 85°C and -40°C to 125°C . The appropriate specification should be used based on application operating ambient temperature range.

$$e_{I_{OS},\Delta T}(\%) = \frac{I_{OS,25^\circ C} + I_{OS,drift} \left(\frac{\mu A}{^\circ C} \right) \times \Delta T}{I_{IN}} \tag{26}$$

To accurately calculate the total expected error of the device, the contributions from each of the individual components above must be understood in reference to operating conditions. To account for the individual error sources that are statistically uncorrelated, a root sum square (RSS) error calculation should be used to calculate total error. For the TMCS1101, only the input referred offset current (I_{OS}), CMRR, and PSRR are statistically correlated. These error terms are lumped in an RSS calculation to reflect this nature, as shown in Equation 27 for room temperature and Equation 28 for across a given temperature range. The same methodology can be applied for calculating typical total error by using the appropriate error term specification.

$$e_{RSS}(\%) = \sqrt{(e_{I_{OS}} + e_{PSRR} + e_{CMRR})^2 + e_{B_{EXT}}^2 + e_S^2 + e_{NL}^2} \tag{27}$$

$$e_{RSS,\Delta T}(\%) = \sqrt{(e_{I_{OS},\Delta T} + e_{PSRR} + e_{CMRR})^2 + e_{B_{EXT}}^2 + e_{S,\Delta T}^2 + e_{NL}^2} \tag{28}$$

The total error calculation has a strong dependence on the actual input current; therefore, always calculate total error across the dynamic range that is required. These curves asymptotically approach the sensitivity and nonlinearity error at high current levels, and approach infinity at low current levels due to offset error terms with input current in the denominator. Key figures of merit for any current-measurement system include the total error percentage at full-scale current, as well as the dynamic range of input current over which the error remains below some key level. Figure 10-1 illustrates the RSS maximum total error as a function of input current for a TMCS1101A2B at room temperature and across the full temperature range with V_S of 5 V.

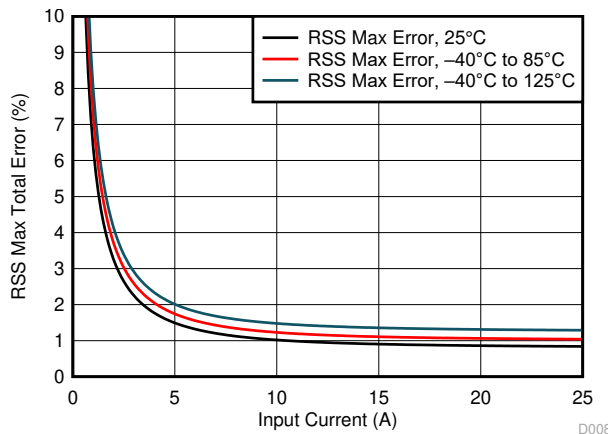

Figure 10-1. RSS Error vs. Input Current

10.1.1.1 Room Temperature Error Calculations

For room-temperature total-error calculations, specifications across temperature and drift are ignored. As an example, consider a TMCS1101 A1B with a supply voltage (V_S) of 3.3 V and a worst-case common-mode excursion of 600 V to calculate operating-point-specific parameters. Consider a measurement error due to an external magnetic field of 30 μT , roughly the Earth's magnetic field strength. The full-scale current range of the device in specified conditions is slightly greater than 33 A; therefore, calculate error at both 25 A and 12.5 A to highlight error dependence on the input-current level. Table 10-1 shows the individual error components and RSS maximum total error calculations at room temperature under the conditions specified. Relative to other errors, the additional error from CMRR is negligible, and can typically be ignored for total error calculations.

Table 10-1. Total Error Calculation: Room Temperature Example

ERROR COMPONENT	SYMBOL	EQUATION	% TOTAL ERROR AT $I_{IN} = 25\text{ A}$	% TOTAL ERROR AT $I_{IN} = 12.5\text{ A}$
Input offset error	$e_{I_{OS}}$	$e_{I_{OS}}(\%) = \frac{I_{OS}}{I_{IN}}$	0.36%	0.72%
PSRR error	e_{PSRR}	$e_{PSRR}(\%) = \left \frac{PSRR * (V_S - 5)}{S} \right \frac{1}{I_{IN}}$	0.41%	0.82%
CMRR error	e_{CMRR}	$e_{CMRR}(\%) = \left \frac{CMRR * V_{CM}}{I_{IN}} \right $	0.01%	0.02%
External Field error	$e_{B_{EXT}}$	$e_{B_{EXT}}(\%) = \frac{\left \frac{B_{EXT}}{G} \right }{I_{IN}}$	0.11%	0.22%
Sensitivity error	e_S	Specified in Electrical Characteristics	0.8%	0.8%
Nonlinearity error	e_{NL}	Specified in Electrical Characteristics	0.05%	0.05%
RSS total error	e_{RSS}	$e_{RSS}(\%) = \sqrt{(e_{I_{OS}} + e_{PSRR} + e_{CMRR})^2 + e_{B_{EXT}}^2 + e_S^2 + e_{NL}^2}$	1.12%	1.77%

10.1.1.2 Full Temperature Range Error Calculations

To calculate total error across any specific temperature range, [Equation 27](#) and [Equation 28](#) should be used for RSS maximum total errors, similar to the example for room temperatures. Conditions from the example in [Room Temperature Error Calculations](#) have been replaced with their respective equations and error components for a -40°C to 85°C temperature range below in [Table 10-2](#).

Table 10-2. Total Error Calculation: -40°C to 85°C Example

ERROR COMPONENT	SYMBOL	EQUATION	% MAX TOTAL ERROR AT $I_{IN} = 25\text{ A}$	% MAX TOTAL ERROR AT $I_{IN} = 12.5\text{ A}$
Input offset error	$e_{I_{OS,\Delta T}}$	$e_{I_{OS,\Delta T}}(\%) = \frac{I_{OS,25^\circ\text{C}} + I_{OS,drift} \left(\frac{\mu\text{A}}{^\circ\text{C}} \right) \times \Delta T}{I_{IN}}$	0.4%	0.81%
PSRR error	e_{PSRR}	$e_{PSRR}(\%) = \left \frac{PSRR * (V_S - 5)}{S} \right \frac{1}{I_{IN}}$	0.41%	0.82%
CMRR error	e_{CMRR}	$e_{CMRR}(\%) = \left \frac{CMRR * V_{CM}}{I_{IN}} \right $	0.01%	0.02%
External Field error	$e_{B_{EXT}}$	$e_{B_{EXT}}(\%) = \frac{\left \frac{B_{EXT}}{G} \right }{I_{IN}}$	0.11%	0.22%
Sensitivity error	$e_{S,\Delta T}$	Specified in Electrical Characteristics	1%	1%
Nonlinearity error	e_{NL}	Specified in Electrical Characteristics	0.05%	0.05%
RSS total error	$e_{RSS,\Delta T}$	$e_{RSS,\Delta T}(\%) = \sqrt{(e_{I_{OS,\Delta T}} + e_{PSRR} + e_{CMRR})^2 + e_{B_{EXT}}^2 + e_{S,\Delta T}^2 + e_{NL}^2}$	1.3%	1.94%

10.2 Typical Application

Inline sensing of inductive load currents, such as motor phases, provides significant benefits to the performance of a control systems, allowing advanced control algorithms and diagnostics with minimal postprocessing. A primary challenge to inline sensing is that the current sensor is subjected to full HV supply-level PWM transients driving the load. The inherent isolation of an in-package Hall-effect current sensor topology helps overcome this challenge, providing high common-mode immunity, as well as isolation between the high-voltage motor drive levels and the low-voltage control circuitry. [Figure 10-2](#) illustrates the use of the TMCS1101 in such an application, driving the inductive load presented by a three phase motor.

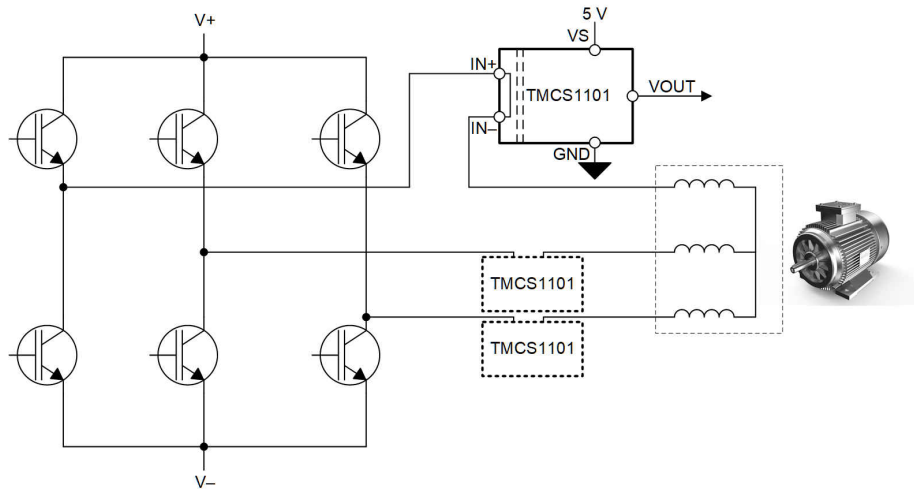

Figure 10-2. Inline Motor Phase Current Sensing

10.2.1 Design Requirements

For current sensing of a three-phase motor application, make sure to provide linear sensing across the expected current range, and make sure that the device remains within working thermal constraints. A single TMCS1101 for each phase can be used, or two phases can be measured, and the third phase calculated on the motor-controller host processor. For this example, consider a nominal supply of 5 V but a minimum of 4.9 V to include for some supply variation. Maximum output swings are defined according to TMCS1101 specifications, and a full-scale current measurement of ± 20 A is required.

Table 10-3. Example Application Design Requirements

DESIGN PARAMETER	EXAMPLE VALUE
$V_{S,nom}$	5 V
$V_{S,min}$	4.9 V
$I_{IN,FS}$	± 20 A

10.2.2 Detailed Design Procedure

The primary design parameter for using the TMCS1101 is selecting the correct sensitivity variant, and because positive and negative current must be measured a bidirectional variant should be selected (A1B-A4B). Further consideration of noise and integration with an ADC can be explored, but is beyond the scope of this application design example. The TMCS1101AxB transfer function is effectively a transimpedance with a variable offset set by $V_{OUT,0A}$, which is internally set to half of the analog supply as defined by [Equation 29](#).

$$V_{OUT} = I_{IN} \times S + V_{OUT,0A} = I_{IN} \times S + V_S \times .05 \quad (29)$$

Design of the sensing solution focuses on maximizing the sensitivity of the device while maintaining linear measurement over the expected current input range. The TMCS1101 has a slightly smaller linear output range to the supply than to ground; therefore, the measurable current range is always constrained by the positive swing to supply, $Swing_{VS}$. To account for the operating margin, consider the minimum possible supply voltage $V_{S,min}$.

With the previous parameters, the maximum linear output voltage range is the range between $V_{OUT,max}$ and $V_{OUT,0A}$, as defined by Equation 30.

$$V_{OUT,max} - V_{OUT,0A} = V_{S,min} - \text{Swing}_{VS} - 0.5 \times V_{S,min} \quad (30)$$

Design parameters for this example application are shown in Table 10-4 along with the calculated output range.

Table 10-4. Example Application Design Parameters

DESIGN PARAMETER	EXAMPLE VALUE
Swing _{VS}	0.2 V
V _{OUT,max}	4.7 V
V _{OUT,0A} at V _{S,min}	2.45 V
V _{OUT,max} – V _{OUT,0A}	2.25 V

These design parameters result in a maximum positive linear output voltage swing of 2.25 V. To determine which sensitivity variant of the TMCS1101 most fully uses this linear range, calculate the maximum current range by Equation 31 for a bidirectional current ($I_{B,MAX}$).

$$I_{B,max} = (V_{OUT,max} - V_{OUT,0A}) / S_{A<x>} \quad (31)$$

where

- $S_{A<x>}$ is the sensitivity of the relevant A1-A4 variant.

Table 10-5 shows such calculation for each gain variant of the TMCS1101 with the appropriate sensitivities.

Table 10-5. Maximum Full-Scale Current Ranges With 2.25-V Positive Output Swing

SENSITIVITY VARIANT	SENSITIVITY	I _{B,MAX}
TMCS1101A1B	50 mV/A	±45 A
TMCS1101A2B	100 mV/A	±22.5 A
TMCS1101A3B	200 mV/A	±11.25 A
TMCS1101A4B	400 mV/A	±5.6 A

In general, the highest sensitivity variant that provides for the desired full-scale current range is selected. For the design parameters in this example, the TMCS1101A2B with a sensitivity of 0.1 V/A is the proper selection because the maximum calculated ±22.5-A linear measurable range is sufficient for the desired ±20-A full-scale current.

11 Power Supply Recommendations

The TMCS1101 only requires a power supply (V_S) on the low-voltage isolated side, which powers the analog circuitry independent of the isolated current input. V_S determines the full-scale output range of the analog output V_{OUT} , and can be supplied with any voltage between 3 V and 5.5 V. The TMCS1101 zero-current output voltage is derived from verses using a resistor divider; therefore, take care to optimize the power supply path for both noise and stability across temperature to provide the highest precision measurement. To filter noise in the power-supply path, place a low-ESR decoupling capacitor of 0.1 μF between V_S and GND pins as close as possible to the supply and ground pins of the device. To compensate for noisy or high-impedance power supplies, add more decoupling capacitance.

The TMCS1101 power supply V_S can be sequenced independently of current flowing through the input. However, there is a typical 25-ms delay between V_S reaching the recommended operating voltage and the analog output being valid. Within this delay V_{OUT} transfers from a high impedance state to the active drive state, during which time the output voltage could transition between GND and V_S . If this behavior must be avoided, a stable supply voltage to V_S should be provided for longer than 25 ms prior to applying input current.

12 Layout

12.1 Layout Guidelines

The TMCS1101 is specified for a continuous current handling capability on the [TMCS1101EVM](#), which uses 3-oz copper pour planes. This current capability is fundamentally limited by the maximum device junction temperature and the thermal environment, primarily the PCB layout and design. To maximize current-handling capability and thermal stability of the device, take care with PCB layout and construction to optimize the thermal capability. Efforts to improve the thermal performance beyond the design and construction of the [TMCS1101EVM](#) can result in increased continuous-current capability due to higher heat transfer to the ambient environment. Keys to improving thermal performance of the PCB include:

- Use large copper planes for both input current path and isolated power planes and signals.
- Use heavier copper PCB construction.
- Place thermal via *farms* around the isolated current input.
- Provide airflow across the surface of the PCB.

The TMCS1101 senses external magnetic fields, so make sure to minimize adjacent high-current traces in close proximity to the device. The input current trace can contribute additional magnetic field to the sensor if the input current traces are routed parallel to the vertical axis of the package. [Figure 12-1](#) illustrates the most optimal input current routing into the TMCS1101. As the angle that the current approaches the device deviates from 0° to the horizontal axis, the current trace contributes some additional magnetic field to the sensor, increasing the effective sensitivity of the device. If current must be routed parallel to the package vertical axis, move the routing away from the package to minimize the impact to the sensitivity of the device. Terminate the input current path directly underneath the package lead footprint, and use a merged copper input trace for both the IN+ and IN– inputs.

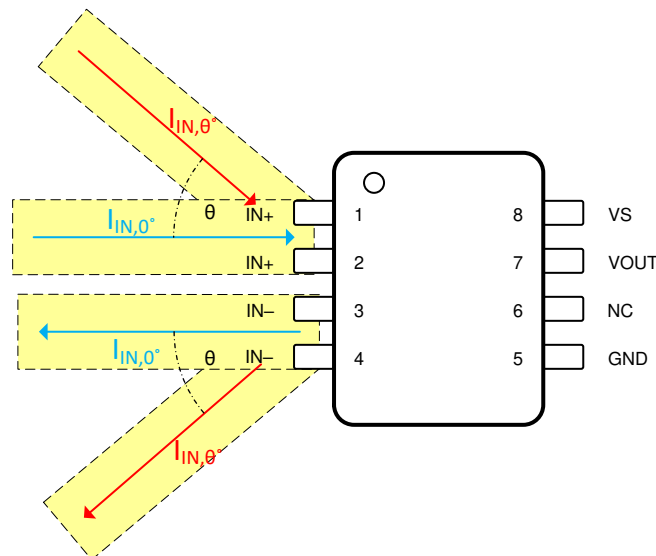

Figure 12-1. Magnetic Field Generated by Input Current Trace

In addition to thermal and magnetic optimization, make sure to consider the PCB design required creepage and clearance for system-level isolation requirements. Maintain required creepage between solder stencils, as shown in [Figure 12-2](#), if possible. If not possible to maintain required PCB creepage between the two isolated sides at board level, add additional slots or grooves to the board. If more creepage and clearance is required for system isolation levels than is provided by the package, the entire device and solder mask can be encapsulated with an overmold compound to meet system-level requirements.

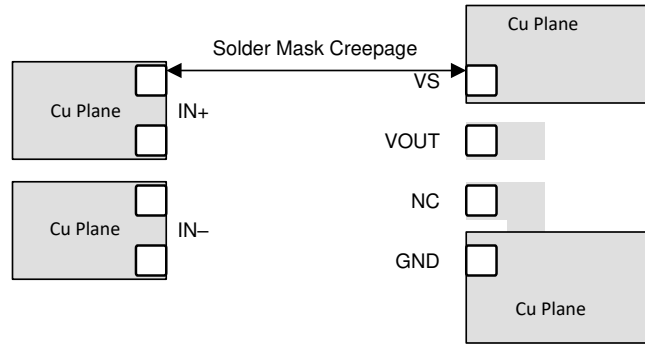

Figure 12-2. Layout for System Creepage Requirements

12.2 Layout Example

An example layout, shown in [Figure 12-3](#), is from the [TMCS1101EVM](#). Device performance is targeted for thermal and magnetic characteristics of this layout, which provides optimal current flow from the terminal connectors to the device input pins while large copper planes enhance thermal performance.

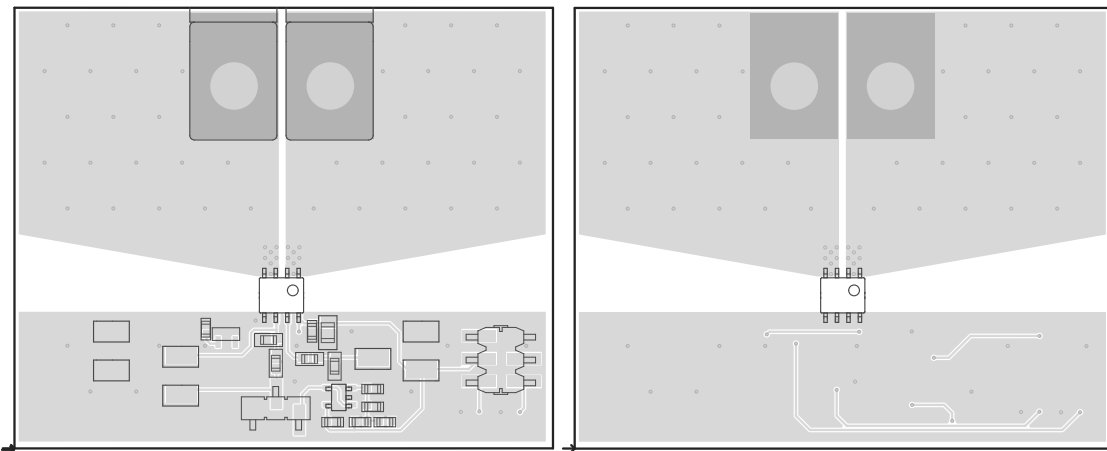

Figure 12-3. Recommended Board Top (Left) and Bottom (Right) Plane Layout

13 Device and Documentation Support

13.1 Device Support

13.1.1 Development Support

For development tool support see the following:

- [TMCS1101EVM](#)
- [TMCS1101 TI-TINA Model](#)
- [TMCS1101 TINA-TI Reference Design](#)

13.2 Documentation Support

13.2.1 Related Documentation

For related documentation see the following:

- Texas Instruments, [TMCS1101EVM User's Guide](#)
- Texas Instruments, [Enabling Precision Current Sensing Designs with Nonratiometric Magnetic Current Sensors](#)
- Texas Instruments, [Low-Drift, Precision, In-Line Isolated Magnetic Motor Current Measurements](#)
- Texas Instruments, [Isolation Glossary](#)

13.3 Receiving Notification of Documentation Updates

To receive notification of documentation updates, navigate to the device product folder on [ti.com](#). Click on *Subscribe to updates* to register and receive a weekly digest of any product information that has changed. For change details, review the revision history included in any revised document.

13.4 Support Resources

[TI E2E™ support forums](#) are an engineer's go-to source for fast, verified answers and design help — straight from the experts. Search existing answers or ask your own question to get the quick design help you need.

Linked content is provided "AS IS" by the respective contributors. They do not constitute TI specifications and do not necessarily reflect TI's views; see TI's [Terms of Use](#).

13.5 Trademarks

TI E2E™ is a trademark of Texas Instruments.

All trademarks are the property of their respective owners.

13.6 Electrostatic Discharge Caution



This integrated circuit can be damaged by ESD. Texas Instruments recommends that all integrated circuits be handled with appropriate precautions. Failure to observe proper handling and installation procedures can cause damage.

ESD damage can range from subtle performance degradation to complete device failure. Precision integrated circuits may be more susceptible to damage because very small parametric changes could cause the device not to meet its published specifications.

13.7 Glossary

[TI Glossary](#) This glossary lists and explains terms, acronyms, and definitions.

14 Mechanical, Packaging, and Orderable Information

The following pages include mechanical, packaging, and orderable information. This information is the most current data available for the designated devices. This data is subject to change without notice and revision of this document. For browser-based versions of this data sheet, refer to the left-hand navigation.



D0008B

PACKAGE OUTLINE
SOIC - 1.75 mm max height

SMALL OUTLINE INTEGRATED CIRCUIT

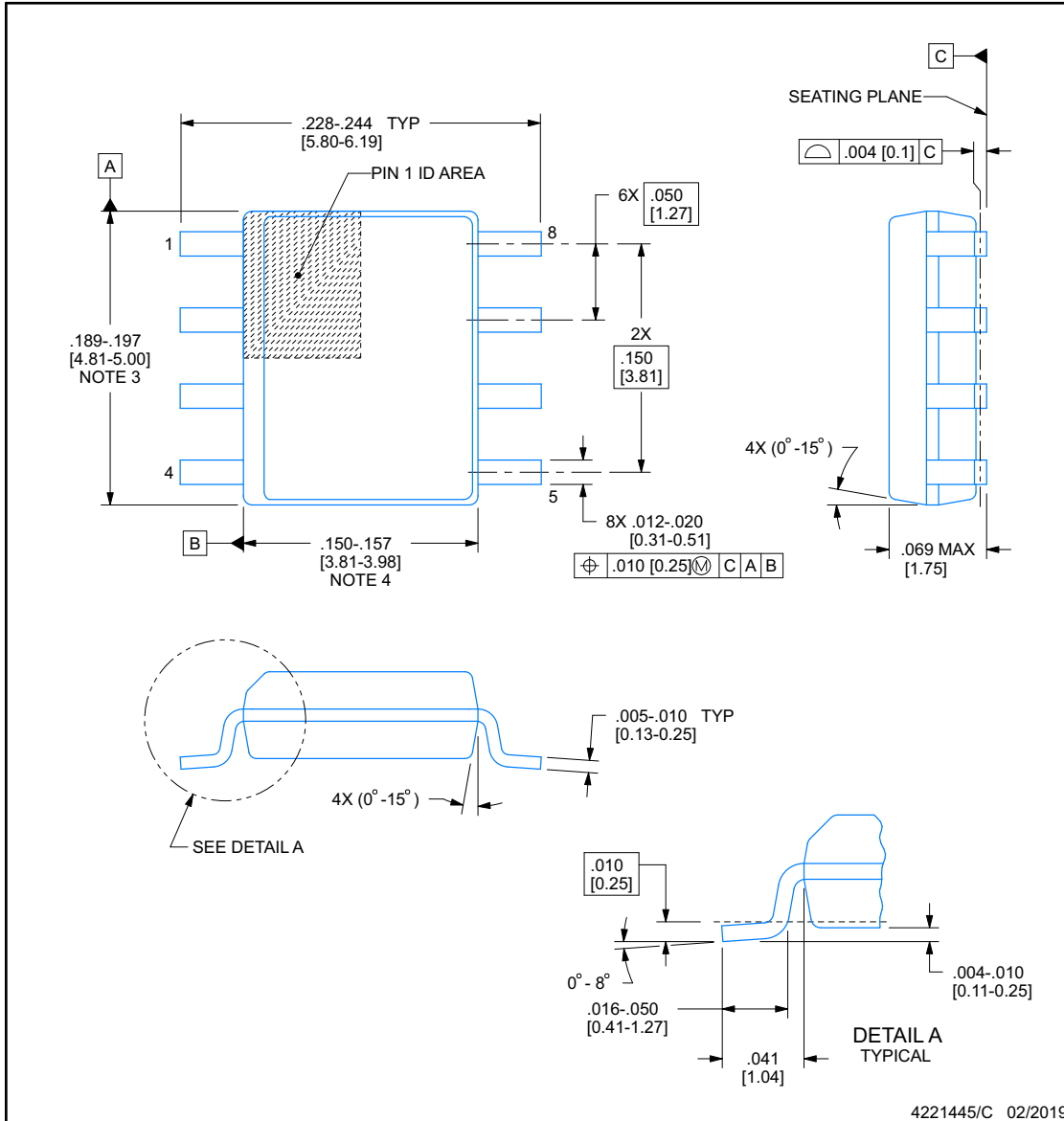

NOTES:

1. Linear dimensions are in inches [millimeters]. Dimensions in parenthesis are for reference only. Controlling dimensions are in inches. Dimensioning and tolerancing per ASME Y14.5M.
2. This drawing is subject to change without notice.
3. This dimension does not include mold flash, protrusions, or gate burrs. Mold flash, protrusions, or gate burrs shall not exceed $.006$ [0.15], per side.
4. This dimension does not include interlead flash.
5. Reference JEDEC registration MS-012, variation AA.

EXAMPLE BOARD LAYOUT

D0008B

SOIC - 1.75 mm max height

SMALL OUTLINE INTEGRATED CIRCUIT

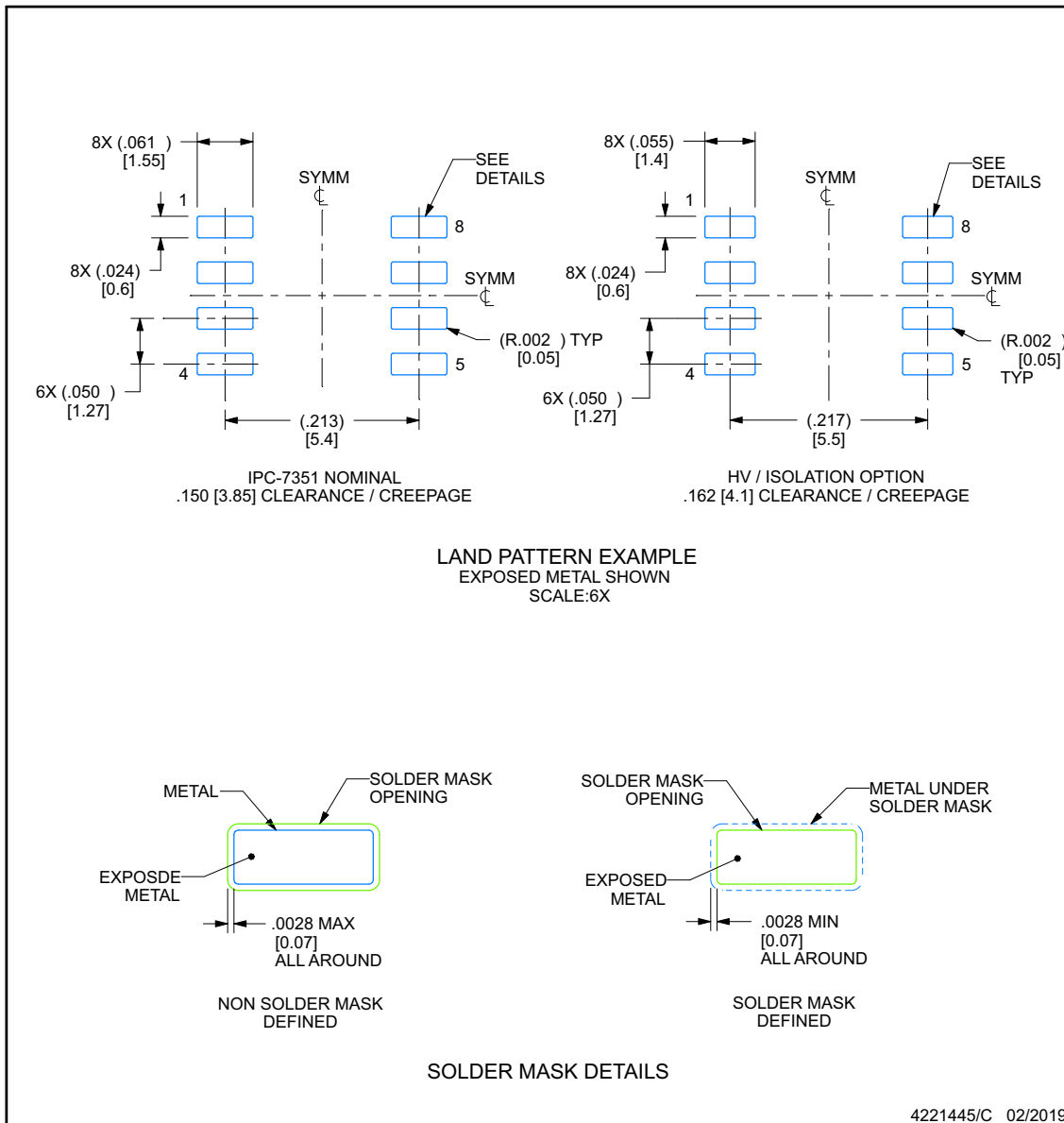

4221445/C 02/2019

NOTES: (continued)

- 6. Publication IPC-7351 may have alternate designs.
- 7. Solder mask tolerances between and around signal pads can vary based on board fabrication site.

EXAMPLE STENCIL DESIGN

D0008B

SOIC - 1.75 mm max height

SMALL OUTLINE INTEGRATED CIRCUIT

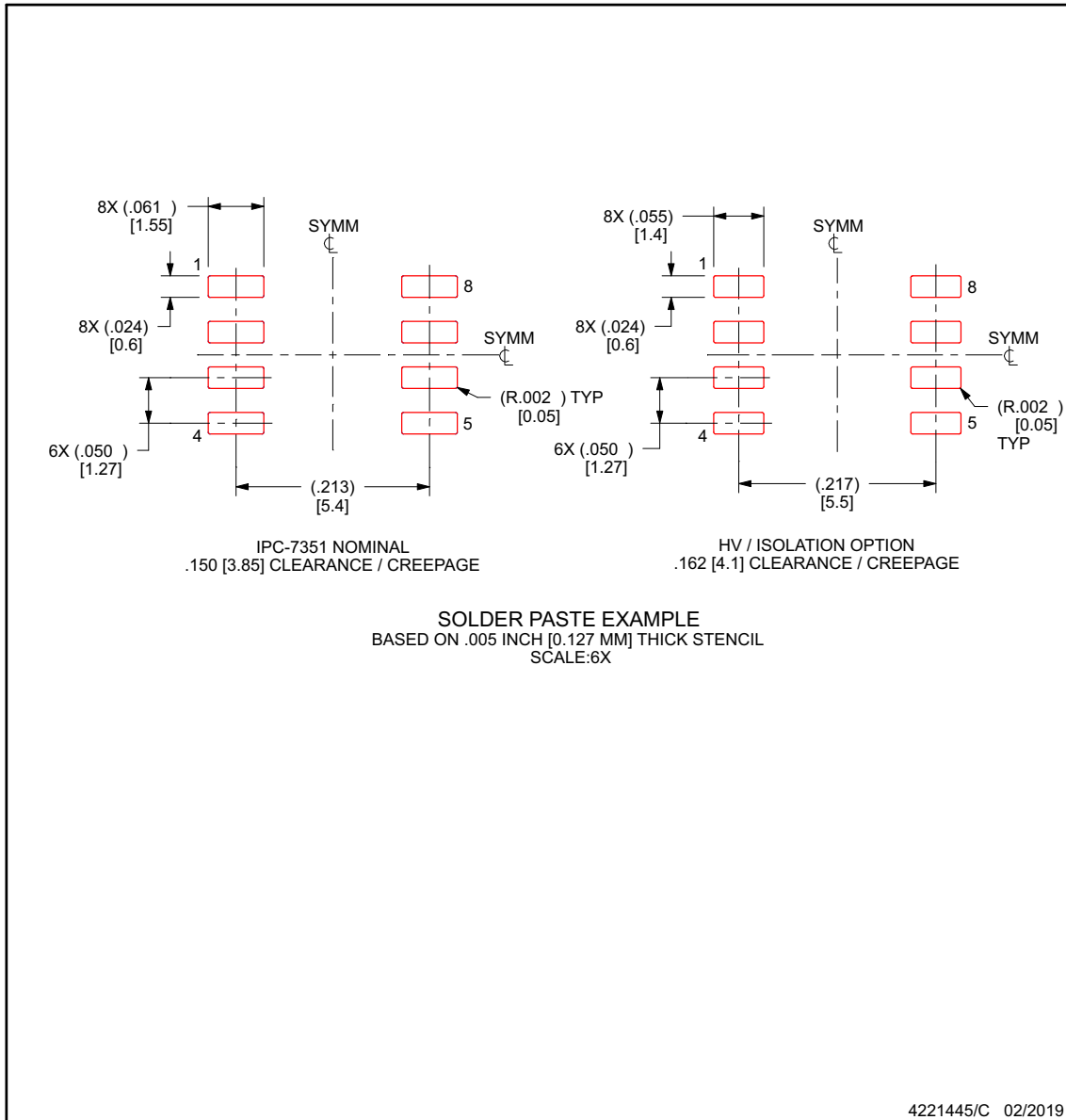

NOTES: (continued)

8. Laser cutting apertures with trapezoidal walls and rounded corners may offer better paste release. IPC-7525 may have alternate design recommendations.
9. Board assembly site may have different recommendations for stencil design.

PACKAGING INFORMATION

Orderable Device	Status (1)	Package Type	Package Drawing	Pins	Package Qty	Eco Plan (2)	Lead finish/ Ball material (6)	MSL Peak Temp (3)	Op Temp (°C)	Device Marking (4/5)	Samples
TMCS1101A1BQDR	ACTIVE	SOIC	D	8	2500	RoHS & Green	SN	Level-2-260C-1 YEAR	-40 to 125	M01A1B	Samples
TMCS1101A1BQDT	NRND	SOIC	D	8	250	RoHS & Green	SN	Level-2-260C-1 YEAR	-40 to 125	M01A1B	
TMCS1101A1UQDR	ACTIVE	SOIC	D	8	2500	RoHS & Green	SN	Level-2-260C-1 YEAR	-40 to 125	M01A1U	Samples
TMCS1101A1UQDT	NRND	SOIC	D	8	250	RoHS & Green	SN	Level-2-260C-1 YEAR	-40 to 125	M01A1U	
TMCS1101A2BQDR	ACTIVE	SOIC	D	8	2500	RoHS & Green	SN	Level-2-260C-1 YEAR	-40 to 125	M01A2B	Samples
TMCS1101A2UQDR	ACTIVE	SOIC	D	8	2500	RoHS & Green	SN	Level-2-260C-1 YEAR	-40 to 125	M01A2U	Samples
TMCS1101A2UQDT	NRND	SOIC	D	8	250	RoHS & Green	SN	Level-2-260C-1 YEAR	-40 to 125	M01A2U	
TMCS1101A3BQDR	ACTIVE	SOIC	D	8	2500	RoHS & Green	SN	Level-2-260C-1 YEAR	-40 to 125	M01A3B	Samples
TMCS1101A3BQDT	NRND	SOIC	D	8	250	RoHS & Green	SN	Level-2-260C-1 YEAR	-40 to 125	M01A3B	
TMCS1101A3UQDR	ACTIVE	SOIC	D	8	2500	RoHS & Green	SN	Level-2-260C-1 YEAR	-40 to 125	M01A3U	Samples
TMCS1101A3UQDT	ACTIVE	SOIC	D	8	250	RoHS & Green	SN	Level-2-260C-1 YEAR	-40 to 125	M01A3U	Samples
TMCS1101A4BQDR	ACTIVE	SOIC	D	8	2500	RoHS & Green	SN	Level-2-260C-1 YEAR	-40 to 125	M01A4B	Samples
TMCS1101A4BQDT	ACTIVE	SOIC	D	8	250	RoHS & Green	SN	Level-2-260C-1 YEAR	-40 to 125	M01A4B	Samples
TMCS1101A4UQDR	ACTIVE	SOIC	D	8	2500	RoHS & Green	SN	Level-2-260C-1 YEAR	-40 to 125	M01A4U	Samples
TMCS1101A4UQDT	ACTIVE	SOIC	D	8	250	RoHS & Green	SN	Level-2-260C-1 YEAR	-40 to 125	M01A4U	Samples

(1) The marketing status values are defined as follows:

ACTIVE: Product device recommended for new designs.

LIFEBUY: TI has announced that the device will be discontinued, and a lifetime-buy period is in effect.

NRND: Not recommended for new designs. Device is in production to support existing customers, but TI does not recommend using this part in a new design.

PREVIEW: Device has been announced but is not in production. Samples may or may not be available.

OBSOLETE: TI has discontinued the production of the device.

(2) **RoHS:** TI defines "RoHS" to mean semiconductor products that are compliant with the current EU RoHS requirements for all 10 RoHS substances, including the requirement that RoHS substance do not exceed 0.1% by weight in homogeneous materials. Where designed to be soldered at high temperatures, "RoHS" products are suitable for use in specified lead-free processes. TI may reference these types of products as "Pb-Free".

RoHS Exempt: TI defines "RoHS Exempt" to mean products that contain lead but are compliant with EU RoHS pursuant to a specific EU RoHS exemption.

Green: TI defines "Green" to mean the content of Chlorine (Cl) and Bromine (Br) based flame retardants meet JS709B low halogen requirements of ≤ 1000 ppm threshold. Antimony trioxide based flame retardants must also meet the ≤ 1000 ppm threshold requirement.

- (3) MSL, Peak Temp. - The Moisture Sensitivity Level rating according to the JEDEC industry standard classifications, and peak solder temperature.
- (4) There may be additional marking, which relates to the logo, the lot trace code information, or the environmental category on the device.
- (5) Multiple Device Markings will be inside parentheses. Only one Device Marking contained in parentheses and separated by a "~" will appear on a device. If a line is indented then it is a continuation of the previous line and the two combined represent the entire Device Marking for that device.
- (6) Lead finish/Ball material - Orderable Devices may have multiple material finish options. Finish options are separated by a vertical ruled line. Lead finish/Ball material values may wrap to two lines if the finish value exceeds the maximum column width.

Important Information and Disclaimer: The information provided on this page represents TI's knowledge and belief as of the date that it is provided. TI bases its knowledge and belief on information provided by third parties, and makes no representation or warranty as to the accuracy of such information. Efforts are underway to better integrate information from third parties. TI has taken and continues to take reasonable steps to provide representative and accurate information but may not have conducted destructive testing or chemical analysis on incoming materials and chemicals. TI and TI suppliers consider certain information to be proprietary, and thus CAS numbers and other limited information may not be available for release.

In no event shall TI's liability arising out of such information exceed the total purchase price of the TI part(s) at issue in this document sold by TI to Customer on an annual basis.

OTHER QUALIFIED VERSIONS OF TMCS1101 :

- Automotive : [TMCS1101-Q1](#)

NOTE: Qualified Version Definitions:

- Automotive - Q100 devices qualified for high-reliability automotive applications targeting zero defects

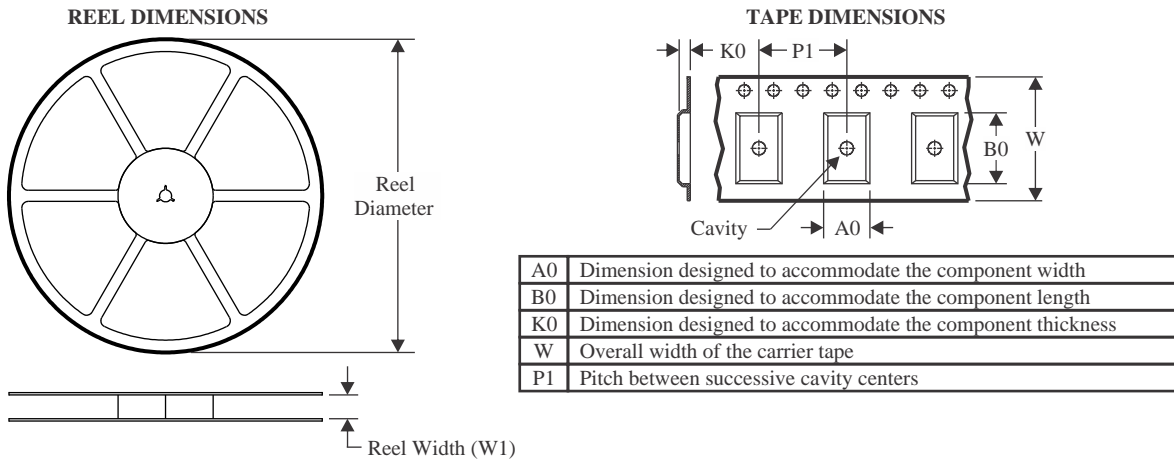
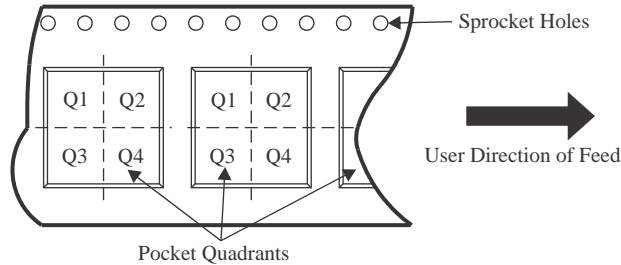
TAPE AND REEL INFORMATION

QUADRANT ASSIGNMENTS FOR PIN 1 ORIENTATION IN TAPE

*All dimensions are nominal

Device	Package Type	Package Drawing	Pins	SPQ	Reel Diameter (mm)	Reel Width W1 (mm)	A0 (mm)	B0 (mm)	K0 (mm)	P1 (mm)	W (mm)	Pin1 Quadrant
TMCS1101A1BQDR	SOIC	D	8	2500	330.0	12.4	6.4	5.2	2.1	8.0	12.0	Q1
TMCS1101A1BQDT	SOIC	D	8	250	330.0	12.4	6.4	5.2	2.1	8.0	12.0	Q1
TMCS1101A1UQDR	SOIC	D	8	2500	330.0	12.4	6.4	5.2	2.1	8.0	12.0	Q1
TMCS1101A1UQDT	SOIC	D	8	250	330.0	12.4	6.4	5.2	2.1	8.0	12.0	Q1
TMCS1101A2BQDR	SOIC	D	8	2500	330.0	12.4	6.4	5.2	2.1	8.0	12.0	Q1
TMCS1101A2UQDR	SOIC	D	8	2500	330.0	12.4	6.4	5.2	2.1	8.0	12.0	Q1
TMCS1101A2UQDT	SOIC	D	8	250	330.0	12.4	6.4	5.2	2.1	8.0	12.0	Q1
TMCS1101A3BQDR	SOIC	D	8	2500	330.0	12.4	6.4	5.2	2.1	8.0	12.0	Q1
TMCS1101A3BQDT	SOIC	D	8	250	330.0	12.4	6.4	5.2	2.1	8.0	12.0	Q1
TMCS1101A3UQDR	SOIC	D	8	2500	330.0	12.4	6.4	5.2	2.1	8.0	12.0	Q1
TMCS1101A3UQDT	SOIC	D	8	250	330.0	12.4	6.4	5.2	2.1	8.0	12.0	Q1
TMCS1101A4BQDR	SOIC	D	8	2500	330.0	12.4	6.4	5.2	2.1	8.0	12.0	Q1
TMCS1101A4BQDT	SOIC	D	8	250	330.0	12.4	6.4	5.2	2.1	8.0	12.0	Q1
TMCS1101A4UQDR	SOIC	D	8	2500	330.0	12.4	6.4	5.2	2.1	8.0	12.0	Q1
TMCS1101A4UQDT	SOIC	D	8	250	330.0	12.4	6.4	5.2	2.1	8.0	12.0	Q1

TAPE AND REEL BOX DIMENSIONS

*All dimensions are nominal

Device	Package Type	Package Drawing	Pins	SPQ	Length (mm)	Width (mm)	Height (mm)
TMCS1101A1BQDR	SOIC	D	8	2500	350.0	350.0	43.0
TMCS1101A1BQDT	SOIC	D	8	250	350.0	350.0	43.0
TMCS1101A1UQDR	SOIC	D	8	2500	350.0	350.0	43.0
TMCS1101A1UQDT	SOIC	D	8	250	350.0	350.0	43.0
TMCS1101A2BQDR	SOIC	D	8	2500	350.0	350.0	43.0
TMCS1101A2UQDR	SOIC	D	8	2500	350.0	350.0	43.0
TMCS1101A2UQDT	SOIC	D	8	250	350.0	350.0	43.0
TMCS1101A3BQDR	SOIC	D	8	2500	350.0	350.0	43.0
TMCS1101A3BQDT	SOIC	D	8	250	350.0	350.0	43.0
TMCS1101A3UQDR	SOIC	D	8	2500	350.0	350.0	43.0
TMCS1101A3UQDT	SOIC	D	8	250	350.0	350.0	43.0
TMCS1101A4BQDR	SOIC	D	8	2500	350.0	350.0	43.0
TMCS1101A4BQDT	SOIC	D	8	250	350.0	350.0	43.0
TMCS1101A4UQDR	SOIC	D	8	2500	350.0	350.0	43.0
TMCS1101A4UQDT	SOIC	D	8	250	350.0	350.0	43.0

IMPORTANT NOTICE AND DISCLAIMER

TI PROVIDES TECHNICAL AND RELIABILITY DATA (INCLUDING DATA SHEETS), DESIGN RESOURCES (INCLUDING REFERENCE DESIGNS), APPLICATION OR OTHER DESIGN ADVICE, WEB TOOLS, SAFETY INFORMATION, AND OTHER RESOURCES "AS IS" AND WITH ALL FAULTS, AND DISCLAIMS ALL WARRANTIES, EXPRESS AND IMPLIED, INCLUDING WITHOUT LIMITATION ANY IMPLIED WARRANTIES OF MERCHANTABILITY, FITNESS FOR A PARTICULAR PURPOSE OR NON-INFRINGEMENT OF THIRD PARTY INTELLECTUAL PROPERTY RIGHTS.

These resources are intended for skilled developers designing with TI products. You are solely responsible for (1) selecting the appropriate TI products for your application, (2) designing, validating and testing your application, and (3) ensuring your application meets applicable standards, and any other safety, security, regulatory or other requirements.

These resources are subject to change without notice. TI grants you permission to use these resources only for development of an application that uses the TI products described in the resource. Other reproduction and display of these resources is prohibited. No license is granted to any other TI intellectual property right or to any third party intellectual property right. TI disclaims responsibility for, and you will fully indemnify TI and its representatives against, any claims, damages, costs, losses, and liabilities arising out of your use of these resources.

TI's products are provided subject to [TI's Terms of Sale](#) or other applicable terms available either on [ti.com](https://www.ti.com) or provided in conjunction with such TI products. TI's provision of these resources does not expand or otherwise alter TI's applicable warranties or warranty disclaimers for TI products.

TI objects to and rejects any additional or different terms you may have proposed.

Mailing Address: Texas Instruments, Post Office Box 655303, Dallas, Texas 75265
Copyright © 2024, Texas Instruments Incorporated

Looking for pricing, stock, or lifecycle information?

Click below to explore more details on WIN SOURCE:

 [View TMCS1101A4UQDR on WIN SOURCE](#)

 [Texas Instruments](#) Information

Optimize Your Supply Chain with WIN SOURCE Solutions

-  Global Sourcing Solution
-  Obsolete Management
-  Cost Control Management
-  Shortage Management
-  Alternative Solution
-  Excess Inventory Management