



# THE DATASHEET OF HMC363S8G





## SMT GaAs HBT MMIC DIVIDE-BY-8, DC - 12 GHz

### Typical Applications

Prescaler for DC to X Band PLL Applications:

- Satellite Communication Systems
- Fiber Optic
- Point-to-Point and Point-to-Multi-Point Radios
- VSAT

### Features

- Ultra Low SSB Phase Noise: -153 dBc/Hz
- Wide Bandwidth
- Output Power: -6 dBm
- Single DC Supply: +5V
- S8G SMT Package

### Functional Diagram

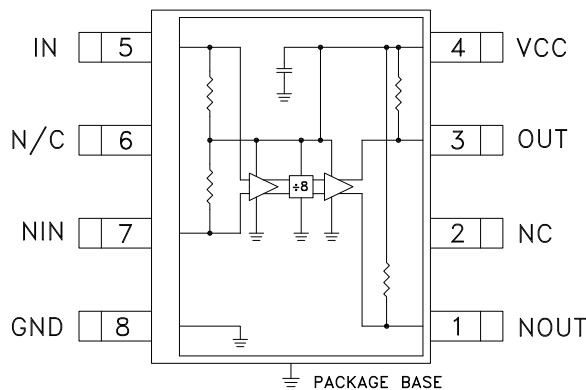

### General Description

The HMC363S8G & HMC363S8GE are low noise Divide-by-8 Static Dividers with InGaP GaAs HBT technology in 8 lead surface mount plastic packages. This device operates from DC (with a square wave input) to 12 GHz input frequency with a single +5V DC supply. The low additive SSB phase noise of -153 dBc/Hz at 100 kHz offset helps the user maintain good system noise performance.

### Electrical Specifications, $T_A = +25^\circ\text{C}$ , 50 Ohm System, $V_{CC} = 5V$

Parameter	Conditions	Min.	Typ.	Max.	Units
Maximum Input Frequency		12	13		GHz
Minimum Input Frequency	Sine Wave Input. [1]		0.2	0.5	GHz
Input Power Range	$F_{in} = 1$ to 7 GHz	-15	>-20	+10	dBm
	$F_{in} = 7$ to 11 GHz	-10	>-15	+2	dBm
	$F_{in} = 11$ to 12 GHz	-5	>-8	0	dBm
Output Power	$F_{in} = 12$ GHz	-9	-6		dBm
Reverse Leakage	Both RF Outputs Terminated		65		dB
SSB Phase Noise (100 kHz offset)	$P_{in} = 0$ dBm, $F_{in} = 6$ GHz		-153		dBc/Hz
Output Transition Time	$P_{in} = 0$ dBm, $F_{out} = 882$ MHz		100		ps
Supply Current ( $I_{CC}$ )			70		mA

1. Divider will operate down to DC for square-wave input signal.



**SMT GaAs HBT MMIC  
DIVIDE-BY-8, DC - 12 GHz**

**Input Sensitivity Window, T= 25 °C**

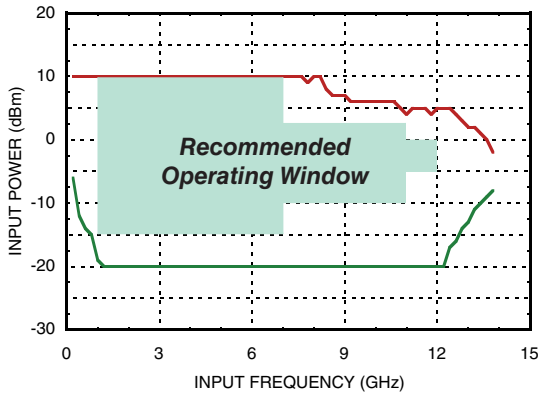

**Input Sensitivity Window vs. Temperature**

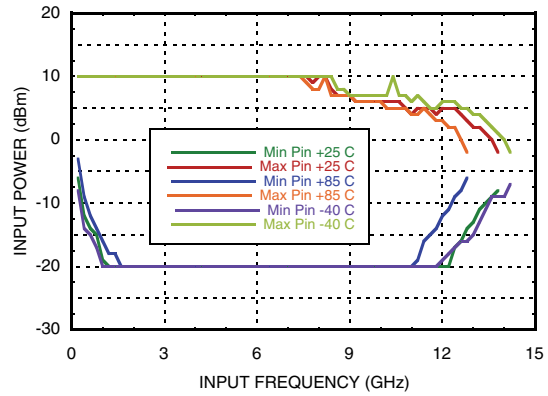

**Output Power vs. Temperature**

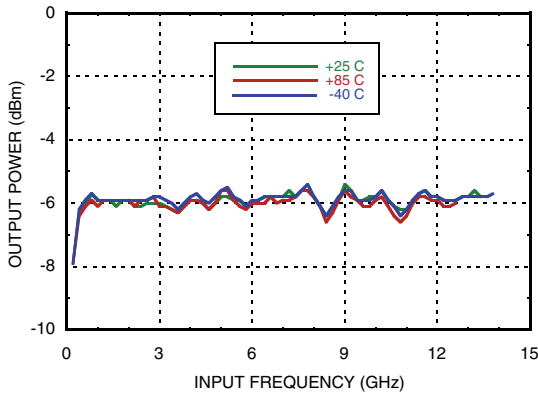

**SSB Phase Noise**

**Performance, Pin= 0 dBm, T= 25 °C**

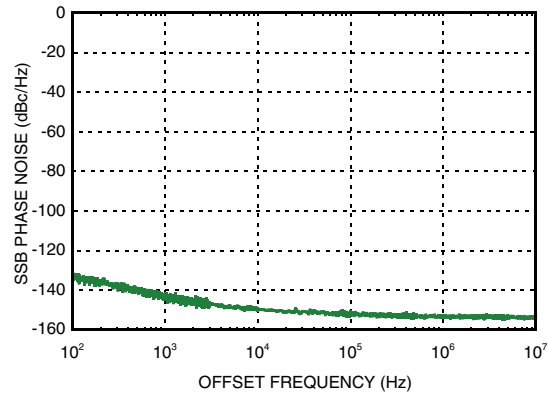

**Output Harmonic**

**Content, Pin= 0 dBm, T= 25 °C**

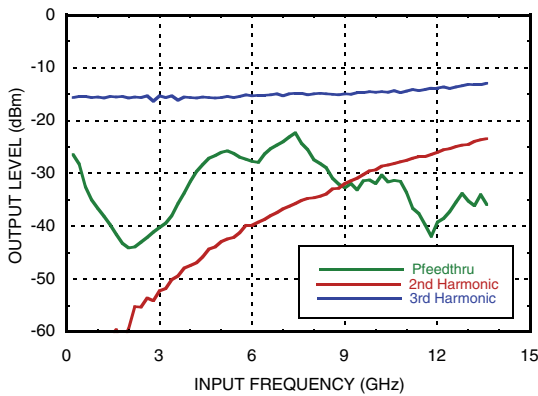

**Reverse Leakage, Pin= 0 dBm, T= 25 °C**

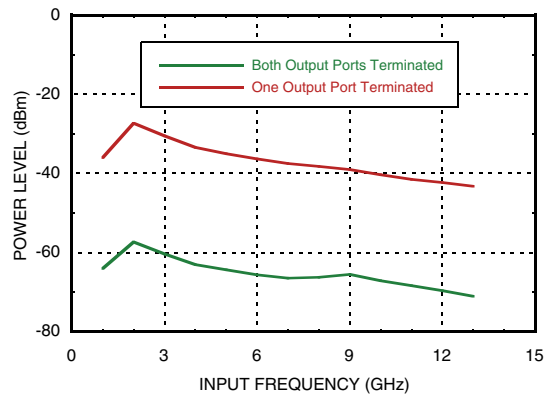



## SMT GaAs HBT MMIC DIVIDE-BY-8, DC - 12 GHz

**Output Voltage Waveform,  
Pin= 0 dBm, Fout= 882 MHz, T= 25 °C**

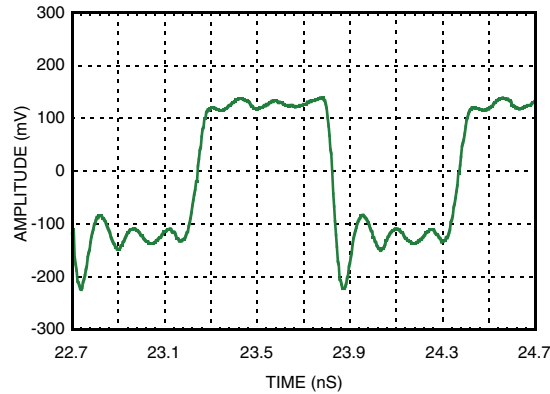

### Absolute Maximum Ratings

RF Input (Vcc = +5V)	+13 dBm
Vcc	+5.5V
Channel Temperature	135 °C
Continuous Pdiss (T=85°C) (derate 13.7 mW/°C above 85°C)	680 mW
Thermal Resistance (channel to ground paddle)	73.2 C/W
Storage Temperature	-65 to +150 °C
Operating Temperature	-40 to +85 °C

### Typical Supply Current vs. Vcc

Vcc (V)	Icc (mA)
4.75	64
5.0	70
5.25	75

Note: Divider will operate over full voltage range shown above



**ELECTROSTATIC SENSITIVE DEVICE  
OBSERVE HANDLING PRECAUTIONS**



## SMT GaAs HBT MMIC DIVIDE-BY-8, DC - 12 GHz

### Outline Drawing

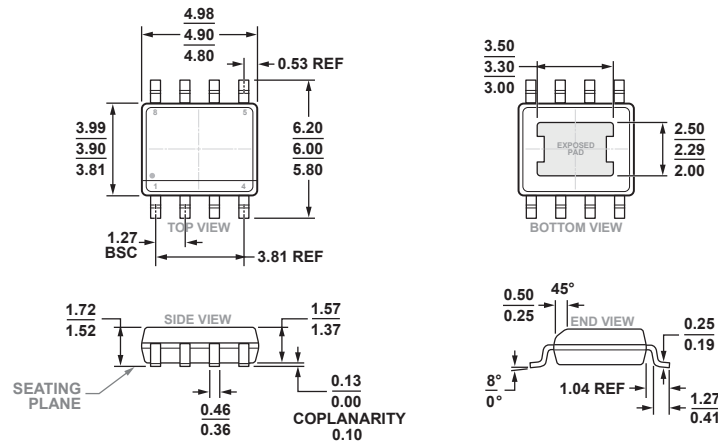

COMPLIANT TO JEDEC STANDARDS MS-012-BA

8-Lead Standard Small Outline Package, with Exposed Pad [SOIC\_N\_EP]  
 Narrow Body, Low Stand-off  
 (RD-8-3)  
 Dimensions shown in millimeters.

### Package Information

Part Number	Package Body Material	Lead Finish	MSL Rating	Package Marking <sup>[3]</sup>
HMC363S8G	Low Stress Injection Molded Plastic	Sn/Pb Solder	MSL1 <sup>[1]</sup>	HMC363 XXXX
HMC363S8GTR	Low Stress Injection Molded Plastic	Sn/Pb Solder	MSL1 <sup>[1]</sup>	HMC363 XXXX
HMC363S8GE	RoHS-compliant Low Stress Injection Molded Plastic	100% matte Sn	MSL1 <sup>[2]</sup>	HMC363 XXXX
HMC363S8GETR	RoHS-compliant Low Stress Injection Molded Plastic	100% matte Sn	MSL1 <sup>[2]</sup>	HMC363 XXXX
104631- HMC363S8G	Eval Board			

[1] Max peak reflow temperature of 235 °C

[2] Max peak reflow temperature of 260 °C

[3] 4-Digit lot number XXXX



**SMT GaAs HBT MMIC  
DIVIDE-BY-8, DC - 12 GHz**

**Pin Description**

Pin Number	Function	Description	Interface Schematic
1	NOUT	Divided output 180° out of phase with pin 3.	
2, 6	N/C	No connection. These pins must not be grounded.	
3	OUT	Divided Output.	
4	VCC	Supply voltage 5V ± 0.25V.	
5	IN	RF Input must be DC blocked.	
7	NIN	RF Input 180° out of phase with pin 5 for differential operation. A/C ground for single ended operation	
8, paddle	GND	Backside of package has exposed metal ground slug which must be connected to ground.	

**Application Circuit**

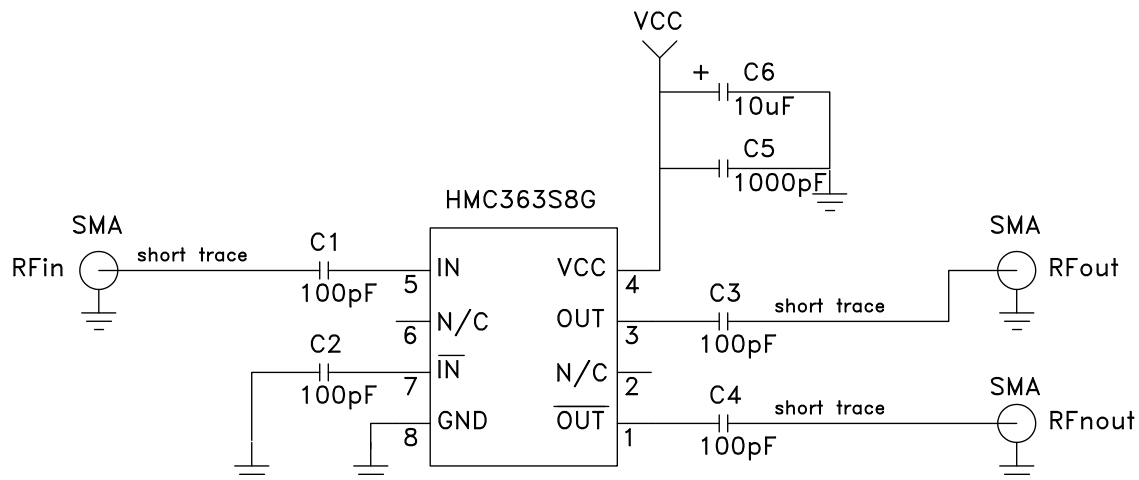



**Evaluation PCB**

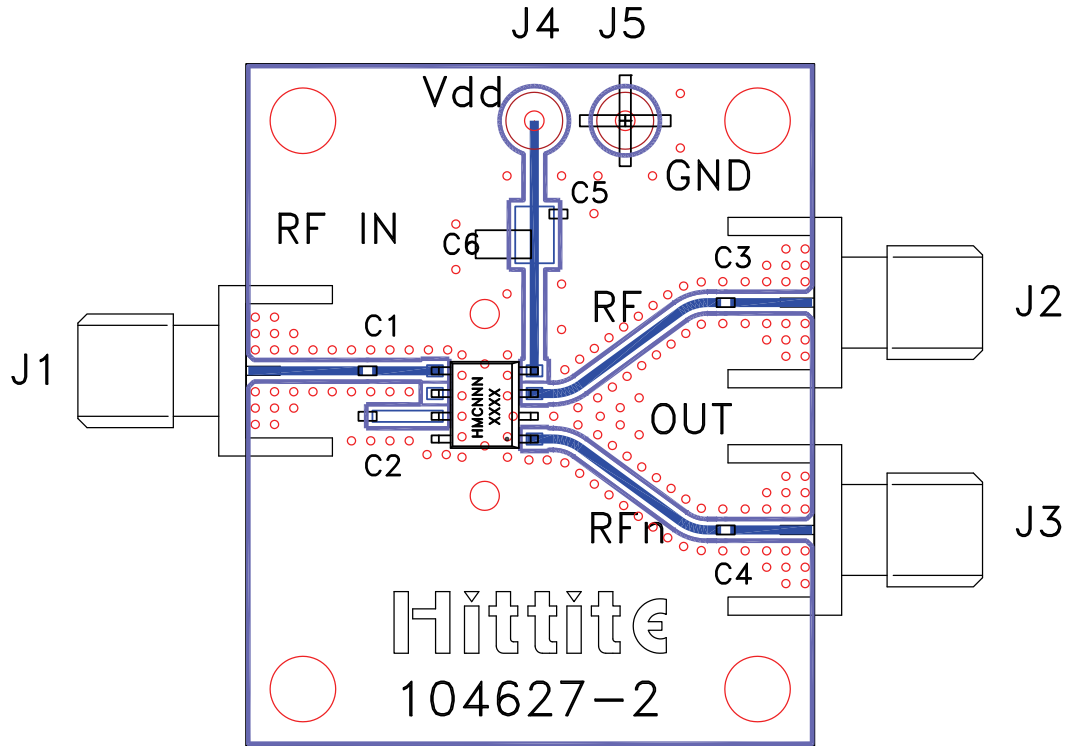

**List of Materials for Evaluation PCB 104631 [1]**

Item	Description
J1 - J3	PCB Mount SMA RF Connector
C1 - C4	100 pF Capacitor, 0402 Pkg.
C5	1000 pF Capacitor, 0603 Pkg.
C6	10 $\mu$ F Tantalum Capacitor
U1	HMC363S8G / HMC363S8GE Divide-by-8
PCB [2]	104627 Eval Board

[1] Reference this number when ordering complete evaluation PCB

[2] Circuit Board Material: Rogers 4350

The circuit board used in the application should use RF circuit design techniques. Signal lines should have 50 Ohm impedance while the package ground leads and backside ground slug should be connected directly to the ground plane similar to that shown. A sufficient number of via holes should be used to connect the top and bottom ground planes. The evaluation circuit board shown is available from Analog Devices upon request. This evaluation board is designed for single ended input testing. J2 and J3 provide differential output signals.

## Looking for pricing, stock, or lifecycle information?

Click below to explore more details on WIN SOURCE:

 [View HMC363S8G on WIN SOURCE](#)

 [Analog Devices Inc. Information](#)

## Optimize Your Supply Chain with WIN SOURCE Solutions

-  Global Sourcing Solution
-  Obsolete Management
-  Cost Control Management
-  Shortage Management
-  Alternative Solution
-  Excess Inventory Management