



**THE DATASHEET OF
PMA3-14LN+**





MMIC WIDEBAND, LOW NOISE

Monolithic Amplifier

PMA3-14LN+

50Ω 0.05 to 10 GHz

THE BIG DEAL

- Flat Gain, 22.6±0.7dB up to 10GHz
- P1dB, 22dBm typ. vs. OIP3, 30.4dBm Typ. up to 8GHz
- Low Noise Figure, 1.8dB Typ.
- Patent Pending

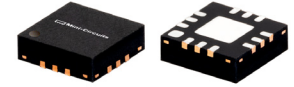

Generic photo used for illustration purposes only

CASE STYLE: DQ1225

+RoHS Compliant

The +Suffix identifies RoHS Compliance. See our website for methodologies and qualifications

APPLICATIONS

- Wi-Fi
- WLAN
- LTE/WCDMA/EDGE
- L, S and C-band Radar
- C-band Satcom

PRODUCT OVERVIEW

The PMA3-14LN+ is a GaAs PHEMT based wideband, low noise MMIC amplifier with a unique combination of low noise, high IP3, and high output power, over a wideband making it ideal for sensitive, high-dynamic range receiver applications. This design operates on a single supply of 6V, is well matched for 50Ω and comes in a tiny, low profile package (3 x 3 mm-12 lead), accommodating dense circuit board layouts.

KEY FEATURES

Feature	Advantages
Low noise, 1.8dB Typical up to 10GHz	Enables lower system noise figure performance.
High Dynamic Range <ul style="list-style-type: none"> • OIP3 30.4dBm Typ. up to 8GHz • P1dB 22dBm Typ. up to 8GHz 	The PMA3-14LN+ matches industry leading IP3 performance relative to device size and power consumption. The combination of the Design and PHEMT structure provides enhanced linearity over a board frequency range as evidence in the IP3 being approximately 9-11dB above the P1dB point. This feature makes this amplifier ideal for use in: <ul style="list-style-type: none"> • Driver Amplifiers for complex waveform up converter paths • Drivers in linearized transmit systems • Secondary amplifiers in ultra-high dynamic range receivers
3 x 3mm 12-lead MCLP package	Tiny footprint saves space in dense layouts while providing low inductance, repeatable transitions, and excellent thermal contact to the PCB.
Wide bandwidth with flat gain <ul style="list-style-type: none"> • ±0.7dB up to 10 GHz 	Enables a single amplifier to be used in many wideband applications including defense, instrumentation and more.

REV. A
ECO-018630
PMA3-14LN+
MCL NY
230724





MMIC WIDEBAND, LOW NOISE

Monolithic Amplifier

PMA3-14LN+

ELECTRICAL SPECIFICATIONS¹ AT 25°C AND 6V, UNLESS NOTED OTHERWISE

Parameter	Condition (MHz)	VDD = 6V			Units
		Min.	Typ.	Max.	
Frequency Range		50		10000	MHz
Gain	50	20.0	22.4	24.3	dB
	2000	20.0	22.6	24.4	
	4000	20.0	22.6	24.3	
	8000	20.3	23.1	24.9	
	10000	-	21.6	-	
Input Return Loss	50		20		dB
	2000		16		
	4000		14		
	8000		20		
	10000		13		
Output Return Loss	50		17		dB
	2000		20		
	4000		18		
	8000		16		
	10000		18		
P1dB	50		22.0		dBm
	2000		22.9		
	4000		22.0		
	8000		19.8		
	10000		16.6		
OIP3 Pout = -5dBm/Tone	50		31.2		dBm
	2000		31.8		
	4000		30.7		
	8000		28.7		
	10000		26.0		
Low Noise Figure	50		1.8		dB
	2000		1.0		
	4000		1.1		
	8000		1.2		
	10000		2.1		
Device Operating Voltage		5.75	6	6.25	V
Device Operating Current			67	90	mA
Device Current Variation Vs. Temperature ²			-23.1		uA/°C
Device Current Variation Vs. Voltage ³			0.0115		mA/mV
Thermal Resistance, Junction to Ground Lead, at 85° C Stage Temperature			53.9		°C/W

1. Measured on Mini-Circuits Characterization Test Board TB-PMA3-14LN+. See Characterization Test & Application Circuit (Fig. 1)

2. Device Current Variation vs. Temperature= (Current in mA at 85°C - Current in mA at -45°C)/130°C

3. Device Current Variation vs. Voltage = (Current in mA at 6.25V - Current in mA at 5.75V) / ((6.25V-5.75V) *1000 mA/mV)

MAXIMUM RATINGS⁴

Parameter	Ratings
Operating temperature (ground lead)	-40°C to 85°C
Storage temperature	-65°C to 150°C
Junction temperature	150°C
Total power dissipation	1.2 W
Input power (CW)	+25 dBm (5 minutes max.) +12 dBm (continuous)
DC voltage at VDD	8 V

4. Permanent damage may occur if any of those limits are exceeded. Electrical maximum ratings are not intended for continuous normal operation.





MMIC WIDEBAND, LOW NOISE

Monolithic Amplifier

PMA3-14LN+

SIMPLIFIED SCHEMATIC & PAD DESCRIPTION

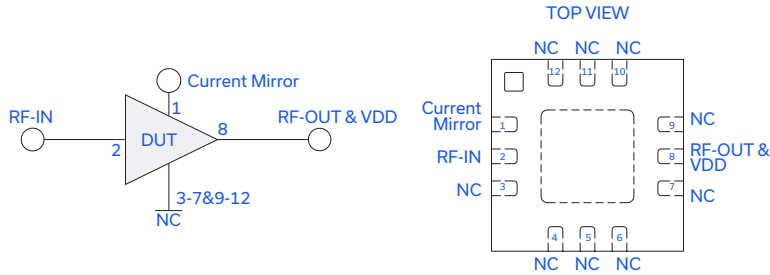

Function	Pad Number	Description (See Figure 1)
Current Mirror	1	Current Mirror Pad. Feedback to RF-IN via L1. See details in Figure 1.
RF-IN	2	RF Input Pad.
RF-OUT & VDD	8	RF Output Pad & DC Pad.
NC	10	No Connection, Even Soldered on Test Board.
NC	3-7,9,11 & 12	No Connection, Grounded on Test Board
GND	Paddle, Index	Ground

CHARACTERIZATION TEST AND APPLICATION CIRCUIT

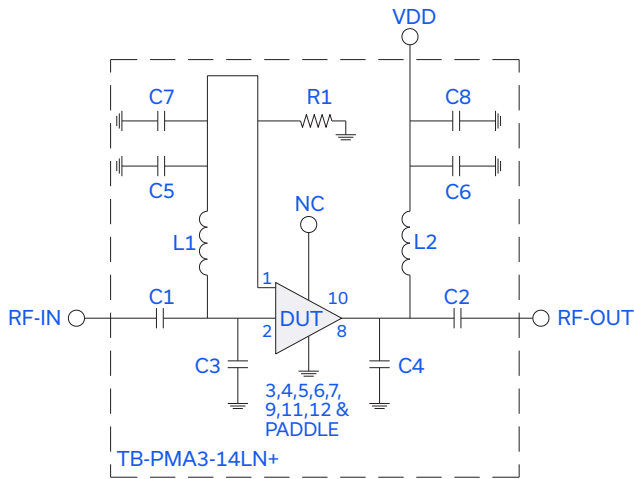

Fig 1. Application and Characterization Circuit

Note: This block diagram is used for characterization.

(DUT is soldered on Mini- Circuits Characterization test board TB-PMA3-14LN+) Gain, Return loss, Output power at 1dB compression (P1dB), output IP3 (OIP3) and noise figure measured using Agilent's N5242A PNA-X microwave network analyzer.

Conditions:

1. VDD=6V
2. Gain and Return loss: Pin= -25dBm
3. Output IP3 (OIP3): Two tones, spaced 1 MHz apart, -5 dBm/tone at output.

Component	Size	Value	Part Number	Manufacturer
C1 & C2	0402	0.01uF	GRM155R71H103KA88D	Murata
C3	0402	0.2pF	GJM1555C1HR20WB01D	Murata
C4	0402	0.1pF	GJM1555C1HR10WB01D	Murata
C5 & C6	0402	100pF	GRM1555C1H101JA01D	Murata
C7 & C8	0402	0.1uF	GRM155R71H104KE14J	Murata
L1 & L2	0402	900nH	0402DF-901XJRU	Coilcraft
R1	0402	510Ω	RK73H1ETTP5100F	KOA

PRODUCT MARKING

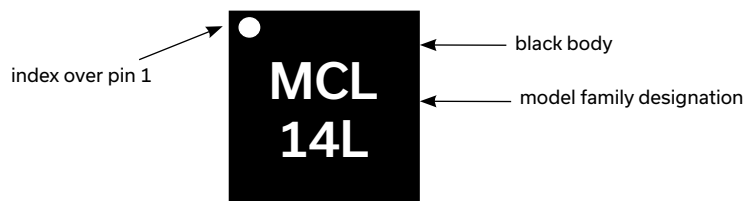

Marking may contain other features or characters for internal lot control





MMIC WIDEBAND, LOW NOISE

Monolithic Amplifier

PMA3-14LN+

Mini-Circuits

ADDITIONAL DETAILED TECHNICAL INFORMATION IS AVAILABLE ON OUR DASH BOARD. TO ACCESS [CLICK HERE](#)

Performance Data	Data Table
	Swept Graphs
	S-Parameter (S2P Files) Data Set (.zip file)
Case Style	DQ1225 Plastic package, exposed paddle, lead finish: Matte-Tin
Tape & Reel	F66
Standard quantities available on reel	7" reels with 20, 50, 100, 200, 500,1K or 2K devices
Suggested Layout for PCB Design	PL-725
Evaluation Board	TB-PMA3-14LN+
Environmental Ratings	ENV08T1

ESD RATING

Human Body Model (HBM): Class 1B(500V) in accordance with ANSI/ESD STM 5.1 - 2001

MSL RATING

Moisture Sensitivity: MSL1 in accordance with IPC/JEDEC J-STD-020D

MSL TEST FLOW CHART

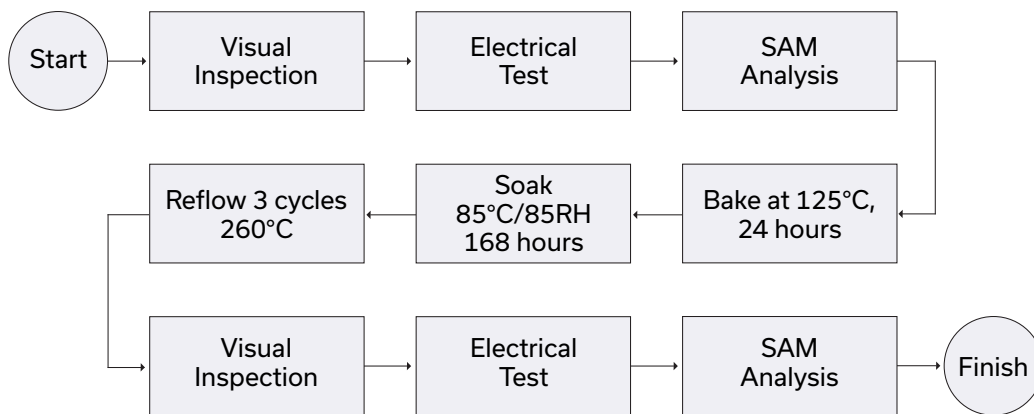



- NOTES**
- A. Performance and quality attributes and conditions not expressly stated in this specification document are intended to be excluded and do not form a part of this specification document.
 - B. Electrical specifications and performance data contained in this specification document are based on Mini-Circuit's applicable established test performance criteria and measurement instructions.
 - C. The parts covered by this specification document are subject to Mini-Circuits standard limited warranty and terms and conditions (collectively, "Standard Terms"); Purchasers of this part are entitled to the rights and benefits contained therein. For a full statement of the standard. Terms and the exclusive rights and remedies thereunder, please visit Mini-Circuits' website at www.minicircuits.com/MCLStore/terms.jsp



Looking for pricing, stock, or lifecycle information?

Click below to explore more details on WIN SOURCE:

-  [View PMA3-14LN+ on WIN SOURCE](#)
-  [Mini-Circuits Information](#)

Optimize Your Supply Chain with WIN SOURCE Solutions

-  Global Sourcing Solution
-  Obsolete Management
-  Cost Control Management
-  Shortage Management
-  Alternative Solution
-  Excess Inventory Management