



THE DATASHEET OF OY270KE



OX/OY Series

Ceramic Composition 10% Tolerance



The OX/OY Series of fixed ceramic resistors are ideal for circuitry associated with surges, high peak power or high energy. They offer enhanced performance in high voltage power supplies, R-C snubber circuits, and inrush limiters. The OX/OY resistors can often replace carbon composition resistors which can be difficult to source.

FEATURES

- Replaces 1 and 2 watt carbon composition resistors
- Meets high energy density demands
- High peak power
- 10% Tolerance



SERIES SPECIFICATIONS

Series	Watts max.*	Resistance range	Joules max.**	Max. working volts
OX	1	3.3Ω-100K	50	300
OY	2	3.3Ω-1M	80	400

* at 70°C. **For a single impulse.

CHARACTERISTICS

Terminals	Pb-free solder-coated axial	
Coating	Silicone ceramic	
Derating	Linear from 100% @ +70°C to 0% @ +200°C	
Operating Temp. Range	-40°C to +220°C	
Tolerance	±10% standard	
Power Rating	Based on 70°C free air rating	
Temperature Coefficient	-1300 ±300ppm/°C.	

	OX	OY
Max Working Voltage	300V	400V
Dielectric Strength	500V	700V
Max Overload Voltage	600V	800V
Max Pulse Voltage¹	14KV	20KV
Pulse Tolerance, 100 pulses	1240V @ 52μF, 40J/ 35 sec.	1640V @ 52μF, 70J/35 sec.

Test	Condition	Maximum ΔR
Life Test	MIL-STD-202, Method 108	±5%
Short Time Overload	2x rated V, 5 sec ON @ 70°C	±(2% +0.05Ω)
Resistance to Pulse¹	20,000 cycles. See circuit for test conditions	±5%
Thermal Shock	MIL-STD-202, Method 107	±(2% ±0.05Ω)
Moisture Resistance	1000 hrs @ 40°C, 90 - 95% RH	±5%

Resistance to Pulse

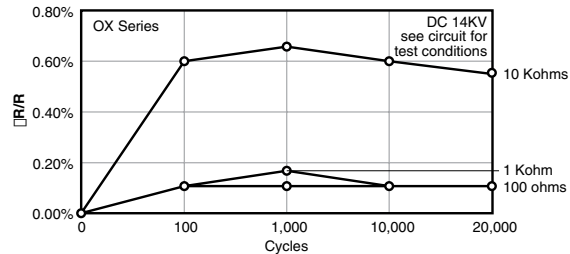
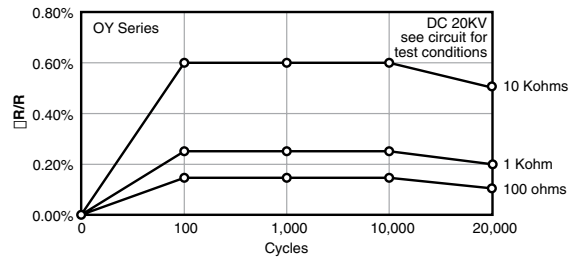

¹See figures

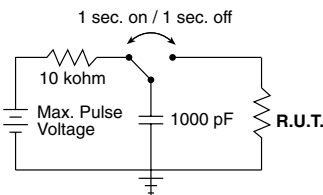

14KV and 20KV values used in circuit as shown; full voltage not applied directly to resistor.

(continued)

OX/OY Series

Ceramic Composition
10% Tolerance

DIMENSIONS

in./mm

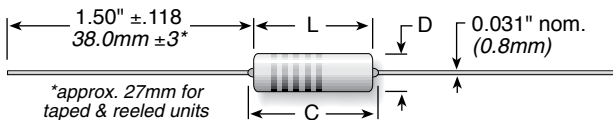

Series	Length L ±.039 (±1.0)	Length C max.	Diameter D ±.039 (±1.0)	Qty. per reel
OX	0.65 / 16.5	0.748 / 19.0	0.217 / 5.5	1000
OY	0.748 / 19.0	0.886 / 22.5	0.276 / 7.0	500

Tape and Reel Dimensions

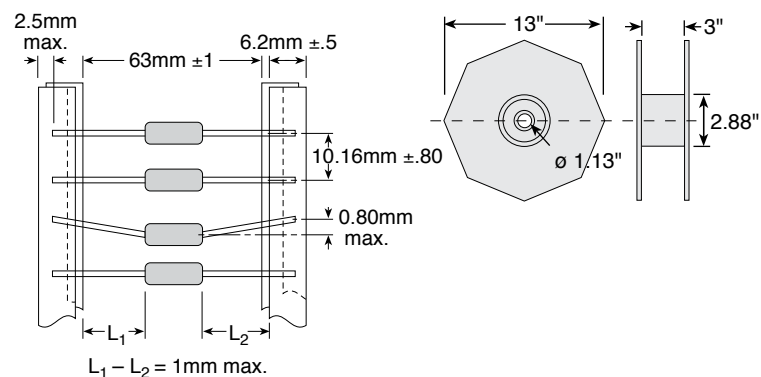

ORDERING INFORMATION

Standard part numbers for OX/OY Series

Ohmic value	Part No. Prefix Suffix	Wattage 1 2	Ohmic value	Part No. Prefix Suffix	Wattage 1 2	Ohmic value	Part No. Prefix Suffix	Wattage 1 2	Ohmic value	Part No. Prefix Suffix	Wattage 1 2	Ohmic value	Part No. Prefix Suffix	Wattage 1 2
3.3	—33GKE	✓ ✓	27	—270KE	✓ ✓	220	—221KE	✓ ✓	1800	—182KE	✓ ✓	15000	—153KE	✓ ✓
3.9	—39GKE	✓ ✓	33	—330KE	✓ ✓	270	—271KE	✓ ✓	2200	—222KE	✓ ✓	18000	—183KE	✓ ✓
4.7	—47GKE	✓ ✓	39	—390KE	✓ ✓	330	—331KE	✓ ✓	2700	—272KE	✓ ✓	22000	—223KE	✓ ✓
5.6	—56GKE	✓ ✓	47	—470KE	✓ ✓	390	—391KE	✓ ✓	3300	—332KE	✓ ✓	27000	—273KE	✓ ✓
6.8	—68GKE	✓ ✓	56	—560KE	✓ ✓	470	—471KE	✓ ✓	3900	—392KE	✓ ✓	33000	—333KE	✓ ✓
8.2	—82GKE	✓ ✓	68	—680KE	✓ ✓	560	—561KE	✓ ✓	4700	—472KE	✓ ✓	39000	—393KE	✓ ✓
10	—100KE	✓ ✓	82	—820KE	✓ ✓	680	—681KE	✓ ✓	5600	—562KE	✓ ✓	47000	—473KE	✓ ✓
12	—120KE	✓ ✓	100	—101KE	✓ ✓	820	—821KE	✓ ✓	6800	—682KE	✓ ✓	56000	—563KE	✓ ✓
15	—150KE	✓ ✓	120	—121KE	✓ ✓	1000	—102KE	✓ ✓	8200	—822KE	✓ ✓	68000	—683KE	✓ ✓
18	—180KE	✓ ✓	150	—151KE	✓ ✓	1200	—122KE	✓ ✓	10000	—103KE	✓ ✓	82000	—823KE	✓ ✓
22	—220KE	✓ ✓	180	—181KE	✓ ✓	1500	—152KE	✓ ✓	12000	—123KE	✓ ✓	100000	—104KE	✓ ✓
														1 MEG —105KE ✓ ✓

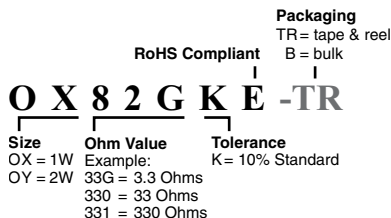

Looking for pricing, stock, or lifecycle information?

Click below to explore more details on WIN SOURCE:

 [View OY270KE](#) on WIN SOURCE

 [Ohmite](#) Information

Optimize Your Supply Chain with WIN SOURCE Solutions

-  Global Sourcing Solution
-  Obsolete Management
-  Cost Control Management
-  Shortage Management
-  Alternative Solution
-  Excess Inventory Management