

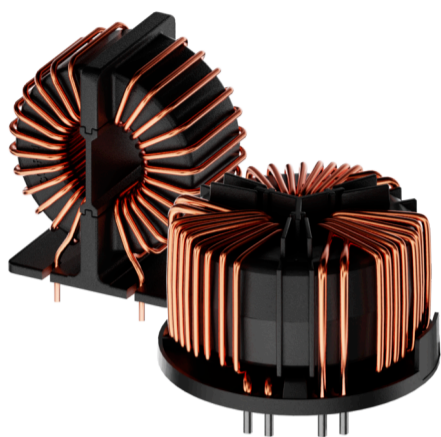

**THE DATASHEET OF  
RT8132-10-4M0**



# Current-Compensated Chokes - Ferrite Core



- Rated currents from 6 to 63 A
- Up to 600 VAC and VDC
- 2- and 3-wire configurations
- Horizontal and vertical PCB mounting types
- Ruggedized saturation and thermal behavior
- Open construction for forced and convection cooling
- Straightforward pin-out for easy PCB design
- Ferrite Core Technology



### Performance indicators

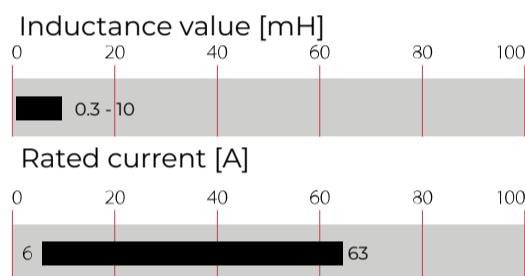

### Approvals & Compliances



EIS applicable for currents > 20A

RT common-mode chokes are mainly used to filter EMI noise on AC power lines up to 600 VAC. EMI noise of electronic equipment can go to the power lines and disturb the proper function of other devices like communication devices or control logic of robotics. Thus noise generated by the equipment from switched power electronics or by high slew rates of controllers needs to be filtered. RT common-mode chokes are used to suppress EMI noise in PCB integrated filter designs with line bypass capacitors or in combination with single phase filters for extra low leakage filter designs.

### Features and Benefits

- Cost-effective PCB designs for up to 100 A with forced cooling \*
- EIS (electrical insulation system E332676) for currents > 20A acc. to UL 1446
- Compact size and light weight
- Low magnetic leakage flux
- Excellent winding insulation
- Standardized foot print
- Broad range of inductance ratings
- Custom-specific versions on request











































## Technical Specifications

<b>Rated currents</b>	6 to 63 A @ 60°C
<b>Operating frequency</b>	DC to 400 Hz
<b>Creepage and clearance distances</b>	Creepage & Clearance (2-line): ≥ 3.5 mm (Coil - Coil) / ≥ 3.0 mm (Coil-Core) Creepage & Clearance (3-line): ≥ 6.3 mm (Coil - Coil) / ≥ 5.5 mm (Coil-Core)
<b>High potential test voltage</b>	3 kV DC 3s (coil to coil) Repetition with max. 80% of the HV test voltage
<b>Rated inductance</b>	0.3 to 6 mH (3-line) 0.5 to 10 mH (2-line)
<b>Operating voltage</b>	300 VAC/425 VDC (2-line) 600 VAC (3-line)
<b>Overvoltage category</b>	III (acc. IEC 60664-1)
<b>Pollution degree</b>	PD2 (acc. IEC60664-1)
<b>Stray inductance</b>	Max. 1% of rated inductance (@ 100 kHz 1 V, 0 A)
<b>Temperature range (operation and storage)</b>	-40°C to +100°C (6 to 20 A) / -40°C to +125°C (25 to 63 A)
<b>Climatic category</b>	40/100/56 (acc. IEC 60068-1) (6 to 20 A) / 40/125/56 (acc. IEC 60068-1) (25 to 63 A)
<b>Altitude</b>	2'000 m, current and voltage derating above
<b>Flammability corresponding to</b>	UL 94 V0
<b>Vibration and shock</b>	3M4 (according IEC 60721-3-3)
<b>Design corresponding to</b>	UL/IEC 60938-1/-2 UL1446 (>20A)
<b>MTBF (Mil-HB-217F)</b>	>2,000,000 h @ 60°C/300 V

### Typical Applications

- AC and DC filtering for midsize power range drives, photovoltaic inverters, fast chargers, EV charging stations, UPS and switch mode power supplies
- Filter with low leakage current noise or improved immunity against grid disturbances
- Electronic devices, automation and (industrial) LED lighting
- Communication devices
- Medical and laboratory equipment
- Converters

## RT Series

Selection table	Buy	Convection cooling nominal current @ 60°C [A]	*Forced cooling 3 m/s nominal current @ 60°C [A]	Inductance Ln @ 25°C 100kHz [mH/path]	Resistance R @ 25°C [mΩ/path]	Choke [size]	***Ø Pin ±0.1 ØP [mm]	Weight [g]
<b>Horizontal 2-line</b>								
RT8122-6-10M0		6	9.5	10.0	33.0	1	1.1	80
RT8122-8-8M0		8	12.5	8.0	21.0	1	1.3	80
RT8122-10-6M0		10	16	6.0	16.0	1	1.4	80
RT8122-12-5M0		12	19	5.0	14.0	2	1.5	100
RT8122-16-4M0		16	27	4.0	10.0	2	1.8	110
RT8122-20-3M0		20	32	3.0	7.0	3	2	160
RT8122-32-1M5		32	51	1.5	3.4	13	2.36	200
RT8122-40-1M2		40	64	1.2	2.2	13	2.8	210
RT8122-50-1M0		50	80	1.0	1.7	14	2x2.2	270
RT8122-63-0M5		63	100	0.5	1.1	14	2x2.36	260
<b>Vertical 2-line</b>								
RT8522-6-10M0		6	9.5	10.0	33.0	4	1.1	70
RT8522-8-8M0		8	12.5	8.0	21.0	4	1.3	80
RT8522-10-6M0		10	16	6.0	16.0	4	1.4	80
RT8522-12-5M0		12	19	5.0	14.0	5	1.5	90
RT8522-16-4M0		16	27	4.0	10.0	5	1.8	110
RT8522-20-3M0		20	32	3.0	7.0	6	2.0	150
RT8522-32-1M5		32	51	1.5	3.4	15	2.36	210
RT8522-40-1M2		40	64	1.2	2.2	15	2.8	220
RT8522-50-1M0		50	80	1.0	1.7	16	2x2.2	280
RT8522-63-0M5		63	100	0.5	1.0	16	2x2.36	270
<b>Horizontal 3-line</b>								
RT8132-6-6M0		6	9.5	6.0	27.0	7	1.1	80
RT8132-8-4M8		8	12.5	4.8	17.0	7	1.3	90
RT8132-10-4M0		10	16	4.0	15.0	8	1.5	110
RT8132-12-3M6		12	19	3.6	12.0	8	1.6	120
RT8132-16-3M0		16	27	3.0	8.0	9	1.8	170
RT8132-20-2M5		20	32	2.5	7.0	9	2.1	190
RT8132-25-1M5		25	40	1.5	3.5	17	2.4	240
RT8132-32-1M2		32	51	1.2	2.5	17	2.4	240
RT8132-40-0M7		40	64	0.7	1.9	18	2x1.9	270
RT8132-50-0M5		50	80	0.5	1.2	18	2x2.2	290
RT8132-63-0M3		63	100	0.3	0.7	18	2x2.6	300
<b>Vertical 3-line</b>								
RT8532-6-6M0		6	9.5	6.0	27.0	10	1.1	90
RT8532-8-4M8		8	12.5	4.8	17.0	10	1.3	90
RT8532-10-4M0		10	16	4.0	15.0	11	1.5	110
RT8532-12-3M6		12	19	3.6	12.0	11	1.6	120
RT8532-16-3M0		16	27	3.0	8.0	12	1.8	160
RT8532-20-2M5		20	32	2.5	7.0	12	2.1	190
RT8532-25-1M5		25	40	1.5	3.5	19	2.4	250
RT8532-32-1M2		32	51	1.2	2.5	19	2.4	250
RT8532-40-0M7		40	64	0.7	1.9	20	2x1.9	290
RT8532-50-0M5		50	80	0.5	1.2	20	2x2.2	290
RT8532-63-0M3		63	100	0.3	0.8	20	2x2.6	310

Test conditions: Inductance tolerance: +50%, -30%; Resistance tolerance: +15% @ 25°C; Electrical characteristics @ 25°C: ±2°C

\* typical current for forced cooling with 3 m/s. Due to the possible turbulences and degradation of the air stream within an equipment please consider thermal validation.

\*\* typical stray inductance, max is 0.1% of Ln

\*\*\* Length of pin (Dimension P) is always 5.5 mm ± 1

## Product selector

## RT8xxx-xx-xMx

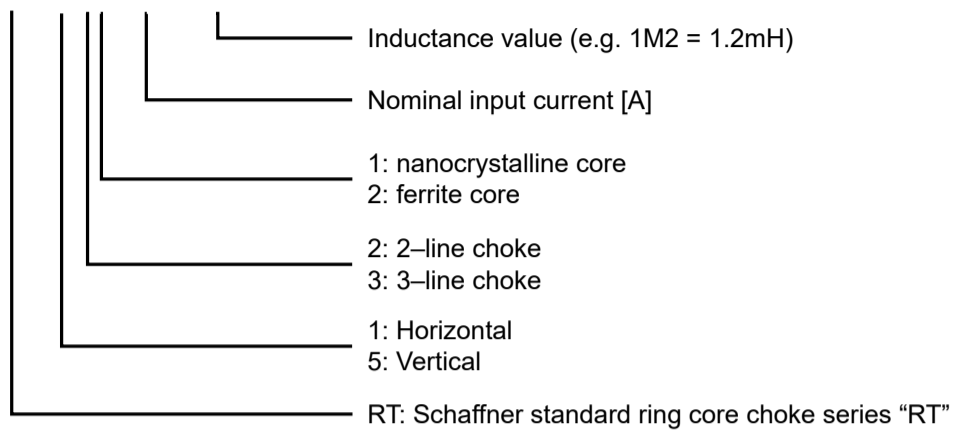

Examples: RT8532-16-3M0: Vertical 3-line choke for 16 A, with 3 mH ; RT8122-20-3M0: Horizontal 2-line choke for 20 A, with 3 mH

### Distribution Inventory

Up-to-date inventory levels for global distributors is available at

<https://products.schaffner.com/stock>



### Typical Choke Attenuation And Impedance - 2-Line Versions

Per CISPR 17; 50 Ω/50 Ω asym

RT8x22-6-10M

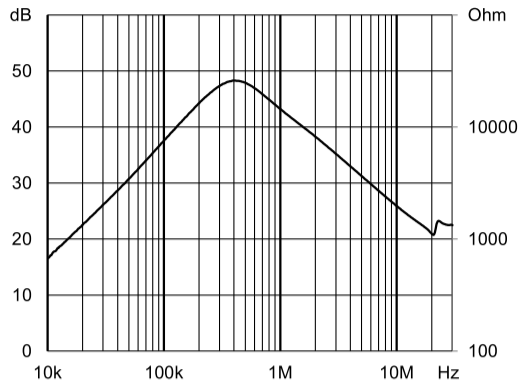

RT8x22-8-8M0

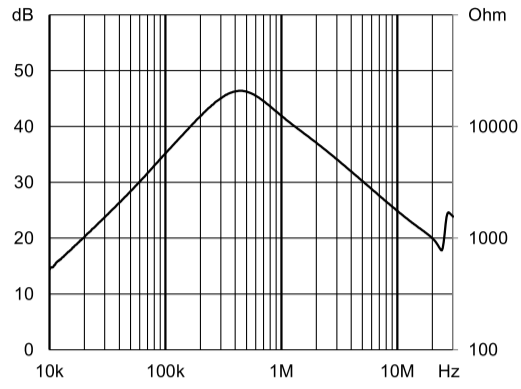

RT8x22-10-6M0

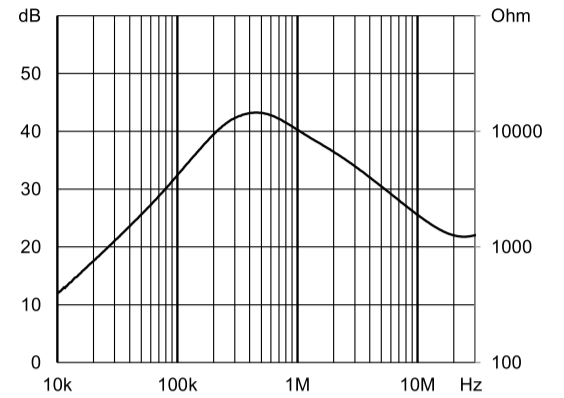

RT8x22-12-5M0

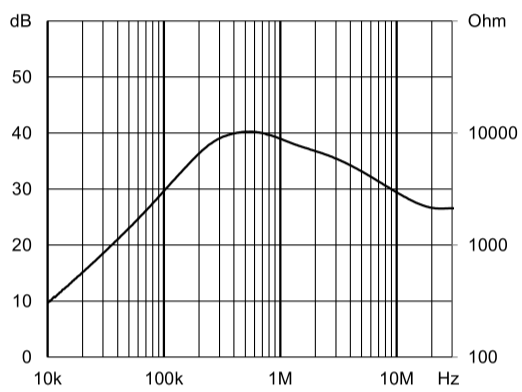

RT8122-16-4M0

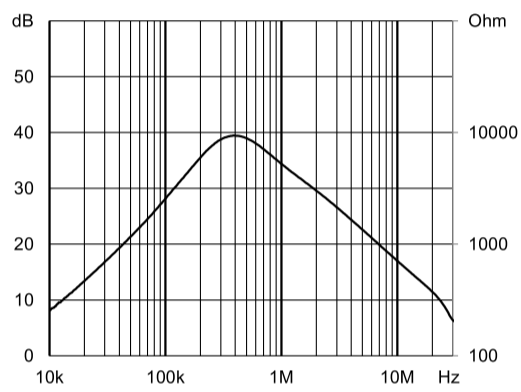

RT8122-20-3M0

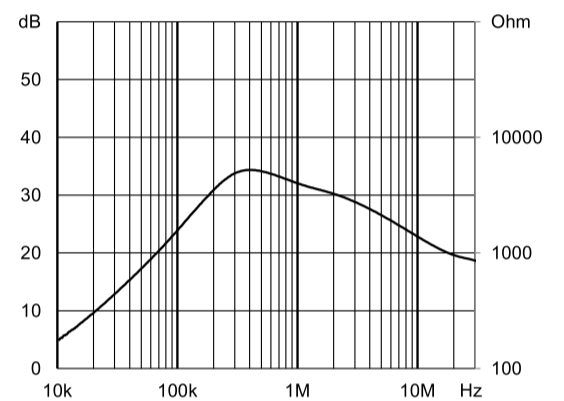

RT8x22-32-1M5

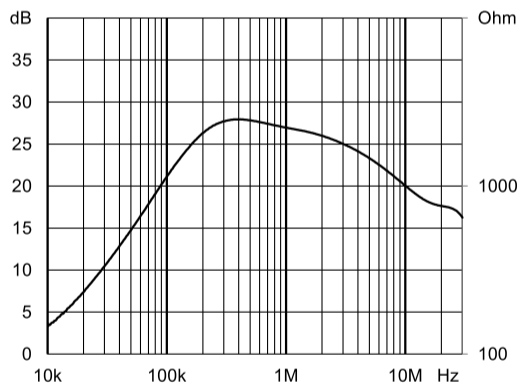

RT8x22-40-1M2

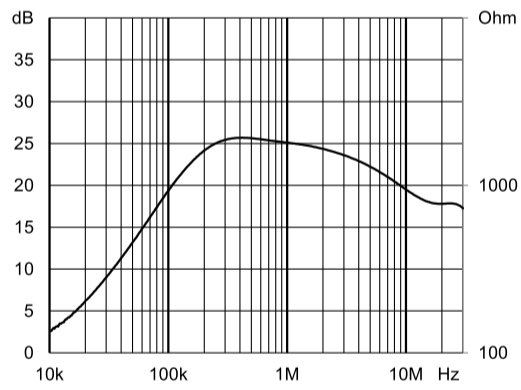

RT8x22-50-1M0

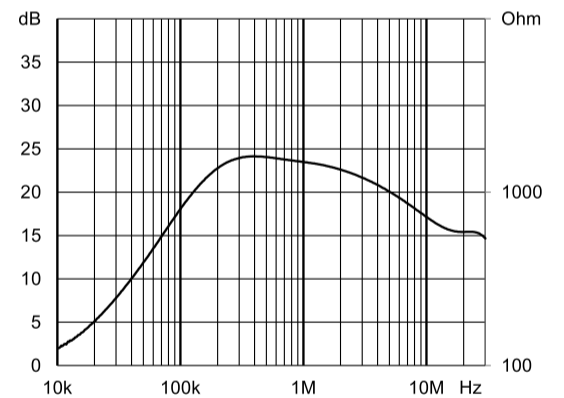

RT8x22-63-0M5

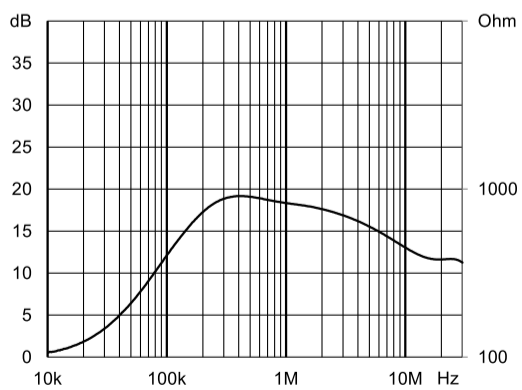

### Typical Choke Attenuation And Impedance - 3-Line Versions

Per CISPR 17; 50 Ω/50 Ω asym

RT8x32-6-6M0

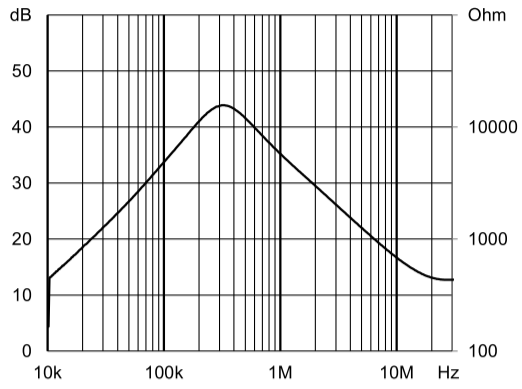

RT8x32-8-4M8

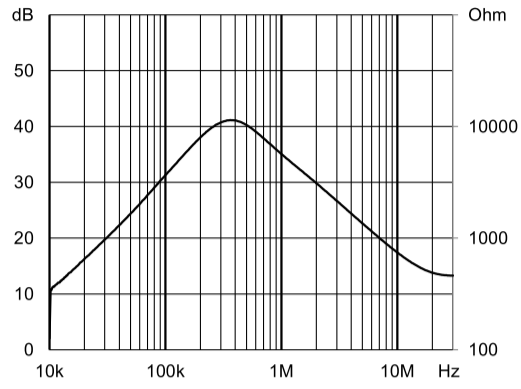

RT8x32-10-4M0

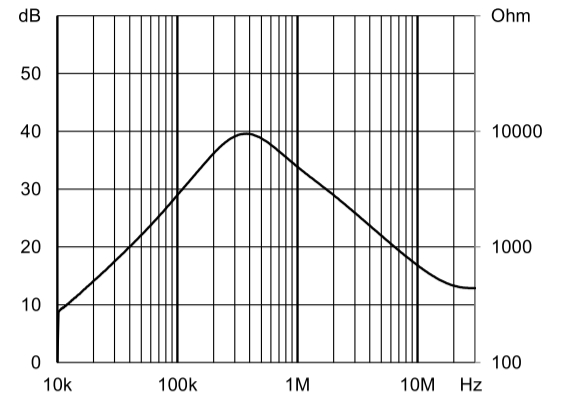

RT8x32-12-3M6

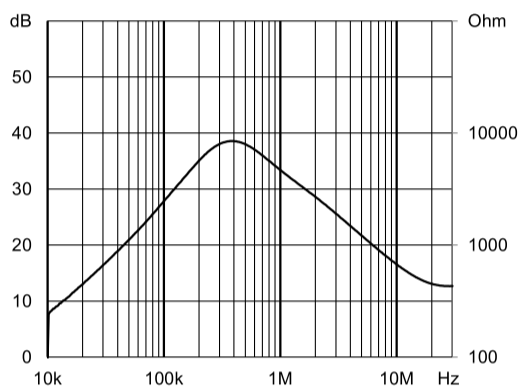

RT8x32-16-3M0

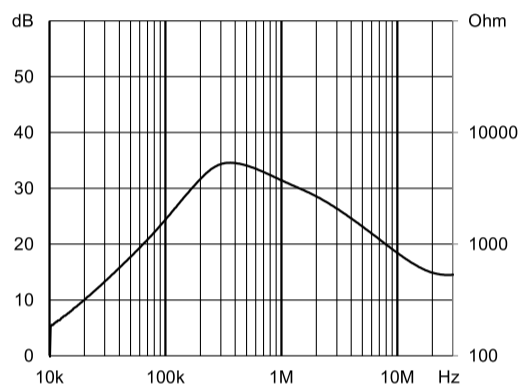

RT8x32-20-2M5

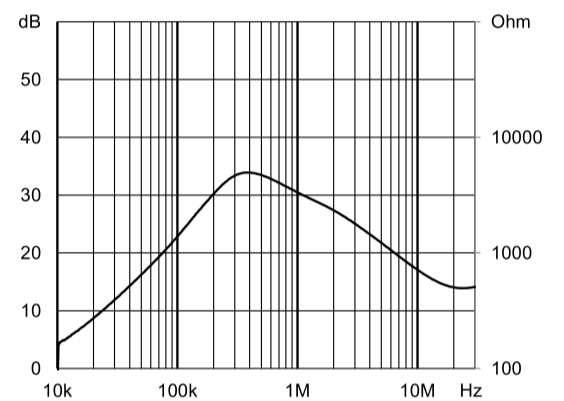

RT8x32-25-1M5

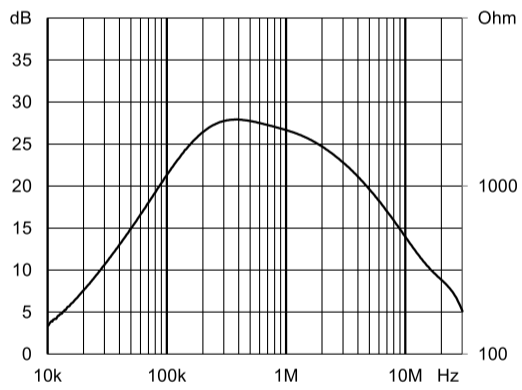

RT8x32-32-1M2

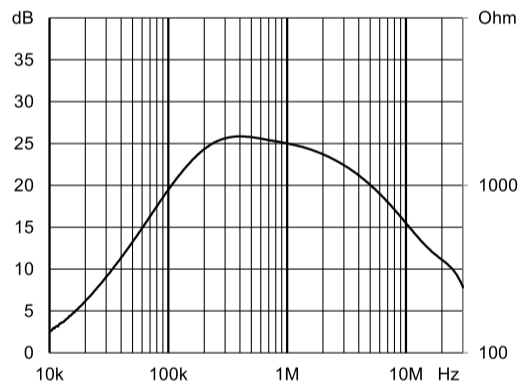

RT8x32-40-0M7

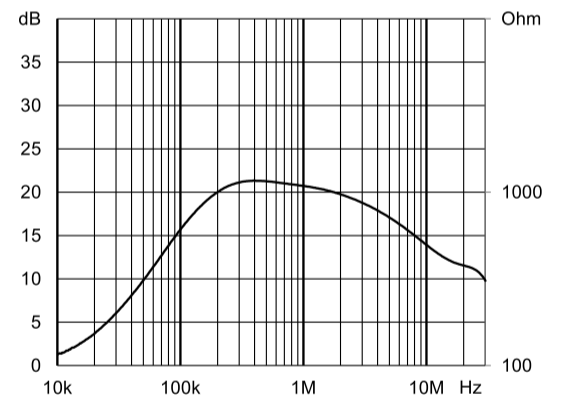

RT8x32-50-0M5

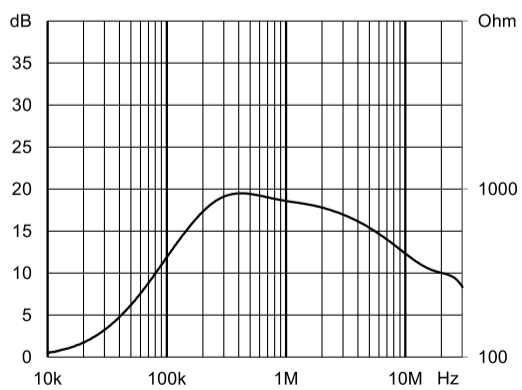

RT8x32-63-0M3

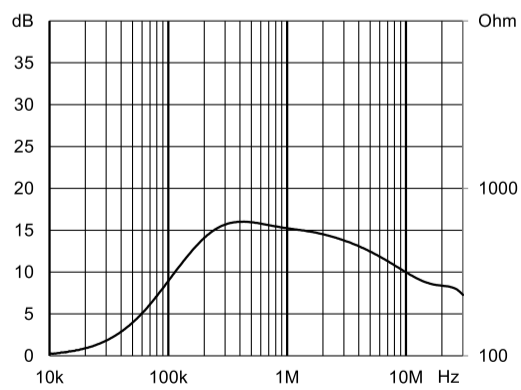

## Mechanical Data: Horizontal Chokes (2-line And 3-line Up To Size 12)

All dimensions in mm; 1 inch = 25.4 mm

Tolerances according: ISO 2768-m/EN 22768-m

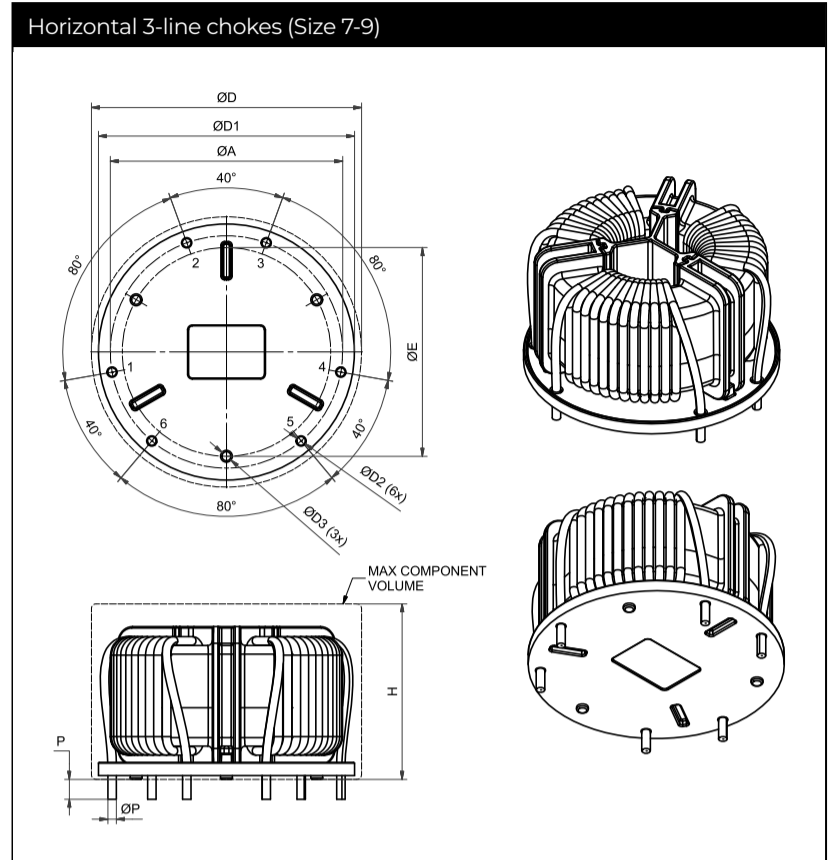
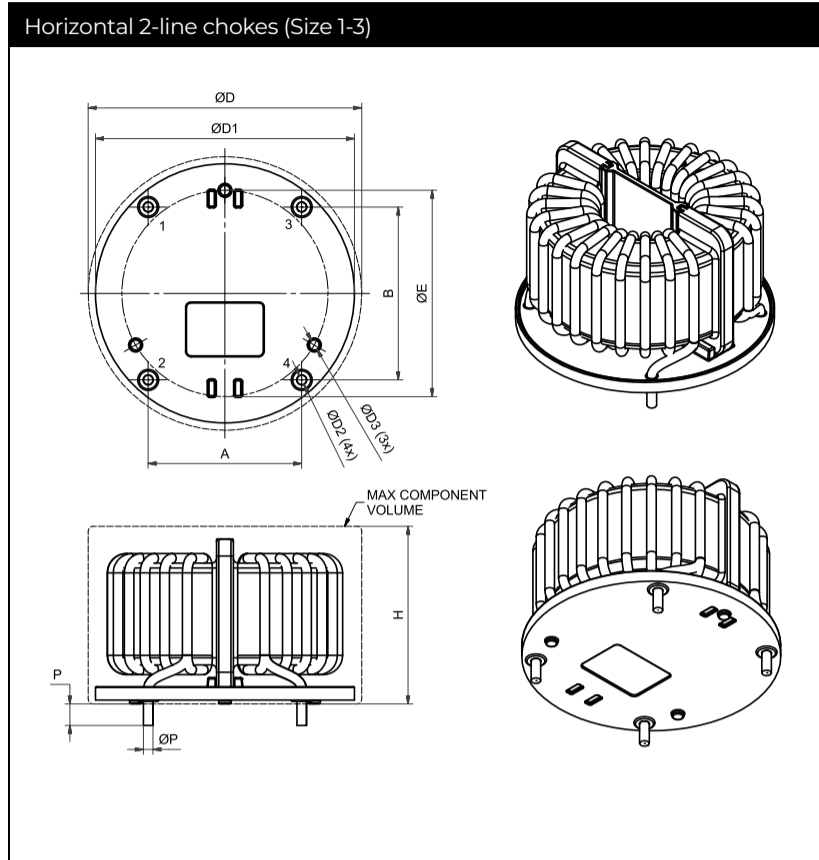

## Dimensions

	A	B	ØD	H	ØD1	ØD2	ØD3	ØE
	(±0.5)	(±0.5)	(max)	(max)	(±0.5)			
<b>Size1 (RT8122-6-10M0, RT8122-8-8M0, RT8122-10-6M0)</b>	21	25	45	34	42	1.5	2.5	36
<b>Size2 (RT8122-12-5M0, RT8122-16-4M0)</b>	26	30	51	33	48	1.9	2.5	40
<b>Size3 (RT8122-20-3M0)</b>	32	36	57	37	54	2.1	2.5	43
<b>Size 7 (RT8132-6-6M0, RT8132-8-4M8)</b>	38	-	46	34	43	1.4	2.5	35
<b>Size 8 (RT8132-10-4M0, RT8132-12-3M6)</b>	44	-	51	33	48	1.7	2.5	40
<b>Size 9 (RT8132-16-3M0, RT8132-20-2M5)</b>	49	-	57	37	54	2.3	2.5	44

Pin material: Copper (base), Sn (final plating typical thickness 0.15 mm; composition: Sn-1.2Ag-4Cu or SN-3Cu-0.25Ni)

Please visit [www.schaffner.com](http://www.schaffner.com) to find more details on filter connections.

### Mechanical Data: Vertical Chokes (2-line And 3-line Up To Size 12)

All dimensions in mm; 1 inch = 25.4 mm

Tolerances according: ISO 2768-m/EN 22768-m

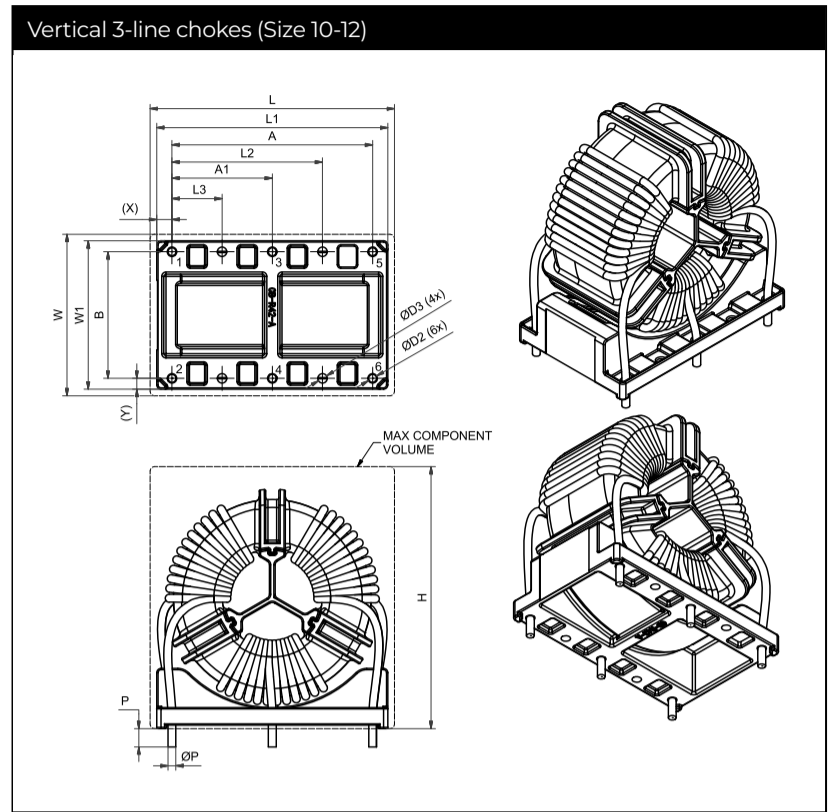
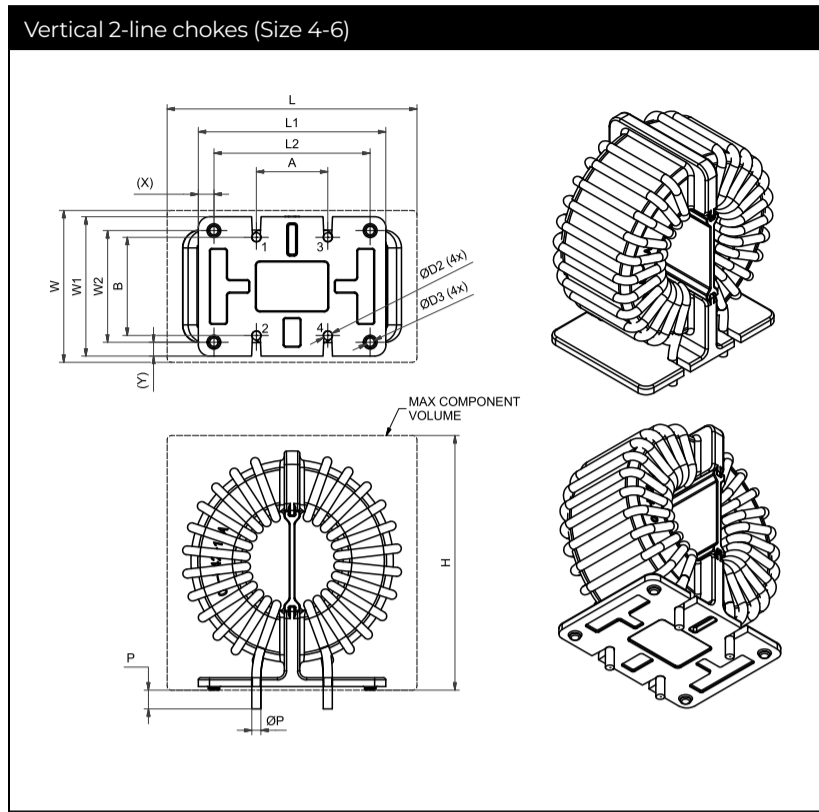

### Dimensions

	A	A1	B	L	W	H	L1	L2	L3	W1	W2	ØD2	ØD3	X	Y
	(±0.5)	(±0.5)	(±0.5)	(max)	(max)	(max)	(±0.5)	(±0.5)		(±0.5)	(±0.5)				
<b>Size 4 (RT8522-6-10M0, RT8522-8-8M0, RT 8522-10-6M0)</b>	16	-	20	43	32	44	32	26	-	27.8	22	1.5	2.5	3	2.9
<b>Size 5 (RT8522-12-5M0, RT8522-16-4M0)</b>	16	-	22	50	32	52	39	33	-	27	23	1.9	2.5	3	2
<b>Size 6 (RT8522-20-3M0)</b>	16	-	22	56	32	57	42	35	-	31.2	25	2.1	2.5	3.5	3.1
<b>Size 10 (RT8532-6-6M0, RT8532-8-4M8)</b>	36	18	24	44	32	47	41	27	9	29	-	1.4	1.4	2.5	2.5
<b>Size 11 (RT8532-10-4M0, RT8532-12-3M6)</b>	38	19	24	49	34	53	46	28.5	9.5	31	-	1.7	1.7	4	3.5
<b>Size 12 (RT8532-16-3M0, RT8532-20-2M5)</b>	46	23	29	56	37	60	53	34.5	11.5	34	-	2.2	2.2	3.5	2.5

Pin material: Copper (base), Sn (final plating typical thickness 0.15 mm; composition: Sn-1.2Ag-4Cu or SN-3Cu-0.25Ni)

Please visit [www.schaffner.com](http://www.schaffner.com) to find more details on filter connections.

### Mechanical Data: Vertical And Horizontal Chokes

All dimensions in mm; 1 inch = 25.4 mm

Tolerances according: ISO 2768-m/EN 22768-m

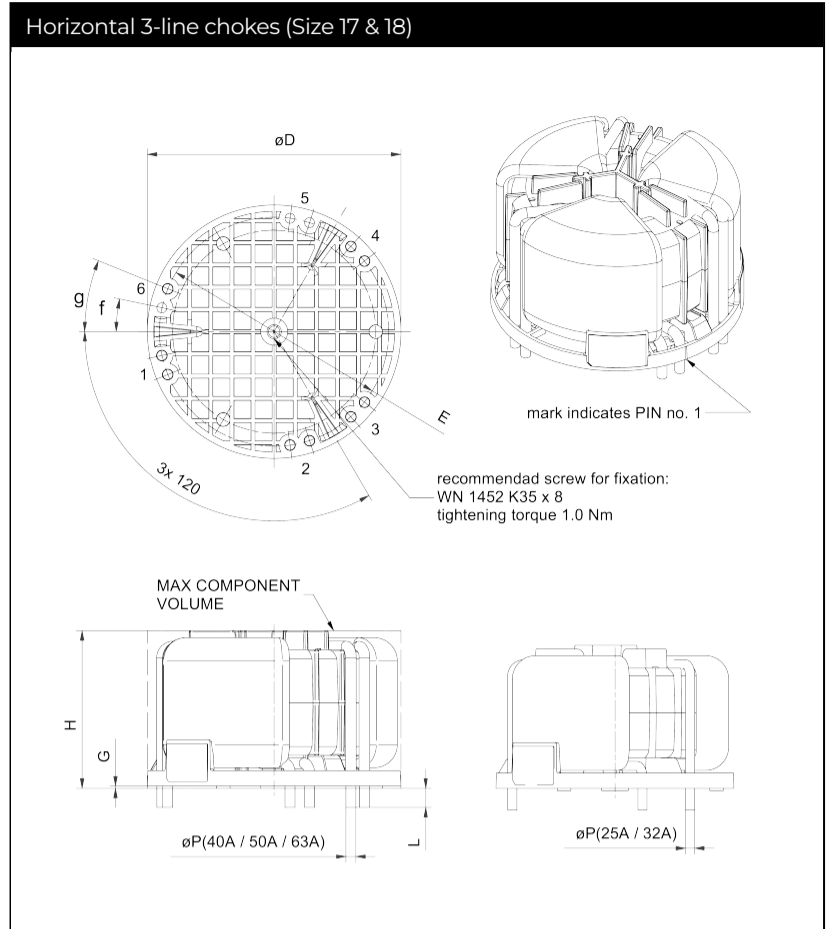
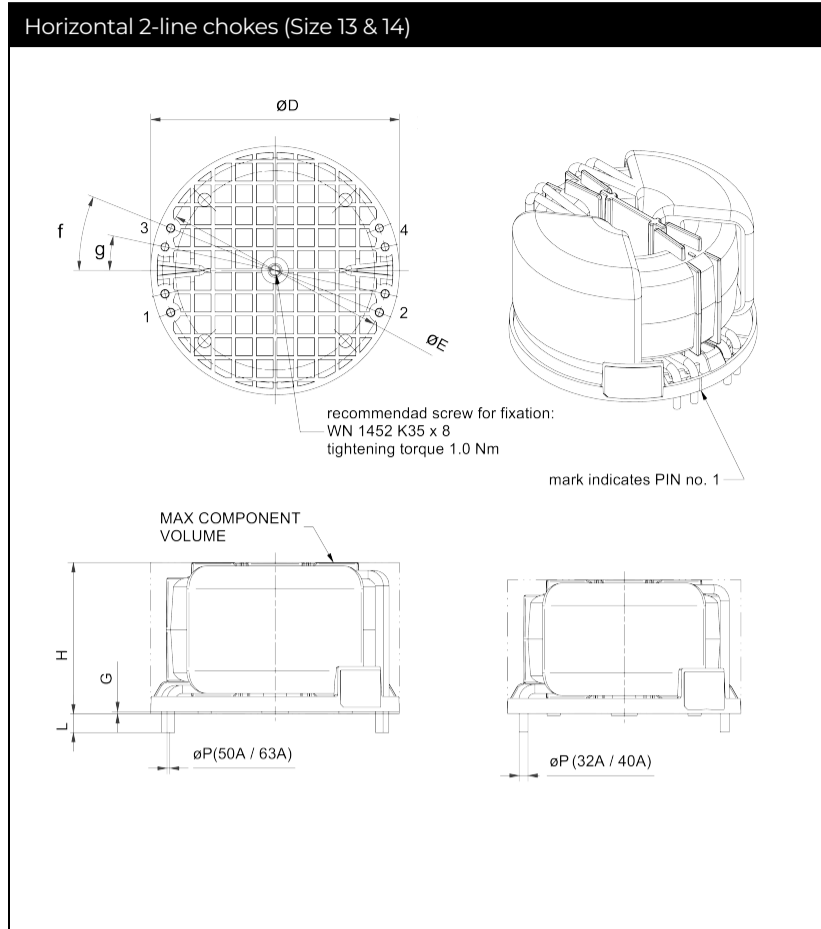

### Dimensions

	$\varnothing D$	H	G	$\varnothing E$	f	g	L	$\varnothing P$	$\varnothing P$	$\varnothing P$	$\varnothing P$	$\varnothing P$
								(25A)	(32A)	(40A)	(50A)	(63A)
	$\pm 0.2$	(max)	$\pm 0.1$	$\pm 0.2$	$\pm 1^\circ$	$\pm 1^\circ$	$\pm 0.5$	$\pm 0.1$	$\pm 0.1$	$\pm 0.1$	$\pm 0.1$	$\pm 0.1$
<b>Size 13 (RT8122-32-1M5, RT8122-40-1M2)</b>	62	37	0.6	55.4	150°		5		2.4	2.8		
<b>Size 14 (RT8122-50-1M0, RT8122-63-0M5)</b>	66	41	0.6	59.8	120°	220°	5				2.2	2.2
<b>Size 17 (RT8132-25-1M5, RT8132-32-1M2)</b>	62	38	0.6	55.4	150°		5	2.4	2.4			
<b>Size 18 (RT8132-40-0M7, RT8132-50-0M5, RT8132-63-0M3)</b>	66	42	0.6	59.8	120°	220°	5			1.9	2.2	2.6

### Mechanical Data: Vertical And Horizontal Chokes

All dimensions in mm; 1 inch = 25.4 mm

Tolerances according: ISO 2768-m/EN 22768-m

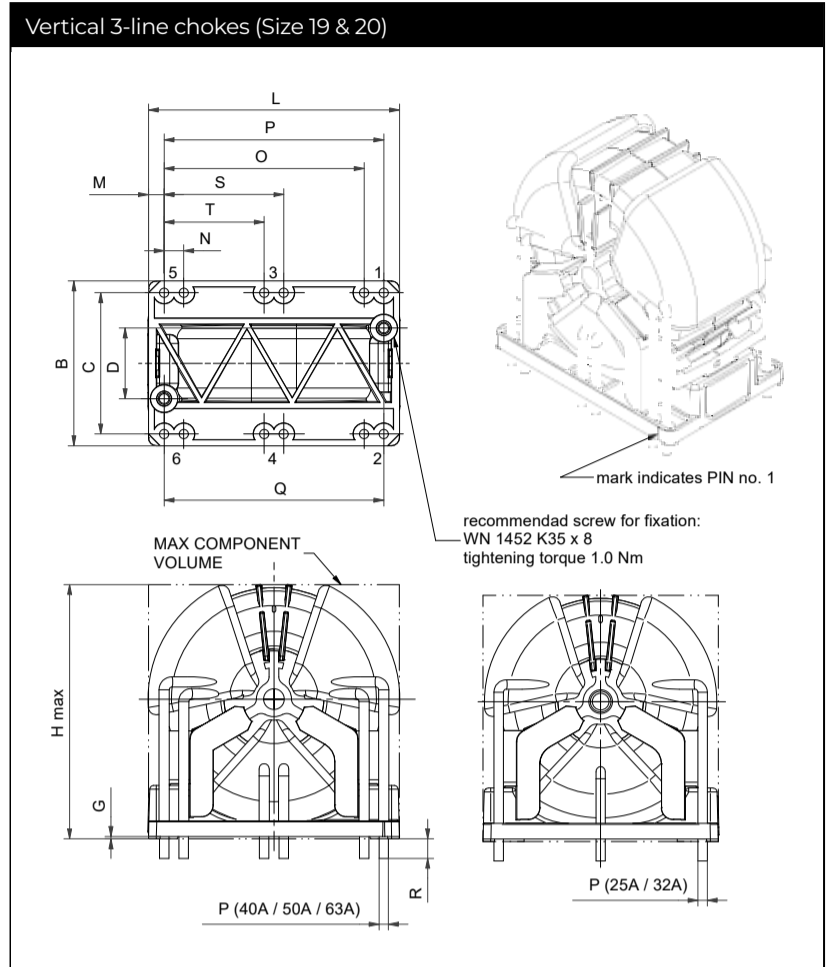
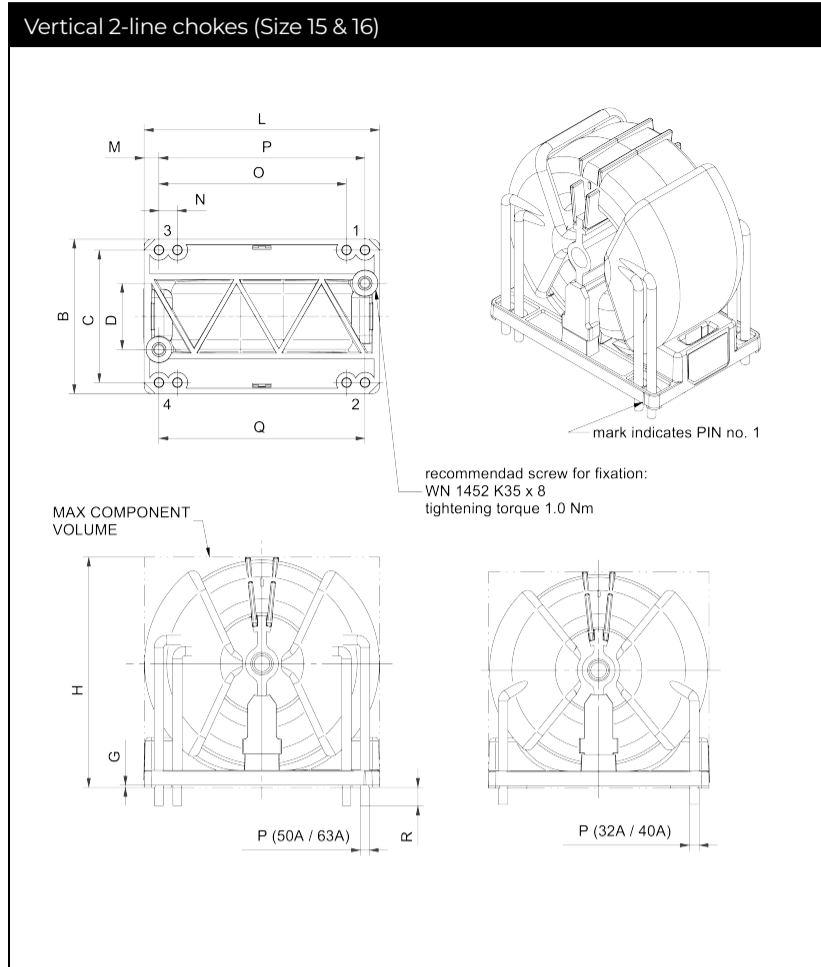

### Dimensions

1

	H	G	B	C	D	L	M	N	O	P	Q	S	T	R	øP	øP	øP	øP	øP
															(25A)	(32A)	(40A)	(50A)	(63A)
		±0.1	±0.2	±0.4	±0.2	±0.2	±0.1	±0.4	±0.4	±0.4	±0.4	±0.4	±0.2	±0.5	±0.1	±0.1	±0.1	±0.1	±0.1
<b>Size 15 (RT8522-32-1M5, RT8522-40-1M2)</b>	60	0.6	38	32	12	60	4			52	46			5		2.4	2.8		
<b>Size 16 (RT8522-50-1M0, RT8522-63-0M5)</b>	64	0.6	42	36	18	64	4	5	51	56	56			5				2.2	2.2
<b>Size 19 (RT8532-25-1M5, RT8532-32-1M2)</b>	63	0.6	38	32	12	60	4			52	46		26	5	2.4	2.4			
<b>Size 20 (RT8532-40-0M7, RT8532-50-0M5, RT8532-63-0M3)</b>	67	0.6	42	36	18	64	4	5	51	56	56	30.5	25.5	5			1.9	2.2	2.6

## Soldering Profile

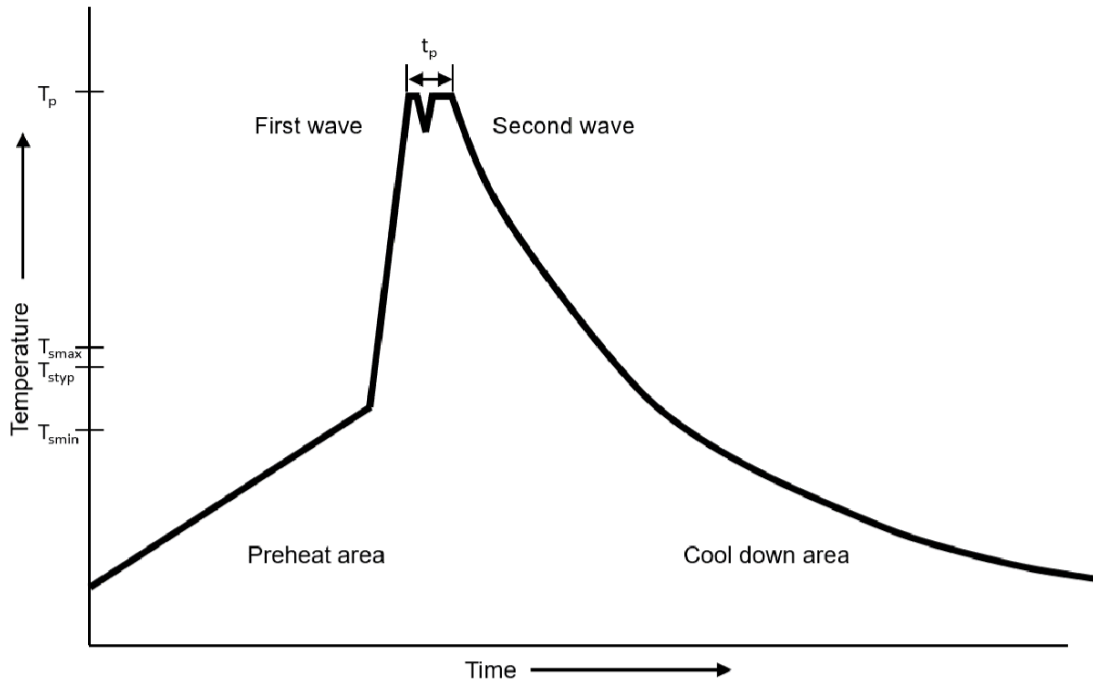

### Reference IEC61760-1:2020

Profile Feature	Lead (Pb) Free Solder
Preheat	Temperature min. ( $T_{smin}$ ) 100 °C
	Temperature typ. ( $T_{styp}$ ) 120 °C
	Temperature max. ( $T_{smax}$ ) 130 °C
	Time ( $T_{smin}$ to $T_{smax}$ )( $t_s$ ) 70 seconds
$\Delta$ Preheat to max Temperature	150 °C max.
Peak temperature ( $T_p$ )	250 °C – 260 °C
Time at peak temperature ( $t_p$ )	6 seconds max. 2 seconds each wave
Ramp-down rate	~ 2 K/s min. ~ 3.5 K/s typ. ~ 5 K/s max.
Time 25 °C to 25 °C	4 minutes

### Manual solder

350 °C  $\pm$  10 °C, 10 seconds  $\pm$  1s (by soldering iron).

## Headquarters, Global Innovation and Development

**Switzerland**  
**Schaffner Group**  
 Industrie Nord  
 Nordstrasse 11e  
 4542  
 Luterbach  
 +41 32 681 66 26  
[info@schaffner.com](mailto:info@schaffner.com)

## Sales and Application Centers

**Finland**  
**Schaffner Oy**  
 Lohjanharjuntie 1109  
 08500  
 Lohja  
 + 358 50 468 72 84  
[finlandsales@schaffner.com](mailto:finlandsales@schaffner.com)

**France**  
**Schaffner EMC S.A.S.**  
 16-20 Rue Louis Rameau  
 95875  
 Bezons  
 +33 1 34 34 30 60  
[francesales@schaffner.com](mailto:francesales@schaffner.com)

**Germany**  
**Schaffner Deutschland GmbH**  
 Ohiostr. 8  
 76149  
 Karlsruhe  
 +49 721 56910  
[germanysales@schaffner.com](mailto:germanysales@schaffner.com)

**Italy**  
**Schaffner EMC S.r.l.**  
 Via Ticino, 30  
 20900  
 Monza (MB)  
 +39 039 21 41 070  
[italysales@schaffner.com](mailto:italysales@schaffner.com)

**Japan**  
**Schaffner EMC K.K.**  
 ISM Sangenjaya 7F  
 1-32-12 Kamiyama Setagaya-ku  
 154-0011  
 Tokyo  
 +81 3 5712 3650  
[japansales@schaffner.com](mailto:japansales@schaffner.com)

**Singapore**  
**Schaffner EMC Pte Ltd.**  
 Blk 3015A Ubi Road 1 #05-09 Kampong Ubi  
 Industrial Estate  
 408705  
 Singapore  
 +65 63773283  
[singaporesales@schaffner.com](mailto:singaporesales@schaffner.com)

**Sweden**  
**Schaffner EMC AB**  
 Östermalmstrorg 1  
 114 42  
 Stockholm  
 +46 8 5050 2425  
[swedensales@schaffner.com](mailto:swedensales@schaffner.com)

**Switzerland**  
**Schaffner EMV AG**  
 Industrie Nord  
 Nordstrasse 11e  
 4542  
 Luterbach  
 +41 32 681 66 26  
[switzerlandsales@schaffner.com](mailto:switzerlandsales@schaffner.com)

**India**  
**Schaffner India Pvt. Ltd**  
 Regus World Trade Centre  
 WTC 22nd Floor Unit No 2238 Brigade  
 Gateway Campus 26/1 Dr. Rajkumar Road  
 Malleshwaram (W)  
 560055  
 Bangalore  
 +91 8067935355  
[indiasales@schaffner.com](mailto:indiasales@schaffner.com)

**United Kingdom**  
**Schaffner Ltd.**  
 Suite 1 Oakmede Place  
 Terrace Road  
 RG42 4JF  
 Binfield  
 +44 118 9770070  
[uksales@schaffner.com](mailto:uksales@schaffner.com)

**United States**  
**Schaffner EMC Inc.**  
 52 Mayfield Avenue  
 Edison, New Jersey  
 +1 732 225 9533  
[usasales@schaffner.com](mailto:usasales@schaffner.com)

To find your local partner within Schaffner's global network [schaffner.com](http://schaffner.com)

© 2024 Schaffner Group

The content of this document has been carefully checked and understood. However, neither Schaffner nor its subsidiaries assume any liability whatsoever for any errors or inaccuracies of this document and the consequences thereof. Published specifications are subject to change without notice. Product suitability for any area of application must ultimately be determined by the customer. In all cases, products must never be operated outside their published specifications. Schaffner does not guarantee the availability of all published products. This disclaimer shall be governed by substantive Swiss law and resulting disputes shall be settled by the courts at the place of business of Schaffner Holding AG. Latest publications and a complete disclaimer can be downloaded from the Schaffner website. All trademarks recognized.

## Looking for pricing, stock, or lifecycle information?

Click below to explore more details on WIN SOURCE:

[View RT8132-10-4M0 on WIN SOURCE](#)

[Schaffner EMC Inc. Information](#)

## Optimize Your Supply Chain with WIN SOURCE Solutions

- ✓ Global Sourcing Solution
- ✓ Obsolete Management
- ✓ Cost Control Management
- ✓ Shortage Management
- ✓ Alternative Solution
- ✓ Excess Inventory Management