



**THE DATASHEET OF  
C1206X5R100-107MNE**





**FEATURES:**

- Capacitance range: 0.1pF to 220uF
- Voltage range: 4V to 100V
- Terminations: 100% matte Tin (Sn), Palladium (Pd-Ag), Gold (Au) and Lead (Pb)
- Very low ESR in X7R/X7S/X6S/X5R (<10mΩ typical)
- Ceramic monolithic structure provides excellent reliability



**PART NUMBER STRUCTURE**

C	0805	COG	500	-	101	J	N	P	□ □															
<b>Series</b>	<b>Size</b>	<b>Temperature Characteristic (Dielectric)</b>	<b>Rated Voltage</b>		<b>Capacitance</b>	<b>Tolerance</b>	<b>Termination</b>	<b>Packaging</b>	<b>Optional Thickness Identifier</b>															
01005	0201	0402	0504	0603	0805	1206	1210	1812	2220	22212	COG	X7R	X7S	X6S	X5R	Y5V	Z5U	1st two digits are significant followed by number of zeroes.	4R0 = 4.0 VDCW 6R3 = 6.3 VDCW 100 = 10 VDCW 160 = 16 VDCW 250 = 25 VDCW 500 = 50 VDCW 630 = 63 VDCW 101 = 100 VDCW	1st two digits are significant, followed by number of zeroes. e.g: 101 = 100pF R denotes decimal 6R8 = 6.8pF	* B = ± 0.1pF * C = ± 0.25pF * D = ± 0.5pF F = ± 1% G = ± 2% J = ± 5% K = ± 10% M = ± 20% N = ± 30% Z = +80 - 20% * For values below 10pF only.	N = 100% matte Tin (Sn) over Nickel * P = Palladium Silver * G = Gold over Nickel Pb = 90% Tin (Sn) /10% Lead (Pb) * Pd/Ag & Gold terminations have limited values & sizes available.	D = Paper Tape (10" Reel) E = Embossed Tape (7" Reel) P = Paper Tape (7" Reel) R = Paper Tape (13" Reel) U = Embossed Tape (13" Reel)	Leave blank for standard thickness. Designate "-." for Min. "" for Max. followed by Thickness Code <b>e.g:</b> - E (min. thickness of .026") * E (max. thickness of .026")

Example P/N: C0805COG500-101JNP

**Optional Thickness Identifier Codes:**

CODE:	C	D	E	F	G	H	I	J	K	L	M	N	O	P	Q	R	S	T	U	V	6
DIMENSION:	.015	.020	.026	.030	.035	.040	.045	.050	.055	.060	.065	.070	.075	.080	.085	.090	.095	.100	.105	.110	.023

**DIMENSIONS**

Unit: inches (mm)

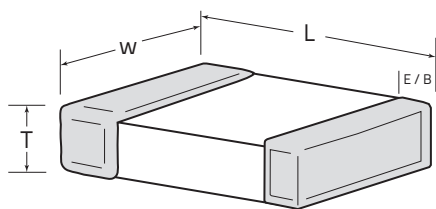

SIZE	L	W	T	MIN. E/B
01005	0.016 ± 0.0008 (0.4 ± 0.02)	0.008 ± 0.0008 (0.2 ± 0.02)	See Specific Value	0.002 (0.05)
0201	0.024 ± 0.002 (0.6 ± 0.05)	0.012 ± 0.002 (0.3 ± 0.05)	See Specific Value	0.002 (0.05)
0402*	0.040 ± 0.002 (1.0 ± 0.05)	0.020 ± 0.002 (0.5 ± 0.05)	See Specific Value	0.004 (0.10)
0603	0.063 ± 0.006 (1.6 ± 0.15)	0.031 ± 0.0046 (0.8 ± 0.15)	See Specific Value	0.008 (0.20)
0805	0.08 ± 0.008 (2.0 ± 0.20)	0.050 ± 0.008 (1.25 ± 0.20)	See Specific Value	0.010 (0.25)
1206	0.126 ± 0.008 (3.2 ± 0.20)	0.063 ± 0.008 (1.6 ± 0.20)	See Specific Value	0.010 (0.25)
1210	0.126 ± 0.0157 (3.2 ± 0.40)	0.098 ± 0.0118 (2.50 ± 0.30)	See Specific Value	0.010 (0.25)
1812	0.177 ± 0.012 (4.495 ± 0.30)	0.126 ± 0.012 (3.20 ± 0.30)	See Specific Value	0.010 (0.25)
2220	0.225 ± 0.016 (5.715 ± 0.41)	0.200 ± 0.006 (5.08 ± 0.41)	See Specific Value	0.010 (0.25)

\* 0402 size in the X6S/X7S/X5R dielectrics will have a dimensional tolerance of ±0.20mm

**STRUCTURE**

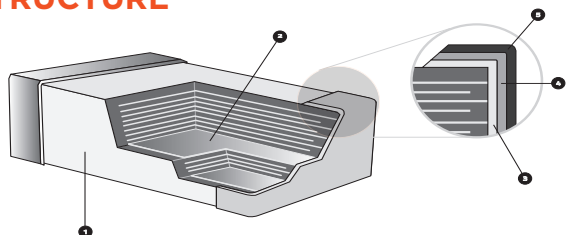

1	Ceramic Body (dielectric)	4	Nickel Plating
2	Inner Electrode	5	Tin Plating
3	Inner Termination		

## ELECTRICAL SPECIFICATIONS

### COG/COG

Typical Capacitance Change vs. Temperature

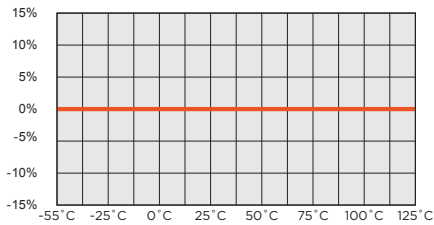

**Operating Temperature Range:**  
-55°C to +125°C  
**Temperature Coefficient:**  
0 ±30PPM/°C  
**Temperature Voltage Coefficient:**  
0 ±30PPM/°C  
**Insulation Resistance:**  
>1000 Ω-F or 10 GΩ, for values ≤ 0.047µF (whichever is less at 25°C, WDCV).  
For Capacitance values > 0.047µF, the 500 Ω-F rule applies. (The IR at 125°C is 10% of the value at 25°C)

**Ageing:**  
None  
**Withstanding Voltage:**  
>2.5 times VDCW  
**Capacitance Tolerance:**  
B,C,D,F,G,J,K  
**Dissipation Factor:**  
0.1% max

### X7R

Typical Capacitance Change vs. Temperature

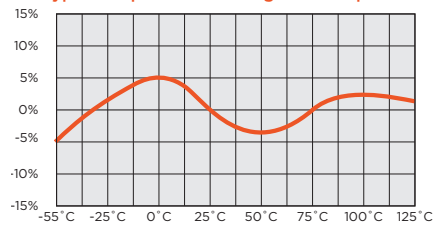

**Operating Temperature Range:**  
-55°C to +125°C  
**Temperature Coefficient:**  
0 ±15%Δ°C MAX.  
**Temperature Voltage Coefficient:**  
X7R not applicable  
**Insulation Resistance:**  
>100 Ω-F or 10 GΩ, whichever is less at 25°C, VDCW. (The IR at 125°C is 10% of the value at 25°C)  
**Ageing:**  
2.5% per decade hour, typical  
**Withstanding Voltage:**  
>2.5 times VDCW  
**Capacitance Tolerance:**  
J,K,M

RATED VOLTAGE	D.F.	EXCEPTION OF D.F.	
		≤3%	EXCEPTION OF D.F.
≥50V	≤2.5%	≤3%	0201 (50V); 0603≥0.047µF 0805≥0.22µF; 1206≥0.47µF
		≤5%	0603≥1µF; 0805≥1µF; 1206≥4.7µF; 1210≥4.7µF
25V	≤2.5%	≤5%	0201≥0.01µF; 0805≥1µF; 1210≥4.7µF
		≤10%	0402≥0.10µF; 0603≥0.33µF; 0805≥2.2µF 1206≥2.2µF; 1210≥22µF
16V	≤3.5%	≤5%	0201≥0.01µF; 0402≥0.033µF; 0805≥0.68µF; 1206≥2.2µF; 1210≥4.7µF
		≤10%	0402≥0.47µF; 0603≥0.68µF; 0805≥2.2µF; 1206≥4.7µF; 1210≥22µF
10V	≤5%	≤10%	0402≥0.33µF; 0603≥0.33µF; 0805≥2.2µF; 1206≥2.2µF; 1210≥22µF
6.3V	≤10%		

### X7S

Typical Capacitance Change vs. Temperature

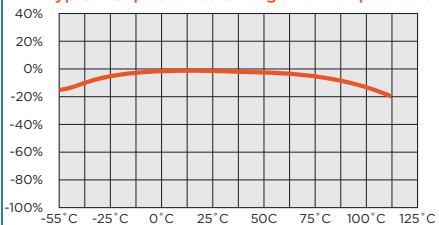

**Operating Temperature Range:**  
-55°C to +125°C  
**Temperature Coefficient:**  
0 ±22%Δ°C MAX.  
**Insulation Resistance:**  
>1000 Ω-F or 100 GΩ, whichever is less at 25°C, VDCW. (The IR at 125°C is 10% of the value at 25°C)  
**Ageing:**  
2.5% per decade hour, typical  
**Withstanding Voltage:**  
>2.5 times VDCW  
**Capacitance Tolerance:**  
K,M

RATED VOLTAGE	D.F.	EXCEPTION OF D.F.	
		≤3%	EXCEPTION OF D.F.
≥50V	≤2.5%	≤3%	0201 (50V); 0603≥0.047µF 0805≥0.22µF; 1206≥0.47µF
		≤5%	0603≥1µF; 0805≥1µF; 1206≥4.7µF; 1210≥4.7µF
25V	≤2.5%	≤5%	0201≥0.01µF; 0805≥1µF; 1210≥4.7µF
		≤10%	0402≥0.10µF; 0603≥0.33µF; 0805≥2.2µF 1206≥4.7µF; 1210≥22µF
16V	≤3.5%	≤5%	0201≥0.01µF; 0402≥0.033µF; 0805≥0.68µF; 1206≥2.2µF; 1210≥4.7µF
		≤10%	0402≥0.47µF; 0603≥0.68µF; 0805≥2.2µF; 1206≥4.7µF; 1210≥22µF
≤10V	≤5%	≤10%	0402≥0.33µF; 0603≥0.33µF; 0805≥2.2µF; 1206≥2.2µF; 1210≥22µF
6.3V	≤10%		

## ELECTRICAL SPECIFICATIONS

### X6S

Typical Capacitance Change vs. Temperature

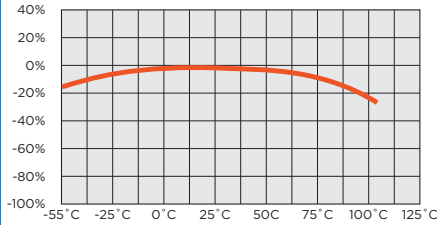

**Operating Temperature Range:**  
-55°C to +105°C  
**Temperature Coefficient:**  
0 ±22%Δ°C MAX.  
**Insulation Resistance:**  
100,000 MΩ min., or 1000 MΩ (@ +25°C, RVDC) per uF min. or 100GW, whichever is less  
**Ageing:**  
2.5% per decade hour, typical  
**Withstanding Voltage:**  
>2.5 times VDCW  
**Capacitance Tolerance:**  
K,M

RATED VOLTAGE	D.F.	EXCEPTION OF D.F.	
≥50V	≤2.5%	≤3%	0201 (50V); 0603≥0.047uF 0805≥0.22uF; 1206≥0.47uF
		≤5%	0603≥1uF; 0805≥1uF; 1206≥4.7uF; 1210≥4.7uF
25V	≤2.5%	≤5%	0201≥0.01uF; 0805≥1uF; 1210≥4.7uF
		≤10%	0402≥0.10uF; 0603≥0.33uF; 0805≥2.2uF 1206≥4.7uF; 1210≥22uF
16V	≤3.5%	≤5%	0201≥0.01uF; 0402≥0.033uF; 0805≥0.68uF; 1206≥2.2uF; 1210≥4.7uF
		≤10%	0402≥0.47uF; 0603≥0.68uF; 0805≥2.2uF; 1206≥4.7uF; 1210≥22uF
≤10V	≤5%	≤10%	0402≥0.33uF; 0603≥0.33uF; 0805≥2.2uF; 1206≥2.2uF; 1210≥22uF
4V/6.3V	≤10%	≤15%	0402≥10uF

### X5R

Typical Capacitance Change vs. Temperature

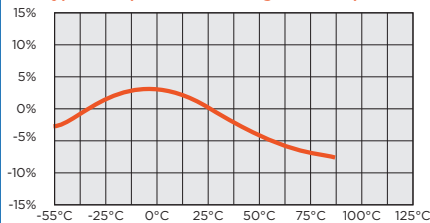

**Operating Temperature Range:**  
-55°C to +85°C  
**Temperature Coefficient:**  
0 ±15%Δ°C MAX.  
**Insulation Resistance:**  
>100 Ω-F or 10 GΩ, whichever is less at 25°C, VDCW. (The IR at 125°C is 10% of the value at 25°C)  
**Ageing:**  
2.5% per decade hour, typical  
**Withstanding Voltage:**  
>2.5 times VDCW  
**Capacitance Tolerance:**  
K,M

RATED VOLTAGE	D.F.	EXCEPTION OF D.F.	
≥50V	≤2.5%	≤3%	0201 (50V); 0603≥0.047uF 0805≥0.22uF; 1206≥0.47uF
		≤5%	0603≥1uF; 0805≥1uF; 1206≥4.7uF; 1210≥4.7uF
25V	≤2.5%	≤5%	0201≥0.01uF; 0805≥1uF; 1210≥4.7uF
		≤10%	0402≥0.10uF; 0603≥0.33uF; 0805≥2.2uF 1206≥4.7uF; 1210≥22uF
16V	≤3.5%	≤5%	0201≥0.01uF; 0402≥0.033uF; 0805≥0.68uF; 1206≥2.2uF; 1210≥4.7uF
		≤10%	0402≥0.47uF; 0603≥0.68uF; 0805≥2.2uF; 1206≥4.7uF; 1210≥22uF
≤10V	≤5%	≤10%	0402≥0.33uF; 0603≥0.33uF; 0805≥2.2uF; 1206≥2.2uF; 1210≥22uF
6.3V	≤10%		

### Z5U

Typical Capacitance Change vs. Temperature

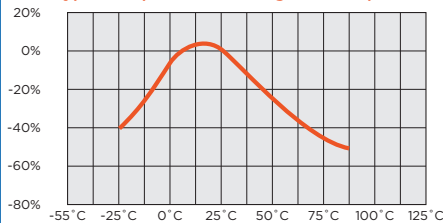

**Operating Temperature Range:**  
+10°C to +85°C  
**Temperature Coefficient:**  
+22% - 56%Δ°C MAX.  
**Insulation Resistance:**  
>100 Ω-F or 10 GΩ, whichever is less at 25°C, VDCV. (The IR at 125°C is 10% of the value at 25°C)  
**Ageing:**  
5% per decade hour, typical  
**Withstanding Voltage:**  
>2.5 times VDCW  
**Capacitance Tolerance:**  
M,Z

RATED VOLTAGE	D.F.	EXCEPTION OF D.F.	
≥50V	≤5%	≤9%	0603≥0.1uF; 0805≥0.47uF; 1206≥4.7uF;
25V	≤5%	≤9%	0402≥0.047uF; 0603≥0.1uF; 0805≥0.33uF; 1206≥1uF; 1210≥4.7uF
		≤12.5%	0603≥2.2uF; 0805≥3.3uF; 1206≥10uF; 1210≥22uF; 1812≥47uF
16V	≤9%	≤16%	0603≥2.2uF; 0805≥3.3uF; 1206≥4.7uF; 1210≥10uF; 1812≥47uF
6.3V	≤16%		

### Y5V

Typical Capacitance Change vs. Temperature

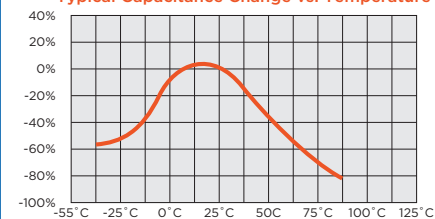

**Operating Temperature Range:**  
-30°C to +85°C  
**Temperature Coefficient:**  
+22% - 82%Δ°C MAX.  
**Insulation Resistance:**  
>100 Ω-F or 10 GΩ, whichever is less at 25°C, VDCW. (The IR at 125°C is 10% of the value at 25°C)  
**Ageing:**  
7% per decade hour, typical  
**Withstanding Voltage:**  
>2.5 times VDCW  
**Capacitance Tolerance:**  
M,Z

RATED VOLTAGE	D.F.	EXCEPTION OF D.F.	
≥50V	≤5%	≤9%	0603≥0.1uF; 0805≥0.47uF; 1206≥4.7uF;
25V	≤5%	≤9%	0402≥0.047uF; 0603≥0.1uF; 0805≥0.33uF; ≥1206≥1uF; 1210≥4.7uF
		≤12.5%	0603≥2.2uF; 0805≥3.3uF; 1206≥10uF; 1210≥22uF; 1812≥47uF
16V	≤9%	≤16%	0603≥2.2uF; 0805≥3.3uF; 1206≥4.7uF; 1210≥10uF; 1812≥47uF
6.3V	≤16%		

**TEST PARAMETERS**

Test parameters for Multilayer Ceramic Capacitors  
- X7R, X7S, X6S, X5R and Y5V:

1KHz ± 100Hz at 1.0 ± 0.2 Vrms < 10uF (10 V min.)  
1KHz ± 100Hz at 1.0 ± 0.1 Vrms < 10uF (6.3V max.)  
120Hz ± 24Hz at 1.0 ± 0.1 Vrms ≥ 10uF

Test parameters for Multilayer Ceramic Capacitors  
- COG:

1MHz ± 100KHz at 1.0 ± 0.2 Vrms ≤ 1000pF, 25°C  
1KHz ± 100Hz at 1.0 ± 0.2 Vrms > 1000pF, 25°C

**NOTE:** To ensure proper capacitance readings, the voltage level must be held constant. The HP4284 and Agilent E4980 has a "ALC" (Automatic Level Control) function and should be switched to the "ON" position for accurate capacitance readings.

**VOLTAGE AND CAPACITANCE RANGE**

**COG (COG) DIELECTRIC**

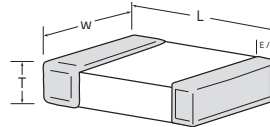

Values that are typically available.

(All measurements in inches)

SIZE	01005				0201		0402			0504		0603		0805			1206		1210		1812	
T (max)	0.008				0.012		0.025			0.040		0.033		0.055			0.075		0.103		0.110	
VDCW (MAX)	6.3V	16V	25V	50V	25V	50V	25V	50V	100V	50V	100V	50V	100V	25V	50V	100V	50V	100V	50V	100V	50V	100V
OR1	0.1pF																					
OR2	0.2pF																					
OR3	0.3pF																					
OR4	0.4pF																					
OR5	0.5pF																					
1R0	1.0pF																					
1R2	1.2pF																					
1R5	1.5pF																					
1R8	1.8pF																					
2R2	2.2pF																					
2R7	2.7pF																					
3R3	3.3pF																					
3R9	3.9pF																					
4R7	4.7pF																					
5R0	5.0pF																					
5R6	5.6pF																					
6R8	6.8pF																					
8R2	8.2pF																					
100	10pF																					
120	12pF																					
150	15pF																					
180	18pF																					
220	22pF																					

**NOTE:** Additional values may be available. Please contact us for more information. Due to demand and raw material fluctuations, specific values may not be available.

**VOLTAGE AND CAPACITANCE RANGE**

**COG (COG) DIELECTRIC**

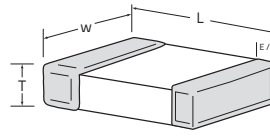

Values that are typically available.

(All measurements in inches)

SIZE		01005				0201		0402			0504		0603		0805			1206		1210		1812		2220 / 2221		
T (max)		0.008				0.012		0.025			0.040		0.033		0.055			0.075		0.103		0.110		0.134 / 0.134		
VDCW (MAX)		6.3V	16V	25V	50V	25V	50V	25V	50V	100V	50V	100V	50V	100V	25V	50V	100V	50V	100V	50V	100V	50V	100V	50V	100V	
270	27pF																									
330	33pF																									
390	39pF																									
470	47pF																									
560	56pF																									
680	68pF																									
820	82pF																									
101	100pF																									
121	120pF																									
151	150pF																									
181	180pF																									
221	220pF																									
271	270pF																									
331	330pF																									
391	390pF																									
471	470pF																									
561	560pF																									
681	680pF																									
821	820pF																									
102	1000pF																									
122	1200pF																									
152	1500pF																									
182	1800pF																									
222	2200pF																									
272	2700pF																									
332	3300pF																									
392	3900pF																									
472	4700pF																									
562	5600pF																									
682	6800pF																									
822	8200pF																									
103	.01uF																									
123	.012uF																									
153	.015uF																									
183	.018uF																									
223	.022uF																									
273	.027uF																									
333	.033uF																									
393	.039uF																									
473	.047uF																									
563	.056uF																									
683	.068uF																									
823	.082uF																									
104	.100uF																									
124	.120uF																									
154	.150uF																									
184	.180uF																									
224	.220uF																									
274	.270uF																									
334	.330uF																									
394	.390uF																									
474	.470uF																									
564	.560uF																									
684	.680uF																									
824	.820uF																									

NOTE: Additional values may be available. Please contact us for more information. Due to demand and raw material fluctuations, specific values may not be available.

## VOLTAGE AND CAPACITANCE RANGE

### X7R DIELECTRIC

Values that are typically available.

(All measurements in inches)

SIZE		01005		0201				0402				0504			0603					0805			
T (max)		0.008		0.012				0.025				0.040			0.038					0.058			
VDCW (MAX)		6.3V	10V	6.3V	10V	16V	25V	16V	25V	50V	100V	25V	50V	100V	10V	16V	25V	50V	100V	25V	50V	100V	
101	100pF																						
121	120pF																						
151	150pF																						
181	180pF																						
221	220pF																						
271	270pF																						
331	330pF																						
391	390pF																						
471	470pF																						
561	560pF																						
681	680pF																						
821	820pF																						
102	1000pF																						
122	1200pF																						
152	1500pF																						
182	1800pF																						
222	2200pF																						
272	2700pF																						
332	3300pF																						
392	3900pF																						
472	4700pF																						
562	5600pF																						
682	6800pF																						
822	8200pF																						
103	.01uF																						
123	.012uF																						
153	.015uF																						
183	.018uF																						
223	.022uF																						
273	.027uF																						
333	.033uF																						

\* For values above 1uF, thickness may be greater than specified above.

T(max): 0603 - 0.040"

0805 - 0.060"

**NOTE:** Additional values may be available. Please contact us for more information. Due to demand and raw material fluctuations, specific values may not be available. All components manufactured with the X7R dielectric are also available as an X5R dielectric.

## VOLTAGE AND CAPACITANCE RANGE

### X7R DIELECTRIC

Values that are typically available.

(All measurements in inches)

SIZE	0201			0402					0603					0805						
T (max)*	0.012			0.025					0.038					0.059						
VDCW (MAX)	4V	6.3V	10V	6.3V	10V	16V	25V	50V	6.3V	10V	16V	25V	50V	100V	6.3V	10V	16V	25V	50V	100V
393																				
473																				
563																				
683																				
823																				
104	**	**	**																	
124																				
154																				
184																				
224																				
274																				
334																				
394																				
474																				
564																				
684																				
824																				
105																				
125																				
155																				
185																				
225																				
335																				
475																				
685																				
106																				
156																				35V
226																				
476																				
107																				

\* For values above 1uF, thickness may be greater than specified above.

T(max): 0603 - 0.040"  
 0805 - 0.060"

**NOTE:** Additional values may be available. Please contact us for more information. Due to demand and raw material fluctuations, specific values may not be available. All components manufactured with the X7R dielectric are also available as an X5R dielectric.

\*\* RE: 0201, X7R, 0.1uF; When the operating temperature range is between 100°C and 125°C, it is recommended to apply the following voltage derating as shown in the diagram below.

### DERATING CURVE FOR 0201, 0.1UF, X7R ONLY

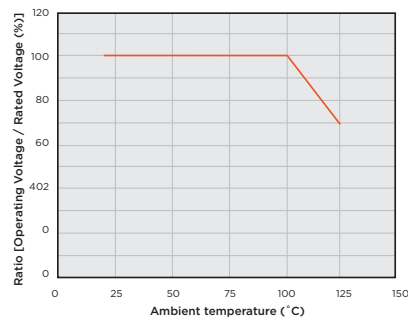

**VOLTAGE AND CAPACITANCE RANGE**

**X7R DIELECTRIC**

Values that are typically available.

(All measurements in inches)

SIZE		1206					1210					1812					2220 / 2221				
T (max)*		0.070					0.125					0.085					0.108 / 0.108				
VDCW (MAX)		10V	16V	25V	50V	100V	10V	16V	25V	50V	100V	6.3V	10V	16V	25V	50V	100V	16V	25V	50V	100V
102	1000pF																				
122	1200pF																				
152	1500pF																				
182	1800pF																				
222	2200pF																				
272	2700pF																				
332	3300pF																				
392	3900pF																				
472	4700pF																				
562	5600pF																				
682	6800pF																				
822	8200pF																				
103	.01uF																				
123	.012uF																				
153	.015uF																				
183	.018uF																				
223	.022uF																				
273	.027uF																				
333	.033uF																				
393	.039uF																				
473	.047uF																				
563	.056uF																				
683	.068uF																				
823	.082uF																				
104	.100uF																				
124	.120uF																				
154	.150uF																				
184	.180uF																				
224	.220uF																				
274	.270uF																				
334	.330uF																				

\* For values above 1uF, thickness may be greater than specified above.

T(max): 0603 - 0.040"  
 0805 - 0.060"

**NOTE:** Additional values may be available. Please contact us for more information. Due to demand and raw material fluctuations, specific values may not be available. All components manufactured with the X7R dielectric are also available as an X5R dielectric.



VOLTAGE AND CAPACITANCE RANGE

X7S DIELECTRIC (0201-0805)

Values that are typically available.

(All measurements in inches)

SIZE		0201				0402					0603					0805						
T (max)*		0.012				0.025					0.038					0.059						
VDCW (MAX)		4V	6.3V	10V	16V	6.3V	10V	16V	25V	50V	6.3V	10V	16V	25V	50V	6.3V	10V	16V	25V	50V		
CAPACITANCE CODE	104	CAPACITANCE VALUE	0.10uF																			
	224		0.22uF																			
	474		0.47uF																			
	105		1.00uF																			
	225		2.2uF																			
	475		4.7uF																			
	106		10.0uF																			
	226		22.0uF																			
	476		47.0uF																			
	107		100.0uF																			

X7S DIELECTRIC (1206-2220)

(All measurements in inches)

SIZE		1206					1210					1812				2220				
T (max)*		0.080					0.125					0.095				0.108				
VDCW (MAX)		6.3V	10V	16V	25V	50V	6.3V	10V	16V	25V	50V	16V	25V	50V	100V	16V	25V	50V	100V	
CAPACITANCE CODE	104	CAPACITANCE VALUE	0.10uF																	
	224		0.22uF																	
	474		0.47																	
	105		1.00uF																	
	225		2.2uF																	
	335		3.3uF																	
	475		4.7uF																	
	106		10.0uF																	
	156		15.0uF																	
	226		22.0uF																	
476	47.0uF																			
107	100.0uF																			

\* For values above 1uF, thickness may be greater than specified above.

T(max): 0603 - 0.040"  
0805 - 0.060"

NOTE: Additional values may be available. Please contact us for more information. Due to demand and raw material fluctuations, specific values may not be available. All components manufactured with the X7R dielectric are also available as an X5R dielectric.

## VOLTAGE AND CAPACITANCE RANGE

### X6S DIELECTRIC (0201-0805)

Values that are typically available.

(All measurements in inches)

SIZE		0201				0402					0603					0805								
T (max)*		0.012				0.025					0.038					0.059								
VDCW (MAX)		4V	6.3V	10V	16V	6.3V	10V	16V	25V	50V	4V	6.3V	10V	16V	25V	50V	4V	6.3V	10V	16V	25V	50V		
CAPACITANCE CODE	104	CAPACITANCE VALUE	0.10uF																					
	224		0.22uF																					
	474		0.47uF																					
	105		1.00uF																					
	225		2.2uF																					
	475		4.7uF																					
	106		10.0uF																					
	226		22.0uF																					
	476		47.0uF																					
	107		100.0uF																					

### X6S DIELECTRIC (1206-2220)

(All measurements in inches)

SIZE		1206					1210					1812				2220				
T (max)*		0.080					0.125					0.095				0.108				
VDCW (MAX)		6.3V	10V	16V	25V	50V	6.3V	10V	16V	25V	50V	16V	25V	50V	100V	16V	25V	50V	100V	
CAPACITANCE CODE	104	CAPACITANCE VALUE	0.10uF																	
	224		0.22uF																	
	474		0.47uF																	
	105		1.00uF																	
	225		2.2uF																	
	335		3.3uF																	
	475		4.7uF																	
	106		10.0uF																	
	156		15.0uF																	
	226		22.0uF																	
476	47.0uF																			
107	100.0uF																			

\* For values above 1uF, thickness may be greater than specified above.

T(max): 0603 - 0.040"

0805 - 0.060"

**NOTE:** Additional values may be available. Please contact us for more information. Due to demand and raw material fluctuations, specific values may not be available. All components manufactured with the X7R dielectric are also available as an X5R dielectric.

## VOLTAGE AND CAPACITANCE RANGE

### X5R DIELECTRIC

Values that are typically available.

(All measurements in inches)

SIZE		01005		0201				0402					0603					0805					1206				1210		1812				
T (max)		0.008		0.0216				0.025					0.040					0.060					0.072				0.125		0.130				
VDCW (MAX)		6.3V	10V	4V	6.3V	10V	16V	25V	4V	6.3V	10V	16V	25V	50V	6.3V	10V	16V	25V	35V	50V	6.3V	10V	16V	25V	50V	6.3V	10V	16V	25V	16V	25V	16V	25V
102	1000pF																																
122	1200pF																																
152	1500pF																																
182	1800pF																																
222	2200pF																																
272	2700pF																																
332	3300pF																																
392	3900pF																																
472	4700pF																																
562	5600pF																																
682	6800pF																																
822	8200pF																																
103	.01uF																																
153	.015uF																																
223	.022uF																																
333	.033uF																																
393	.039uF																																
473	.047uF																																
104	0.10uF																																
154	.150uF																																
224	.220uF																																
334	.330uF																																
474	.470uF																																
684	.680uF																																
105	1.00uF																																
125	1.20uF																																
155	1.50uF																																
185	1.80uF																																
225	2.20uF																																
335	3.30uF																																

\* For values above 1uF, thickness may be greater than specified above.

T(max): 1206 - 0.075"      1812 - 0.130"  
 1210 - 0.125"      2220 - 0.135"

**NOTE:** Additional values may be available. Please contact us for more information. Due to demand and raw material fluctuations, specific values may not be available.  
 All components manufactured with the X7R dielectric are also available as an X5R dielectric.

## VOLTAGE AND CAPACITANCE RANGE

### X5R DIELECTRIC (0402-1206)

Values that are typically available.

(All measurements in inches)

SIZE		0201			0402				0603					0805					1206							
T (max)		0.0216			0.0335				0.040					0.060					0.072							
VDCW (MAX)		4V	6.3V	10V	4V	6.3V	10V	16V	4V	6.3V	10V	16V	25V	4V	6.3V	10V	16V	25V	35V	50V	6.3V	10V	16V	25V	50V	
CAPACITANCE CODE	395	3.90uF																								
	475	4.70uF																								
	685	6.80uF																								
	106	10.0uF																								
	156	15.0uF																								
	226	22.0uF																								
	476	47.0uF																								
	107	100.0uF																								
	157	150.0uF																								
	227	220.0uF																								

### X5R DIELECTRIC (1210-2221)

(All measurements in inches)

SIZE		1210					1812				2220 / 2221					
T (max)		0.125					0.130				0.135					
VDCW (MAX)		6.3V	10V	16V	25V	50V	6.3V	10V	16V	25V	6.3V	10V	16V	25V	50V	
CAPACITANCE CODE	395	3.90uF														
	475	4.70uF														
	685	6.80uF														
	106	10.0uF														
	156	15.0uF														
	226	22.0uF														
	476	47.0uF														
	107	100.0uF														
	157	150.0uF														
	227	220.0uF														

\* For values above 1uF, thickness may be greater than specified above.

T(max): 1206 - 0.075"      1812 - 0.130"  
 1210 - 0.125"      2220 - 0.135"

**NOTE:** Additional values may be available. Please contact us for more information. Due to demand and raw material fluctuations, specific values may not be available.  
 All components manufactured with the X7R dielectric are also available as an X5R dielectric.

## VOLTAGE AND CAPACITANCE RANGE

### Z5U DIELECTRIC

Values that are typically available.

(All measurements in inches)

SIZE		0504		0603		0805		1206		1210		1812		2220 / 2221	
T (max)		0.040		0.038		0.058		0.070		0.075		0.085		0.108 / 0.108	
VDCW (MAX)		25V	50V	25V	50V	25V	50V	25V	50V	25V	50V	25V	50V	25V	50V
102	1000pF														
122	1200pF														
152	1500pF														
182	1800pF														
222	2200pF														
272	2700pF														
332	3300pF														
392	3900pF														
472	4700pF														
562	5600pF														
682	6800pF														
822	8200pF														
103	.01uF														
123	.012uF														
153	.015uF														
183	.018uF														
223	.022uF														
273	.027uF														
333	.033uF														
393	.039uF														
473	.047uF														
563	.056uF														
683	.068uF														
823	.082uF														
104	.100uF														
124	.120uF														
154	.150uF														
184	.180uF														
224	.220uF														
274	.270uF														
334	.330uF														

**NOTE:** Additional values may be available. Please contact us for more information. Due to demand and raw material fluctuations, specific values may not be available.

## VOLTAGE AND CAPACITANCE RANGE

### Z5U DIELECTRIC

Values that are typically available.

(All measurements in inches)

SIZE		0504		0603		0805		1206		1210		1812		2220 / 2221	
T (max)		0.040		0.038		0.058		0.070		0.075		0.085		0.108 / 0.108	
VDCW (MAX)		25V	50V	25V	50V	25V	50V	25V	50V	25V	50V	25V	50V	25V	50V
CAPACITANCE CODE	394	.390uF													
	474	.470uF													
	564	.560uF													
	684	.680uF													
	824	.820uF													
	105	1.00uF													
	125	1.20uF													
	155	1.50uF													
	185	1.80uF													
	225	2.20uF													
	335	3.30uF													
	395	3.90uF													
	475	4.70uF													
	685	6.80uF													
	106	10.0uF													
	156	15.0uF													
	226	22.0uF													
	476	47.0uF													
107	100.0uF														

**NOTE:** Additional values may be available. Please contact us for more information. Due to demand and raw material fluctuations, specific values may not be available.  
 For values above 1uF, thickness may be greater than specified above.

**VOLTAGE AND CAPACITANCE RANGE**

**Y5V DIELECTRIC**

Values that are typically available.

(All measurements in inches)

SIZE		0201			0402			0603			0805			1206			1210			1812										
T (max)		0.012			0.025			0.038			0.058			0.070			0.096			0.085										
VDCW (MAX)		10V	6.3V	10V	16V	25V	50V	6.3V	10V	16V	25V	50V	6.3V	10V	16V	25V	50V	10V	16V	25V	50V	6.3V	10V	16V	25V	6.3V	10V	25V		
CAPACITANCE CODE	102	1000pF																												
	122	1200pF																												
	152	1500pF																												
	182	1800pF																												
	222	2200pF																												
	272	2700pF																												
	332	3300pF																												
	392	3900pF																												
	472	4700pF																												
	562	5600pF																												
	682	6800pF																												
	822	8200pF																												
	103	.01uF																												
	123	.012uF																												
	153	.015uF																												
	183	.018uF																												
	223	.022uF																												
	273	.027uF																												
	333	.033uF																												
	393	.039uF																												
	473	.047uF																												
	563	.056uF																												
	683	.068uF																												
	823	.082uF																												
	104	.100uF																												
	124	.120uF																												
	154	.150uF																												
	184	.180uF																												
	224	.220uF																												
	274	.270uF																												
	334	.330uF																												

**NOTE:** Additional values may be available. Please contact us for more information. Due to demand and raw material fluctuations, specific values may not be available. For values above 1uF, thickness may be greater than specified above.

## VOLTAGE AND CAPACITANCE RANGE

### Y5V DIELECTRIC

Values that are typically available.

(All measurements in inches)

SIZE		0201			0402			0603					0805					1206				1210					1812																									
T (max)		0.012			0.025			0.038					0.058					0.070				0.10					0.085																									
VDCW (MAX)		10V			6.3V			10V			16V			6.3V			10V			16V			25V			50V			6.3V			10V			16V			25V			50V			6.3V			10V			25V		
CAPACITANCE CODE	394	.390uF																																																		
	474	.470uF																																																		
	564	.560uF																																																		
	684	.680uF																																																		
	824	.820uF																																																		
	105	1.00uF																																																		
	125	1.20uF																																																		
	155	1.50uF																																																		
	185	1.80uF																																																		
	225	2.20uF																																																		
	335	3.30uF																																																		
	395	3.90uF																																																		
	475	4.70uF																																																		
	685	6.80uF																																																		
	106	10.0uF																																																		
	156	15.0uF																																																		
	226	22.0uF																																																		
	476	47.0uF																																																		
	107	100.0uF																																																		

**NOTE:** Additional values may be available. Please contact us for more information. Due to demand and raw material fluctuations, specific values may not be available.  
 For values above 1uF, thickness may be greater than specified above.

**TAPE & REEL SPECIFICATIONS**

All tape and reel specifications must be adhered to per EIA-481-1-A.

**REEL**

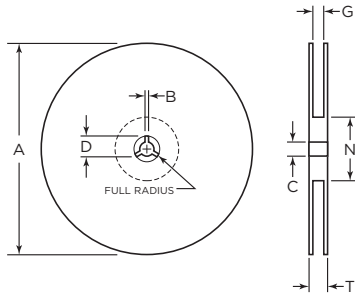

Unit: mm (inch)

Tape	B min	C	A (7")	A (13")	D min	N min	G	T max
4mm	2.0 (0.079)	13 ± 0.05 (0.512 ± 0.02)	178 ± 2.0 (7 ± 0.079)	-	21 ± 0.8 (0.82 ± 0.03)	50 (1.97)	5.0 ± 1.5 (0.196 ± 0.05)	8.0 max (0.315 max)
8mm	2.0 (0.07)	13 ± 0.05 (0.512 ± 0.02)	178 ± 2.0 (7 ± 0.079)	330 ± 2.0 (13 ± 0.08)	20.2 (0.795)	50 (1.97)	10 ± 1.5 (0.394 ± 0.059)	14.9 (0.587)
12mm	2.0 (0.07)	13 ± 0.05 (0.512 ± 0.02)	178 ± 2.0 (7 ± 0.079)	330 ± 2.0 (13 ± 0.08)	20.2 (0.795)	50 (1.97)	10 ± 1.5 (0.394 ± 0.059)	14.9 (0.587)

**TAPE**

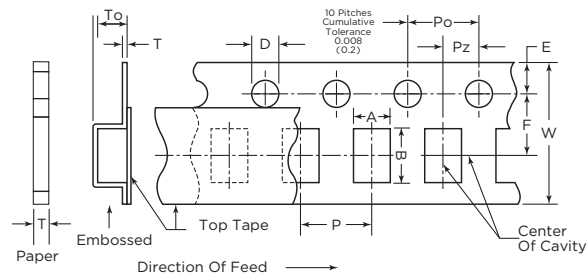

**7" Reel Quantities \*\***

SIZE	01005 (E)	01005 (P)	0201	0402	0603	0805	1206	1210	1812	2221
Tape Size	4mm	8mm	8mm	8mm	8mm	8mm	8mm	8mm	12mm	12mm
Min Qty Per Reel	40,000*	20000*	15,000	5,000	3,000	2,000	2,000	1,000	1,000	1,000
Max Qty Per Reel	40,000*	20000*	15,000	10,000	4,000	5,000	5,000	5,000	3,000	1,000

NOTE: \*\* Quantity dependent on thickness  
 \*Smaller quantities may be available. Please contact us.

**Paper Tape Carrier Dimensions (8mm)**

Unit: mm (inch)

Size (inches)	A	B	W	F	E	Po	Pz	D	t	P
01005	$\frac{0.25 \pm 0.05}{(0.010 \pm 0.002)}$	$\frac{0.45 \pm 0.05}{(0.018 \pm 0.002)}$	$\frac{8.0 \pm 0.2}{(0.315 \pm 0.008)}$	$\frac{3.5 \pm 0.1}{(0.138 \pm 0.004)}$	$\frac{1.75 \pm 0.1}{(0.069 \pm 0.004)}$	$\frac{4.0 \pm 0.1}{(0.157 \pm 0.004)}$	$\frac{2.0 \pm 0.05}{-0.0}$ $\frac{-0.0}{(0.039 \pm 0.002)}$ $-0.000$	$\frac{1.5 \pm 0.1}{(0.064 \pm .004)}$	$\frac{1.15 \text{ max}}{(0.045 \text{ max})}$	$\frac{2.0 \pm 0.05}{(0.079 \pm 0.002)}$
0201	$\frac{0.37 \pm 0.05}{(0.014 \pm 0.002)}$	$\frac{0.67 \pm 0.05}{(0.026 \pm 0.002)}$	$\frac{8.0 \pm 0.2}{(0.315 \pm 0.008)}$	$\frac{3.5 \pm 0.1}{(0.138 \pm 0.004)}$	$\frac{1.75 \pm 0.1}{(0.069 \pm 0.004)}$	$\frac{4.0 \pm 0.1}{(0.157 \pm 0.004)}$	$\frac{2.0 \pm 0.05}{-0.0}$ $\frac{-0.0}{(0.039 \pm 0.002)}$ $-0.000$	$\frac{1.5 \pm 0.1}{(0.064 \pm .004)}$	$\frac{1.15 \text{ max}}{(0.045 \text{ max})}$	$\frac{2.0 \pm 0.05}{(0.079 \pm 0.002)}$
0402	$\frac{0.65 \pm 0.1}{(0.026 \pm 0.004)}$	$\frac{1.10 \pm 0.2}{(0.043 \pm 0.008)}$	$\frac{8.0 \pm 0.2}{(0.315 \pm 0.008)}$	$\frac{3.5 \pm 0.1}{(0.138 \pm 0.004)}$	$\frac{1.75 \pm 0.1}{(0.069 \pm 0.004)}$	$\frac{4.0 \pm 0.1}{(0.157 \pm 0.004)}$	$\frac{2.0 \pm 0.05}{-0.0}$ $\frac{-0.0}{(0.039 \pm 0.002)}$ $-0.000$	$\frac{1.5 \pm 0.1}{(0.064 \pm .004)}$	$\frac{1.15 \text{ max}}{(0.045 \text{ max})}$	$\frac{2.0 \pm 0.05}{(0.079 \pm 0.002)}$
0603	$\frac{1.10 \pm 0.2}{(0.043 \pm 0.008)}$	$\frac{1.90 \pm 0.2}{(0.075 \pm 0.008)}$	$\frac{8.0 \pm 0.2}{(0.315 \pm 0.008)}$	$\frac{3.5 \pm 0.1}{(0.138 \pm 0.004)}$	$\frac{1.75 \pm 0.1}{(0.069 \pm 0.004)}$	$\frac{4.0 \pm 0.1}{(0.157 \pm 0.004)}$	$\frac{2.0 \pm 0.05}{-0.0}$ $\frac{-0.0}{(0.039 \pm 0.002)}$ $-0.000$	$\frac{1.5 \pm 0.1}{(0.064 \pm .004)}$	$\frac{1.15 \text{ max}}{(0.045 \text{ max})}$	$\frac{4.0 \pm 0.1}{(0.157 \pm 0.004)}$
0805	$\frac{1.16 \pm 0.2}{(0.046 \pm 0.008)}$	$\frac{2.4 \pm 0.2}{(0.095 \pm 0.008)}$	$\frac{8.0 \pm 0.2}{(0.315 \pm 0.008)}$	$\frac{3.5 \pm 0.1}{(0.138 \pm 0.004)}$	$\frac{1.75 \pm 0.1}{(0.069 \pm 0.004)}$	$\frac{4.0 \pm 0.1}{(0.157 \pm 0.004)}$	$\frac{2.0 \pm 0.05}{-0.0}$ $\frac{-0.0}{(0.039 \pm 0.002)}$ $-0.000$	$\frac{1.5 \pm 0.1}{(0.064 \pm .004)}$	$\frac{1.15 \text{ max}}{(0.045 \text{ max})}$	$\frac{4.0 \pm 0.1}{(0.157 \pm 0.004)}$
1206	$\frac{2.0 \pm 0.2}{(0.079 \pm 0.008)}$	$\frac{3.6 \pm 0.2}{(0.142 \pm 0.008)}$	$\frac{8.0 \pm 0.2}{(0.315 \pm 0.008)}$	$\frac{3.5 \pm 0.1}{(0.138 \pm 0.004)}$	$\frac{1.75 \pm 0.1}{(0.069 \pm 0.004)}$	$\frac{4.0 \pm 0.1}{(0.157 \pm 0.004)}$	$\frac{2.0 \pm 0.05}{-0.0}$ $\frac{-0.0}{(0.039 \pm 0.002)}$ $-0.000$	$\frac{1.5 \pm 0.1}{(0.064 \pm .004)}$	$\frac{1.15 \text{ max}}{(0.045 \text{ max})}$	$\frac{4.0 \pm 0.1}{(0.157 \pm 0.004)}$

**Embossed Carrier Dimensions (4mm, 8mm & 12mm)**

Size (inches)	A	B	W	F	E	Po	Pz	D	To	T	P
01005	$\frac{0.23}{(0.009)}$	$\frac{0.43}{(0.016)}$	$\frac{4.0 \pm 0.05}{(0.157 \pm 0.002)}$	$\frac{1.8 \pm 0.02}{(0.070 \pm 0.001)}$	$\frac{0.9 \pm 0.05}{(0.035 \pm 0.002)}$	$\frac{2.0 \pm 0.04}{(0.079 \pm 0.001)}$	$\frac{2.00}{(0.079)}$	$\frac{0.8 \pm 0.04}{(0.031 \pm 0.001)}$	$\frac{0.5 \text{ max}}{(0.019 \text{ max})}$	$\frac{0.15 - 0.4}{(0.005 - 0.015)}$	$\frac{1.00}{(0.039)}$
0603	$\frac{1.05 \pm 0.15}{(0.042 \pm 0.006)}$	$\frac{1.90 \pm 0.15}{(0.075 \pm 0.006)}$	$\frac{8.0 \pm 0.3}{(0.315 \pm 0.012)}$	$\frac{3.5 \pm 0.1}{(0.138 \pm .004)}$	$\frac{1.75 \pm 0.1}{(0.069 \pm .004)}$	$\frac{4.0 \pm 0.1}{(0.157 \pm .004)}$	$\frac{2.0 \pm 0.05}{(0.079 \pm .002)}$	$\frac{1.5 \pm 0.1}{-0.0}$ $\frac{-0.0}{(0.06 \pm .004)}$ $-0.000$	$\frac{0.75 \text{ max}}{(0.03 \text{ max})}$	$\frac{0.6 \text{ max}}{(0.024 \text{ max})}$	$\frac{4.0 \pm 0.1}{(0.157 \pm 0.004)}$
0805	$\frac{1.48 \pm 0.2}{(0.058 \pm 0.008)}$	$\frac{2.3 \pm 0.3}{(0.091 \pm .008)}$	$\frac{8.0 \pm 0.3}{(0.315 \pm 0.008)}$	$\frac{3.5 \pm 0.1}{(0.138 \pm 0.004)}$	$\frac{1.75 \pm 0.1}{(0.069 \pm 0.004)}$	$\frac{4.0 \pm 0.1}{(0.157 \pm 0.004)}$	$\frac{2.0 \pm 0.05}{(0.079 \pm 0.002)}$	$\frac{1.5 \pm 0.1}{-0.0}$ $\frac{-0.0}{(0.06 \pm 0.004)}$ $-0.000$	$\frac{2.5 \text{ max}}{(0.098 \text{ max})}$	$\frac{0.6 \text{ max}}{(0.024 \text{ max})}$	$\frac{4.0 \pm 0.1}{(0.157 \pm 0.004)}$
1206	$\frac{2.0 \pm 0.2}{(0.079 \pm 0.008)}$	$\frac{3.6 \pm 0.3}{(0.142 \pm 0.008)}$	$\frac{8.0 \pm 0.3}{(0.315 \pm 0.008)}$	$\frac{3.5 \pm 0.1}{(0.138 \pm 0.004)}$	$\frac{1.75 \pm 0.1}{(0.069 \pm 0.004)}$	$\frac{4.0 \pm 0.1}{(0.157 \pm 0.004)}$	$\frac{2.0 \pm 0.05}{(0.079 \pm 0.002)}$	$\frac{1.5 \pm 0.1}{-0.0}$ $\frac{-0.0}{(0.06 \pm 0.004)}$ $-0.000$	$\frac{2.5 \text{ max}}{(0.098 \text{ max})}$	$\frac{0.6 \text{ max}}{(0.024 \text{ max})}$	$\frac{4.0 \pm 0.1}{(0.157 \pm 0.004)}$
1210	$\frac{2.9 \pm 0.2}{(0.114 \pm 0.008)}$	$\frac{3.6 \pm 0.3}{(0.142 \pm 0.008)}$	$\frac{8.0 \pm 0.3}{(0.315 \pm 0.008)}$	$\frac{3.5 \pm 0.1}{(0.138 \pm 0.004)}$	$\frac{1.75 \pm 0.1}{(0.069 \pm 0.004)}$	$\frac{4.0 \pm 0.1}{(0.157 \pm 0.004)}$	$\frac{2.0 \pm 0.05}{(0.079 \pm 0.002)}$	$\frac{1.5 \pm 0.1}{-0.0}$ $\frac{-0.0}{(0.06 \pm 0.004)}$ $-0.000$	$\frac{2.5 \text{ max}}{(0.098 \text{ max})}$	$\frac{0.6 \text{ max}}{(0.024 \text{ max})}$	$\frac{4.0 \pm 0.1}{(0.157 \pm 0.004)}$
1812	$\frac{3.6 \pm 0.2}{(0.142 \pm 0.008)}$	$\frac{4.9 \pm 0.3}{(0.193 \pm 0.008)}$	$\frac{12.0 \pm 0.3}{(0.472 \pm 0.012)}$	$\frac{5.6 \pm 0.1}{(0.221 \pm 0.004)}$	$\frac{1.75 \pm 0.1}{(0.069 \pm 0.004)}$	$\frac{4.0 \pm 0.1}{(0.157 \pm 0.004)}$	$\frac{2.0 \pm 0.05}{(0.079 \pm 0.002)}$	$\frac{1.5 \pm 0.1}{-0.0}$ $\frac{-0.0}{(0.06 \pm 0.004)}$ $-0.000$	$\frac{3.8 \text{ max}}{(0.150 \text{ max})}$	$\frac{0.6 \text{ max}}{(0.024 \text{ max})}$	$\frac{8.0 \pm 0.1}{(0.315 \pm 0.004)}$

## ENVIRONMENTAL CHARACTERISTICS

NO	ITEM	PERFORMANCE	TEST CONDITION			
1	APPEARANCE	NO ABNORMAL EXTERIOR APPEARANCE	THROUGH MICROSCOPE (X10)			
2	INSULATION RESISTANCE	10,000M OR 500M $\mu$ F PRODUCT WHICHEVER IS SMALLER (RATED VOLTAGE IS BELOW 16V: 10,000M OR 100M $\mu$ F)	RATED VOLTAGE SHALL BE APPLIED. MEASUREMENT TIME IS 60 - 120 RATED VOLTAGE TIME 60 SEC .			
3	WITHSTANDING VOLTAGE	NO DIELECTRIC BREAKDOWN OR MECHANICAL BREAKDOWN	CLASS I : 300% OF THE RATED VOLTAGE FOR 1-5 SEC. CLASS II: 250% OF THE RATED VOLTAGE FOR 1-5 SEC IS APPLIED WITH LESS THAN 50mA CURRENT			
4	CAPACITANCE	CLASS I WITHIN THE SPECIFIED TOLERANCE	CAPACITANCE	FREQUENCY	VOLTAGE	
			1,000pF AND BELOW	1MHZ $\pm$ 10%	0.5 - 5 Vrms	
		MORE THAN 1,000 pF	1kHz $\pm$ 10%			
		CLASS II WITHIN THE SPECIFIED TOLERANCE	CAPACITANCE	FREQUENCY	VOLTAGE	
4.7 $\mu$ F AND BELOW	1kHz $\pm$ 10%		1.0 $\pm$ 0.2Vrms			
		MORE THAN 4.7 $\mu$ F	120HZ $\pm$ 20%	1.0 $\pm$ 0.2Vrms		
5	Q	CLASS I OVER 30pF : Q 1,000 LESS THAN 30pF: Q 400 +20C (C: CAPACITANCE)	CAPACITANCE	FREQUENCY	VOLTAGE	
			1,000pF AND BELOW	1MHZ $\pm$ 10%	0.5 - 5 Vrms	
			MORE THAN 1,000 pF	1kHz $\pm$ 10%		
6	DISSIPATION FACTOR (Tan $\theta$ CLASS II)	CLASS II	<b>X7R, X6S, X5R</b>			
			Rated Voltage	D.F.	Exception of D.F.	
			$\geq$ 50V	$\leq$ 2.5%	$\leq$ 3%	0201 (50V); 0603 $\geq$ 0.047 $\mu$ F 0805 $\geq$ 0.22 $\mu$ F; 1206 $\geq$ 0.47 $\mu$ F
					$\leq$ 5%	0603 $\geq$ 1 $\mu$ F; 0805 $\geq$ 1 $\mu$ F; 1206 $\geq$ 4.7 $\mu$ F; 1210 $\geq$ 4.7 $\mu$ F
			25V	$\leq$ 2.5%	$\leq$ 5%	0201 $\geq$ 0.01 $\mu$ F; 0805 $\geq$ 1 $\mu$ F; 1210 $\geq$ 4.7 $\mu$ F
					$\leq$ 10%	0402 $\geq$ 0.10 $\mu$ F; 0603 $\geq$ 0.33 $\mu$ F; 0805 $\geq$ 2.2 $\mu$ F 1206 $\geq$ 4.7 $\mu$ F; 1210 $\geq$ 22 $\mu$ F
			16V	$\leq$ 3.5%	$\leq$ 5%	0201 $\geq$ 0.01 $\mu$ F; 0402 $\geq$ 0.033 $\mu$ F; 0805 $\geq$ 0.68 $\mu$ F; 1206 $\geq$ 2.2 $\mu$ F; 1210 $\geq$ 4.7 $\mu$ F
					$\leq$ 10%	0402 $\geq$ 0.47 $\mu$ F; 0603 $\geq$ 0.68 $\mu$ F; 0805 $\geq$ 2.2 $\mu$ F; 1206 $\geq$ 4.7 $\mu$ F; 1210 $\geq$ 22 $\mu$ F
			10V	$\leq$ 5%	$\leq$ 10%	0402 $\geq$ 0.33 $\mu$ F; 0603 $\geq$ 0.33 $\mu$ F; 0805 $\geq$ 2.2 $\mu$ F; 1206 $\geq$ 2.2 $\mu$ F; 1210 $\geq$ 22 $\mu$ F
			6.3V	$\leq$ 10%		
			<b>Y5V, Z5U</b>			
			Rated Voltage	D.F.	Exception of D.F.	
			$\geq$ 50V	$\leq$ 5%	$\leq$ 9%	0603 $\geq$ 0.1 $\mu$ F; 0805 $\geq$ 0.47 $\mu$ F; 1206 $\geq$ 4.7 $\mu$ F;
			25V	$\leq$ 5%	$\leq$ 9%	0402 $\geq$ 0.047 $\mu$ F; 0603 $\geq$ 0.1 $\mu$ F; 0805 $\geq$ 0.33 $\mu$ F; 1206 $\geq$ 1 $\mu$ F; 1210 $\geq$ 4.7 $\mu$ F
$\leq$ 12.5%	0603 $\geq$ 2.2 $\mu$ F; 0805 $\geq$ 3.3 $\mu$ F; 1206 $\geq$ 10 $\mu$ F; 1210 $\geq$ 22 $\mu$ F; 1812 $\geq$ 47 $\mu$ F					
16V	$\leq$ 9%	$\leq$ 16%	0603 $\geq$ 2.2 $\mu$ F; 0805 $\geq$ 3.3 $\mu$ F; 1206 $\geq$ 4.7 $\mu$ F; 1210 $\geq$ 10 $\mu$ F; 1812 $\geq$ 47 $\mu$ F			
10V	$\leq$ 12.5%					
6.3V	$\leq$ 16%					

## ENVIRONMENTAL CHARACTERISTICS

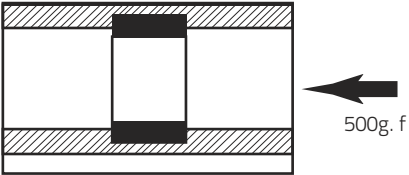
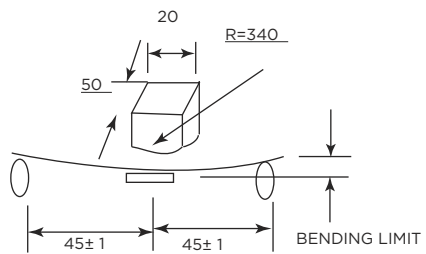
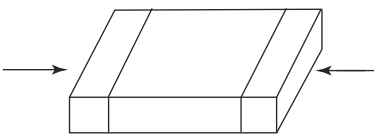
NO	ITEM		PERFORMANCE		TEST CONDITION				
			CHARACTERISTIC	TEMP. COEFFICIENT (PPM/°C)	THESE SYMMETRICAL TOLERANCE APPLY TO 2 POINT MEASUREMENT OF TEMPERATURE COEFFICIENT: ONE AT -25°C AND AT 85°C				
7	CAPACITANCE TEMPERATURE COEFFICIENT	CLASS I	COG/COG	0 ± 60 (±30)	STEP	TEMPERATURE (°C)			
				-150 ± 60	1	25 ± 2			
				-220 ± 60	2	MIN RATED TEMP ± 2			
				-330 ± 60	3	25 ± 2			
				-470 ± 60	4	MAX RATED TEMP ± 2			
				-750 ± 120	5	25 ± 2			
				+350 - -1000					
8	TEMPERATURE CHARACTERISTICS	CLASS II	CAPACITANCE CHANGE		STEP	TEMP. (°C) B	TEMP. (°C) F		
			CHAR.	CAP. CHANGE (%)				1	25 ± 2
			X	X7R	±15%	2	-55 ± 2	-25 ± 2	
				X6S	±22%				
			Y	X5R	±15%	3	25 ± 2	25 ± 2	
				Y5V	-82% - +22%				
				Z5U	-56% - +22%	4	125 ± 2	85 ± 2	
						5	25 ± 2	25 ± 2	
					$\frac{C2 - C1}{C1} \times 100\%$ C1: CAPACITANCE AT STANDARD TEMPERATURE (25°C) C2: CAPACITANCE AT EACH TEMPERATURE				
9	ADHESIVE STRENGTH OF TERMINATION		NO INDICATION OF PEELING SHALL OCCUR ON THE TERMINAL ELECTRODE		A 500g.f PRESSURE SHALL BE APPLIED FOR 10±1 SECOND 				
10	BENDING STRENGTH	APPEARANCE	NO MECHANICAL DAMAGE SHALL OCCURE		BENDING SHALL BE APPLIED TO THE LIMIT (1mm) WITH 0.3mm/SEC				
		CAPACITANCE	CHARACTER	CHANGE OF CAPACITANCE					
			CLASS I		WITHIN ±5% OR ±0.5pF WHICHEVER IS LARGER				
			CLASS II		WITHIN ±12.5%				
			X (X7R, X6S, X5R)	WITHIN ±12.5%					
			Y (Y5V, Z5U)	WITHIN ±30%					
11	SOLDERABILITY		MORE THAN 75% OF THE TERMINAL SURFACE IS TO BE SOLDERED NEWLY, SO METAL PART (A) DOES NOT COME OUT OR DISSOLVE 		SOLDER TEMPERATURE: 245 ± 5 °C SOLDER: Sn_Ag3_0.5Cu FLUX: RMA Type PRE-HEATING: AT 80 - 120 °C FOR 10 - 30 SEC.				

## ENVIRONMENTAL CHARACTERISTICS

NO	ITEM	PERFORMANCE	TEST CONDITION									
12	RESISTANCE TO SOLDERING HEAT	APPEARANCE	NO MECHANICAL DAMAGE SHALL OCCUR									
		CAPACITANCE	CHARACTERISTIC	CAP. CHANGE								
			CLASS I	WITHIN ±2.5% OR ±0.25 pF WHICHEVER IS LARGER								
			CLASS II	X	WITHIN ±7.5%							
				Y	WITHIN ±20%							
		QCLASS I	30 pF AND OVER: Q 1000 LESS THAN 30 pF: Q 400 + 20xC									
		Tan CLASS II	TO SATISFY THE SPECIFIED INITIAL VALUE									
		INSULATION RESISTANCE	TO SATISFY THE SPECIFIED INITIAL VALUE									
WITHSTANDING VOLTAGE	TO SATISFY THE SPECIFIED INITIAL VALUE											
13	VIBRATION TEST	APPEARANCE	NO MECHANICAL DAMAGE SHALL OCCUR									
		CAPACITANCE	CHARACTERISTIC	CAP. CHANGE								
			CLASS I	WITHIN ±2.5% OR ±0.25 pF WHICHEVER IS LARGER								
			CLASS II	X	WITHIN ±5%							
				Y	WITHIN ±20%							
		QCLASS I	30 pF AND OVER: Q 1000 LESS THAN 30 pF: Q 400 + 20xC									
		Tan CLASS II	TO SATISFY THE SPECIFIED INITIAL VALUE									
INSULATION RESISTANCE	TO SATISFY THE SPECIFIED INITIAL VALUE											
			<p>DIP : SOLDER TEMPERATURE OF 270± 5 °C  DIP TIME :10±1 SEC.  EACH TERMINATION SHALL BE FULLY IMMERSSED AND PREHEATED AS FOLLOWING:</p> <table border="1"> <thead> <tr> <th>STEP</th> <th>TEMP. (°C)</th> <th>TIME (SEC.)</th> </tr> </thead> <tbody> <tr> <td>1</td> <td>80-100</td> <td>60</td> </tr> <tr> <td>2</td> <td>150-180</td> <td>60</td> </tr> </tbody> </table> <p>MEASURE AT ROOM TEMP. AFTER COOLING FOR  CLASS I : 24 ± 2 HOURS  CLASS II : 48 ± 4 HOURS</p>	STEP	TEMP. (°C)	TIME (SEC.)	1	80-100	60	2	150-180	60
STEP	TEMP. (°C)	TIME (SEC.)										
1	80-100	60										
2	150-180	60										
			<p>THE CAPACITOR SHALL BE SUBJECTED TO A HARMONIC MOTION HAVING A TOTAL AMPLITUDE of 1.5mm</p> <p>THE ENTIRE FREQUENCY RANGE, FROM 10 TO 55Hz AND RETURN TO 10Hz SHALL BE TRAVERSED IN 1 MINUTE.</p> <p>THIS CYCLE SHALL BE PERFORMED 2 HOURS IN EACH THREE MUTUALLY PERPENDICULAR DIRECTION, FOR TOTAL PERIOD of 6 HOURS.</p>									

**ENVIRONMENTAL CHARACTERISTICS**

NO	ITEM	PERFORMANCE	TEST CONDITION			
14	APPEARANCE	NO MECHANICAL DAMAGE SHALL OCCUR	TEMPERATURE : 40±2 °C RELATIVE HUMIDITY: 90-95 %RH TEST TIME : 500 +12/-0 Hr.  MEASURE AT ROOM TEMPERATURE AFTER COOLING FOR CLASS I : 24±2 Hr. CLASS II : 48±4 Hr.  SEE (FIG.3)			
	CAPACITANCE	CHARACTERISTIC		CAPACITANCE CHANGE		
		CLASS I		WITHIN ±5% OR±0.5pF WHICHEVER IS LARGER		
		CLASS II		X	WITHIN ±12.5%	
				Y	WITHIN ±30%	
	QCLASS I	30pF AND OVER : Q 350 10 - 30pF : Q 275 + 2.5xC LESS THAN 10pF : Q 200 + 10xC				
	DISSIPATION FACTOR (Tanθ CLASS II)	<b>X7R, X6S, X5R</b>				
		Rated Voltage		D.F.	Exception of D.F.	
		≥50V		≤2.5%	≤3%	0201 (50V); 0603≥0.047uF 0805≥0.22uF; 1206≥0.47uF
					≤5%	0603≥1uF; 0805≥1uF; 1206≥4.7uF; 1210≥4.7uF
25V		≤2.5%	≤5%	0201≥0.01uF; 0805≥1uF; 1210≥4.7uF		
			≤10%	0402≥0.10uF; 0603≥0.33uF; 0805≥2.2uF 1206≥4.7uF; 1210≥22uF		
16V		≤3.5%	≤5%	0201≥0.01uF; 0402≥0.033uF; 0805≥0.68uF; 1206≥2.2uF; 1210≥4.7uF		
			≤10%	0402≥0.47uF; 0603≥0.68uF; 0805≥2.2uF; 1206≥4.7uF; 1210≥22uF		
10V		≤5%	≤10%	0402≥0.33uF; 0603≥0.33uF; 0805≥2.2uF; 1206≥2.2uF; 1210≥22uF		
6.3V		≤10%				
<b>Y5V, Z5U</b>						
Rated Voltage	D.F.	Exception of D.F.				
≥50V	≤5%	≤9%	0603≥0.1uF; 0805≥0.47uF; 1206≥4.7uF;			
25V	≤5%	≤9%	0402≥0.047uF; 0603≥0.1uF; 0805≥0.33uF; 1206≥1uF; 1210≥4.7uF			
16V	≤9%	≤12.5%	0603≥2.2uF; 0805≥3.3uF; 1206≥10uF; 1210≥22uF; 1812≥47uF			
10V	≤12.5%	≤16%	0603≥2.2uF; 0805≥3.3uF; 1206≥4.7uF; 1210≥10uF; 1812≥47uF			
6.3V	≤16%					
INSULATION RESISTANCE	MINIMUM INSULATION RESISTANCE: 1,000M OR 50M μF PRODUCT WHICHEVER IS SMALLER					

## ENVIRONMENTAL CHARACTERISTICS

NO	ITEM	PERFORMANCE	TEST CONDITION			
15	APPEARANCE	NO MECHANICAL DAMAGE SHALL OCCUR	APPLIED VOLTAGE: RATED VOLTAGE TEMPERATURE : 40±2 °C RELATIVE HUMIDITY: 90-95%RH TEST TIME : 500 +12/-0 Hr. CURRENT APPLIED: 50mA MAX.  MEASURING AT ROOM TEMPERATURE AFTER COOLING FOR CLASS I : 24±2 Hr. CLASS II : 48±4 Hr.  SEE (FIG.3)			
	CAPACITANCE	CHARACTERISTIC		CAPACITANCE CHANGE		
		CLASS I		WITHIN ±7.5% OR±0.75pF WHICHEVER IS LARGER		
		CLASS II		X	WITHIN ±12.5%	
	Y			WITHIN ±30%		
	QCLASS I	30pF AND OVER : Q 200 30pF AND BELOW : Q 100 + 10/3xC				
	DISSIPATION FACTOR (Tanθ CLASS II)	<b>X7R, X6S, X5R</b>				
		Rated Voltage		D.F.	Exception of D.F.	
		≥50V		≤2.5%	≤3%	0201 (50V); 0603≥0.047uF 0805≥0.22uF; 1206≥0.47uF
					≤5%	0603≥1uF; 0805≥1uF; 1206≥4.7uF; 1210≥4.7uF
25V		≤2.5%	≤5%	0201≥0.01uF; 0805≥1uF; 1210≥4.7uF		
			≤10%	0402≥0.10uF; 0603≥0.33uF; 0805≥2.2uF 1206≥4.7uF; 1210≥22uF		
16V		≤3.5%	≤5%	0201≥0.01uF; 0402≥0.033uF; 0805≥0.68uF; 1206≥2.2uF; 1210≥4.7uF		
			≤10%	0402≥0.47uF; 0603≥0.68uF; 0805≥2.2uF; 1206≥4.7uF; 1210≥22uF		
10V		≤5%	≤10%	0402≥0.33uF; 0603≥0.33uF; 0805≥2.2uF; 1206≥2.2uF; 1210≥22uF		
6.3V	≤10%					
<b>Y5V, Z5U</b>						
Rated Voltage	D.F.	Exception of D.F.				
≥50V	≤5%	≤9%	0603≥0.1uF; 0805≥0.47uF; 1206≥4.7uF;			
25V	≤5%	≤9%	0402≥0.047uF; 0603≥0.1uF; 0805≥0.33uF; 1206≥1uF; 1210≥4.7uF			
		≤12.5%	0603≥2.2uF; 0805≥3.3uF; 1206≥10uF; 1210≥22uF; 1812≥47uF			
10V	≤12.5%	≤16%	0603≥2.2uF; 0805≥3.3uF; 1206≥4.7uF; 1210≥10uF; 1812≥47uF			
6.3V	≤16%					
INSULATION RESISTANCE	MINIMUM INSULATION RESISTANCE: 100 M OR 25M μF PRODUCT, WHICHEVER IS SMALLER					

## ENVIRONMENTAL CHARACTERISTICS

NO	ITEM	PERFORMANCE	TEST CONDITION			
16	APPEARANCE	NO MECHANICAL DAMAGE SHALL OCCUR	APPLIED VOLTAGE: 200% OF RATED VOLTAGE TEST TIME : 1000 +48/-0 Hr. CURRENT APPLIED: 50mA MAX.			
	CAPACITANCE	CHARACTERISTIC		CAP. CHANGE		
		CLASS I		WITHIN ±3% OR ±0.3pF, WHICHEVER IS LARGER		
		CLASS II		X	WITHIN ±12.5%	
	Y		WITHIN ±30%			
	QCLASS I	30pF AND OVER : Q 350 10 - 30 pF : Q 275 + 2.5xC LESS THAN 10pF :Q 200 + 10xC	CLASS I 125 ±3 °C			
	DISSIPATION FACTOR (Tanθ CLASS II)	<b>X7R, X6S, X5R</b>		(INITIAL VALUE MEASUREMENT) FOR CLASS II CAPACITORS, 200 % OF RATED VOLTAGE SHALL BE APPLIED FOR 1 HOUR AT THE MAXIMUM OPERATING TEMPERATURE, THEN KEEP IT AT ROOM TEMPERATURE FOR 48 ±4 HRS.  SEE (FIG.3)		
		Rated Voltage	D.F.		Exception of D.F.	
		≥50V	≤2.5%		≤3%	0201 (50V); 0603≥0.047uF 0805≥0.22uF; 1206≥0.47uF
					≤5%	0603≥1uF; 0805≥1uF; 1206≥4.7uF; 1210≥4.7uF
25V		≤2.5%	≤5%		0201≥0.01uF; 0805≥1uF; 1210≥4.7uF	
			≤10%		0402≥0.10uF; 0603≥0.33uF; 0805≥2.2uF 1206≥4.7uF; 1210≥22uF	
16V		≤3.5%	≤5%		0201≥0.01uF; 0402≥0.033uF; 0805≥0.68uF; 1206≥2.2uF; 1210≥4.7uF	
			≤10%		0402≥0.47uF; 0603≥0.68uF; 0805≥2.2uF; 1206≥4.7uF; 1210≥22uF	
10V		≤5%	≤10%		0402≥0.33uF; 0603≥0.33uF; 0805≥2.2uF; 1206≥2.2uF; 1210≥22uF	
6.3V		≤10%				
<b>Y5V, Z5U</b>						
Rated Voltage	D.F.	Exception of D.F.				
≥50V	≤5%	≤9%	0603≥0.1uF; 0805≥0.47uF; 1206≥4.7uF;			
25V	≤5%	≤9%	0402≥0.047uF; 0603≥0.1uF; 0805≥0.33uF; 1206≥1uF; 1210≥4.7uF			
16V	≤9%	≤12.5%	0603≥2.2uF; 0805≥3.3uF; 1206≥10uF; 1210≥22uF; 1812≥47uF			
10V	≤12.5%	≤16%	0603≥2.2uF; 0805≥3.3uF; 1206≥4.7uF; 1210≥10uF; 1812≥47uF			
6.3V	≤16%					
INSULATION RESISTANCE	MINIMUM INSULATION RESISTANCE: 1,000M OR 50M μF PRODUCT WHICHEVER IS SMALLER					

## ENVIRONMENTAL CHARACTERISTICS

NO	ITEM	PERFORMANCE	TEST CONDITION															
17	TEMPERATURE CYCLE	APPEARANCE	<p>CAPACITORS SHALL BE SUBJECTED TO FIVE CYCLES OF THE TEMPERATURE CYCLE AS FOLLOWING</p> <table border="1"> <thead> <tr> <th>STEP</th> <th>TEMP.(°C)</th> <th>TIME (MIN)</th> </tr> </thead> <tbody> <tr> <td>1</td> <td>MIN. RATED TEMP. +0/-3</td> <td>30</td> </tr> <tr> <td>2</td> <td>25</td> <td>2 - 3</td> </tr> <tr> <td>3</td> <td>MAX. RATED TEMP. +3/-0</td> <td>30</td> </tr> <tr> <td>4</td> <td>25</td> <td>2 - 3</td> </tr> </tbody> </table> <p>MEASURE AT ROOM TEMPERATURE AFTER COOLING FOR CLASS I : 24±2 Hr. CLASS II : 48±4 Hr. SEE(FIG.3)</p>	STEP	TEMP.(°C)	TIME (MIN)	1	MIN. RATED TEMP. +0/-3	30	2	25	2 - 3	3	MAX. RATED TEMP. +3/-0	30	4	25	2 - 3
		STEP		TEMP.(°C)	TIME (MIN)													
		1		MIN. RATED TEMP. +0/-3	30													
		2		25	2 - 3													
		3		MAX. RATED TEMP. +3/-0	30													
		4		25	2 - 3													
		NO MECHANICAL DAMAGE SHALL OCCUR																
		CAPACITANCE		CHARACTERISTIC	CAP. CHANGE													
				CLASS I		WITHIN ±2.5% OR ±0.25pF WHICHEVER IS LARGER												
				CLASS II	X	WITHIN ±7.5%												
Y	WITHIN ±20%																	
QCLASS I	30 pF AND OVER : Q 1000 LESS THAN 30pF:Q 400 +20xC																	
TAN CLASS II	<b>X7R, X6S, X5R</b>																	
	Rated Voltage	D.F.	Exception of D.F.															
	≥50V	≤2.5%	≤3%	0201 (50V); 0603≥0.047uF 0805≥0.22uF; 1206≥0.47uF														
			≤5%	0603≥1uF; 0805≥1uF; 1206≥4.7uF; 1210≥4.7uF														
	25V	≤2.5%	≤5%	0201≥0.01uF; 0805≥1uF; 1210≥4.7uF														
			≤10%	0402≥0.10uF; 0603≥0.33uF; 0805≥2.2uF 1206≥4.7uF; 1210≥22uF														
	16V	≤3.5%	≤5%	0201≥0.01uF; 0402≥0.033uF; 0805≥0.68uF; 1206≥2.2uF; 1210≥4.7uF														
			≤10%	0402≥0.47uF; 0603≥0.68uF; 0805≥2.2uF; 1206≥4.7uF; 1210≥22uF														
	10V	≤5%	≤10%	0402≥0.33uF; 0603≥0.33uF; 0805≥2.2uF; 1206≥2.2uF; 1210≥22uF														
	6.3V	≤10%																
	<b>Y5V, Z5U</b>																	
	Rated Voltage	D.F.	Exception of D.F.															
	≥50V	≤5%	≤9%	0603≥0.1uF; 0805≥0.47uF; 1206≥4.7uF;														
	25V	≤5%	≤9%	0402≥0.047uF; 0603≥0.1uF; 0805≥0.33uF; 1206≥1uF; 1210≥4.7uF														
16V	≤9%	≤12.5%	0603≥2.2uF; 0805≥3.3uF; 1206≥10uF; 1210≥22uF; 1812≥47uF															
10V	≤12.5%	≤16%	0603≥2.2uF; 0805≥3.3uF; 1206≥4.7uF; 1210≥10uF; 1812≥47uF															
6.3V	≤16%																	
INSULATION RESISTANCE	TO SATISFY THE SPECIFIED INITIAL VALUE																	

**ENVIRONMENTAL CHARACTERISTICS**

NO	ITEM	TEST CONDITION	REQUIREMENTS																																																																																																																			
18	HIGH TEMPERATURE Load-Endurance (Life Testing)	<p>*Test Temperature: COG, X7R/X7S: 125±3°C X5R, Y5V: 85±3°C Test time: 1000+24/-0 hrs. <b>Endurance or Life Test Voltage (RVLL)</b> * All components are tested at 100% of rated voltage (Vr) for the below range:</p> <table border="1"> <thead> <tr> <th>SIZE</th> <th>DIELECTRIC</th> <th>RATED VOLTAGE</th> <th>CAPACITANCE</th> </tr> </thead> <tbody> <tr> <td rowspan="2">0201</td> <td rowspan="2">X5R/X7R/X6S</td> <td>≤10V</td> <td>C≥0.1µF</td> </tr> <tr> <td>≥16V</td> <td>C&gt;0.1µF</td> </tr> <tr> <td rowspan="6">0402</td> <td rowspan="2">X5R</td> <td>≤16V</td> <td>C&gt;0.1µF</td> </tr> <tr> <td>25V, 50V</td> <td>C≥0.1µF</td> </tr> <tr> <td rowspan="2">X6S</td> <td>6.3V, 10V</td> <td>C&gt;0.1µF</td> </tr> <tr> <td>16V, 25V</td> <td>C≥0.1µF</td> </tr> <tr> <td rowspan="2">X7R/X7S/Y5V</td> <td>25V</td> <td>C≥0.1µF</td> </tr> <tr> <td>35V</td> <td>C≥0.1µF</td> </tr> <tr> <td rowspan="3">0603</td> <td rowspan="2">X5R/X7R/X6S/X7S</td> <td>4V</td> <td>C≥22µF</td> </tr> <tr> <td>6.3V, 10V</td> <td>C≥4.7µF</td> </tr> <tr> <td>X5R/X7R/X6S</td> <td>25V</td> <td>C≥0.1µF</td> </tr> <tr> <td>X7R</td> <td>35V</td> <td>C≥0.1µF</td> </tr> <tr> <td rowspan="4">0805</td> <td rowspan="3">X5R/X7R/X6S/X7S</td> <td>4V</td> <td>C≥47µF</td> </tr> <tr> <td>6.3V</td> <td>C≥22µF</td> </tr> <tr> <td>10V, 50V</td> <td>C≥10µF</td> </tr> <tr> <td>X7R/X6S</td> <td>16V, 25V</td> <td>C≥10µF</td> </tr> <tr> <td>X5R</td> <td></td> <td>C≥22µF</td> </tr> <tr> <td>1206</td> <td>X5R/X7R/X6S</td> <td>≤6.3V</td> <td>C≥47µF</td> </tr> <tr> <td rowspan="2">1210</td> <td rowspan="2">X5R/X7R/X6S</td> <td>16V</td> <td>C≥47µF</td> </tr> <tr> <td>X7R</td> <td>100V</td> <td>C≥43.3µF</td> </tr> </tbody> </table> <p>*Any items outside this range or with a different dielectric will hold the following test conditions: (1) ≤ 6.3V or C ≥ 10µF : 150% of rated voltage. (2) 10V ≤ Vr ≤ 100V: 200% of rated voltage.</p>	SIZE	DIELECTRIC	RATED VOLTAGE	CAPACITANCE	0201	X5R/X7R/X6S	≤10V	C≥0.1µF	≥16V	C>0.1µF	0402	X5R	≤16V	C>0.1µF	25V, 50V	C≥0.1µF	X6S	6.3V, 10V	C>0.1µF	16V, 25V	C≥0.1µF	X7R/X7S/Y5V	25V	C≥0.1µF	35V	C≥0.1µF	0603	X5R/X7R/X6S/X7S	4V	C≥22µF	6.3V, 10V	C≥4.7µF	X5R/X7R/X6S	25V	C≥0.1µF	X7R	35V	C≥0.1µF	0805	X5R/X7R/X6S/X7S	4V	C≥47µF	6.3V	C≥22µF	10V, 50V	C≥10µF	X7R/X6S	16V, 25V	C≥10µF	X5R		C≥22µF	1206	X5R/X7R/X6S	≤6.3V	C≥47µF	1210	X5R/X7R/X6S	16V	C≥47µF	X7R	100V	C≥43.3µF	<p>• No remarkable damage. CAP CHANGE: COG: ±3.0% or ±0.3pF whichever is larger X7R, X5R, X6S, X7S: ≥10V**, within ±12.5%; ≤6.3V within ±25%; **10V: 0603≥4.7µF; 0402≥1.0µF; 0201≥0.1µF, within ±25% Y5V≥10V, within ±30%; ≤6.3V, within +30/-40% Q/D.F. VALUE: COG: More than 30pF, Q≥350 10pF≤30pF, Q≥275+2.5C Less than 10pF, Q≥200+10C</p> <p><b>X7R, X5R, X6S, X7S:</b></p> <table border="1"> <thead> <tr> <th>RATED VOLTAGE</th> <th>D.F.</th> <th colspan="2">EXCEPTIONS OF D.F. ≤</th> </tr> </thead> <tbody> <tr> <td rowspan="3">≥100V</td> <td rowspan="3">≤3%</td> <td>≤6%</td> <td>1206≥0.47µF</td> </tr> <tr> <td>≤7.5%</td> <td>0603≥0.068µF; 0805&gt;0.1µF; 1206≥1µF; 1210≥2.2µF</td> </tr> <tr> <td>≤20%</td> <td>0805&gt;2.2µF; 1210≤3.3µF</td> </tr> <tr> <td rowspan="2">50V</td> <td rowspan="2">≤3%</td> <td>≤6%</td> <td>0201(50V); 0603&gt;0.047µF; 0805≥0.18µF; 1206≥0.47µF</td> </tr> <tr> <td>≤10%</td> <td>0201≥0.01µF; 1210≥3.3µF</td> </tr> <tr> <td rowspan="2">35V</td> <td rowspan="2">≤5%</td> <td>≤20%</td> <td>0402≥0.012µF; 0603&gt;0.1µF; 0805≥1.0µF (0805/X7R&gt;0.47µF); 1206≥2.2µF; 1210≥10µF</td> </tr> <tr> <td>≤20%</td> <td>0603≥1.0µF; 0805≥2.2µF; 1206≥2.2µF; 1210≥10µF</td> </tr> <tr> <td rowspan="3">25V</td> <td rowspan="3">≤5%</td> <td>≤10%</td> <td>0201=0.01µF; 0805≥1.0µF; 1210≥10µF</td> </tr> <tr> <td>≤14%</td> <td>0603≥0.33µF</td> </tr> <tr> <td>≤15%</td> <td>0201&gt;0.01µF; 0402&gt;0.10µF (0402/X7R≥0.056µF); 0603&gt;0.47µF; 0805≥2.2µF; 1206≥0.47µF; 1210≥22µF (1210/X5R≥10µF)</td> </tr> <tr> <td rowspan="2">16V</td> <td rowspan="2">≤5%</td> <td>≤10%</td> <td>0603≥0.15µF; 0805≥0.68µF; 1206≥2.2µF; 1210≥4.7µF</td> </tr> <tr> <td>≤15%</td> <td>0201≥0.01µF (0201/X7R≥0.022µF); 0402≥0.033µF 0603&gt;0.47µF; 0805≥2.2µF; 1206≥4.7µF; 1210≥22µF</td> </tr> <tr> <td rowspan="2">10V</td> <td rowspan="2">≤7.5%</td> <td>≤15%</td> <td>0201≥0.012µF; 0402≥0.22µF; 0603≥0.33µF; 0805≥2.2µF; 1206≥2.2µF; 1210≥22µF</td> </tr> <tr> <td>≤20%</td> <td>0201≥0.01µF; 0402≥1.0µF; 0603/X5R≥10µF; 01R5/X5R</td> </tr> <tr> <td>6.3V</td> <td>≤15%</td> <td>≤30%</td> <td>0201≥0.01µF; 0402≥1.0µF (0402/X6S≥0.47µF); 0603≥10µF; 0805≥4.7µF; 1206≥47µF; 1210≥100µF</td> </tr> <tr> <td>4V</td> <td>≤20%</td> <td>-</td> <td>-</td> </tr> </tbody> </table>	RATED VOLTAGE	D.F.	EXCEPTIONS OF D.F. ≤		≥100V	≤3%	≤6%	1206≥0.47µF	≤7.5%	0603≥0.068µF; 0805>0.1µF; 1206≥1µF; 1210≥2.2µF	≤20%	0805>2.2µF; 1210≤3.3µF	50V	≤3%	≤6%	0201(50V); 0603>0.047µF; 0805≥0.18µF; 1206≥0.47µF	≤10%	0201≥0.01µF; 1210≥3.3µF	35V	≤5%	≤20%	0402≥0.012µF; 0603>0.1µF; 0805≥1.0µF (0805/X7R>0.47µF); 1206≥2.2µF; 1210≥10µF	≤20%	0603≥1.0µF; 0805≥2.2µF; 1206≥2.2µF; 1210≥10µF	25V	≤5%	≤10%	0201=0.01µF; 0805≥1.0µF; 1210≥10µF	≤14%	0603≥0.33µF	≤15%	0201>0.01µF; 0402>0.10µF (0402/X7R≥0.056µF); 0603>0.47µF; 0805≥2.2µF; 1206≥0.47µF; 1210≥22µF (1210/X5R≥10µF)	16V	≤5%	≤10%	0603≥0.15µF; 0805≥0.68µF; 1206≥2.2µF; 1210≥4.7µF	≤15%	0201≥0.01µF (0201/X7R≥0.022µF); 0402≥0.033µF 0603>0.47µF; 0805≥2.2µF; 1206≥4.7µF; 1210≥22µF	10V	≤7.5%	≤15%	0201≥0.012µF; 0402≥0.22µF; 0603≥0.33µF; 0805≥2.2µF; 1206≥2.2µF; 1210≥22µF	≤20%	0201≥0.01µF; 0402≥1.0µF; 0603/X5R≥10µF; 01R5/X5R	6.3V	≤15%	≤30%	0201≥0.01µF; 0402≥1.0µF (0402/X6S≥0.47µF); 0603≥10µF; 0805≥4.7µF; 1206≥47µF; 1210≥100µF	4V	≤20%	-	-
		SIZE	DIELECTRIC	RATED VOLTAGE	CAPACITANCE																																																																																																																	
		0201	X5R/X7R/X6S	≤10V	C≥0.1µF																																																																																																																	
				≥16V	C>0.1µF																																																																																																																	
		0402	X5R	≤16V	C>0.1µF																																																																																																																	
				25V, 50V	C≥0.1µF																																																																																																																	
			X6S	6.3V, 10V	C>0.1µF																																																																																																																	
				16V, 25V	C≥0.1µF																																																																																																																	
			X7R/X7S/Y5V	25V	C≥0.1µF																																																																																																																	
				35V	C≥0.1µF																																																																																																																	
		0603	X5R/X7R/X6S/X7S	4V	C≥22µF																																																																																																																	
				6.3V, 10V	C≥4.7µF																																																																																																																	
			X5R/X7R/X6S	25V	C≥0.1µF																																																																																																																	
		X7R	35V	C≥0.1µF																																																																																																																		
		0805	X5R/X7R/X6S/X7S	4V	C≥47µF																																																																																																																	
				6.3V	C≥22µF																																																																																																																	
				10V, 50V	C≥10µF																																																																																																																	
			X7R/X6S	16V, 25V	C≥10µF																																																																																																																	
X5R		C≥22µF																																																																																																																				
1206	X5R/X7R/X6S	≤6.3V	C≥47µF																																																																																																																			
1210	X5R/X7R/X6S	16V	C≥47µF																																																																																																																			
		X7R	100V	C≥43.3µF																																																																																																																		
RATED VOLTAGE	D.F.	EXCEPTIONS OF D.F. ≤																																																																																																																				
≥100V	≤3%	≤6%	1206≥0.47µF																																																																																																																			
		≤7.5%	0603≥0.068µF; 0805>0.1µF; 1206≥1µF; 1210≥2.2µF																																																																																																																			
		≤20%	0805>2.2µF; 1210≤3.3µF																																																																																																																			
50V	≤3%	≤6%	0201(50V); 0603>0.047µF; 0805≥0.18µF; 1206≥0.47µF																																																																																																																			
		≤10%	0201≥0.01µF; 1210≥3.3µF																																																																																																																			
35V	≤5%	≤20%	0402≥0.012µF; 0603>0.1µF; 0805≥1.0µF (0805/X7R>0.47µF); 1206≥2.2µF; 1210≥10µF																																																																																																																			
		≤20%	0603≥1.0µF; 0805≥2.2µF; 1206≥2.2µF; 1210≥10µF																																																																																																																			
25V	≤5%	≤10%	0201=0.01µF; 0805≥1.0µF; 1210≥10µF																																																																																																																			
		≤14%	0603≥0.33µF																																																																																																																			
		≤15%	0201>0.01µF; 0402>0.10µF (0402/X7R≥0.056µF); 0603>0.47µF; 0805≥2.2µF; 1206≥0.47µF; 1210≥22µF (1210/X5R≥10µF)																																																																																																																			
16V	≤5%	≤10%	0603≥0.15µF; 0805≥0.68µF; 1206≥2.2µF; 1210≥4.7µF																																																																																																																			
		≤15%	0201≥0.01µF (0201/X7R≥0.022µF); 0402≥0.033µF 0603>0.47µF; 0805≥2.2µF; 1206≥4.7µF; 1210≥22µF																																																																																																																			
10V	≤7.5%	≤15%	0201≥0.012µF; 0402≥0.22µF; 0603≥0.33µF; 0805≥2.2µF; 1206≥2.2µF; 1210≥22µF																																																																																																																			
		≤20%	0201≥0.01µF; 0402≥1.0µF; 0603/X5R≥10µF; 01R5/X5R																																																																																																																			
6.3V	≤15%	≤30%	0201≥0.01µF; 0402≥1.0µF (0402/X6S≥0.47µF); 0603≥10µF; 0805≥4.7µF; 1206≥47µF; 1210≥100µF																																																																																																																			
4V	≤20%	-	-																																																																																																																			

**ENVIRONMENTAL CHARACTERISTICS**

NO	ITEM	TEST CONDITION	REQUIREMENTS																																																		
18	HIGH TEMPERATURE Load-Endurance (Life Testing)	(3) 150% of rated voltage for below range.	<ul style="list-style-type: none"> <li>No remarkable damage.</li> <li>CAP CHANGE: COG: <math>\pm 3.0\%</math> or <math>\pm 0.3\text{pF}</math> whichever is larger X7R, X5R, X6S, X7S: <math>\geq 10\text{V}^{**}</math>, within <math>\pm 12.5\%</math>; <math>\leq 6.3\text{V}</math> within <math>\pm 25\%</math> **10V: 0603<math>\geq 4.7\mu\text{F}</math>; 0402<math>\geq 1.0\mu\text{F}</math>; 0201<math>\geq 0.1\mu\text{F}</math>, within <math>\pm 25\%</math> Y5V<math>\geq 10\text{V}</math>, within <math>\pm 30\%</math>; <math>\leq 6.3\text{V}</math>, within <math>+30\%/-40\%</math></li> <li>Q/D.F. VALUE: COG: More than 30pF, Q<math>\geq 350</math> 10pF<math>\leq 30\text{pF}</math>, Q<math>\geq 275+2.5\text{C}</math> Less than 10pF, Q<math>\geq 200+10\text{C}</math></li> </ul>																																																		
		SIZE		DIELECTRIC	RATED VOLTAGE	CAPACITANCE																																															
		0201		X5R/X6S	16V, 25V	C $\geq 0.1\mu\text{F}$																																															
				X7R	16V	C $\geq 0.022\mu\text{F}$																																															
		0402		X7R/X5R/X6S	50V	C $\geq 0.01\mu\text{F}$																																															
					10-25V	C $\geq 0.22\mu\text{F}$																																															
				Y5V	16V	C $\geq 0.47\mu\text{F}$																																															
						C $\geq 0.22\mu\text{F}$																																															
		0603		X7S	50-100V	C $> 0.22\mu\text{F}$																																															
					50V	C $> 0.1\mu\text{F}$																																															
				X7R	25V	C=1.0 $\mu\text{F}$																																															
				X5R	50V	C $\geq 1.0\mu\text{F}$																																															
				X5R/X7R/X6S/X7S	10V, 16V	C $\geq 1.0\mu\text{F}$																																															
		0805		Y5V	16V	C $\geq 2.2\mu\text{F}$																																															
					100V	C $\geq 0.47\mu\text{F}$																																															
					50V	C $\geq 0.68\mu\text{F}$																																															
					35V	C $\geq 2.2\mu\text{F}$																																															
		1206		X5R/X7R/X6S/X7S	10-25V	C $\geq 4.7\mu\text{F}$																																															
100V	C $\geq 1.0\mu\text{F}$																																																				
50V	C=4.7 $\mu\text{F}$																																																				
100V	C $> 1.0\mu\text{F}$																																																				
1210	X5R/X6S/X7S	50V	C=4.7 $\mu\text{F}$																																																		
		50-100V	C $\geq 2.2\mu\text{F}$																																																		
1825 2220 2225	X7R	100-250V	C $\geq 1.0\mu\text{F}$																																																		
<p>* Before initial measurement (Class II only): To apply de-aging at 150 °C for 1 hr then set for 24<math>\pm</math>2 hrs at room temp</p> <p>* Cap./DF(Q)/I.R. Measurement to be made after de-aging at 150 °C for 1hr then set for 24<math>\pm</math>2hrs at room temp.</p> <p>** De-rating conditions:</p>			<p><b>Y5V:</b></p> <table border="1"> <thead> <tr> <th>RATED VOLTAGE</th> <th>D.F.</th> <th colspan="2">EXCEPTIONS OF D.F. <math>\leq</math></th> </tr> </thead> <tbody> <tr> <td><math>\geq 0\text{V}</math></td> <td><math>\leq 7.5\%</math></td> <td><math>\leq 10\%</math></td> <td>0603<math>\geq 0.1\mu\text{F}</math>; 0805<math>\geq 0.47\mu\text{F}</math>; 1206<math>\geq 4.7\mu\text{F}</math></td> </tr> <tr> <td></td> <td></td> <td><math>\leq 20\%</math></td> <td>1210<math>\geq 6.8\mu\text{F}</math></td> </tr> <tr> <td>35V</td> <td><math>\leq 10\%</math></td> <td>-</td> <td>-</td> </tr> <tr> <td rowspan="2">25V</td> <td rowspan="2"><math>\leq 7.5\%</math></td> <td><math>\leq 10\%</math></td> <td>0402<math>\geq 0.047\mu\text{F}</math>; 0603<math>\geq 0.1\mu\text{F}</math>; 0805<math>\geq 0.33\mu\text{F}</math>; 1206<math>\geq 1.0\mu\text{F}</math>; 1210<math>\geq 4.7\mu\text{F}</math></td> </tr> <tr> <td><math>\leq 15\%</math></td> <td>0402<math>\geq 0.068\mu\text{F}</math>; 0603<math>\geq 0.47\mu\text{F}</math>; 1206<math>\geq 4.7\mu\text{F}</math>; 1210<math>\geq 22\mu\text{F}</math></td> </tr> <tr> <td rowspan="2">16V (C<math>&lt; 1.0\mu\text{F}</math>)</td> <td rowspan="2"><math>\leq 10\%</math></td> <td><math>\leq 12.5\%</math></td> <td>0402<math>\geq 0.068\mu\text{F}</math>; 0603<math>\geq 0.68\mu\text{F}</math></td> </tr> <tr> <td><math>\leq 20\%</math></td> <td>0402<math>\geq 0.22\mu\text{F}</math></td> </tr> <tr> <td>16V (C<math>\geq 1.0\mu\text{F}</math>)</td> <td><math>\leq 12.5\%</math></td> <td><math>\leq 20\%</math></td> <td>0603<math>\geq 2.2\mu\text{F}</math>; 0805<math>\geq 3.3\mu\text{F}</math>; 1206<math>\geq 10\mu\text{F}</math>; 1210<math>\geq 22\mu\text{F}</math>; 1812<math>\geq 47\mu\text{F}</math></td> </tr> <tr> <td>10V</td> <td><math>\leq 20\%</math></td> <td><math>\leq 30\%</math></td> <td>0402<math>\geq 0.47\mu\text{F}</math></td> </tr> <tr> <td>6.3V</td> <td><math>\leq 30\%</math></td> <td>-</td> <td>-</td> </tr> </tbody> </table> <p>*I.R.: <math>\geq 10\text{V}</math>, 1G<math>\Omega</math> or 50Q-F whichever is smaller. Class II (X7R, X5R, X6S, X7S, Y5V)</p> <table border="1"> <thead> <tr> <th>RATED VOLTAGE</th> <th>INSULATION RESISTANCE</th> </tr> </thead> <tbody> <tr> <td>100V: All X7R; 1210<math>\geq 3.3\mu\text{F}</math></td> <td rowspan="7">1G<math>\Omega</math> or apply <math>\geq 10\Omega\text{-F}</math> rule, whichever is smaller.</td> </tr> <tr> <td>50V: 0402<math>&gt; 0.01\mu\text{F}</math>; 0603<math>\geq 1.0\mu\text{F}</math>; 0805<math>\geq 1.0\mu\text{F}</math>; 1206<math>\geq 4.7\mu\text{F}</math>; 1210<math>\geq 4.7\mu\text{F}</math></td> </tr> <tr> <td>35V: 0603<math>\geq 1.0\mu\text{F}</math>; 0805<math>\geq 2.2\mu\text{F}</math>; 1206<math>\geq 2.2\mu\text{F}</math>; 1210<math>\geq 10\mu\text{F}</math></td> </tr> <tr> <td>25V: 0201<math>\geq 0.1\mu\text{F}</math>; 0402<math>\geq 0.22\mu\text{F}</math>; 0603<math>\geq 2.2\mu\text{F}</math>; 0805<math>\geq 2.2\mu\text{F}</math>; 1206<math>\geq 10\mu\text{F}</math>; 1210<math>\geq 10\mu\text{F}</math></td> </tr> <tr> <td>16V: 0201<math>\geq 0.1\mu\text{F}</math>; 0402<math>\geq 0.22\mu\text{F}</math>; 0603<math>\geq 1.0\mu\text{F}</math>; 0805<math>\geq 2.2\mu\text{F}</math>; 1206<math>\geq 10\mu\text{F}</math>; 1210<math>\geq 47\mu\text{F}</math></td> </tr> <tr> <td>10V: 0201<math>\geq 47\text{nF}</math>; 0402<math>\geq 0.47\mu\text{F}</math>; 0603<math>\geq 0.47\mu\text{F}</math>; 0805<math>\geq 2.2\mu\text{F}</math>; 1206<math>\geq 4.7\mu\text{F}</math>; 1210<math>\geq 47\mu\text{F}</math></td> </tr> <tr> <td>6.3V; 4V : All X6S/X7S items, Size<math>\geq 1812</math></td> </tr> </tbody> </table>	RATED VOLTAGE	D.F.	EXCEPTIONS OF D.F. $\leq$		$\geq 0\text{V}$	$\leq 7.5\%$	$\leq 10\%$	0603 $\geq 0.1\mu\text{F}$ ; 0805 $\geq 0.47\mu\text{F}$ ; 1206 $\geq 4.7\mu\text{F}$			$\leq 20\%$	1210 $\geq 6.8\mu\text{F}$	35V	$\leq 10\%$	-	-	25V	$\leq 7.5\%$	$\leq 10\%$	0402 $\geq 0.047\mu\text{F}$ ; 0603 $\geq 0.1\mu\text{F}$ ; 0805 $\geq 0.33\mu\text{F}$ ; 1206 $\geq 1.0\mu\text{F}$ ; 1210 $\geq 4.7\mu\text{F}$	$\leq 15\%$	0402 $\geq 0.068\mu\text{F}$ ; 0603 $\geq 0.47\mu\text{F}$ ; 1206 $\geq 4.7\mu\text{F}$ ; 1210 $\geq 22\mu\text{F}$	16V (C $< 1.0\mu\text{F}$ )	$\leq 10\%$	$\leq 12.5\%$	0402 $\geq 0.068\mu\text{F}$ ; 0603 $\geq 0.68\mu\text{F}$	$\leq 20\%$	0402 $\geq 0.22\mu\text{F}$	16V (C $\geq 1.0\mu\text{F}$ )	$\leq 12.5\%$	$\leq 20\%$	0603 $\geq 2.2\mu\text{F}$ ; 0805 $\geq 3.3\mu\text{F}$ ; 1206 $\geq 10\mu\text{F}$ ; 1210 $\geq 22\mu\text{F}$ ; 1812 $\geq 47\mu\text{F}$	10V	$\leq 20\%$	$\leq 30\%$	0402 $\geq 0.47\mu\text{F}$	6.3V	$\leq 30\%$	-	-	RATED VOLTAGE	INSULATION RESISTANCE	100V: All X7R; 1210 $\geq 3.3\mu\text{F}$	1G $\Omega$ or apply $\geq 10\Omega\text{-F}$ rule, whichever is smaller.	50V: 0402 $> 0.01\mu\text{F}$ ; 0603 $\geq 1.0\mu\text{F}$ ; 0805 $\geq 1.0\mu\text{F}$ ; 1206 $\geq 4.7\mu\text{F}$ ; 1210 $\geq 4.7\mu\text{F}$	35V: 0603 $\geq 1.0\mu\text{F}$ ; 0805 $\geq 2.2\mu\text{F}$ ; 1206 $\geq 2.2\mu\text{F}$ ; 1210 $\geq 10\mu\text{F}$	25V: 0201 $\geq 0.1\mu\text{F}$ ; 0402 $\geq 0.22\mu\text{F}$ ; 0603 $\geq 2.2\mu\text{F}$ ; 0805 $\geq 2.2\mu\text{F}$ ; 1206 $\geq 10\mu\text{F}$ ; 1210 $\geq 10\mu\text{F}$	16V: 0201 $\geq 0.1\mu\text{F}$ ; 0402 $\geq 0.22\mu\text{F}$ ; 0603 $\geq 1.0\mu\text{F}$ ; 0805 $\geq 2.2\mu\text{F}$ ; 1206 $\geq 10\mu\text{F}$ ; 1210 $\geq 47\mu\text{F}$	10V: 0201 $\geq 47\text{nF}$ ; 0402 $\geq 0.47\mu\text{F}$ ; 0603 $\geq 0.47\mu\text{F}$ ; 0805 $\geq 2.2\mu\text{F}$ ; 1206 $\geq 4.7\mu\text{F}$ ; 1210 $\geq 47\mu\text{F}$	6.3V; 4V : All X6S/X7S items, Size $\geq 1812$
RATED VOLTAGE	D.F.	EXCEPTIONS OF D.F. $\leq$																																																			
$\geq 0\text{V}$	$\leq 7.5\%$	$\leq 10\%$		0603 $\geq 0.1\mu\text{F}$ ; 0805 $\geq 0.47\mu\text{F}$ ; 1206 $\geq 4.7\mu\text{F}$																																																	
		$\leq 20\%$		1210 $\geq 6.8\mu\text{F}$																																																	
35V	$\leq 10\%$	-		-																																																	
25V	$\leq 7.5\%$	$\leq 10\%$		0402 $\geq 0.047\mu\text{F}$ ; 0603 $\geq 0.1\mu\text{F}$ ; 0805 $\geq 0.33\mu\text{F}$ ; 1206 $\geq 1.0\mu\text{F}$ ; 1210 $\geq 4.7\mu\text{F}$																																																	
		$\leq 15\%$		0402 $\geq 0.068\mu\text{F}$ ; 0603 $\geq 0.47\mu\text{F}$ ; 1206 $\geq 4.7\mu\text{F}$ ; 1210 $\geq 22\mu\text{F}$																																																	
16V (C $< 1.0\mu\text{F}$ )	$\leq 10\%$	$\leq 12.5\%$		0402 $\geq 0.068\mu\text{F}$ ; 0603 $\geq 0.68\mu\text{F}$																																																	
		$\leq 20\%$		0402 $\geq 0.22\mu\text{F}$																																																	
16V (C $\geq 1.0\mu\text{F}$ )	$\leq 12.5\%$	$\leq 20\%$		0603 $\geq 2.2\mu\text{F}$ ; 0805 $\geq 3.3\mu\text{F}$ ; 1206 $\geq 10\mu\text{F}$ ; 1210 $\geq 22\mu\text{F}$ ; 1812 $\geq 47\mu\text{F}$																																																	
10V	$\leq 20\%$	$\leq 30\%$		0402 $\geq 0.47\mu\text{F}$																																																	
6.3V	$\leq 30\%$	-		-																																																	
RATED VOLTAGE	INSULATION RESISTANCE																																																				
100V: All X7R; 1210 $\geq 3.3\mu\text{F}$	1G $\Omega$ or apply $\geq 10\Omega\text{-F}$ rule, whichever is smaller.																																																				
50V: 0402 $> 0.01\mu\text{F}$ ; 0603 $\geq 1.0\mu\text{F}$ ; 0805 $\geq 1.0\mu\text{F}$ ; 1206 $\geq 4.7\mu\text{F}$ ; 1210 $\geq 4.7\mu\text{F}$																																																					
35V: 0603 $\geq 1.0\mu\text{F}$ ; 0805 $\geq 2.2\mu\text{F}$ ; 1206 $\geq 2.2\mu\text{F}$ ; 1210 $\geq 10\mu\text{F}$																																																					
25V: 0201 $\geq 0.1\mu\text{F}$ ; 0402 $\geq 0.22\mu\text{F}$ ; 0603 $\geq 2.2\mu\text{F}$ ; 0805 $\geq 2.2\mu\text{F}$ ; 1206 $\geq 10\mu\text{F}$ ; 1210 $\geq 10\mu\text{F}$																																																					
16V: 0201 $\geq 0.1\mu\text{F}$ ; 0402 $\geq 0.22\mu\text{F}$ ; 0603 $\geq 1.0\mu\text{F}$ ; 0805 $\geq 2.2\mu\text{F}$ ; 1206 $\geq 10\mu\text{F}$ ; 1210 $\geq 47\mu\text{F}$																																																					
10V: 0201 $\geq 47\text{nF}$ ; 0402 $\geq 0.47\mu\text{F}$ ; 0603 $\geq 0.47\mu\text{F}$ ; 0805 $\geq 2.2\mu\text{F}$ ; 1206 $\geq 4.7\mu\text{F}$ ; 1210 $\geq 47\mu\text{F}$																																																					
6.3V; 4V : All X6S/X7S items, Size $\geq 1812$																																																					
<p><b>DERATING CURVE</b></p>																																																					

### ADHESIVE STRENGTH OF TERMINATION

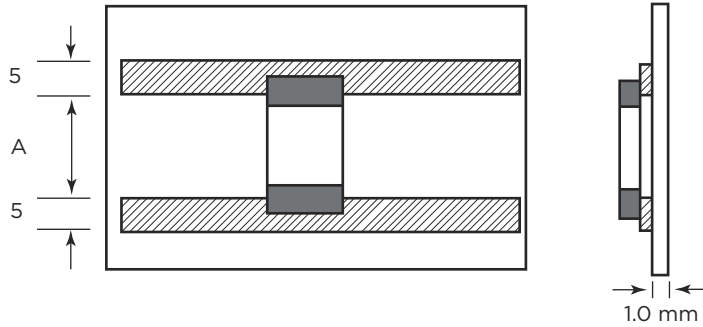

CODE	DIMENSION (mm)	A (mm)	CODE	DIMENSION (mm)	A (mm)
01005 (0402)	0.40 x 0.20	0.12	1206 (3216)	3.2 x 1.6	2.2
0201 (0603)	0.61 x 0.31	0.2	1210 (3225)	3.2 x 2.5	2.2
0402 (1005)	1.0 x 0.5	0.4	1812 (4532)	4.5 x 3.2	3.5
0603 (1608)	1.6 x 0.8	1.0	2220 (5750)	5.7 x 5.08	4.7
0805 (2012)	2.0 x 1.25	1.2			

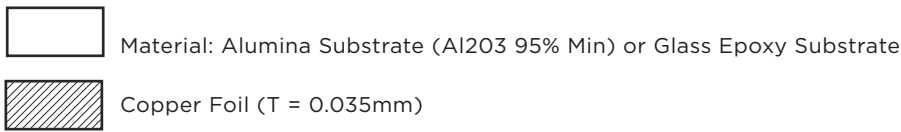

### SUBSTRATE BENDING STRENGTH

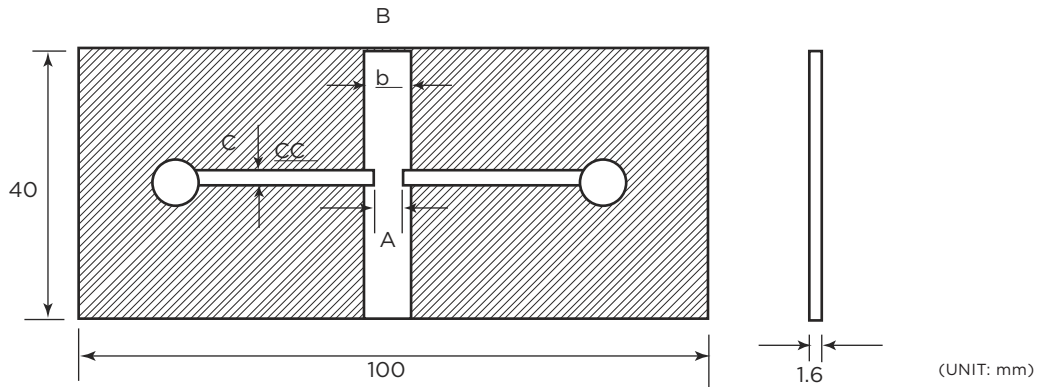

CODE	DIMENSION (mm)	A (mm)	B (mm)	C (mm)
01005 (0402)	0.40 x 0.20	0.12	0.7	0.20
0201 (0603)	0.61 x 0.31	0.2	1.0	0.4
0402 (1005)	1.0 x 0.5	0.4	1.4	0.5
0603 (1608)	1.6 x 0.8	1.0	3.0	1.0
0805 (2012)	2.0 x 1.25	1.2	4.0	1.65
1206 (3216)	3.2 x 1.6	2.2	5.0	2.0
1210 (3225)	3.2 x 2.5	2.2	5.0	3.2
1812 (4532)	4.5 x 3.2	3.5	7.0	4.0
2220 (5750)	5.7 x 5.08	4.7	8.5	5.0



**TEST SUBSTRATE**

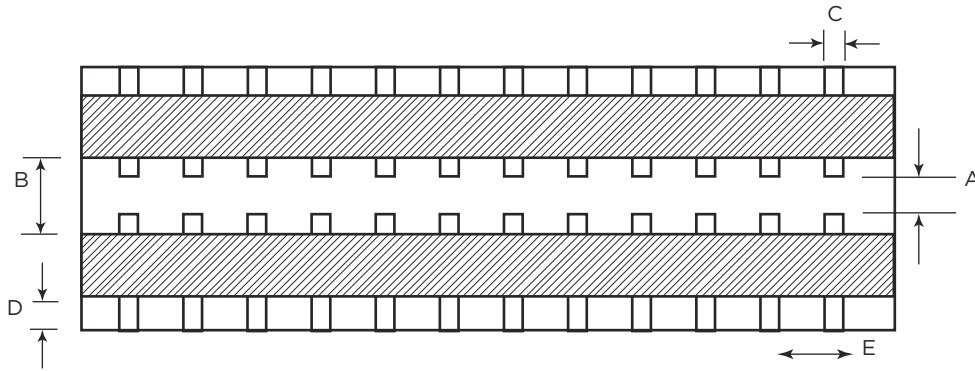

(UNIT: mm)

CODE	DIMENSION (MM)	A	B	C	D	E
0201 (0603)	0.61 x 0.31	0.2	1.0	0.4	7.5	3.6
0402 (1005)	1.0 x 0.5	0.4	1.4	0.5	7.5	3.8
0603 (1608)	1.6 x 0.8	1.0	3.0	0.7	7.5	4.0
0805 (2012)	2.0 x 1.25	1.2	4.0	1.0	7.5	4.2
1206 (3216)	3.2 x 1.6	2.2	5.0	1.3	7.5	4.6
1210 (3225)	3.2 x 2.5	2.2	5.0	2.0	7.5	5.5
1812 (4532)	4.5 x 3.2	3.5	7.0	2.7	7.5	6.2
2220 (5750)	5.7 x 5.08	4.7	8.5	3.4	7.5	7.0

MATERIAL: GLASS EPOXY SUBSTRATE



COPPER FOIL ( t = 0.035mm)



SOLDER RESIST

## Looking for pricing, stock, or lifecycle information?

Click below to explore more details on WIN SOURCE:

 [View C1206X5R100-107MNE on WIN SOURCE](#)

 [Venkel Information](#)

## Optimize Your Supply Chain with WIN SOURCE Solutions

-  Global Sourcing Solution
-  Obsolete Management
-  Cost Control Management
-  Shortage Management
-  Alternative Solution
-  Excess Inventory Management